



U.S. Department
of Transportation
**Federal Aviation
Administration**

August 15, 2019

Aeronautical

Information

Manual

Official Guide to
Basic Flight Information and ATC Procedures

An electronic version of this publication is available online at
http://www.faa.gov/air_traffic/publications

Record of Changes

Change Number	Change Filed	Comments

Aeronautical Information Manual

Explanation of Changes

Effective: August 15, 2019

a. 2-3-15. Security Identifications Display Area (Airport Ramp Area)

This change clarifies the Security Identifications Display Area (SIDA), other types of security related areas on an airport, and the requirements of security identification.

b. 4-1-21. Airport Reservation Operations and Special Traffic Management Programs

This change removes the telephone user information from the AIM due to the phone-based CVRS system not being serviceable.

c. 4-3-18. Taxiing

7-3-1. General

7-3-2. Vortex Generation

7-3-3. Vortex Strength

7-3-4. Vortex Behavior

7-3-5. Operations Problem Areas

7-3-8. Pilot Responsibility

7-3-9. Air Traffic Wake Turbulence Separations

7-3-10. Development and New Capabilities

This change updates and adds clarity regarding wake turbulence information.

d. 5-2-3. IFR Clearances Off Uncontrolled Airports

This change addresses the removal of the dedicated hotline and the phone number MEDEVAC pilots may contact for their clearances.

e. 7-1-20. Pilot Weather Reports (PIREPs)

This change directs users to the current version of Advisory Circular 00-45H for additional detailed information on PIREPs.

f. Editorial Changes

Editorial changes include a universal AWSS change, NTAP references in 5-1-11, *RP terminology in 4-3-3, and references to MEDEVAC.

g. Entire publication.

Editorial/format changes were made where necessary. Revision bars were not used when changes are insignificant in nature.

Checklist of Pages

PAGE	DATE
Cover	8/15/19
Record of Changes	N/A
Exp of Chg-1	8/15/19
Checklist of Pages	
CK-1	8/15/19
CK-2	8/15/19
CK-3	8/15/19
CK-4	8/15/19
CK-5	8/15/19
CK-6	8/15/19
Subscription Info	8/15/19
Comments/Corr	8/15/19
Comments/Corr	8/15/19
Basic Flight Info	8/15/19
Publication Policy	8/15/19
Reg & Advis Cir	8/15/19
Table of Contents	
i	8/15/19
ii	8/15/19
iii	8/15/19
iv	8/15/19
v	8/15/19
vi	8/15/19
vii	8/15/19
viii	8/15/19
ix	8/15/19
x	8/15/19
xi	8/15/19
Chapter 1. Air Navigation	
Section 1. Navigation Aids	
1-1-1	8/15/19
1-1-2	8/15/19
1-1-3	8/15/19
1-1-4	8/15/19
1-1-5	8/15/19
1-1-6	8/15/19
1-1-7	8/15/19
1-1-8	8/15/19
1-1-9	8/15/19
1-1-10	8/15/19
1-1-11	8/15/19

PAGE	DATE
1-1-12	8/15/19
1-1-13	8/15/19
1-1-14	8/15/19
1-1-15	8/15/19
1-1-16	8/15/19
1-1-17	8/15/19
1-1-18	8/15/19
1-1-19	8/15/19
1-1-20	8/15/19
1-1-21	8/15/19
1-1-22	8/15/19
1-1-23	8/15/19
1-1-24	8/15/19
1-1-25	8/15/19
1-1-26	8/15/19
1-1-27	8/15/19
1-1-28	8/15/19
1-1-29	8/15/19
1-1-30	8/15/19
1-1-31	8/15/19
1-1-32	8/15/19
1-1-33	8/15/19
1-1-34	8/15/19
1-1-35	8/15/19
1-1-36	8/15/19
Section 2. Performance-Based Navigation (PBN) and Area Navigation (RNAV)	
1-2-1	8/15/19
1-2-2	8/15/19
1-2-3	8/15/19
1-2-4	8/15/19
1-2-5	8/15/19
1-2-6	8/15/19
1-2-7	8/15/19
1-2-8	8/15/19
1-2-9	8/15/19
1-2-10	8/15/19

PAGE	DATE
Chapter 2. Aeronautical Lighting and Other Airport Visual Aids	
Section 1. Airport Lighting Aids	
2-1-1	8/15/19
2-1-2	8/15/19
2-1-3	8/15/19
2-1-4	8/15/19
2-1-5	8/15/19
2-1-6	8/15/19
2-1-7	8/15/19
2-1-8	8/15/19
2-1-9	8/15/19
2-1-10	8/15/19
2-1-11	8/15/19
2-1-12	8/15/19
2-1-13	8/15/19
2-1-14	8/15/19
2-1-15	8/15/19
Section 2. Air Navigation and Obstruction Lighting	
2-2-1	8/15/19
2-2-2	8/15/19
Section 3. Airport Marking Aids and Signs	
2-3-1	8/15/19
2-3-2	8/15/19
2-3-3	8/15/19
2-3-4	8/15/19
2-3-5	8/15/19
2-3-6	8/15/19
2-3-7	8/15/19
2-3-8	8/15/19
2-3-9	8/15/19
2-3-10	8/15/19
2-3-11	8/15/19
2-3-12	8/15/19
2-3-13	8/15/19
2-3-14	8/15/19
2-3-15	8/15/19
2-3-16	8/15/19
2-3-17	8/15/19
2-3-18	8/15/19
2-3-19	8/15/19
2-3-20	8/15/19
2-3-21	8/15/19

Checklist of Pages

PAGE	DATE
2-3-22	8/15/19
2-3-23	8/15/19
2-3-24	8/15/19
2-3-25	8/15/19
2-3-26	8/15/19
2-3-27	8/15/19
2-3-28	8/15/19
2-3-29	8/15/19
2-3-30	8/15/19
2-3-31	8/15/19
Chapter 3. Airspace	
Section 1. General	
3-1-1	8/15/19
3-1-2	8/15/19
3-1-3	8/15/19
Section 2. Controlled Airspace	
3-2-1	8/15/19
3-2-2	8/15/19
3-2-3	8/15/19
3-2-4	8/15/19
3-2-5	8/15/19
3-2-6	8/15/19
3-2-7	8/15/19
3-2-8	8/15/19
3-2-9	8/15/19
3-2-10	8/15/19
Section 3. Class G Airspace	
3-3-1	8/15/19
Section 4. Special Use Airspace	
3-4-1	8/15/19
3-4-2	8/15/19
3-4-3	8/15/19
Section 5. Other Airspace Areas	
3-5-1	8/15/19
3-5-2	8/15/19
3-5-3	8/15/19
3-5-4	8/15/19
3-5-5	8/15/19
3-5-6	8/15/19
3-5-7	8/15/19
3-5-8	8/15/19
3-5-9	8/15/19

PAGE	DATE
3-5-10	8/15/19
Chapter 4. Air Traffic Control	
Section 1. Services Available to Pilots	
4-1-1	8/15/19
4-1-2	8/15/19
4-1-3	8/15/19
4-1-4	8/15/19
4-1-5	8/15/19
4-1-6	8/15/19
4-1-7	8/15/19
4-1-8	8/15/19
4-1-9	8/15/19
4-1-10	8/15/19
4-1-11	8/15/19
4-1-12	8/15/19
4-1-13	8/15/19
4-1-14	8/15/19
4-1-15	8/15/19
4-1-16	8/15/19
4-1-17	8/15/19
4-1-18	8/15/19
4-1-19	8/15/19
Section 2. Radio Communications Phraseology and Techniques	
4-2-1	8/15/19
4-2-2	8/15/19
4-2-3	8/15/19
4-2-4	8/15/19
4-2-5	8/15/19
4-2-6	8/15/19
4-2-7	8/15/19
4-2-8	8/15/19
Section 3. Airport Operations	
4-3-1	8/15/19
4-3-2	8/15/19
4-3-3	8/15/19
4-3-4	8/15/19
4-3-5	8/15/19
4-3-6	8/15/19
4-3-7	8/15/19
4-3-8	8/15/19
4-3-9	8/15/19
4-3-10	8/15/19

PAGE	DATE
4-3-11	8/15/19
4-3-12	8/15/19
4-3-13	8/15/19
4-3-14	8/15/19
4-3-15	8/15/19
4-3-16	8/15/19
4-3-17	8/15/19
4-3-18	8/15/19
4-3-19	8/15/19
4-3-20	8/15/19
4-3-21	8/15/19
4-3-22	8/15/19
4-3-23	8/15/19
4-3-24	8/15/19
4-3-25	8/15/19
4-3-26	8/15/19
4-3-27	8/15/19
4-3-28	8/15/19
4-3-29	8/15/19
4-3-30	8/15/19
4-3-31	8/15/19
4-3-32	8/15/19
Section 4. ATC Clearances and Aircraft Separation	
4-4-1	8/15/19
4-4-2	8/15/19
4-4-3	8/15/19
4-4-4	8/15/19
4-4-5	8/15/19
4-4-6	8/15/19
4-4-7	8/15/19
4-4-8	8/15/19
4-4-9	8/15/19
4-4-10	8/15/19
4-4-11	8/15/19
4-4-12	8/15/19
Section 5. Surveillance Systems	
4-5-1	8/15/19
4-5-2	8/15/19
4-5-3	8/15/19
4-5-4	8/15/19
4-5-5	8/15/19
4-5-6	8/15/19
4-5-7	8/15/19
4-5-8	8/15/19
4-5-9	8/15/19

Checklist of Pages

PAGE	DATE
4-5-10	8/15/19
4-5-11	8/15/19
4-5-12	8/15/19
4-5-13	8/15/19
4-5-14	8/15/19
4-5-15	8/15/19
4-5-16	8/15/19
4-5-17	8/15/19
4-5-18	8/15/19
4-5-19	8/15/19
4-5-20	8/15/19
4-5-21	8/15/19
Section 6. Operational Policy/ Procedures for Reduced Vertical Separation Minimum (RVSM) in the Domestic U.S., Alaska, Offshore Airspace and the San Juan FIR	
4-6-1	8/15/19
4-6-2	8/15/19
4-6-3	8/15/19
4-6-4	8/15/19
4-6-5	8/15/19
4-6-6	8/15/19
4-6-7	8/15/19
4-6-8	8/15/19
4-6-9	8/15/19
4-6-10	8/15/19
Section 7. Operational Policy/ Procedures for the Gulf of Mexico 50 NM Lateral Separation Initiative	
4-7-1	8/15/19
4-7-2	8/15/19
Chapter 5. Air Traffic Procedures	
Section 1. Preflight	
5-1-1	8/15/19
5-1-2	8/15/19
5-1-3	8/15/19
5-1-4	8/15/19
5-1-5	8/15/19
5-1-6	8/15/19
5-1-7	8/15/19
5-1-8	8/15/19

PAGE	DATE
5-1-9	8/15/19
5-1-10	8/15/19
5-1-11	8/15/19
5-1-12	8/15/19
5-1-13	8/15/19
5-1-14	8/15/19
5-1-15	8/15/19
5-1-16	8/15/19
5-1-17	8/15/19
5-1-18	8/15/19
5-1-19	8/15/19
5-1-20	8/15/19
5-1-21	8/15/19
5-1-22	8/15/19
5-1-23	8/15/19
5-1-24	8/15/19
5-1-25	8/15/19
5-1-26	8/15/19
5-1-27	8/15/19
5-1-28	8/15/19
5-1-29	8/15/19
5-1-30	8/15/19
5-1-31	8/15/19
Section 2. Departure Procedures	
5-2-1	8/15/19
5-2-2	8/15/19
5-2-3	8/15/19
5-2-4	8/15/19
5-2-5	8/15/19
5-2-6	8/15/19
5-2-7	8/15/19
5-2-8	8/15/19
5-2-9	8/15/19
5-2-10	8/15/19
5-2-11	8/15/19
5-2-12	8/15/19
5-2-13	8/15/19
Section 3. En Route Procedures	
5-3-1	8/15/19
5-3-2	8/15/19
5-3-3	8/15/19
5-3-4	8/15/19
5-3-5	8/15/19
5-3-6	8/15/19

PAGE	DATE
5-3-7	8/15/19
5-3-8	8/15/19
5-3-9	8/15/19
5-3-10	8/15/19
5-3-11	8/15/19
5-3-12	8/15/19
5-3-13	8/15/19
5-3-14	8/15/19
5-3-15	8/15/19
5-3-16	8/15/19
5-3-17	8/15/19
5-3-18	8/15/19
5-3-19	8/15/19
5-3-20	8/15/19
5-3-21	8/15/19
5-3-22	8/15/19
5-3-23	8/15/19
5-3-24	8/15/19
5-3-25	8/15/19
5-3-26	8/15/19
5-3-27	8/15/19
5-3-28	8/15/19
Section 4. Arrival Procedures	
5-4-1	8/15/19
5-4-2	8/15/19
5-4-3	8/15/19
5-4-4	8/15/19
5-4-5	8/15/19
5-4-6	8/15/19
5-4-7	8/15/19
5-4-8	8/15/19
5-4-9	8/15/19
5-4-10	8/15/19
5-4-11	8/15/19
5-4-12	8/15/19
5-4-13	8/15/19
5-4-14	8/15/19
5-4-15	8/15/19
5-4-16	8/15/19
5-4-17	8/15/19
5-4-18	8/15/19
5-4-19	8/15/19
5-4-20	8/15/19
5-4-21	8/15/19
5-4-22	8/15/19
5-4-23	8/15/19
5-4-24	8/15/19
5-4-25	8/15/19

Checklist of Pages

PAGE	DATE
5-4-26	8/15/19
5-4-27	8/15/19
5-4-28	8/15/19
5-4-29	8/15/19
5-4-30	8/15/19
5-4-31	8/15/19
5-4-32	8/15/19
5-4-33	8/15/19
5-4-34	8/15/19
5-4-35	8/15/19
5-4-36	8/15/19
5-4-37	8/15/19
5-4-38	8/15/19
5-4-39	8/15/19
5-4-40	8/15/19
5-4-41	8/15/19
5-4-42	8/15/19
5-4-43	8/15/19
5-4-44	8/15/19
5-4-45	8/15/19
5-4-46	8/15/19
5-4-47	8/15/19
5-4-48	8/15/19
5-4-49	8/15/19
5-4-50	8/15/19
5-4-51	8/15/19
5-4-52	8/15/19
5-4-53	8/15/19
5-4-54	8/15/19
5-4-55	8/15/19
5-4-56	8/15/19
5-4-57	8/15/19
5-4-58	8/15/19
5-4-59	8/15/19
5-4-60	8/15/19
5-4-61	8/15/19
5-4-62	8/15/19
5-4-63	8/15/19
5-4-64	8/15/19
Section 5. Pilot/Controller Roles and Responsibilities	
5-5-1	8/15/19
5-5-2	8/15/19
5-5-3	8/15/19
5-5-4	8/15/19
5-5-5	8/15/19
5-5-6	8/15/19
5-5-7	8/15/19
5-5-8	8/15/19

PAGE	DATE
Section 6. National Security and Interception Procedures	
5-6-1	8/15/19
5-6-2	8/15/19
5-6-3	8/15/19
5-6-4	8/15/19
5-6-5	8/15/19
5-6-6	8/15/19
5-6-7	8/15/19
5-6-8	8/15/19
5-6-9	8/15/19
5-6-10	8/15/19
5-6-11	8/15/19
5-6-12	8/15/19
5-6-13	8/15/19
5-6-14	8/15/19
Chapter 6. Emergency Procedures	
Section 1. General	
6-1-1	8/15/19
Section 2. Emergency Services Available to Pilots	
6-2-1	8/15/19
6-2-2	8/15/19
6-2-3	8/15/19
6-2-4	8/15/19
6-2-5	8/15/19
6-2-6	8/15/19
6-2-7	8/15/19
6-2-8	8/15/19
6-2-9	8/15/19
6-2-10	8/15/19
6-2-11	8/15/19
Section 3. Distress and Urgency Procedures	
6-3-1	8/15/19
6-3-2	8/15/19
6-3-3	8/15/19
6-3-4	8/15/19
6-3-5	8/15/19
6-3-6	8/15/19
6-3-7	8/15/19

PAGE	DATE
Section 4. Two-way Radio Communications Failure	
6-4-1	8/15/19
6-4-2	8/15/19
Section 5. Aircraft Rescue and Fire Fighting Communications	
6-5-1	8/15/19
6-5-2	8/15/19
Chapter 7. Safety of Flight	
Section 1. Meteorology	
7-1-1	8/15/19
7-1-2	8/15/19
7-1-3	8/15/19
7-1-4	8/15/19
7-1-5	8/15/19
7-1-6	8/15/19
7-1-7	8/15/19
7-1-8	8/15/19
7-1-9	8/15/19
7-1-10	8/15/19
7-1-11	8/15/19
7-1-12	8/15/19
7-1-13	8/15/19
7-1-14	8/15/19
7-1-15	8/15/19
7-1-16	8/15/19
7-1-17	8/15/19
7-1-18	8/15/19
7-1-19	8/15/19
7-1-20	8/15/19
7-1-21	8/15/19
7-1-22	8/15/19
7-1-23	8/15/19
7-1-24	8/15/19
7-1-25	8/15/19
7-1-26	8/15/19
7-1-27	8/15/19
7-1-28	8/15/19
7-1-29	8/15/19
7-1-30	8/15/19
7-1-31	8/15/19
7-1-32	8/15/19
7-1-33	8/15/19
7-1-34	8/15/19

Checklist of Pages

PAGE	DATE
7-1-35	8/15/19
7-1-36	8/15/19
7-1-37	8/15/19
7-1-38	8/15/19
7-1-39	8/15/19
7-1-40	8/15/19
7-1-41	8/15/19
7-1-42	8/15/19
7-1-43	8/15/19
7-1-44	8/15/19
7-1-45	8/15/19
7-1-46	8/15/19
7-1-47	8/15/19
7-1-48	8/15/19
7-1-49	8/15/19
7-1-50	8/15/19
7-1-51	8/15/19
7-1-52	8/15/19
7-1-53	8/15/19
7-1-54	8/15/19
7-1-55	8/15/19
7-1-56	8/15/19
7-1-57	8/15/19
7-1-58	8/15/19
7-1-59	8/15/19
7-1-60	8/15/19
7-1-61	8/15/19
7-1-62	8/15/19
7-1-63	8/15/19
7-1-64	8/15/19
7-1-65	8/15/19
7-1-66	8/15/19
7-1-67	8/15/19
7-1-68	8/15/19
7-1-69	8/15/19
7-1-70	8/15/19
7-1-71	8/15/19
Section 2. Altimeter Setting Procedures	
7-2-1	8/15/19
7-2-2	8/15/19
7-2-3	8/15/19
7-2-4	8/15/19
Section 3. Wake Turbulence	
7-3-1	8/15/19
7-3-2	8/15/19

PAGE	DATE
7-3-3	8/15/19
7-3-4	8/15/19
7-3-5	8/15/19
7-3-6	8/15/19
7-3-7	8/15/19
7-3-8	8/15/19
Section 4. Bird Hazards and Flight Over National Refuges, Parks, and Forests	
7-4-1	8/15/19
7-4-2	8/15/19
Section 5. Potential Flight Hazards	
7-5-1	8/15/19
7-5-2	8/15/19
7-5-3	8/15/19
7-5-4	8/15/19
7-5-5	8/15/19
7-5-6	8/15/19
7-5-7	8/15/19
7-5-8	8/15/19
7-5-9	8/15/19
7-5-10	8/15/19
7-5-11	8/15/19
7-5-12	8/15/19
7-5-13	8/15/19
7-5-14	8/15/19
Section 6. Safety, Accident, and Hazard Reports	
7-6-1	8/15/19
7-6-2	8/15/19
7-6-3	8/15/19
Chapter 8. Medical Facts for Pilots	
Section 1. Fitness for Flight	
8-1-1	8/15/19
8-1-2	8/15/19
8-1-3	8/15/19
8-1-4	8/15/19
8-1-5	8/15/19
8-1-6	8/15/19
8-1-7	8/15/19
8-1-8	8/15/19
8-1-9	8/15/19

PAGE	DATE
Chapter 9. Aeronautical Charts and Related Publications	
Section 1. Types of Charts Available	
9-1-1	8/15/19
9-1-2	8/15/19
9-1-3	8/15/19
9-1-4	8/15/19
9-1-5	8/15/19
9-1-6	8/15/19
9-1-7	8/15/19
9-1-8	8/15/19
9-1-9	8/15/19
9-1-10	8/15/19
9-1-11	8/15/19
9-1-12	8/15/19
9-1-13	8/15/19
Chapter 10. Helicopter Operations	
Section 1. Helicopter IFR Operations	
10-1-1	8/15/19
10-1-2	8/15/19
10-1-3	8/15/19
10-1-4	8/15/19
10-1-5	8/15/19
10-1-6	8/15/19
10-1-7	8/15/19
Section 2. Special Operations	
10-2-1	8/15/19
10-2-2	8/15/19
10-2-3	8/15/19
10-2-4	8/15/19
10-2-5	8/15/19
10-2-6	8/15/19
10-2-7	8/15/19
10-2-8	8/15/19
10-2-9	8/15/19
10-2-10	8/15/19
10-2-11	8/15/19
10-2-12	8/15/19
10-2-13	8/15/19
10-2-14	8/15/19
10-2-15	8/15/19
10-2-16	8/15/19
10-2-17	8/15/19

Checklist of Pages

PAGE	DATE
Appendices	
Appendix 1-1	8/15/19
Env	N/A
Appendix 2-1	8/15/19
Appendix 3-1	8/15/19
Appendix 3-2	8/15/19
Appendix 3-3	8/15/19
Appendix 3-4	8/15/19
Appendix 3-5	8/15/19
Pilot/Controller Glossary	
PCG-1	8/15/19
PCG-2	8/15/19
PCG A-1	8/15/19
PCG A-2	8/15/19
PCG A-3	8/15/19
PCG A-4	8/15/19
PCG A-5	8/15/19
PCG A-6	8/15/19
PCG A-7	8/15/19
PCG A-8	8/15/19
PCG A-9	8/15/19
PCG A-10	8/15/19
PCG A-11	8/15/19
PCG A-12	8/15/19
PCG A-13	8/15/19
PCG A-14	8/15/19
PCG A-15	8/15/19
PCG A-16	8/15/19
PCG B-1	8/15/19
PCG B-2	8/15/19
PCG C-1	8/15/19
PCG C-2	8/15/19
PCG C-3	8/15/19
PCG C-4	8/15/19
PCG C-5	8/15/19
PCG C-6	8/15/19
PCG C-7	8/15/19
PCG C-8	8/15/19
PCG C-9	8/15/19
PCG D-1	8/15/19
PCG D-2	8/15/19
PCG D-3	8/15/19
PCG D-4	8/15/19
PCG E-1	8/15/19
PCG E-2	8/15/19
PCG F-1	8/15/19
PCG F-2	8/15/19

PAGE	DATE
PCG F-3	8/15/19
PCG F-4	8/15/19
PCG F-5	8/15/19
PCG G-1	8/15/19
PCG G-2	8/15/19
PCG G-3	8/15/19
PCG H-1	8/15/19
PCG H-2	8/15/19
PCG H-3	8/15/19
PCG I-1	8/15/19
PCG I-2	8/15/19
PCG I-3	8/15/19
PCG I-4	8/15/19
PCG I-5	8/15/19
PCG I-6	8/15/19
PCG J-1	8/15/19
PCG K-1	8/15/19
PCG L-1	8/15/19
PCG L-2	8/15/19
PCG L-3	8/15/19
PCG M-1	8/15/19
PCG M-2	8/15/19
PCG M-3	8/15/19
PCG M-4	8/15/19
PCG M-5	8/15/19
PCG M-6	8/15/19
PCG N-1	8/15/19
PCG N-2	8/15/19
PCG N-3	8/15/19
PCG N-4	8/15/19
PCG O-1	8/15/19
PCG O-2	8/15/19
PCG O-3	8/15/19
PCG O-4	8/15/19
PCG P-1	8/15/19
PCG P-2	8/15/19
PCG P-3	8/15/19
PCG P-4	8/15/19
PCG P-5	8/15/19
PCG Q-1	8/15/19
PCG R-1	8/15/19
PCG R-2	8/15/19
PCG R-3	8/15/19
PCG R-4	8/15/19
PCG R-5	8/15/19
PCG R-6	8/15/19
PCG R-7	8/15/19
PCG R-8	8/15/19
PCG S-1	8/15/19

PAGE	DATE
PCG S-2	8/15/19
PCG S-3	8/15/19
PCG S-4	8/15/19
PCG S-5	8/15/19
PCG S-6	8/15/19
PCG S-7	8/15/19
PCG S-8	8/15/19
PCG S-9	8/15/19
PCG T-1	8/15/19
PCG T-2	8/15/19
PCG T-3	8/15/19
PCG T-4	8/15/19
PCG T-5	8/15/19
PCG T-6	8/15/19
PCG T-7	8/15/19
PCG T-8	8/15/19
PCG T-9	8/15/19
PCG U-1	8/15/19
PCG V-1	8/15/19
PCG V-2	8/15/19
PCG V-3	8/15/19
PCG V-4	8/15/19
PCG W-1	8/15/19
PCG W-2	8/15/19
Index	
I-1	8/15/19
I-2	8/15/19
I-3	8/15/19
I-4	8/15/19
I-5	8/15/19
I-6	8/15/19
I-7	8/15/19
I-8	8/15/19
I-9	8/15/19
I-10	8/15/19
I-11	8/15/19
I-12	8/15/19
I-13	8/15/19
Back Cover	N/A

Subscription Information

*This and other selected Air Traffic publications are available online:
www.faa.gov/air_traffic/publications*

To Obtain Copies of this Publication	
<i>General Public *</i>	<i>Government Organizations*</i>
<p>Write: Superintendent of Documents U.S. Government Printing Office P.O. Box 979050 St. Louis, MO 63197-9000 Phone: 202-512-1800</p> <p>Online: https://bookstore.gpo.gov</p>	<p>This manual will be available on the FAA website by its effective date. All Government organizations are responsible for viewing, downloading, and subscribing to receive electronic mail notifications when changes occur to this manual.</p> <p>Electronic subscription information can be obtained by visiting http://www.faa.gov/air_traffic/publications.</p>
<p><i>*For those desiring printed copies, current pricing is available on the GPO website at http://bookstore.gpo.gov.</i></p>	

Comments/Corrections

The office of primary responsibility (OPR) for this manual is:

FAA Headquarters, Mission Support Services
Air Traffic Procedures (AJV-8)
600 Independence Avenue, SW.
Washington, DC 20597

Proposed changes must be submitted electronically, using the following format, to the Air Traffic Procedures Correspondence Mailbox at 9-AJV-8-HQ-Correspondence@faa.gov.

Notice to Editor

The following comments/corrections are submitted concerning the information contained in:

Paragraph number _____ Title _____
Page _____ Dated _____

Name _____
Street _____
City _____ State _____ Zip _____

Comments/Corrections

The office of primary responsibility (OPR) for this manual is:

FAA Headquarters, Mission Support Services
Air Traffic Procedures (AJV-8)
600 Independence Avenue, SW.
Washington, DC 20597

Proposed changes must be submitted electronically, using the following format, to the Air Traffic Procedures Correspondence Mailbox at 9-AJV-8-HQ-Correspondence@faa.gov.

Notice to Editor

The following comments/corrections are submitted concerning the information contained in:

Paragraph number _____ Title _____
Page _____ Dated _____

Name _____
Street _____
City _____ State _____ Zip _____

Federal Aviation Administration (FAA)

The Federal Aviation Administration is responsible for ensuring the safe, efficient, and secure use of the Nation's airspace, by military as well as civil aviation, for promoting safety in air commerce, for encouraging and developing civil aeronautics, including new aviation technology, and for supporting the requirements of national defense.

The activities required to carry out these responsibilities include: safety regulations; airspace management

and the establishment, operation, and maintenance of a civil–military common system of air traffic control (ATC) and navigation facilities; research and development in support of the fostering of a national system of airports, promulgation of standards and specifications for civil airports, and administration of Federal grants–in–aid for developing public airports; various joint and cooperative activities with the Department of Defense; and technical assistance (under State Department auspices) to other countries.

Aeronautical Information Manual (AIM) Basic Flight Information and ATC Procedures

This manual is designed to provide the aviation community with basic flight information and ATC procedures for use in the National Airspace System (NAS) of the United States. An international version called the Aeronautical Information Publication contains parallel information, as well as specific information on the international airports for use by the international community.

This manual contains the fundamentals required in order to fly in the United States NAS. It also contains items of interest to pilots concerning health and medical facts, factors affecting flight safety, a pilot/controller glossary of terms used in the ATC System, and information on safety, accident, and hazard reporting.

This manual is complemented by other operational publications which are available via separate subscriptions. These publications are:

Notices to Airmen publication - A publication containing data essential to the safety of flight as well as supplemental data affecting the other operational

publications listed here. Issued every four weeks, this publication is available in PDF and HTML format via the Air Traffic Publication website at: https://www.faa.gov/air_traffic/publications/ and through subscription from the General Publishing Office (GPO).

The Chart Supplement U.S., the Chart Supplement Alaska, and the Chart Supplement Pacific – These publications contain information on airports, communications, navigation aids, instrument landing systems, VOR receiver check points, preferred routes, Flight Service Station/Weather Service telephone numbers, Air Route Traffic Control Center (ARTCC) frequencies, part–time surface areas, and various other pertinent special notices essential to air navigation. These publications are available through a network of FAA approved print providers. A listing of products, dates of latest editions, and print providers is available on the Aeronautical Information Services (AIS) website at: http://www.faa.gov/air_traffic/flight_info/aeronav/print_providers/.

Publication Schedule

Basic or Change	Cutoff Date for Completion	Effective Date of Publication
Basic Manual	2/28/19	8/15/19
Change 1	8/15/19	1/30/20
Change 2	1/30/20	7/16/20
Change 3	7/16/20	12/31/20
Basic Manual	12/31/20	6/17/21

Flight Information Publication Policy

The following is in essence, the statement issued by the FAA Administrator and published in the December 10, 1964, issue of the Federal Register, concerning the FAA policy as pertaining to the type of information that will be published as NOTAMs and in the Aeronautical Information Manual.

a. It is a pilot's inherent responsibility to be alert at all times for and in anticipation of all circumstances, situations, and conditions affecting the safe operation of the aircraft. For example, a pilot should expect to find air traffic at any time or place. At or near both civil and military airports and in the vicinity of known training areas, a pilot should expect concentrated air traffic and realize concentrations of air traffic are not limited to these places.

b. It is the general practice of the agency to advertise by NOTAM or other flight information publications such information it may deem appropriate; information which the agency may from time to time make available to pilots is solely for the purpose of assisting them in executing their regulatory responsibilities. Such information serves the aviation community as a whole and not pilots individually.

c. The fact that the agency under one particular situation or another may or may not furnish information does not serve as a precedent of the agency's responsibility to the aviation community; neither does it give assurance that other information of the same or similar nature will be advertised, nor, does it guarantee that any and all information known to the agency will be advertised.

d. This publication, while not regulatory, provides information which reflects examples of operating techniques and procedures which may be requirements in other federal publications or regulations. It is made available solely to assist pilots in executing their responsibilities required by other publications.

Consistent with the foregoing, it is the policy of the Federal Aviation Administration to furnish information only when, in the opinion of the agency, a unique situation should be advertised and not to furnish routine information such as concentrations of air traffic, either civil or military. The Aeronautical Information Manual will not contain informative items concerning everyday circumstances that pilots should, either by good practices or regulation, expect to encounter or avoid.

Aeronautical Information Manual (AIM) Code of Federal Regulations and Advisory Circulars

Code of Federal Regulations - The FAA publishes the Code of Federal Regulations (CFR) to make readily available to the aviation community the regulatory requirements placed upon them. These regulations are sold as individual parts by the Superintendent of Documents.

The more frequently amended parts are sold on subscription service with subscribers receiving changes automatically as issued. Less active parts are sold on a single-sale basis. Changes to single-sale parts will be sold separately as issued. Information concerning these changes will be furnished by the FAA through its Status of Federal Aviation Regulations, AC 00-44.

Advisory Circulars - The FAA issues Advisory Circulars (AC) to inform the aviation public in a systematic way of nonregulatory material. Unless incorporated into a regulation by reference, the contents of an advisory circular are not binding on the public. Advisory Circulars are issued in a numbered subject system corresponding to the subject areas of the Code of Federal Regulations (CFR) (Title 14, Chapter 1, FAA).

AC 00-2, Advisory Circular Checklist and Status of Other FAA Publications, contains advisory circulars that are for sale as well as those distributed free-of-charge by the FAA.

NOTE-

The above information relating to CFRs and ACs is extracted from AC 00-2. Many of the CFRs and ACs listed in AC 00-2 are cross-referenced in the AIM. These regulatory and nonregulatory references cover a wide range of subjects and are a source of detailed information of value to the aviation community. AC 00-2 is issued annually and can be obtained free-of-charge from:

*U.S. Department of Transportation
Subsequent Distribution Office
Ardmore East Business Center
3341 Q 75th Avenue
Landover, MD 20785
Telephone: 301-322-4961*

AC 00-2 may also be found at: <http://www.faa.gov> under Advisory Circulars.

External References - All references to Advisory Circulars and other FAA publications in the Aeronautical Information Manual include the FAA Advisory Circular or Order identification numbers (when available). However, due to varied publication dates, the basic publication letter is not included.

EXAMPLE-

FAA Order JO 7110.65X, Air Traffic Control, is referenced as FAA Order JO 7110.65.

Table of Contents

Chapter 1. Air Navigation

Section 1. Navigation Aids

Paragraph	Page
1-1-1. General	1-1-1
1-1-2. Nondirectional Radio Beacon (NDB)	1-1-1
1-1-3. VHF Omni-directional Range (VOR)	1-1-1
1-1-4. VOR Receiver Check	1-1-3
1-1-5. Tactical Air Navigation (TACAN)	1-1-4
1-1-6. VHF Omni-directional Range/Tactical Air Navigation (VORTAC)	1-1-4
1-1-7. Distance Measuring Equipment (DME)	1-1-5
1-1-8. Navigational Aid (NAVAID) Service Volumes	1-1-5
1-1-9. Instrument Landing System (ILS)	1-1-8
1-1-10. Simplified Directional Facility (SDF)	1-1-13
1-1-11. NAVAID Identifier Removal During Maintenance	1-1-15
1-1-12. NAVAIDs with Voice	1-1-15
1-1-13. User Reports Requested on NAVAID or Global Navigation Satellite System (GNSS) Performance or Interference	1-1-15
1-1-14. LORAN	1-1-16
1-1-15. Inertial Reference Unit (IRU), Inertial Navigation System (INS), and Attitude Heading Reference System (AHRS)	1-1-16
1-1-16. Doppler Radar	1-1-16
1-1-17. Global Positioning System (GPS)	1-1-16
1-1-18. Wide Area Augmentation System (WAAS)	1-1-29
1-1-19. Ground Based Augmentation System (GBAS) Landing System (GLS)	1-1-34
1-1-20. Precision Approach Systems other than ILS and GLS	1-1-35

Section 2. Performance-Based Navigation (PBN) and Area Navigation (RNAV)

1-2-1. General	1-2-1
1-2-2. Required Navigation Performance (RNP)	1-2-4
1-2-3. Use of Suitable Area Navigation (RNAV) Systems on Conventional Procedures and Routes	1-2-7
1-2-4. Pilots and Air Traffic Controllers Recognizing Interference or Spoofing	1-2-9

Chapter 2. Aeronautical Lighting and Other Airport Visual Aids

Section 1. Airport Lighting Aids

2-1-1. Approach Light Systems (ALS)	2-1-1
2-1-2. Visual Glideslope Indicators	2-1-1
2-1-3. Runway End Identifier Lights (REIL)	2-1-6
2-1-4. Runway Edge Light Systems	2-1-6
2-1-5. In-runway Lighting	2-1-6
2-1-6. Runway Status Light (RWSL) System	2-1-7
2-1-7. Stand-Alone Final Approach Runway Occupancy Signal (FAROS)	2-1-10
2-1-8. Control of Lighting Systems	2-1-11

Paragraph	Page
2-1-9. Pilot Control of Airport Lighting	2-1-11
2-1-10. Airport/Heliport Beacons	2-1-14
2-1-11. Taxiway Lights	2-1-15

Section 2. Air Navigation and Obstruction Lighting

2-2-1. Aeronautical Light Beacons	2-2-1
2-2-2. Code Beacons and Course Lights	2-2-1
2-2-3. Obstruction Lights	2-2-1

Section 3. Airport Marking Aids and Signs

2-3-1. General	2-3-1
2-3-2. Airport Pavement Markings	2-3-1
2-3-3. Runway Markings	2-3-1
2-3-4. Taxiway Markings	2-3-7
2-3-5. Holding Position Markings	2-3-12
2-3-6. Other Markings	2-3-16
2-3-7. Airport Signs	2-3-19
2-3-8. Mandatory Instruction Signs	2-3-20
2-3-9. Location Signs	2-3-23
2-3-10. Direction Signs	2-3-25
2-3-11. Destination Signs	2-3-28
2-3-12. Information Signs	2-3-29
2-3-13. Runway Distance Remaining Signs	2-3-29
2-3-14. Aircraft Arresting Systems	2-3-30
2-3-15. Security Identification Display Area (SIDA)	2-3-31

Chapter 3. Airspace

Section 1. General

3-1-1. General	3-1-1
3-1-2. General Dimensions of Airspace Segments	3-1-1
3-1-3. Hierarchy of Overlapping Airspace Designations	3-1-1
3-1-4. Basic VFR Weather Minimums	3-1-1
3-1-5. VFR Cruising Altitudes and Flight Levels	3-1-2

Section 2. Controlled Airspace

3-2-1. General	3-2-1
3-2-2. Class A Airspace	3-2-2
3-2-3. Class B Airspace	3-2-2
3-2-4. Class C Airspace	3-2-4
3-2-5. Class D Airspace	3-2-8
3-2-6. Class E Airspace	3-2-9

Section 3. Class G Airspace

3-3-1. General	3-3-1
3-3-2. VFR Requirements	3-3-1
3-3-3. IFR Requirements	3-3-1

Section 4. Special Use Airspace

Paragraph	Page
3-4-1. General	3-4-1
3-4-2. Prohibited Areas	3-4-1
3-4-3. Restricted Areas	3-4-1
3-4-4. Warning Areas	3-4-1
3-4-5. Military Operations Areas	3-4-2
3-4-6. Alert Areas	3-4-2
3-4-7. Controlled Firing Areas	3-4-2
3-4-8. National Security Areas	3-4-2
3-4-9. Obtaining Special Use Airspace Status	3-4-2

Section 5. Other Airspace Areas

3-5-1. Airport Advisory/Information Services	3-5-1
3-5-2. Military Training Routes	3-5-1
3-5-3. Temporary Flight Restrictions	3-5-2
3-5-4. Parachute Jump Aircraft Operations	3-5-5
3-5-5. Published VFR Routes	3-5-5
3-5-6. Terminal Radar Service Area (TRSA)	3-5-9
3-5-7. Special Air Traffic Rules (SATR) and Special Flight Rules Area (SFRA)	3-5-9
3-5-8. Weather Reconnaissance Area (WRA)	3-5-9

Chapter 4. Air Traffic Control

Section 1. Services Available to Pilots

4-1-1. Air Route Traffic Control Centers	4-1-1
4-1-2. Control Towers	4-1-1
4-1-3. Flight Service Stations	4-1-1
4-1-4. Recording and Monitoring	4-1-1
4-1-5. Communications Release of IFR Aircraft Landing at an Airport Without an Operating Control Tower	4-1-1
4-1-6. Pilot Visits to Air Traffic Facilities	4-1-1
4-1-7. Operation Rain Check	4-1-1
4-1-8. Approach Control Service for VFR Arriving Aircraft	4-1-2
4-1-9. Traffic Advisory Practices at Airports Without Operating Control Towers	4-1-2
4-1-10. IFR Approaches/Ground Vehicle Operations	4-1-6
4-1-11. Designated UNICOM/MULTICOM Frequencies	4-1-6
4-1-12. Use of UNICOM for ATC Purposes	4-1-7
4-1-13. Automatic Terminal Information Service (ATIS)	4-1-7
4-1-14. Automatic Flight Information Service (AFIS) – Alaska FSSs Only	4-1-8
4-1-15. Radar Traffic Information Service	4-1-9
4-1-16. Safety Alert	4-1-10
4-1-17. Radar Assistance to VFR Aircraft	4-1-11
4-1-18. Terminal Radar Services for VFR Aircraft	4-1-12
4-1-19. Tower En Route Control (TEC)	4-1-14
4-1-20. Transponder Operation	4-1-15
4-1-21. Airport Reservation Operations and Special Traffic Management Programs	4-1-18
4-1-22. Requests for Waivers and Authorizations from Title 14, Code of Federal Regulations (14 CFR)	4-1-18
4-1-23. Weather System Processor	4-1-19

Section 2. Radio Communications Phraseology and Techniques

Paragraph	Page
4-2-1. General	4-2-1
4-2-2. Radio Technique	4-2-1
4-2-3. Contact Procedures	4-2-1
4-2-4. Aircraft Call Signs	4-2-3
4-2-5. Description of Interchange or Leased Aircraft	4-2-4
4-2-6. Ground Station Call Signs	4-2-4
4-2-7. Phonetic Alphabet	4-2-5
4-2-8. Figures	4-2-6
4-2-9. Altitudes and Flight Levels	4-2-6
4-2-10. Directions	4-2-6
4-2-11. Speeds	4-2-6
4-2-12. Time	4-2-6
4-2-13. Communications with Tower when Aircraft Transmitter or Receiver or Both are Inoperative	4-2-7
4-2-14. Communications for VFR Flights	4-2-8

Section 3. Airport Operations

4-3-1. General	4-3-1
4-3-2. Airports with an Operating Control Tower	4-3-1
4-3-3. Traffic Patterns	4-3-2
4-3-4. Visual Indicators at Airports Without an Operating Control Tower	4-3-7
4-3-5. Unexpected Maneuvers in the Airport Traffic Pattern	4-3-7
4-3-6. Use of Runways/Declared Distances	4-3-8
4-3-7. Low Level Wind Shear/Microburst Detection Systems	4-3-13
4-3-8. Braking Action Reports and Advisories	4-3-13
4-3-9. Runway Condition Reports	4-3-14
4-3-10. Intersection Takeoffs	4-3-16
4-3-11. Pilot Responsibilities When Conducting Land and Hold Short Operations (LAHSO)	4-3-16
4-3-12. Low Approach	4-3-19
4-3-13. Traffic Control Light Signals	4-3-19
4-3-14. Communications	4-3-20
4-3-15. Gate Holding Due to Departure Delays	4-3-21
4-3-16. VFR Flights in Terminal Areas	4-3-21
4-3-17. VFR Helicopter Operations at Controlled Airports	4-3-21
4-3-18. Taxiing	4-3-23
4-3-19. Taxi During Low Visibility	4-3-24
4-3-20. Exiting the Runway After Landing	4-3-25
4-3-21. Practice Instrument Approaches	4-3-25
4-3-22. Option Approach	4-3-26
4-3-23. Use of Aircraft Lights	4-3-27
4-3-24. Flight Inspection/'Flight Check' Aircraft in Terminal Areas	4-3-28
4-3-25. Hand Signals	4-3-28
4-3-26. Operations at Uncontrolled Airports With Automated Surface Observing System (ASOS)/Automated Weather Observing System (AWOS)	4-3-32

Section 4. ATC Clearances and Aircraft Separation

Paragraph	Page
4-4-1. Clearance	4-4-1
4-4-2. Clearance Prefix	4-4-1
4-4-3. Clearance Items	4-4-1
4-4-4. Amended Clearances	4-4-2
4-4-5. Coded Departure Route (CDR)	4-4-3
4-4-6. Special VFR Clearances	4-4-3
4-4-7. Pilot Responsibility upon Clearance Issuance	4-4-4
4-4-8. IFR Clearance VFR-on-top	4-4-4
4-4-9. VFR/IFR Flights	4-4-5
4-4-10. Adherence to Clearance	4-4-5
4-4-11. IFR Separation Standards	4-4-7
4-4-12. Speed Adjustments	4-4-7
4-4-13. Runway Separation	4-4-10
4-4-14. Visual Separation	4-4-10
4-4-15. Use of Visual Clearing Procedures	4-4-11
4-4-16. Traffic Alert and Collision Avoidance System (TCAS I & II)	4-4-11
4-4-17. Traffic Information Service (TIS)	4-4-12

Section 5. Surveillance Systems

4-5-1. Radar	4-5-1
4-5-2. Air Traffic Control Radar Beacon System (ATCRBS)	4-5-2
4-5-3. Surveillance Radar	4-5-7
4-5-4. Precision Approach Radar (PAR)	4-5-7
4-5-5. Airport Surface Detection Equipment (ASDE-X)/Airport Surface Surveillance Capability (ASSC)	4-5-7
4-5-6. Traffic Information Service (TIS)	4-5-8
4-5-7. Automatic Dependent Surveillance-Broadcast (ADS-B) Services	4-5-14
4-5-8. Traffic Information Service- Broadcast (TIS-B)	4-5-18
4-5-9. Flight Information Service- Broadcast (FIS-B)	4-5-19
4-5-10. Automatic Dependent Surveillance-Rebroadcast (ADS-R)	4-5-21

Section 6. Operational Policy/Procedures for Reduced Vertical Separation Minimum (RVSM) in the Domestic U.S., Alaska, Offshore Airspace and the San Juan FIR

4-6-1. Applicability and RVSM Mandate (Date/Time and Area)	4-6-1
4-6-2. Flight Level Orientation Scheme	4-6-1
4-6-3. Aircraft and Operator Approval Policy/Procedures, RVSM Monitoring and Databases for Aircraft and Operator Approval	4-6-2
4-6-4. Flight Planning into RVSM Airspace	4-6-2
4-6-5. Pilot RVSM Operating Practices and Procedures	4-6-3
4-6-6. Guidance on Severe Turbulence and Mountain Wave Activity (MWA)	4-6-3
4-6-7. Guidance on Wake Turbulence	4-6-5
4-6-8. Pilot/Controller Phraseology	4-6-5
4-6-9. Contingency Actions: Weather Encounters and Aircraft System Failures that Occur After Entry into RVSM Airspace	4-6-7
4-6-10. Procedures for Accommodation of Non-RVSM Aircraft	4-6-9
4-6-11. Non-RVSM Aircraft Requesting Climb to and Descent from Flight Levels Above RVSM Airspace Without Intermediate Level Off	4-6-10

Section 7. Operational Policy/Procedures for the Gulf of Mexico 50 NM Lateral Separation Initiative

Paragraph	Page
4-7-1. Introduction and General Policies	4-7-1
4-7-2. Accommodating Non-RNP 10 Aircraft	4-7-1
4-7-3. Obtaining RNP 10 or RNP 4 Operational Authorization	4-7-1
4-7-4. Authority for Operations with a Single Long-Range Navigation System	4-7-2
4-7-5. Flight Plan Requirements	4-7-2
4-7-6. Contingency Procedures	4-7-2

Chapter 5. Air Traffic Procedures

Section 1. Preflight

5-1-1. Preflight Preparation	5-1-1
5-1-2. Follow IFR Procedures Even When Operating VFR	5-1-2
5-1-3. Notice to Airmen (NOTAM) System	5-1-2
5-1-4. Flight Plan – VFR Flights	5-1-7
5-1-5. Operational Information System (OIS)	5-1-10
5-1-6. Flight Plan– Defense VFR (DVFR) Flights	5-1-10
5-1-7. Composite Flight Plan (VFR/IFR Flights)	5-1-11
5-1-8. Flight Plan (FAA Form 7233-1)– Domestic IFR Flights	5-1-11
5-1-9. International Flight Plan (FAA Form 7233-4)– IFR Flights (For Domestic or International Flights)	5-1-17
5-1-10. IFR Operations to High Altitude Destinations	5-1-27
5-1-11. Flights Outside U.S. Territorial Airspace	5-1-28
5-1-12. Change in Flight Plan	5-1-29
5-1-13. Change in Proposed Departure Time	5-1-29
5-1-14. Closing VFR/DVFR Flight Plans	5-1-29
5-1-15. Canceling IFR Flight Plan	5-1-29
5-1-16. RNAV and RNP Operations	5-1-30
5-1-17. Cold Temperature Operations	5-1-31

Section 2. Departure Procedures

5-2-1. Pre-taxi Clearance Procedures	5-2-1
5-2-2. Automated Pre-Departure Clearance Procedures	5-2-1
5-2-3. IFR Clearances Off Uncontrolled Airports	5-2-2
5-2-4. Taxi Clearance	5-2-2
5-2-5. Line Up and Wait (LUAW)	5-2-2
5-2-6. Abbreviated IFR Departure Clearance (Cleared. .as Filed) Procedures	5-2-3
5-2-7. Departure Restrictions, Clearance Void Times, Hold for Release, and Release Times	5-2-4
5-2-8. Departure Control	5-2-5
5-2-9. Instrument Departure Procedures (DP) – Obstacle Departure Procedures (ODP), Standard Instrument Departures (SID), and Diverse Vector Areas (DVA) ...	5-2-6

Section 3. En Route Procedures

5-3-1. ARTCC Communications	5-3-1
5-3-2. Position Reporting	5-3-13
5-3-3. Additional Reports	5-3-14
5-3-4. Airways and Route Systems	5-3-15

Paragraph	Page
5-3-5. Airway or Route Course Changes	5-3-17
5-3-6. Changeover Points (COPs)	5-3-18
5-3-7. Minimum Turning Altitude (MTA)	5-3-18
5-3-8. Holding	5-3-19

Section 4. Arrival Procedures

5-4-1. Standard Terminal Arrival (STAR) Procedures	5-4-1
5-4-2. Local Flow Traffic Management Program	5-4-3
5-4-3. Approach Control	5-4-3
5-4-4. Advance Information on Instrument Approach	5-4-4
5-4-5. Instrument Approach Procedure (IAP) Charts	5-4-5
5-4-6. Approach Clearance	5-4-26
5-4-7. Instrument Approach Procedures	5-4-27
5-4-8. Special Instrument Approach Procedures	5-4-29
5-4-9. Procedure Turn and Hold-in-lieu of Procedure Turn	5-4-29
5-4-10. Timed Approaches from a Holding Fix	5-4-33
5-4-11. Radar Approaches	5-4-35
5-4-12. Radar Monitoring of Instrument Approaches	5-4-36
5-4-13. Simultaneous Approaches to Parallel Runways	5-4-37
5-4-14. Simultaneous Dependent Approaches	5-4-39
5-4-15. Simultaneous Independent ILS/RNAV/GLS Approaches	5-4-41
5-4-16. Simultaneous Close Parallel PRM Approaches and Simultaneous Offset Instrument Approaches (SOIA)	5-4-43
5-4-17. Simultaneous Converging Instrument Approaches	5-4-50
5-4-18. RNP AR Instrument Approach Procedures	5-4-50
5-4-19. Side-step Maneuver	5-4-52
5-4-20. Approach and Landing Minimums	5-4-52
5-4-21. Missed Approach	5-4-56
5-4-22. Use of Enhanced Flight Vision Systems (EFVS) on Instrument Approaches ..	5-4-58
5-4-23. Visual Approach	5-4-61
5-4-24. Charted Visual Flight Procedure (CVFP)	5-4-62
5-4-25. Contact Approach	5-4-62
5-4-26. Landing Priority	5-4-63
5-4-27. Overhead Approach Maneuver	5-4-63

Section 5. Pilot/Controller Roles and Responsibilities

5-5-1. General	5-5-1
5-5-2. Air Traffic Clearance	5-5-1
5-5-3. Contact Approach	5-5-2
5-5-4. Instrument Approach	5-5-2
5-5-5. Missed Approach	5-5-3
5-5-6. Radar Vectors	5-5-3
5-5-7. Safety Alert	5-5-3
5-5-8. See and Avoid	5-5-4
5-5-9. Speed Adjustments	5-5-4
5-5-10. Traffic Advisories (Traffic Information)	5-5-5
5-5-11. Visual Approach	5-5-5
5-5-12. Visual Separation	5-5-6
5-5-13. VFR-on-top	5-5-6
5-5-14. Instrument Departures	5-5-7

Paragraph	Page
5-5-15. Minimum Fuel Advisory	5-5-7
5-5-16. RNAV and RNP Operations	5-5-7

Section 6. National Security and Interception Procedures

5-6-1. National Security	5-6-1
5-6-2. National Security Requirements	5-6-1
5-6-3. Definitions	5-6-1
5-6-4. ADIZ Requirements	5-6-2
5-6-5. Civil Aircraft Operations To or From U.S. Territorial Airspace	5-6-3
5-6-6. Civil Aircraft Operations Within U.S. Territorial Airspace	5-6-4
5-6-7. Civil Aircraft Operations Transiting U.S. Territorial Airspace	5-6-5
5-6-8. Foreign State Aircraft Operations	5-6-6
5-6-9. FAA/TSA Airspace Waivers	5-6-7
5-6-10. TSA Aviation Security Programs	5-6-7
5-6-11. FAA Flight Routing Authorizations	5-6-7
5-6-12. Emergency Security Control of Air Traffic (ESCAT)	5-6-7
5-6-13. Interception Procedures	5-6-8
5-6-14. Law Enforcement Operations by Civil and Military Organizations	5-6-10
5-6-15. Interception Signals	5-6-11
5-6-16. ADIZ Boundaries and Designated Mountainous Areas	5-6-13
5-6-17. Visual Warning System (VWS)	5-6-14

Chapter 6. Emergency Procedures

Section 1. General

6-1-1. Pilot Responsibility and Authority	6-1-1
6-1-2. Emergency Condition- Request Assistance Immediately	6-1-1

Section 2. Emergency Services Available to Pilots

6-2-1. Radar Service for VFR Aircraft in Difficulty	6-2-1
6-2-2. Transponder Emergency Operation	6-2-1
6-2-3. Intercept and Escort	6-2-1
6-2-4. Emergency Locator Transmitter (ELT)	6-2-2
6-2-5. FAA K-9 Explosives Detection Team Program	6-2-3
6-2-6. Search and Rescue	6-2-4

Section 3. Distress and Urgency Procedures

6-3-1. Distress and Urgency Communications	6-3-1
6-3-2. Obtaining Emergency Assistance	6-3-1
6-3-3. Ditching Procedures	6-3-3
6-3-4. Special Emergency (Air Piracy)	6-3-6
6-3-5. Fuel Dumping	6-3-7

Section 4. Two-way Radio Communications Failure

6-4-1. Two-way Radio Communications Failure	6-4-1
6-4-2. Transponder Operation During Two-way Communications Failure	6-4-2
6-4-3. Reestablishing Radio Contact	6-4-2

Section 5. Aircraft Rescue and Fire Fighting Communications

Paragraph	Page
6-5-1. Discrete Emergency Frequency	6-5-1
6-5-2. Radio Call Signs	6-5-1
6-5-3. ARFF Emergency Hand Signals	6-5-1

Chapter 7. Safety of Flight

Section 1. Meteorology

7-1-1. National Weather Service Aviation Weather Service Program	7-1-1
7-1-2. FAA Weather Services	7-1-2
7-1-3. Use of Aviation Weather Products	7-1-2
7-1-4. Graphical Forecasts for Aviation (GFA)	7-1-5
7-1-5. Preflight Briefing	7-1-7
7-1-6. Inflight Aviation Weather Advisories	7-1-9
7-1-7. Categorical Outlooks	7-1-16
7-1-8. Telephone Information Briefing Service (TIBS) (Alaska Only)	7-1-17
7-1-9. Transcribed Weather Broadcast (TWEB) (Alaska Only)	7-1-17
7-1-10. Inflight Weather Broadcasts	7-1-17
7-1-11. Flight Information Services (FIS)	7-1-20
7-1-12. Weather Observing Programs	7-1-24
7-1-13. Weather Radar Services	7-1-32
7-1-14. ATC Inflight Weather Avoidance Assistance	7-1-36
7-1-15. Runway Visual Range (RVR)	7-1-38
7-1-16. Reporting of Cloud Heights	7-1-40
7-1-17. Reporting Prevailing Visibility	7-1-40
7-1-18. Estimating Intensity of Rain and Ice Pellets	7-1-40
7-1-19. Estimating Intensity of Snow or Drizzle (Based on Visibility)	7-1-41
7-1-20. Pilot Weather Reports (PIREPs)	7-1-41
7-1-21. PIREPs Relating to Airframe Icing	7-1-42
7-1-22. Definitions of Inflight Icing Terms	7-1-43
7-1-23. PIREPs Relating to Turbulence	7-1-45
7-1-24. Wind Shear PIREPs	7-1-46
7-1-25. Clear Air Turbulence (CAT) PIREPs	7-1-46
7-1-26. Microbursts	7-1-46
7-1-27. PIREPs Relating to Volcanic Ash Activity	7-1-57
7-1-28. Thunderstorms	7-1-57
7-1-29. Thunderstorm Flying	7-1-58
7-1-30. Key to Aerodrome Forecast (TAF) and Aviation Routine Weather Report (METAR)	7-1-60
7-1-31. International Civil Aviation Organization (ICAO) Weather Formats	7-1-62

Section 2. Altimeter Setting Procedures

7-2-1. General	7-2-1
7-2-2. Procedures	7-2-1
7-2-3. Altimeter Errors	7-2-3
7-2-4. High Barometric Pressure	7-2-4
7-2-5. Low Barometric Pressure	7-2-4

Section 3. Wake Turbulence

Paragraph	Page
7-3-1. General	7-3-1
7-3-2. Vortex Generation	7-3-1
7-3-3. Vortex Strength	7-3-1
7-3-4. Vortex Behavior	7-3-2
7-3-5. Operations Problem Areas	7-3-4
7-3-6. Vortex Avoidance Procedures	7-3-5
7-3-7. Helicopters	7-3-6
7-3-8. Pilot Responsibility	7-3-6
7-3-9. Air Traffic Wake Turbulence Separations	7-3-7
7-3-10. Development and New Capabilities	7-3-8

Section 4. Bird Hazards and Flight Over National Refuges, Parks, and Forests

7-4-1. Migratory Bird Activity	7-4-1
7-4-2. Reducing Bird Strike Risks	7-4-1
7-4-3. Reporting Bird Strikes	7-4-1
7-4-4. Reporting Bird and Other Wildlife Activities	7-4-1
7-4-5. Pilot Advisories on Bird and Other Wildlife Hazards	7-4-2
7-4-6. Flights Over Charted U.S. Wildlife Refuges, Parks, and Forest Service Areas .	7-4-2

Section 5. Potential Flight Hazards

7-5-1. Accident Cause Factors	7-5-1
7-5-2. VFR in Congested Areas	7-5-1
7-5-3. Obstructions To Flight	7-5-1
7-5-4. Avoid Flight Beneath Unmanned Balloons	7-5-2
7-5-5. Unmanned Aircraft Systems	7-5-2
7-5-6. Mountain Flying	7-5-3
7-5-7. Use of Runway Half-way Signs at Unimproved Airports	7-5-5
7-5-8. Seaplane Safety	7-5-6
7-5-9. Flight Operations in Volcanic Ash	7-5-7
7-5-10. Emergency Airborne Inspection of Other Aircraft	7-5-8
7-5-11. Precipitation Static	7-5-9
7-5-12. Light Amplification by Stimulated Emission of Radiation (Laser) Operations and Reporting Illumination of Aircraft	7-5-10
7-5-13. Flying in Flat Light, Brown Out Conditions, and White Out Conditions	7-5-11
7-5-14. Operations in Ground Icing Conditions	7-5-13
7-5-15. Avoid Flight in the Vicinity of Exhaust Plumes (Smoke Stacks and Cooling Towers)	7-5-14

Section 6. Safety, Accident, and Hazard Reports

7-6-1. Aviation Safety Reporting Program	7-6-1
7-6-2. Aircraft Accident and Incident Reporting	7-6-1
7-6-3. Near Midair Collision Reporting	7-6-2
7-6-4. Unidentified Flying Object (UFO) Reports	7-6-3
7-6-5. Safety Alerts For Operators (SAFO) and Information For Operators (InFO) .	7-6-3

Chapter 8. Medical Facts for Pilots

Section 1. Fitness for Flight

Paragraph	Page
8-1-1. Fitness For Flight	8-1-1
8-1-2. Effects of Altitude	8-1-3
8-1-3. Hyperventilation in Flight	8-1-5
8-1-4. Carbon Monoxide Poisoning in Flight	8-1-5
8-1-5. Illusions in Flight	8-1-5
8-1-6. Vision in Flight	8-1-6
8-1-7. Aerobatic Flight	8-1-8
8-1-8. Judgment Aspects of Collision Avoidance	8-1-8

Chapter 9. Aeronautical Charts and Related Publications

Section 1. Types of Charts Available

9-1-1. General	9-1-1
9-1-2. Obtaining Aeronautical Charts	9-1-1
9-1-3. Selected Charts and Products Available	9-1-1
9-1-4. General Description of Each Chart Series	9-1-1
9-1-5. Where and How to Get Charts of Foreign Areas	9-1-13

Chapter 10. Helicopter Operations

Section 1. Helicopter IFR Operations

10-1-1. Helicopter Flight Control Systems	10-1-1
10-1-2. Helicopter Instrument Approaches	10-1-3
10-1-3. Helicopter Approach Procedures to VFR Heliports	10-1-5
10-1-4. The Gulf of Mexico Grid System	10-1-6

Section 2. Special Operations

10-2-1. Offshore Helicopter Operations	10-2-1
10-2-2. Helicopter Night VFR Operations	10-2-7
10-2-3. Landing Zone Safety	10-2-10
10-2-4. Emergency Medical Service (EMS) Multiple Helicopter Operations	10-2-16

Appendices

Appendix 1. Bird/Other Wildlife Strike Report	Appendix 1-1
Appendix 2. Volcanic Activity Reporting Form (VAR)	Appendix 2-1
Appendix 3. Abbreviations/Acronyms	Appendix 3-1
PILOT/CONTROLLER GLOSSARY	PCG-1
INDEX	I-1

Chapter 1. Air Navigation

Section 1. Navigation Aids

1-1-1. General

a. Various types of air navigation aids are in use today, each serving a special purpose. These aids have varied owners and operators, namely: the Federal Aviation Administration (FAA), the military services, private organizations, individual states and foreign governments. The FAA has the statutory authority to establish, operate, maintain air navigation facilities and to prescribe standards for the operation of any of these aids which are used for instrument flight in federally controlled airspace. These aids are tabulated in the Chart Supplement U.S.

b. Pilots should be aware of the possibility of momentary erroneous indications on cockpit displays when the primary signal generator for a ground-based navigational transmitter (for example, a glideslope, VOR, or nondirectional beacon) is inoperative. Pilots should disregard any navigation indication, regardless of its apparent validity, if the particular transmitter was identified by NOTAM or otherwise as unusable or inoperative.

1-1-2. Nondirectional Radio Beacon (NDB)

a. A low or medium frequency radio beacon transmits nondirectional signals whereby the pilot of an aircraft properly equipped can determine bearings and “home” on the station. These facilities normally operate in a frequency band of 190 to 535 kilohertz (kHz), according to ICAO Annex 10 the frequency range for NDBs is between 190 and 1750 kHz, and transmit a continuous carrier with either 400 or 1020 hertz (Hz) modulation. All radio beacons except the compass locators transmit a continuous three-letter identification in code except during voice transmissions.

b. When a radio beacon is used in conjunction with the Instrument Landing System markers, it is called a Compass Locator.

c. Voice transmissions are made on radio beacons unless the letter “W” (without voice) is included in the class designator (HW).

d. Radio beacons are subject to disturbances that may result in erroneous bearing information. Such disturbances result from such factors as lightning, precipitation static, etc. At night, radio beacons are vulnerable to interference from distant stations. Nearly all disturbances which affect the Automatic Direction Finder (ADF) bearing also affect the facility’s identification. Noisy identification usually occurs when the ADF needle is erratic. Voice, music or erroneous identification may be heard when a steady false bearing is being displayed. Since ADF receivers do not have a “flag” to warn the pilot when erroneous bearing information is being displayed, the pilot should continuously monitor the NDB’s identification.

1-1-3. VHF Omni-directional Range (VOR)

a. VORs operate within the 108.0 to 117.95 MHz frequency band and have a power output necessary to provide coverage within their assigned operational service volume. They are subject to line-of-sight restrictions, and the range varies proportionally to the altitude of the receiving equipment.

NOTE-

Normal service ranges for the various classes of VORs are given in Navigational Aid (NAVAID) Service Volumes, Paragraph 1-1-8.

b. Most VORs are equipped for voice transmission on the VOR frequency. VORs without voice capability are indicated by the letter “W” (without voice) included in the class designator (VORW).

c. The only positive method of identifying a VOR is by its Morse Code identification or by the recorded automatic voice identification which is always indicated by use of the word “VOR” following the range’s name. Reliance on determining the identification of an omnirange should never be placed on listening to voice transmissions by the Flight Service Station (FSS) (or approach control facility) involved. Many FSSs remotely operate several omniranges with different names. In some cases, none of the VORs have the name of the “parent” FSS. During periods of maintenance, the facility may radiate a T-E-S-T code (— ● ●● —) or the code may be

removed. Some VOR equipment decodes the identifier and displays it to the pilot for verification to charts, while other equipment simply displays the expected identifier from a database to aid in verification to the audio tones. You should be familiar with your equipment and use it appropriately. If your equipment automatically decodes the identifier, it is not necessary to listen to the audio identification.

d. Voice identification has been added to numerous VORs. The transmission consists of a voice announcement, “AIRVILLE VOR” alternating with the usual Morse Code identification.

e. The effectiveness of the VOR depends upon proper use and adjustment of both ground and airborne equipment.

1. Accuracy. The accuracy of course alignment of the VOR is excellent, being generally plus or minus 1 degree.

2. Roughness. On some VORs, minor course roughness may be observed, evidenced by course needle or brief flag alarm activity (some receivers are more susceptible to these irregularities than others). At a few stations, usually in mountainous terrain, the pilot may occasionally observe a brief course needle oscillation, similar to the indication of “approaching station.” Pilots flying over unfamiliar routes are cautioned to be on the alert for these vagaries, and in particular, to use the “to/from” indicator to determine positive station passage.

(a) Certain propeller revolutions per minute (RPM) settings or helicopter rotor speeds can cause the VOR Course Deviation Indicator to fluctuate as much as plus or minus six degrees. Slight changes to the RPM setting will normally smooth out this roughness. Pilots are urged to check for this modulation phenomenon prior to reporting a VOR station or aircraft equipment for unsatisfactory operation.

f. The VOR Minimum Operational Network (MON). As flight procedures and route structure based on VORs are gradually being replaced with Performance-Based Navigation (PBN) procedures, the FAA is removing selected VORs from service. PBN procedures are primarily enabled by GPS and its augmentation systems, collectively referred to as Global Navigation Satellite System (GNSS). Aircraft that carry DME/DME equipment can also use RNAV which provides a backup to continue flying PBN

during a GNSS disruption. For those aircraft that do not carry DME/DME, the FAA is retaining a limited network of VORs, called the VOR MON, to provide a basic conventional navigation service for operators to use if GNSS becomes unavailable. During a GNSS disruption, the MON will enable aircraft to navigate through the affected area or to a safe landing at a MON airport without reliance on GNSS. Navigation using the MON will not be as efficient as the new PBN route structure, but use of the MON will provide nearly continuous VOR signal coverage at 5,000 feet AGL across the NAS, outside of the Western U.S. Mountainous Area (WUSMA).

NOTE–

There is no plan to change the NAVAID and route structure in the WUSMA.

The VOR MON has been retained principally for IFR aircraft that are not equipped with DME/DME avionics. However, VFR aircraft may use the MON as desired. Aircraft equipped with DME/DME navigation systems would, in most cases, use DME/DME to continue flight using RNAV to their destination. However, these aircraft may, of course, use the MON.

1. Distance to a MON airport. The VOR MON will ensure that regardless of an aircraft’s position in the contiguous United States (CONUS), a MON airport (equipped with legacy ILS or VOR approaches) will be within 100 nautical miles. These airports are referred to as “MON airports” and will have an ILS approach or a VOR approach if an ILS is not available. VORs to support these approaches will be retained in the VOR MON. MON airports are charted on low-altitude en route charts and are contained in the Chart Supplement U.S. and other appropriate publications.

NOTE–

Any suitable airport can be used to land in the event of a VOR outage. For example, an airport with a DME–required ILS approach may be available and could be used by aircraft that are equipped with DME. The intent of the MON airport is to provide an approach that can be used by aircraft without ADF or DME when radar may not be available.

2. Navigating to an airport. The VOR MON will retain sufficient VORs and increase VOR service volume to ensure that pilots will have nearly continuous signal reception of a VOR when flying at 5,000 feet AGL. A key concept of the MON is to ensure that an aircraft will always be within 100 NM

of an airport with an instrument approach that is not dependent on GPS. (See paragraph 1-1-8.) If the pilot encounters a GPS outage, the pilot will be able to proceed via VOR-to-VOR navigation at 5,000 feet AGL through the GPS outage area or to a safe landing at a MON airport or another suitable airport, as appropriate. Nearly all VORs inside of the WUSMA and outside the CONUS are being retained. In these areas, pilots use the existing (Victor and Jet) route structure and VORs to proceed through a GPS outage or to a landing.

3. Using the VOR MON.

(a) In the case of a planned GPS outage (for example, one that is in a published NOTAM), pilots may plan to fly through the outage using the MON as appropriate and as cleared by ATC. Similarly, aircraft not equipped with GPS may plan to fly and land using the MON, as appropriate and as cleared by ATC.

NOTE-

In many cases, flying using the MON may involve a more circuitous route than flying GPS-enabled RNAV.

(b) In the case of an unscheduled GPS outage, pilots and ATC will need to coordinate the best outcome for all aircraft. It is possible that a GPS outage could be disruptive, causing high workload and demand for ATC service. Generally, the VOR MON concept will enable pilots to navigate through the GPS outage or land at a MON airport or at another airport that may have an appropriate approach or may be in visual conditions.

(1) The VOR MON is a reversionary service provided by the FAA for use by aircraft that are unable to continue RNAV during a GPS disruption. The FAA has not mandated that preflight or inflight planning include provisions for GPS- or WAAS-equipped aircraft to carry sufficient fuel to proceed to a MON airport in case of an unforeseen GPS outage. Specifically, flying to a MON airport as a filed alternate will not be explicitly required. Of course, consideration for the possibility of a GPS outage is prudent during flight planning as is maintaining proficiency with VOR navigation.

(2) Also, in case of a GPS outage, pilots may coordinate with ATC and elect to continue through the outage or land. The VOR MON is designed to ensure that an aircraft is within 100 NM of an airport, but pilots may decide to proceed to any appropriate airport where a landing can be made.

WAAS users flying under Part 91 are not required to carry VOR avionics. These users do not have the ability or requirement to use the VOR MON. Prudent flight planning, by these WAAS-only aircraft, should consider the possibility of a GPS outage.

NOTE-

The FAA recognizes that non-GPS-based approaches will be reduced when VORs are eliminated, and that most airports with an instrument approach may only have GPS- or WAAS-based approaches. Pilots flying GPS- or WAAS-equipped aircraft that also have VOR/ILS avionics should be diligent to maintain proficiency in VOR and ILS approaches in the event of a GPS outage.

1-1-4. VOR Receiver Check

a. The FAA VOR test facility (VOT) transmits a test signal which provides users a convenient means to determine the operational status and accuracy of a VOR receiver while on the ground where a VOT is located. The airborne use of VOT is permitted; however, its use is strictly limited to those areas/altitudes specifically authorized in the Chart Supplement U.S. or appropriate supplement.

b. To use the VOT service, tune in the VOT frequency on your VOR receiver. With the Course Deviation Indicator (CDI) centered, the omni-bearing selector should read 0 degrees with the to/from indication showing “from” or the omni-bearing selector should read 180 degrees with the to/from indication showing “to.” Should the VOR receiver operate an RMI (Radio Magnetic Indicator), it will indicate 180 degrees on any omni-bearing selector (OBS) setting. Two means of identification are used. One is a series of dots and the other is a continuous tone. Information concerning an individual test signal can be obtained from the local FSS.

c. Periodic VOR receiver calibration is most important. If a receiver’s Automatic Gain Control or modulation circuit deteriorates, it is possible for it to display acceptable accuracy and sensitivity close into the VOR or VOT and display out-of-tolerance readings when located at greater distances where weaker signal areas exist. The likelihood of this deterioration varies between receivers, and is generally considered a function of time. The best assurance of having an accurate receiver is periodic calibration. Yearly intervals are recommended at which time an authorized repair facility should recalibrate the receiver to the manufacturer’s specifications.

d. Federal Aviation Regulations (14 CFR Section 91.171) provides for certain VOR equipment accuracy checks prior to flight under instrument flight rules. To comply with this requirement and to ensure satisfactory operation of the airborne system, the FAA has provided pilots with the following means of checking VOR receiver accuracy:

1. VOT or a radiated test signal from an appropriately rated radio repair station.
2. Certified airborne check points.
3. Certified check points on the airport surface.

e. A radiated VOT from an appropriately rated radio repair station serves the same purpose as an FAA VOR signal and the check is made in much the same manner as a VOT with the following differences:

1. The frequency normally approved by the Federal Communications Commission is 108.0 MHz.

2. Repair stations are not permitted to radiate the VOR test signal continuously; consequently, the owner or operator must make arrangements with the repair station to have the test signal transmitted. This service is not provided by all radio repair stations. The aircraft owner or operator must determine which repair station in the local area provides this service. A representative of the repair station must make an entry into the aircraft logbook or other permanent record certifying to the radial accuracy and the date of transmission. The owner, operator or representative of the repair station may accomplish the necessary checks in the aircraft and make a logbook entry stating the results. It is necessary to verify which test radial is being transmitted and whether you should get a “to” or “from” indication.

f. Airborne and ground check points consist of certified radials that should be received at specific points on the airport surface or over specific landmarks while airborne in the immediate vicinity of the airport.

1. Should an error in excess of plus or minus 4 degrees be indicated through use of a ground check, or plus or minus 6 degrees using the airborne check, Instrument Flight Rules (IFR) flight must not be attempted without first correcting the source of the error.

CAUTION–

No correction other than the correction card figures supplied by the manufacturer should be applied in making these VOR receiver checks.

2. Locations of airborne check points, ground check points and VOTs are published in the Chart Supplement U.S.

3. If a dual system VOR (units independent of each other except for the antenna) is installed in the aircraft, one system may be checked against the other. Turn both systems to the same VOR ground facility and note the indicated bearing to that station. The maximum permissible variations between the two indicated bearings is 4 degrees.

1–1–5. Tactical Air Navigation (TACAN)

a. For reasons peculiar to military or naval operations (unusual siting conditions, the pitching and rolling of a naval vessel, etc.) the civil VOR/Distance Measuring Equipment (DME) system of air navigation was considered unsuitable for military or naval use. A new navigational system, TACAN, was therefore developed by the military and naval forces to more readily lend itself to military and naval requirements. As a result, the FAA has integrated TACAN facilities with the civil VOR/DME program. Although the theoretical, or technical principles of operation of TACAN equipment are quite different from those of VOR/DME facilities, the end result, as far as the navigating pilot is concerned, is the same. These integrated facilities are called VORTACs.

b. TACAN ground equipment consists of either a fixed or mobile transmitting unit. The airborne unit in conjunction with the ground unit reduces the transmitted signal to a visual presentation of both azimuth and distance information. TACAN is a pulse system and operates in the Ultrahigh Frequency (UHF) band of frequencies. Its use requires TACAN airborne equipment and does not operate through conventional VOR equipment.

1–1–6. VHF Omni-directional Range/Tactical Air Navigation (VORTAC)

a. A VORTAC is a facility consisting of two components, VOR and TACAN, which provides three individual services: VOR azimuth, TACAN azimuth and TACAN distance (DME) at one site. Although consisting of more than one component,

incorporating more than one operating frequency, and using more than one antenna system, a VORTAC is considered to be a unified navigational aid. Both components of a VORTAC are envisioned as operating simultaneously and providing the three services at all times.

b. Transmitted signals of VOR and TACAN are each identified by three-letter code transmission and are interlocked so that pilots using VOR azimuth with TACAN distance can be assured that both signals being received are definitely from the same ground station. The frequency channels of the VOR and the TACAN at each VORTAC facility are “paired” in accordance with a national plan to simplify airborne operation.

1-1-7. Distance Measuring Equipment (DME)

a. In the operation of DME, paired pulses at a specific spacing are sent out from the aircraft (this is the interrogation) and are received at the ground station. The ground station (transponder) then transmits paired pulses back to the aircraft at the same pulse spacing but on a different frequency. The time required for the round trip of this signal exchange is measured in the airborne DME unit and is translated into distance (nautical miles) from the aircraft to the ground station.

b. Operating on the line-of-sight principle, DME furnishes distance information with a very high degree of accuracy. Reliable signals may be received at distances up to 199 NM at line-of-sight altitude with an accuracy of better than $\frac{1}{2}$ mile or 3 percent of the distance, whichever is greater. Distance information received from DME equipment is SLANT RANGE distance and not actual horizontal distance.

c. Operating frequency range of a DME according to ICAO Annex 10 is from 960 MHz to 1215 MHz. Aircraft equipped with TACAN equipment will receive distance information from a VORTAC automatically, while aircraft equipped with VOR must have a separate DME airborne unit.

d. VOR/DME, VORTAC, Instrument Landing System (ILS)/DME, and localizer (LOC)/DME navigation facilities established by the FAA provide course and distance information from collocated components under a frequency pairing plan. Aircraft

receiving equipment which provides for automatic DME selection assures reception of azimuth and distance information from a common source when designated VOR/DME, VORTAC, ILS/DME, and LOC/DME are selected.

e. Due to the limited number of available frequencies, assignment of paired frequencies is required for certain military noncollocated VOR and TACAN facilities which serve the same area but which may be separated by distances up to a few miles.

f. VOR/DME, VORTAC, ILS/DME, and LOC/DME facilities are identified by synchronized identifications which are transmitted on a time share basis. The VOR or localizer portion of the facility is identified by a coded tone modulated at 1020 Hz or a combination of code and voice. The TACAN or DME is identified by a coded tone modulated at 1350 Hz. The DME or TACAN coded identification is transmitted one time for each three or four times that the VOR or localizer coded identification is transmitted. When either the VOR or the DME is inoperative, it is important to recognize which identifier is retained for the operative facility. A single coded identification with a repetition interval of approximately 30 seconds indicates that the DME is operative.

g. Aircraft equipment which provides for automatic DME selection assures reception of azimuth and distance information from a common source when designated VOR/DME, VORTAC and ILS/DME navigation facilities are selected. Pilots are cautioned to disregard any distance displays from automatically selected DME equipment when VOR or ILS facilities, which do not have the DME feature installed, are being used for position determination.

1-1-8. Navigational Aid (NAVAID) Service Volumes

a. Most air navigation radio aids which provide positive course guidance have a designated standard service volume (SSV). The SSV defines the reception limits of unrestricted NAVAIDs which are usable for random/unpublished route navigation.

b. A NAVAID will be classified as restricted if it does not conform to flight inspection signal strength and course quality standards throughout the published SSV. However, the NAVAID should not be considered usable at altitudes below that which could

be flown while operating under random route IFR conditions (14 CFR Section 91.177), even though these altitudes may lie within the designated SSV. Service volume restrictions are first published in Notices to Airmen (NOTAMs) and then with the alphabetical listing of the NAVAIDs in the Chart Supplement U.S.

c. Standard Service Volume limitations do not apply to published IFR routes or procedures.

d. VOR/DME/TACAN Standard Service Volumes (SSV).

1. Standard service volumes (SSVs) are graphically shown in FIG 1-1-1, FIG 1-1-2, FIG 1-1-3, FIG 1-1-4, and FIG 1-1-5. The SSV of a station is indicated by using the class designator as a prefix to the station type designation.

EXAMPLE-
TVOR, LDME, and HVORTAC.

FIG 1-1-1
Standard High Altitude Service Volume
(See FIG 1-1-5 for altitudes below 1,000 feet).

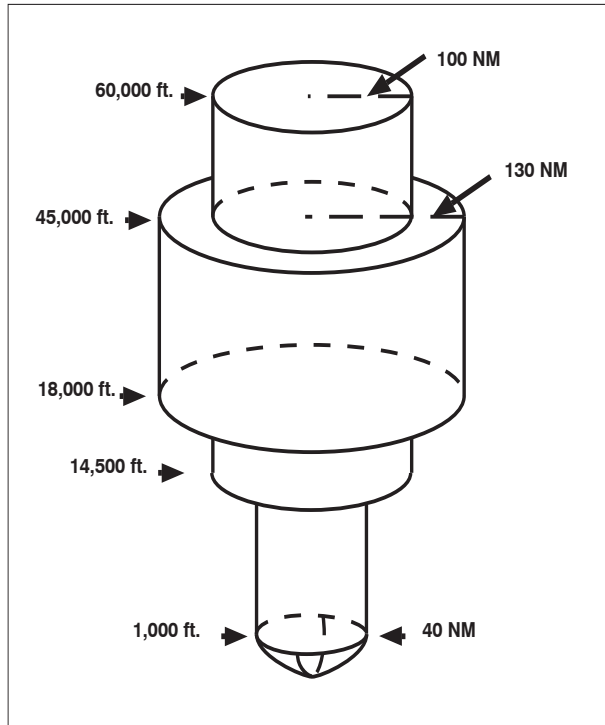
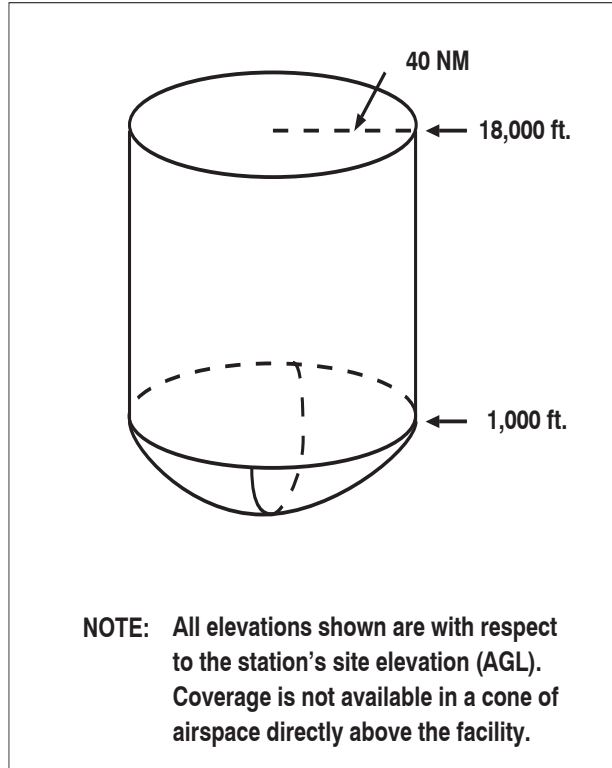

FIG 1-1-2
Standard Low Altitude Service Volume
(See FIG 1-1-5 for altitudes below 1,000 feet).



2. Within 25 NM, the bottom of the T service volume is defined by the curve in FIG 1-1-4. Within 40 NM, the bottoms of the L and H service volumes are defined by the curve in FIG 1-1-5. (See TBL 1-1-1.)

e. Nondirectional Radio Beacon (NDB)

1. NDBs are classified according to their intended use.

2. The ranges of NDB service volumes are shown in TBL 1-1-2. The distances (radius) are the same at all altitudes.

TBL 1-1-1
VOR/DME/TACAN Standard Service Volumes

SSV Class Designator	Altitude and Range Boundaries
T (Terminal)	From 1,000 feet above ground level (AGL) up to and including 12,000 feet AGL at radial distances out to 25 NM.
L (Low Altitude)	From 1,000 feet AGL up to and including 18,000 feet AGL at radial distances out to 40 NM.
H (High Altitude)	From 1,000 feet AGL up to and including 14,500 feet AGL at radial distances out to 40 NM. From 14,500 feet AGL up to and including 60,000 feet at radial distances out to 100 NM. From 18,000 feet AGL up to and including 45,000 feet AGL at radial distances out to 130 NM.

TBL 1-1-2
NDB Service Volumes

Class	Distance (Radius)
Compass Locator	15 NM
MH	25 NM
H	50 NM*
HH	75 NM

**Service ranges of individual facilities may be less than 50 nautical miles (NM). Restrictions to service volumes are first published as a Notice to Airmen and then with the alphabetical listing of the NAVAID in the Chart Supplement U.S.*

FIG 1-1-3
Standard Terminal Service Volume
 (See FIG 1-1-4 for altitudes below 1,000 feet).

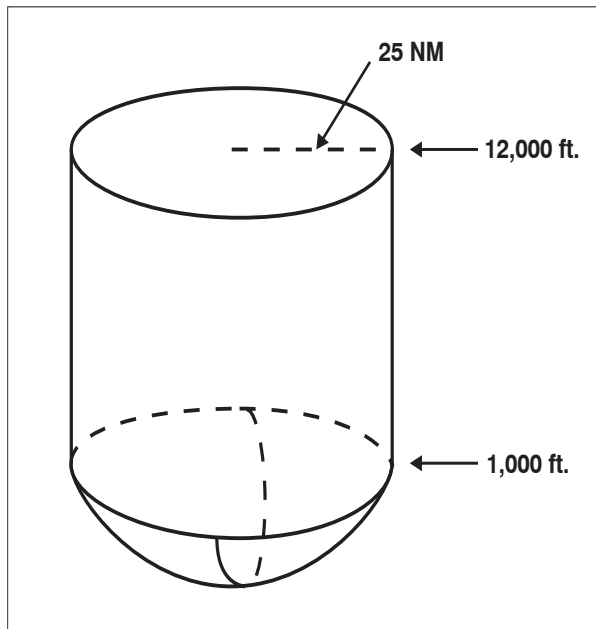

FIG 1-1-4
Service Volume Lower Edge Terminal

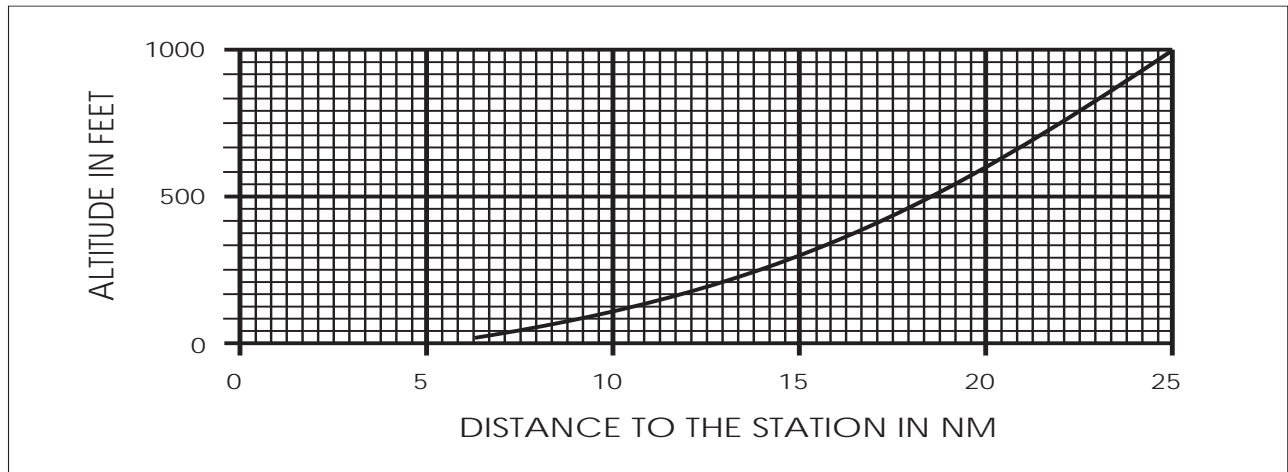
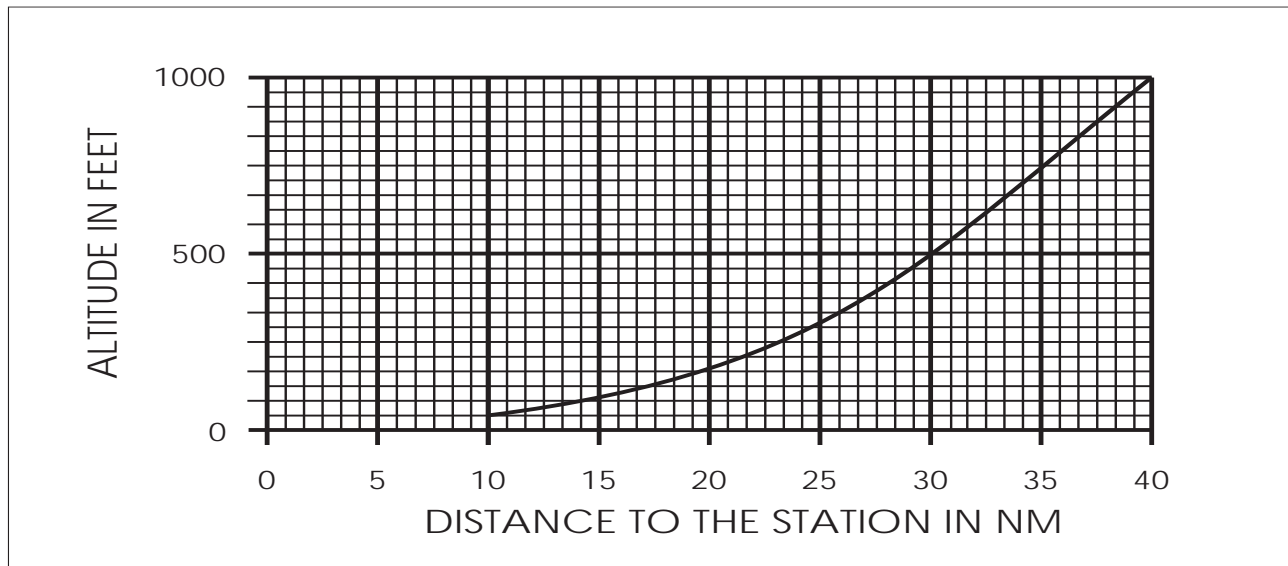

FIG 1-1-5
Service Volume Lower Edge
Standard High and Low



1-1-9. Instrument Landing System (ILS)

a. General

1. The ILS is designed to provide an approach path for exact alignment and descent of an aircraft on final approach to a runway.

2. The ground equipment consists of two highly directional transmitting systems and, along the approach, three (or fewer) marker beacons. The directional transmitters are known as the localizer and glide slope transmitters.

3. The system may be divided functionally into three parts:

(a) **Guidance information:** localizer, glide slope;

(b) **Range information:** marker beacon, DME; and

(c) **Visual information:** approach lights, touchdown and centerline lights, runway lights.

4. Precision radar, or compass locators located at the Outer Marker (OM) or Middle Marker (MM), may be substituted for marker beacons. DME, when

specified in the procedure, may be substituted for the OM.

5. Where a complete ILS system is installed on each end of a runway; (i.e., the approach end of Runway 4 and the approach end of Runway 22) the ILS systems are not in service simultaneously.

b. Localizer

1. The localizer transmitter operates on one of 40 ILS channels within the frequency range of 108.10 to 111.95 MHz. Signals provide the pilot with course guidance to the runway centerline.

2. The approach course of the localizer is called the front course and is used with other functional parts, e.g., glide slope, marker beacons, etc. The localizer signal is transmitted at the far end of the runway. It is adjusted for a course width of (full scale fly-left to a full scale fly-right) of 700 feet at the runway threshold.

3. The course line along the extended centerline of a runway, in the opposite direction to the front course is called the back course.

CAUTION-

Unless the aircraft's ILS equipment includes reverse sensing capability, when flying inbound on the back course it is necessary to steer the aircraft in the direction opposite the needle deflection when making corrections from off-course to on-course. This "flying away from the needle" is also required when flying outbound on the front course of the localizer. Do not use back course signals for approach unless a back course approach procedure is published for that particular runway and the approach is authorized by ATC.

4. Identification is in International Morse Code and consists of a three-letter identifier preceded by the letter I (•••) transmitted on the localizer frequency.

EXAMPLE- I-DIA

5. The localizer provides course guidance throughout the descent path to the runway threshold from a distance of 18 NM from the antenna between an altitude of 1,000 feet above the highest terrain along the course line and 4,500 feet above the elevation of the antenna site. Proper off-course indications are provided throughout the following angular areas of the operational service volume:

(a) To 10 degrees either side of the course along a radius of 18 NM from the antenna; and

(b) From 10 to 35 degrees either side of the course along a radius of 10 NM. (See FIG 1-1-6.)

FIG 1-1-6
Limits of Localizer Coverage

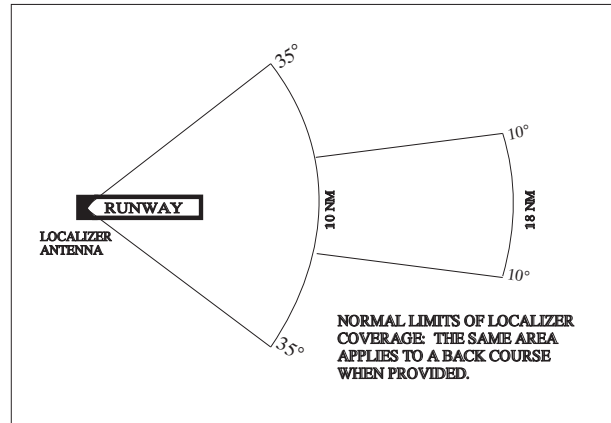

6. Unreliable signals may be received outside these areas.

c. Localizer Type Directional Aid (LDA)

1. The LDA is of comparable use and accuracy to a localizer but is not part of a complete ILS. The LDA course usually provides a more precise approach course than the similar Simplified Directional Facility (SDF) installation, which may have a course width of 6 or 12 degrees.

2. The LDA is not aligned with the runway. Straight-in minimums may be published where alignment does not exceed 30 degrees between the course and runway. Circling minimums only are published where this alignment exceeds 30 degrees.

3. A very limited number of LDA approaches also incorporate a glideslope. These are annotated in the plan view of the instrument approach chart with a note, "LDA/Glideslope." These procedures fall under a newly defined category of approaches called Approach with Vertical Guidance (APV) described in paragraph 5-4-5, Instrument Approach Procedure Charts, subparagraph a7(b), Approach with Vertical Guidance (APV). LDA minima for with and without glideslope is provided and annotated on the minima lines of the approach chart as S-LDA/GS and S-LDA. Because the final approach course is not aligned with the runway centerline, additional maneuvering will be required compared to an ILS approach.

d. Glide Slope/Glide Path

1. The UHF glide slope transmitter, operating on one of the 40 ILS channels within the frequency range 329.15 MHz, to 335.00 MHz radiates its signals in the direction of the localizer front course. The term “glide path” means that portion of the glide slope that intersects the localizer.

CAUTION—

False glide slope signals may exist in the area of the localizer back course approach which can cause the glide slope flag alarm to disappear and present unreliable glide slope information. Disregard all glide slope signal indications when making a localizer back course approach unless a glide slope is specified on the approach and landing chart.

2. The glide slope transmitter is located between 750 feet and 1,250 feet from the approach end of the runway (down the runway) and offset 250 to 650 feet from the runway centerline. It transmits a glide path beam 1.4 degrees wide (vertically). The signal provides descent information for navigation down to the lowest authorized decision height (DH) specified in the approved ILS approach procedure. The glidepath may not be suitable for navigation below the lowest authorized DH and any reference to glidepath indications below that height must be supplemented by visual reference to the runway environment. Glidepaths with no published DH are usable to runway threshold.

3. The glide path projection angle is normally adjusted to 3 degrees above horizontal so that it intersects the MM at about 200 feet and the OM at about 1,400 feet above the runway elevation. The glide slope is normally usable to the distance of 10 NM. However, at some locations, the glide slope has been certified for an extended service volume which exceeds 10 NM.

4. Pilots must be alert when approaching the glidepath interception. False courses and reverse sensing will occur at angles considerably greater than the published path.

5. Make every effort to remain on the indicated glide path.

CAUTION—

Avoid flying below the glide path to assure obstacle/terrain clearance is maintained.

6. The published glide slope threshold crossing height (TCH) DOES NOT represent the height of the

actual glide path on-course indication above the runway threshold. It is used as a reference for planning purposes which represents the height above the runway threshold that an aircraft’s glide slope antenna should be, if that aircraft remains on a trajectory formed by the four-mile-to-middle marker glidepath segment.

7. Pilots must be aware of the vertical height between the aircraft’s glide slope antenna and the main gear in the landing configuration and, at the DH, plan to adjust the descent angle accordingly if the published TCH indicates the wheel crossing height over the runway threshold may not be satisfactory. Tests indicate a comfortable wheel crossing height is approximately 20 to 30 feet, depending on the type of aircraft.

NOTE—

The TCH for a runway is established based on several factors including the largest aircraft category that normally uses the runway, how airport layout affects the glide slope antenna placement, and terrain. A higher than optimum TCH, with the same glide path angle, may cause the aircraft to touch down further from the threshold if the trajectory of the approach is maintained until the flare. Pilots should consider the effect of a high TCH on the runway available for stopping the aircraft.

e. Distance Measuring Equipment (DME)

1. When installed with the ILS and specified in the approach procedure, DME may be used:

- (a) In lieu of the OM;
- (b) As a back course (BC) final approach fix (FAF); and
- (c) To establish other fixes on the localizer course.

2. In some cases, DME from a separate facility may be used within Terminal Instrument Procedures (TERPS) limitations:

- (a) To provide ARC initial approach segments;
- (b) As a FAF for BC approaches; and
- (c) As a substitute for the OM.

f. Marker Beacon

1. ILS marker beacons have a rated power output of 3 watts or less and an antenna array designed to produce an elliptical pattern with dimensions, at 1,000 feet above the antenna, of approximately 2,400 feet in width and 4,200 feet in

length. Airborne marker beacon receivers with a selective sensitivity feature should always be operated in the “low” sensitivity position for proper reception of ILS marker beacons.

2. Ordinarily, there are two marker beacons associated with an ILS, the OM and MM. Locations with a Category II ILS also have an Inner Marker (IM). When an aircraft passes over a marker, the pilot will receive the indications shown in TBL 1-1-3.

(a) The OM normally indicates a position at which an aircraft at the appropriate altitude on the localizer course will intercept the ILS glide path.

(b) The MM indicates a position approximately 3,500 feet from the landing threshold. This is also the position where an aircraft on the glide path will be at an altitude of approximately 200 feet above the elevation of the touchdown zone.

(c) The IM will indicate a point at which an aircraft is at a designated decision height (DH) on the glide path between the MM and landing threshold.

**TBL 1-1-3
Marker Passage Indications**

Marker	Code	Light
OM	- - -	BLUE
MM	• - • -	AMBER
IM	• • • •	WHITE
BC	• • • •	WHITE

3. A back course marker normally indicates the ILS back course final approach fix where approach descent is commenced.

g. Compass Locator

1. Compass locator transmitters are often situated at the MM and OM sites. The transmitters have a power of less than 25 watts, a range of at least 15 miles and operate between 190 and 535 kHz. At some locations, higher powered radio beacons, up to 400 watts, are used as OM compass locators. These generally carry Transcribed Weather Broadcast (TWEB) information.

2. Compass locators transmit two letter identification groups. The outer locator transmits the first two letters of the localizer identification group, and

the middle locator transmits the last two letters of the localizer identification group.

h. ILS Frequency (See TBL 1-1-4.)

**TBL 1-1-4
Frequency Pairs Allocated for ILS**

Localizer MHz	Glide Slope
108.10	334.70
108.15	334.55
108.3	334.10
108.35	333.95
108.5	329.90
108.55	329.75
108.7	330.50
108.75	330.35
108.9	329.30
108.95	329.15
109.1	331.40
109.15	331.25
109.3	332.00
109.35	331.85
109.50	332.60
109.55	332.45
109.70	333.20
109.75	333.05
109.90	333.80
109.95	333.65
110.1	334.40
110.15	334.25
110.3	335.00
110.35	334.85
110.5	329.60
110.55	329.45
Localizer MHz	Glide Slope
110.70	330.20
110.75	330.05
110.90	330.80
110.95	330.65
111.10	331.70
111.15	331.55
111.30	332.30
111.35	332.15
111.50	332.9
111.55	332.75
111.70	333.5
111.75	333.35
111.90	331.1
111.95	330.95

i. ILS Minimums

1. The lowest authorized ILS minimums, with all required ground and airborne systems components operative, are:

(a) **Category I.** Decision Height (DH) 200 feet and Runway Visual Range (RVR) 2,400 feet (with touchdown zone and centerline lighting, RVR 1,800 feet), or (with Autopilot or FD or HUD, RVR 1,800 feet);

(b) **Special Authorization Category I.** DH 150 feet and Runway Visual Range (RVR) 1,400 feet, HUD to DH;

(c) **Category II.** DH 100 feet and RVR 1,200 feet (with autoland or HUD to touchdown and noted on authorization, RVR 1,000 feet);

(d) **Special Authorization Category II with Reduced Lighting.** DH 100 feet and RVR 1,200 feet with autoland or HUD to touchdown and noted on authorization (touchdown zone, centerline lighting, and ALSF-2 are not required);

(e) **Category IIIa.** No DH or DH below 100 feet and RVR not less than 700 feet;

(f) **Category IIIb.** No DH or DH below 50 feet and RVR less than 700 feet but not less than 150 feet; and

(g) **Category IIIc.** No DH and no RVR limitation.

NOTE—

Special authorization and equipment required for Categories II and III.

j. Inoperative ILS Components

1. **Inoperative localizer.** When the localizer fails, an ILS approach is not authorized.

2. **Inoperative glide slope.** When the glide slope fails, the ILS reverts to a non-precision localizer approach.

REFERENCE—

See the inoperative component table in the U.S. Government Terminal Procedures Publication (TPP), for adjustments to minimums due to inoperative airborne or ground system equipment.

k. ILS Course Distortion

1. All pilots should be aware that disturbances to ILS localizer and glide slope courses may occur when surface vehicles or aircraft are operated near the localizer or glide slope antennas. Most ILS

installations are subject to signal interference by either surface vehicles, aircraft or both. ILS CRITICAL AREAS are established near each localizer and glide slope antenna.

2. ATC issues control instructions to avoid interfering operations within ILS critical areas at controlled airports during the hours the Airport Traffic Control Tower (ATCT) is in operation as follows:

(a) **Weather Conditions.** Official weather observation is a ceiling of less than 800 feet and/or visibility 2 miles.

(1) **Localizer Critical Area.** Except for aircraft that land, exit a runway, depart, or execute a missed approach, vehicles and aircraft are not authorized in or over the critical area when an arriving aircraft is inside the outer marker (OM) or the fix used in lieu of the OM. Additionally, whenever the official weather observation is a ceiling of less than 200 feet or RVR less than 2,000 feet, do not authorize vehicles or aircraft operations in or over the area when an arriving aircraft is inside the MM, or in the absence of a MM, ½ mile final.

(2) **Glide Slope Critical Area.** Do not authorize vehicles or aircraft operations in or over the area when an arriving aircraft is inside the ILS outer marker (OM), or the fix used in lieu of the OM, unless the arriving aircraft has reported the runway in sight and is circling or side-stepping to land on another runway.

(b) **Weather Conditions.** At or above ceiling 800 feet and/or visibility 2 miles.

(1) No critical area protective action is provided under these conditions.

(2) A flight crew, under these conditions, should advise the tower that it will conduct an AUTOLAND or COUPLED approach.

EXAMPLE—

Denver Tower, United 1153, Request Autoland/Coupled Approach (runway)

ATC replies with:

United 1153, Denver Tower, Roger, Critical Areas not protected.

3. Aircraft holding below 5,000 feet between the outer marker and the airport may cause localizer signal variations for aircraft conducting the ILS approach. Accordingly, such holding is not autho-

ized when weather or visibility conditions are less than ceiling 800 feet and/or visibility 2 miles.

4. Pilots are cautioned that vehicular traffic not subject to ATC may cause momentary deviation to ILS course or glide slope signals. Also, critical areas are not protected at uncontrolled airports or at airports with an operating control tower when weather or visibility conditions are above those requiring protective measures. Aircraft conducting coupled or autoland operations should be especially alert in monitoring automatic flight control systems.

(See FIG 1-1-7.)

NOTE-

Unless otherwise coordinated through Flight Standards, ILS signals to Category I runways are not flight inspected below the point that is 100 feet less than the decision altitude (DA). Guidance signal anomalies may be encountered below this altitude.

1-1-10. Simplified Directional Facility (SDF)

a. The SDF provides a final approach course similar to that of the ILS localizer. It does not provide glide slope information. A clear understanding of the ILS localizer and the additional factors listed below completely describe the operational characteristics and use of the SDF.

b. The SDF transmits signals within the range of 108.10 to 111.95 MHz.

c. The approach techniques and procedures used in an SDF instrument approach are essentially the same as those employed in executing a standard localizer approach except the SDF course may not be aligned with the runway and the course may be wider, resulting in less precision.

d. Usable off-course indications are limited to 35 degrees either side of the course centerline. Instrument indications received beyond 35 degrees should be disregarded.

e. The SDF antenna may be offset from the runway centerline. Because of this, the angle of convergence between the final approach course and the runway bearing should be determined by reference to the instrument approach procedure chart. This angle is generally not more than 3 degrees. However, it should be noted that inasmuch as the approach course originates at the antenna site, an approach which is continued beyond the runway threshold will lead the aircraft to the SDF offset position rather than along the runway centerline.

f. The SDF signal is fixed at either 6 degrees or 12 degrees as necessary to provide maximum flyability and optimum course quality.

g. Identification consists of a three-letter identifier transmitted in Morse Code on the SDF frequency. The appropriate instrument approach chart will indicate the identifier used at a particular airport.

FIG 1-1-7
FAA Instrument Landing Systems

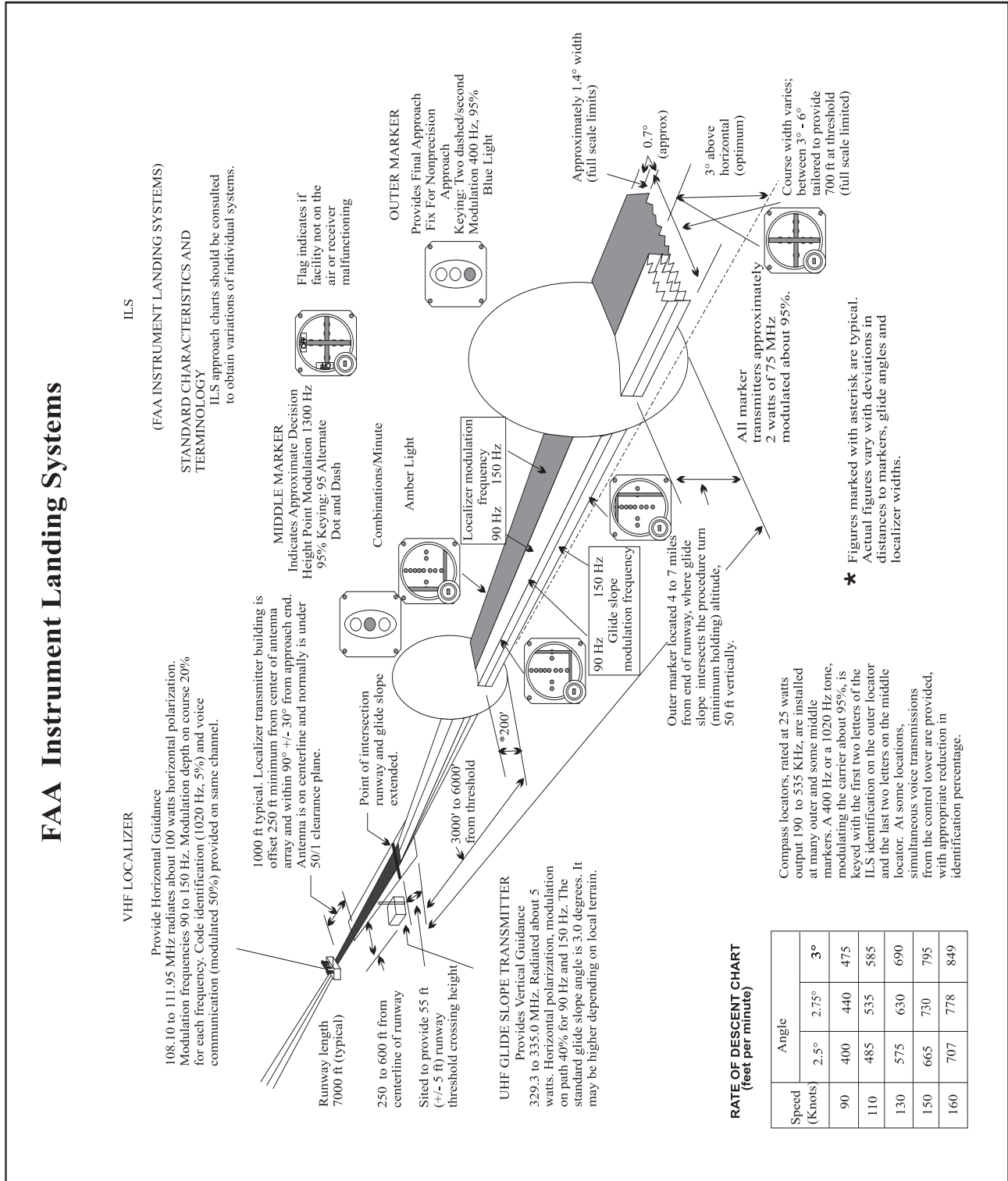

1-1-11. NAVAID Identifier Removal During Maintenance

During periods of routine or emergency maintenance, coded identification (or code and voice, where applicable) is removed from certain FAA NAVAIDs. Removal of identification serves as a warning to pilots that the facility is officially off the air for tune-up or repair and may be unreliable even though intermittent or constant signals are received.

NOTE-

During periods of maintenance VHF ranges may radiate a T-E-S-T code (- ● ● ● ● -).

NOTE-

DO NOT attempt to fly a procedure that is NOTAMed out of service even if the identification is present. In certain cases, the identification may be transmitted for short periods as part of the testing.

1-1-12. NAVAIDs with Voice

a. Voice equipped en route radio navigational aids are under the operational control of either a Flight Service Station (FSS) or an approach control facility. The voice communication is available on some facilities. Hazardous Inflight Weather Advisory Service (HIWAS) broadcast capability is available on selected VOR sites throughout the conterminous U.S. and does not provide two-way voice communication. The availability of two-way voice communication and HIWAS is indicated in the Chart Supplement U.S. and aeronautical charts.

b. Unless otherwise noted on the chart, all radio navigation aids operate continuously except during shutdowns for maintenance. Hours of operation of facilities not operating continuously are annotated on charts and in the Chart Supplement U.S.

1-1-13. User Reports Requested on NAVAID or Global Navigation Satellite System (GNSS) Performance or Interference

a. Users of the National Airspace System (NAS) can render valuable assistance in the early correction of NAVAID malfunctions or GNSS problems and are encouraged to report their observations of undesirable avionics performance. Although NAVAIDs are monitored by electronic detectors, adverse effects of electronic interference, new obstructions, or changes in terrain near the NAVAID can exist without

detection by the ground monitors. Some of the characteristics of malfunction or deteriorating performance which should be reported are: erratic course or bearing indications; intermittent, or full, flag alarm; garbled, missing or obviously improper coded identification; poor quality communications reception; or, in the case of frequency interference, an audible hum or tone accompanying radio communications or NAVAID identification. GNSS problems are often characterized by navigation degradation or service loss indications. For instance, pilots conducting operations in areas where there is GNSS interference may be unable to use GPS for navigation, and ADS-B may be unavailable for surveillance. Radio frequency interference may affect both navigation for the pilot and surveillance by the air traffic controller. Depending on the equipment and integration, either an advisory light or message may alert the pilot. Air traffic controllers monitoring ADS-B reports may stop receiving ADS-B position messages and associated aircraft tracks.

In addition, malfunctioning, faulty, inappropriately installed, operated, or modified GPS re-radiator systems, intended to be used for aircraft maintenance activities, have resulted in unintentional disruption of aviation GNSS receivers. This type of disruption could result in un-flagged, erroneous position information output to primary flight displays/indicators and to other aircraft and air traffic control systems. Since receiver autonomous integrity monitoring (RAIM) is only partially effective against this type of disruption (effectively a “signal spoofing”), the pilot may not be aware of any erroneous navigation indications; ATC may be the only means available for identification of these disruptions and detect unexpected aircraft position while monitoring aircraft for IFR separation.

b. Pilots reporting potential interference should identify the NAVAID (for example, VOR) malfunction or GNSS problem, location of the aircraft (that is, latitude, longitude or bearing/distance from a reference NAVAID), magnetic heading, altitude, date and time of the observation, type of aircraft (make/model/call sign), and description of the condition observed, and the type of receivers in use (that is, make/model/software revision). Reports should be made in any of the following ways:

1. Immediately, by voice radio communication to the controlling ATC facility or FSS.

2. By telephone to the nearest ATC facility controlling the airspace where the disruption was experienced.

3. Additionally, GNSS problems should be reported by Internet via the GPS Anomaly Reporting Form at http://www.faa.gov/air_traffic/nas/gps_reports/.

c. In aircraft equipped with more than one avionics receiver, there are many combinations of potential interference between units that could cause erroneous navigation indications, or complete or partial blanking out of the display.

NOTE–

GPS interference or outages associated with known testing NOTAMs should not be reported to ATC.

1–1–14. LORAN

NOTE–

In accordance with the 2010 DHS Appropriations Act, the U.S. Coast Guard (USCG) terminated the transmission of all U.S. LORAN–C signals on 08 Feb 2010. The USCG also terminated the transmission of the Russian American signals on 01 Aug 2010, and the Canadian LORAN–C signals on 03 Aug 2010. For more information, visit <http://www.navcen.uscg.gov>. Operators should also note that TSO–C60b, AIRBORNE AREA NAVIGATION EQUIPMENT USING LORAN–C INPUTS, has been canceled by the FAA.

1–1–15. Inertial Reference Unit (IRU), Inertial Navigation System (INS), and Attitude Heading Reference System (AHRS)

a. IRUs are self-contained systems comprised of gyros and accelerometers that provide aircraft attitude (pitch, roll, and heading), position, and velocity information in response to signals resulting from inertial effects on system components. Once aligned with a known position, IRUs continuously calculate position and velocity. IRU position accuracy decays with time. This degradation is known as “drift.”

b. INSs combine the components of an IRU with an internal navigation computer. By programming a series of waypoints, these systems will navigate along a predetermined track.

c. AHRSs are electronic devices that provide attitude information to aircraft systems such as

weather radar and autopilot, but do not directly compute position information.

d. Aircraft equipped with slaved compass systems may be susceptible to heading errors caused by exposure to magnetic field disturbances (flux fields) found in materials that are commonly located on the surface or buried under taxiways and ramps. These materials generate a magnetic flux field that can be sensed by the aircraft’s compass system flux detector or “gate”, which can cause the aircraft’s system to align with the material’s magnetic field rather than the earth’s natural magnetic field. The system’s erroneous heading may not self-correct. Prior to take off pilots should be aware that a heading misalignment may have occurred during taxi. Pilots are encouraged to follow the manufacturer’s or other appropriate procedures to correct possible heading misalignment before take off is commenced.

1–1–16. Doppler Radar

Doppler Radar is a semiautomatic self-contained dead reckoning navigation system (radar sensor plus computer) which is not continuously dependent on information derived from ground based or external aids. The system employs radar signals to detect and measure ground speed and drift angle, using the aircraft compass system as its directional reference. Doppler is less accurate than INS, however, and the use of an external reference is required for periodic updates if acceptable position accuracy is to be achieved on long range flights.

1–1–17. Global Positioning System (GPS)

a. System Overview

1. System Description. The Global Positioning System is a space-based radio navigation system used to determine precise position anywhere in the world. The 24 satellite constellation is designed to ensure at least five satellites are always visible to a user worldwide. A minimum of four satellites is necessary for receivers to establish an accurate three-dimensional position. The receiver uses data from satellites above the mask angle (the lowest angle above the horizon at which a receiver can use a satellite). The Department of Defense (DOD) is responsible for operating the GPS satellite constellation and monitors the GPS satellites to ensure proper operation. Each satellite’s orbital parameters (ephemeris data) are sent to each satellite for broadcast as

part of the data message embedded in the GPS signal. The GPS coordinate system is the Cartesian earth-centered, earth-fixed coordinates as specified in the World Geodetic System 1984 (WGS-84).

2. System Availability and Reliability.

(a) The status of GPS satellites is broadcast as part of the data message transmitted by the GPS satellites. GPS status information is also available by means of the U.S. Coast Guard navigation information service: (703) 313-5907, Internet: <http://www.navcen.uscg.gov/>. Additionally, satellite status is available through the Notice to Airmen (NOTAM) system.

(b) GNSS operational status depends on the type of equipment being used. For GPS-only equipment TSO-C129 or TSO-C196(), the operational status of non-precision approach capability for flight planning purposes is provided through a prediction program that is embedded in the receiver or provided separately.

3. Receiver Autonomous Integrity Monitoring (RAIM). RAIM is the capability of a GPS receiver to perform integrity monitoring on itself by ensuring available satellite signals meet the integrity requirements for a given phase of flight. Without RAIM, the pilot has no assurance of the GPS position integrity. RAIM provides immediate feedback to the pilot. This fault detection is critical for performance-based navigation (PBN)(see Paragraph 1-2-1, Performance-Based Navigation (PBN) and Area Navigation (RNAV), for an introduction to PBN), because delays of up to two hours can occur before an erroneous satellite transmission is detected and corrected by the satellite control segment.

(a) In order for RAIM to determine if a satellite is providing corrupted information, at least one satellite, in addition to those required for navigation, must be in view for the receiver to perform the RAIM function. RAIM requires a minimum of 5 satellites, or 4 satellites and barometric altimeter input (baro-aiding), to detect an integrity anomaly. Baro-aiding is a method of augmenting the GPS integrity solution by using a non-satellite input source in lieu of the fifth satellite. Some GPS receivers also have a RAIM capability, called fault detection and exclusion (FDE), that excludes a failed satellite from the position solution; GPS receivers capable of FDE require 6 satellites or 5 satellites with

baro-aiding. This allows the GPS receiver to isolate the corrupt satellite signal, remove it from the position solution, and still provide an integrity-assured position. To ensure that baro-aiding is available, enter the current altimeter setting into the receiver as described in the operating manual. Do not use the GPS derived altitude due to the large GPS vertical errors that will make the integrity monitoring function invalid.

(b) There are generally two types of RAIM fault messages. The first type of message indicates that there are not enough satellites available to provide RAIM integrity monitoring. The GPS navigation solution may be acceptable, but the integrity of the solution cannot be determined. The second type indicates that the RAIM integrity monitor has detected a potential error and that there is an inconsistency in the navigation solution for the given phase of flight. Without RAIM capability, the pilot has no assurance of the accuracy of the GPS position.

4. Selective Availability. Selective Availability (SA) is a method by which the accuracy of GPS is intentionally degraded. This feature was designed to deny hostile use of precise GPS positioning data. SA was discontinued on May 1, 2000, but many GPS receivers are designed to assume that SA is still active. New receivers may take advantage of the discontinuance of SA based on the performance values in ICAO Annex 10.

b. **Operational Use of GPS.** U.S. civil operators may use approved GPS equipment in oceanic airspace, certain remote areas, the National Airspace System and other States as authorized (please consult the applicable Aeronautical Information Publication). Equipage other than GPS may be required for the desired operation. GPS navigation is used for both Visual Flight Rules (VFR) and Instrument Flight Rules (IFR) operations.

1. VFR Operations

(a) GPS navigation has become an asset to VFR pilots by providing increased navigational capabilities and enhanced situational awareness. Although GPS has provided many benefits to the VFR pilot, care must be exercised to ensure that system capabilities are not exceeded. VFR pilots should integrate GPS navigation with electronic navigation (when possible), as well as pilotage and dead reckoning.

(b) GPS receivers used for VFR navigation vary from fully integrated IFR/VFR installation used to support VFR operations to hand-held devices. Pilots must understand the limitations of the receivers prior to using in flight to avoid misusing navigation information. (See TBL 1-1-6.) Most receivers are not intuitive. The pilot must learn the various keystrokes, knob functions, and displays that are used in the operation of the receiver. Some manufacturers provide computer-based tutorials or simulations of their receivers that pilots can use to become familiar with operating the equipment.

(c) When using GPS for VFR operations, RAIM capability, database currency, and antenna location are critical areas of concern.

(1) RAIM Capability. VFR GPS panel mount receivers and hand-held units have no RAIM alerting capability. This prevents the pilot from being alerted to the loss of the required number of satellites in view, or the detection of a position error. Pilots should use a systematic cross-check with other navigation techniques to verify position. Be suspicious of the GPS position if a disagreement exists between the two positions.

(2) Database Currency. Check the currency of the database. Databases must be updated for IFR operations and should be updated for all other operations. However, there is no requirement for databases to be updated for VFR navigation. It is not recommended to use a moving map with an outdated database in and around critical airspace. Pilots using an outdated database should verify waypoints using current aeronautical products; for example, Chart Supplement U.S., Sectional Chart, or En Route Chart.

(3) Antenna Location. The antenna location for GPS receivers used for IFR and VFR operations may differ. VFR antennae are typically placed for convenience more than performance, while IFR installations ensure a clear view is provided with the satellites. Antennae not providing a clear view have a greater opportunity to lose the satellite navigational signal. This is especially true in the case of hand-held GPS receivers. Typically, suction cups are used to place the GPS antennas on the inside of cockpit windows. While this method has great utility, the antenna location is limited to the cockpit or cabin which rarely provides a clear view of all available satellites. Consequently, signal losses

may occur due to aircraft structure blocking satellite signals, causing a loss of navigation capability. These losses, coupled with a lack of RAIM capability, could present erroneous position and navigation information with no warning to the pilot. While the use of a hand-held GPS for VFR operations is not limited by regulation, modification of the aircraft, such as installing a panel- or yoke-mounted holder, is governed by 14 CFR Part 43. Consult with your mechanic to ensure compliance with the regulation and safe installation.

(d) Do not solely rely on GPS for VFR navigation. No design standard of accuracy or integrity is used for a VFR GPS receiver. VFR GPS receivers should be used in conjunction with other forms of navigation during VFR operations to ensure a correct route of flight is maintained. Minimize head-down time in the aircraft by being familiar with your GPS receiver's operation and by keeping eyes outside scanning for traffic, terrain, and obstacles.

(e) VFR Waypoints

(1) VFR waypoints provide VFR pilots with a supplementary tool to assist with position awareness while navigating visually in aircraft equipped with area navigation receivers. VFR waypoints should be used as a tool to supplement current navigation procedures. The uses of VFR waypoints include providing navigational aids for pilots unfamiliar with an area, waypoint definition of existing reporting points, enhanced navigation in and around Class B and Class C airspace, and enhanced navigation around Special Use Airspace. VFR pilots should rely on appropriate and current aeronautical charts published specifically for visual navigation. If operating in a terminal area, pilots should take advantage of the Terminal Area Chart available for that area, if published. The use of VFR waypoints does not relieve the pilot of any responsibility to comply with the operational requirements of 14 CFR Part 91.

(2) VFR waypoint names (for computer-entry and flight plans) consist of five letters beginning with the letters "VP" and are retrievable from navigation databases. The VFR waypoint names are not intended to be pronounceable, and they are not for use in ATC communications. On VFR charts, stand-alone VFR waypoints will be portrayed using the same four-point star symbol used for IFR waypoints. VFR waypoints collocated with visual check points on the chart will be identified by small

magenta flag symbols. VFR waypoints collocated with visual check points will be pronounceable based on the name of the visual check point and may be used for ATC communications. Each VFR waypoint name will appear in parentheses adjacent to the geographic location on the chart. Latitude/longitude data for all established VFR waypoints may be found in the appropriate regional Chart Supplement U.S.

(3) VFR waypoints may not be used on IFR flight plans. VFR waypoints are not recognized by the IFR system and will be rejected for IFR routing purposes.

(4) Pilots may use the five-letter identifier as a waypoint in the route of flight section on a VFR flight plan. Pilots may use the VFR waypoints only when operating under VFR conditions. The point may represent an intended course change or describe the planned route of flight. This VFR filing would be similar to how a VOR would be used in a route of flight.

(5) VFR waypoints intended for use during flight should be loaded into the receiver while on the ground. Once airborne, pilots should avoid programming routes or VFR waypoint chains into their receivers.

(6) Pilots should be vigilant to see and avoid other traffic when near VFR waypoints. With the increased use of GPS navigation and accuracy, expect increased traffic near VFR waypoints. Regardless of the class of airspace, monitor the available ATC frequency for traffic information on other aircraft operating in the vicinity. See Paragraph 7-5-2, VFR in Congested Areas, for more information.

2. IFR Use of GPS

(a) **General Requirements.** Authorization to conduct any GPS operation under IFR requires:

(1) GPS navigation equipment used for IFR operations must be approved in accordance with the requirements specified in Technical Standard Order (TSO) TSO-C129(), TSO-C196(), TSO-C145(), or TSO-C146(), and the installation must be done in accordance with Advisory Circular AC 20-138, Airworthiness Approval of Positioning and Navigation Systems. Equipment approved in accordance with TSO-C115a does not meet the requirements of TSO-C129. Visual flight rules (VFR) and hand-held

GPS systems are not authorized for IFR navigation, instrument approaches, or as a principal instrument flight reference.

(2) Aircraft using un-augmented GPS (TSO-C129() or TSO-C196()) for navigation under IFR must be equipped with an alternate approved and operational means of navigation suitable for navigating the proposed route of flight. (Examples of alternate navigation equipment include VOR or DME/DME/IRU capability). Active monitoring of alternative navigation equipment is not required when RAIM is available for integrity monitoring. Active monitoring of an alternate means of navigation is required when the GPS RAIM capability is lost.

(3) Procedures must be established for use in the event that the loss of RAIM capability is predicted to occur. In situations where RAIM is predicted to be unavailable, the flight must rely on other approved navigation equipment, re-route to where RAIM is available, delay departure, or cancel the flight.

(4) The GPS operation must be conducted in accordance with the FAA-approved aircraft flight manual (AFM) or flight manual supplement. Flight crew members must be thoroughly familiar with the particular GPS equipment installed in the aircraft, the receiver operation manual, and the AFM or flight manual supplement. Operation, receiver presentation and capabilities of GPS equipment vary. Due to these differences, operation of GPS receivers of different brands, or even models of the same brand, under IFR should not be attempted without thorough operational knowledge. Most receivers have a built-in simulator mode, which allows the pilot to become familiar with operation prior to attempting operation in the aircraft.

(5) Aircraft navigating by IFR-approved GPS are considered to be performance-based navigation (PBN) aircraft and have special equipment suffixes. File the appropriate equipment suffix in accordance with TBL 5-1-3 on the ATC flight plan. If GPS avionics become inoperative, the pilot should advise ATC and amend the equipment suffix.

(6) Prior to any GPS IFR operation, the pilot must review appropriate NOTAMs and aeronautical information. (See GPS NOTAMs/Aeronautical Information).

(b) Database Requirements. The onboard navigation data must be current and appropriate for the region of intended operation and should include the navigation aids, waypoints, and relevant coded terminal airspace procedures for the departure, arrival, and alternate airfields.

(1) Further database guidance for terminal and en route requirements may be found in AC 90-100, U.S. Terminal and En Route Area Navigation (RNAV) Operations.

(2) Further database guidance on Required Navigation Performance (RNP) instrument approach operations, RNP terminal, and RNP en route requirements may be found in AC 90-105, Approval Guidance for RNP Operations and Barometric Vertical Navigation in the U.S. National Airspace System.

(3) All approach procedures to be flown must be retrievable from the current airborne navigation database supplied by the equipment manufacturer or other FAA-approved source. The system must be able to retrieve the procedure by name from the aircraft navigation database, not just as a manually entered series of waypoints. Manual entry of waypoints using latitude/longitude or place/bearing is not permitted for approach procedures.

(4) Prior to using a procedure or waypoint retrieved from the airborne navigation database, the pilot should verify the validity of the database. This verification should include the following preflight and inflight steps:

[a] Preflight:

[1] Determine the date of database issuance, and verify that the date/time of proposed use is before the expiration date/time.

[2] Verify that the database provider has not published a notice limiting the use of the specific waypoint or procedure.

[b] Inflight:

[1] Determine that the waypoints and transition names coincide with names found on the procedure chart. Do not use waypoints which do not exactly match the spelling shown on published procedure charts.

[2] Determine that the waypoints are logical in location, in the correct order, and their

orientation to each other is as found on the procedure chart, both laterally and vertically.

NOTE-

There is no specific requirement to check each waypoint latitude and longitude, type of waypoint and/or altitude constraint, only the general relationship of waypoints in the procedure, or the logic of an individual waypoint's location.

[3] If the cursory check of procedure logic or individual waypoint location, specified in [b] above, indicates a potential error, do not use the retrieved procedure or waypoint until a verification of latitude and longitude, waypoint type, and altitude constraints indicate full conformity with the published data.

(5) Air carrier and commercial operators must meet the appropriate provisions of their approved operations specifications.

[a] During domestic operations for commerce or for hire, operators must have a second navigation system capable of reversion or contingency operations.

[b] Operators must have two independent navigation systems appropriate to the route to be flown, or one system that is suitable and a second, independent backup capability that allows the operator to proceed safely and land at a different airport, and the aircraft must have sufficient fuel (reference 14 CFR 121.349, 125.203, 129.17, and 135.165). These rules ensure the safety of the operation by preventing a single point of failure.

NOTE-

An aircraft approved for multi-sensor navigation and equipped with a single navigation system must maintain an ability to navigate or proceed safely in the event that any one component of the navigation system fails, including the flight management system (FMS). Retaining a FMS-independent VOR capability would satisfy this requirement.

[c] The requirements for a second system apply to the entire set of equipment needed to achieve the navigation capability, not just the individual components of the system such as the radio navigation receiver. For example, to use two RNAV systems (e.g., GPS and DME/DME/IRU) to comply with the requirements, the aircraft must be equipped with two independent radio navigation receivers and two independent navigation computers (e.g., flight management systems (FMS)). Alternatively, to comply with the requirements using a single RNAV system with an installed and operable VOR

capability, the VOR capability must be independent of the FMS.

[d] To satisfy the requirement for two independent navigation systems, if the primary navigation system is GPS-based, the second system must be independent of GPS (for example, VOR or DME/DME/IRU). This allows continued navigation in case of failure of the GPS or WAAS services. Recognizing that GPS interference and test events resulting in the loss of GPS services have become more common, the FAA requires operators conducting IFR operations under 14 CFR 121.349, 125.203, 129.17 and 135.65 to retain a non-GPS navigation capability consisting of either DME/DME, IRU, or VOR for en route and terminal operations, and VOR and ILS for final approach. Since this system is to be used as a reversionary capability, single equipment is sufficient.

3. Oceanic, Domestic, En Route, and Terminal Area Operations

(a) Conduct GPS IFR operations in oceanic areas only when approved avionics systems are installed. TSO-C196() users and TSO-C129() GPS users authorized for Class A1, A2, B1, B2, C1, or C2 operations may use GPS in place of another approved means of long-range navigation, such as dual INS. (See TBL 1-1-5 and TBL 1-1-6.) Aircraft with a single installation GPS, meeting the above specifications, are authorized to operate on short oceanic routes requiring one means of long-range navigation (reference AC 20-138, Appendix 1).

(b) Conduct GPS domestic, en route, and terminal IFR operations only when approved avionics systems are installed. Pilots may use GPS via TSO-C129() authorized for Class A1, B1, B3, C1, or C3 operations GPS via TSO-C196(); or GPS/WAAS with either TSO-C145() or TSO-C146(). When using TSO-C129() or TSO-C196() receivers, the avionics necessary to receive all of the ground-based facilities appropriate for the route to the destination airport and any required alternate airport must be installed and operational. Ground-based facilities necessary for these routes must be operational.

(1) GPS en route IFR operations may be conducted in Alaska outside the operational service volume of ground-based navigation aids when a TSO-C145() or TSO-C146() GPS/wide area aug-

mentation system (WAAS) system is installed and operating. WAAS is the U.S. version of a satellite-based augmentation system (SBAS).

[a] In Alaska, aircraft may operate on GNSS Q-routes with GPS (TSO-C129 () or TSO-C196 ()) equipment while the aircraft remains in Air Traffic Control (ATC) radar surveillance or with GPS/WAAS (TSO-C145 () or TSO-C146 ()) which does not require ATC radar surveillance.

[b] In Alaska, aircraft may only operate on GNSS T-routes with GPS/WAAS (TSO-C145 () or TSO-C146 ()) equipment.

(2) Ground-based navigation equipment is not required to be installed and operating for en route IFR operations when using GPS/WAAS navigation systems. All operators should ensure that an alternate means of navigation is available in the unlikely event the GPS/WAAS navigation system becomes inoperative.

(3) Q-routes and T-routes outside Alaska. Q-routes require system performance currently met by GPS, GPS/WAAS, or DME/DME/IRU RNAV systems that satisfy the criteria discussed in AC 90-100, U.S. Terminal and En Route Area Navigation (RNAV) Operations. T-routes require GPS or GPS/WAAS equipment.

REFERENCE-

AIM, Paragraph 5-3-4, Airways and Route Systems

(c) GPS IFR approach/departure operations can be conducted when approved avionics systems are installed and the following requirements are met:

(1) The aircraft is TSO-C145() or TSO-C146() or TSO-C196() or TSO-C129() in Class A1, B1, B3, C1, or C3; and

(2) The approach/departure must be retrievable from the current airborne navigation database in the navigation computer. The system must be able to retrieve the procedure by name from the aircraft navigation database. Manual entry of waypoints using latitude/longitude or place/bearing is not permitted for approach procedures.

(3) The authorization to fly instrument approaches/departures with GPS is limited to U.S. airspace.

(4) The use of GPS in any other airspace must be expressly authorized by the FAA Administrator.

(5) GPS instrument approach/departure operations outside the U.S. must be authorized by the appropriate sovereign authority.

4. Departures and Instrument Departure Procedures (DPs)

The GPS receiver must be set to terminal (± 1 NM) CDI sensitivity and the navigation routes contained in the database in order to fly published IFR charted departures and DPs. Terminal RAIM should be automatically provided by the receiver. (Terminal RAIM for departure may not be available unless the waypoints are part of the active flight plan rather than proceeding direct to the first destination.) Certain segments of a DP may require some manual intervention by the pilot, especially when radar vectored to a course or required to intercept a specific course to a waypoint. The database may not contain all of the transitions or departures from all runways and some GPS receivers do not contain DPs in the database. It is necessary that helicopter procedures be flown at 70 knots or less since helicopter departure procedures and missed approaches use a 20:1 obstacle clearance surface (OCS), which is double the fixed-wing OCS, and turning areas are based on this speed as well.

5. GPS Instrument Approach Procedures

(a) GPS overlay approaches are designated non-precision instrument approach procedures that pilots are authorized to fly using GPS avionics. Localizer (LOC), localizer type directional aid (LDA), and simplified directional facility (SDF) procedures are not authorized. Overlay procedures are identified by the “name of the procedure” and “or GPS” (e.g., VOR/DME or GPS RWY 15) in the title. Authorized procedures must be retrievable from a current onboard navigation database. The navigation database may also enhance position orientation by displaying a map containing information on conventional NAVAID approaches. This approach information should not be confused with a GPS overlay approach (see the receiver operating manual, AFM, or AFM Supplement for details on how to identify these approaches in the navigation database).

NOTE—

Overlay approaches do not adhere to the design criteria described in Paragraph 5–4–5m, Area Navigation (RNAV) Instrument Approach Charts, for stand-alone GPS

approaches. Overlay approach criteria is based on the design criteria used for ground-based NAVAID approaches.

(b) Stand-alone approach procedures specifically designed for GPS systems have replaced many of the original overlay approaches. All approaches that contain “GPS” in the title (e.g., “VOR or GPS RWY 24,” “GPS RWY 24,” or “RNAV (GPS) RWY 24”) can be flown using GPS. GPS-equipped aircraft do not need underlying ground-based NAVAIDs or associated aircraft avionics to fly the approach. Monitoring the underlying approach with ground-based NAVAIDs is suggested when able. Existing overlay approaches may be requested using the GPS title; for example, the VOR or GPS RWY 24 may be requested as “GPS RWY 24.” Some GPS procedures have a Terminal Arrival Area (TAA) with an underlining RNAV approach.

(c) For flight planning purposes, TSO-C129() and TSO-C196()–equipped users (GPS users) whose navigation systems have fault detection and exclusion (FDE) capability, who perform a preflight RAIM prediction for the approach integrity at the airport where the RNAV (GPS) approach will be flown, and have proper knowledge and any required training and/or approval to conduct a GPS-based IAP, may file based on a GPS-based IAP at either the destination or the alternate airport, but not at both locations. At the alternate airport, pilots may plan for:

(1) Lateral navigation (LNAV) or circling minimum descent altitude (MDA);

(2) LNAV/vertical navigation (LNAV/VNAV) DA, if equipped with and using approved barometric vertical navigation (baro-VNAV) equipment;

(3) RNP 0.3 DA on an RNAV (RNP) IAP, if they are specifically authorized users using approved baro-VNAV equipment and the pilot has verified required navigation performance (RNP) availability through an approved prediction program.

(d) If the above conditions cannot be met, any required alternate airport must have an approved instrument approach procedure other than GPS-based that is anticipated to be operational and available at the estimated time of arrival, and which the aircraft is equipped to fly.

(e) Procedures for Accomplishing GPS Approaches

(1) An RNAV (GPS) procedure may be associated with a Terminal Arrival Area (TAA). The basic design of the RNAV procedure is the “T” design or a modification of the “T” (See Paragraph 5-4-5d, Terminal Arrival Area (TAA), for complete information).

(2) Pilots cleared by ATC for an RNAV (GPS) approach should fly the full approach from an Initial Approach Waypoint (IAWP) or feeder fix. Randomly joining an approach at an intermediate fix does not assure terrain clearance.

(3) When an approach has been loaded in the navigation system, GPS receivers will give an “arm” annunciation 30 NM straight line distance from the airport/heliport reference point. Pilots should arm the approach mode at this time if not already armed (some receivers arm automatically). Without arming, the receiver will not change from en route CDI and RAIM sensitivity of ± 5 NM either side of centerline to ± 1 NM terminal sensitivity. Where the IAWP is inside this 30 mile point, a CDI sensitivity change will occur once the approach mode is armed and the aircraft is inside 30 NM. Where the IAWP is beyond 30 NM from the airport/heliport reference point and the approach is armed, the CDI sensitivity will not change until the aircraft is within 30 miles of the airport/heliport reference point. Feeder route obstacle clearance is predicated on the receiver being in terminal (± 1 NM) CDI sensitivity and RAIM within 30 NM of the airport/heliport reference point; therefore, the receiver should always be armed (if required) not later than the 30 NM annunciation.

(4) The pilot must be aware of what bank angle/turn rate the particular receiver uses to compute turn anticipation, and whether wind and airspeed are included in the receiver’s calculations. This information should be in the receiver operating manual. Over or under banking the turn onto the final approach course may significantly delay getting on course and may result in high descent rates to achieve the next segment altitude.

(5) When within 2 NM of the Final Approach Waypoint (FAWP) with the approach mode armed, the approach mode will switch to active, which results in RAIM and CDI changing to

approach sensitivity. Beginning 2 NM prior to the FAWP, the full scale CDI sensitivity will smoothly change from ± 1 NM to ± 0.3 NM at the FAWP. As sensitivity changes from ± 1 NM to ± 0.3 NM approaching the FAWP, with the CDI not centered, the corresponding increase in CDI displacement may give the impression that the aircraft is moving further away from the intended course even though it is on an acceptable intercept heading. Referencing the digital track displacement information (cross track error), if it is available in the approach mode, may help the pilot remain position oriented in this situation. Being established on the final approach course prior to the beginning of the sensitivity change at 2 NM will help prevent problems in interpreting the CDI display during ramp down. Therefore, requesting or accepting vectors which will cause the aircraft to intercept the final approach course within 2 NM of the FAWP is not recommended.

(6) When receiving vectors to final, most receiver operating manuals suggest placing the receiver in the non-sequencing mode on the FAWP and manually setting the course. This provides an extended final approach course in cases where the aircraft is vectored onto the final approach course outside of any existing segment which is aligned with the runway. Assigned altitudes must be maintained until established on a published segment of the approach. Required altitudes at waypoints outside the FAWP or stepdown fixes must be considered. Calculating the distance to the FAWP may be required in order to descend at the proper location.

(7) Overriding an automatically selected sensitivity during an approach will cancel the approach mode annunciation. If the approach mode is not armed by 2 NM prior to the FAWP, the approach mode will not become active at 2 NM prior to the FAWP, and the equipment will flag. In these conditions, the RAIM and CDI sensitivity will not ramp down, and the pilot should not descend to MDA, but fly to the MAWP and execute a missed approach. The approach active annunciator and/or the receiver should be checked to ensure the approach mode is active prior to the FAWP.

(8) Do not attempt to fly an approach unless the procedure in the onboard database is current and identified as “GPS” on the approach chart. The navigation database may contain information about non-overlay approach procedures that enhances position orientation generally by providing a map,

while flying these approaches using conventional NAVAIDs. This approach information should not be confused with a GPS overlay approach (see the receiver operating manual, AFM, or AFM Supplement for details on how to identify these procedures in the navigation database). Flying point to point on the approach does not assure compliance with the published approach procedure. The proper RAIM sensitivity will not be available and the CDI sensitivity will not automatically change to ± 0.3 NM. Manually setting CDI sensitivity does not automatically change the RAIM sensitivity on some receivers. Some existing non-precision approach procedures cannot be coded for use with GPS and will not be available as overlays.

(9) Pilots should pay particular attention to the exact operation of their GPS receivers for performing holding patterns and in the case of overlay approaches, operations such as procedure turns. These procedures may require manual intervention by the pilot to stop the sequencing of waypoints by the receiver and to resume automatic GPS navigation sequencing once the maneuver is complete. The same waypoint may appear in the route of flight more than once consecutively (for example, IAWP, FAWP, MAHWP on a procedure turn). Care must be exercised to ensure that the receiver is sequenced to the appropriate waypoint for the segment of the procedure being flown, especially if one or more fly-overs are skipped (for example, FAWP rather than IAWP if the procedure turn is not flown). The pilot may have to sequence past one or more fly-overs of the same waypoint in order to start GPS automatic sequencing at the proper place in the sequence of waypoints.

(10) Incorrect inputs into the GPS receiver are especially critical during approaches. In some cases, an incorrect entry can cause the receiver to leave the approach mode.

(11) A fix on an overlay approach identified by a DME fix will not be in the waypoint sequence on the GPS receiver unless there is a published name assigned to it. When a name is assigned, the along track distance (ATD) to the waypoint may be zero rather than the DME stated on the approach chart. The pilot should be alert for this on any overlay procedure where the original approach used DME.

(12) If a visual descent point (VDP) is published, it will not be included in the sequence of waypoints. Pilots are expected to use normal piloting techniques for beginning the visual descent, such as ATD.

(13) Unnamed stepdown fixes in the final approach segment may or may not be coded in the waypoint sequence of the aircraft's navigation database and must be identified using ATD. Stepdown fixes in the final approach segment of RNAV (GPS) approaches are being named, in addition to being identified by ATD. However, GPS avionics may or may not accommodate waypoints between the FAF and MAP. Pilots must know the capabilities of their GPS equipment and continue to identify stepdown fixes using ATD when necessary.

(f) Missed Approach

(1) A GPS missed approach requires pilot action to sequence the receiver past the MAWP to the missed approach portion of the procedure. The pilot must be thoroughly familiar with the activation procedure for the particular GPS receiver installed in the aircraft and must initiate appropriate action after the MAWP. Activating the missed approach prior to the MAWP will cause CDI sensitivity to immediately change to terminal (± 1 NM) sensitivity and the receiver will continue to navigate to the MAWP. The receiver will not sequence past the MAWP. Turns should not begin prior to the MAWP. If the missed approach is not activated, the GPS receiver will display an extension of the inbound final approach course and the ATD will increase from the MAWP until it is manually sequenced after crossing the MAWP.

(2) Missed approach routings in which the first track is via a course rather than direct to the next waypoint require additional action by the pilot to set the course. Being familiar with all of the inputs required is especially critical during this phase of flight.

(g) GPS NOTAMs/Aeronautical Information

(1) GPS satellite outages are issued as GPS NOTAMs both domestically and internationally. However, the effect of an outage on the intended operation cannot be determined unless the pilot has a RAIM availability prediction program which allows excluding a satellite which is predicted to be out of service based on the NOTAM information.

(2) The terms UNRELIABLE and MAY NOT BE AVAILABLE are used in conjunction with GPS NOTAMS. Both UNRELIABLE and MAY NOT BE AVAILABLE are advisories to pilots indicating the expected level of service may not be available. UNRELIABLE does not mean there is a problem with GPS signal integrity. If GPS service is available, pilots may continue operations. If the LNAV or LNAV/VNAV service is available, pilots may use the displayed level of service to fly the approach. GPS operation may be NOTAMed UNRELIABLE or MAY NOT BE AVAILABLE due to testing or anomalies. (Pilots are encouraged to report GPS anomalies, including degraded operation and/or loss of service, as soon as possible, reference paragraph 1–1–13.) When GPS testing NOTAMS are published and testing is actually occurring, Air Traffic Control will advise pilots requesting or cleared for a GPS or RNAV (GPS) approach that GPS may not be available and request intentions. If pilots have reported GPS anomalies, Air Traffic Control will request the pilot’s intentions and/or clear the pilot for an alternate approach, if available and operational.

EXAMPLE–

The following is an example of a GPS testing NOTAM: /GPS 06/001 ZAB NAV GPS (INCLUDING WAAS, GBAS, AND ADS-B) MAY NOT BE AVAILABLE WITHIN A 468NM RADIUS CENTERED AT 330702N1062540W (TCS 093044) FL400-UNL DECREASING IN AREA WITH A DECREASE IN ALTITUDE DEFINED AS: 425NM RADIUS AT FL250, 360NM RADIUS AT 10000FT, 354NM RADIUS AT 4000FT AGL, 327NM RADIUS AT 50FT AGL. 1406070300-1406071200.

(3) Civilian pilots may obtain GPS RAIM availability information for non–precision approach procedures by using a manufacturer-supplied RAIM prediction tool, or using the Service Availability Prediction Tool (SAPT) on the FAA en route and terminal RAIM prediction website. Pilots can also request GPS RAIM aeronautical information from a flight service station during preflight briefings. GPS RAIM aeronautical information can be obtained for a period of 3 hours (for example, if you are scheduled to arrive at 1215 hours, then the GPS RAIM information is available from 1100 to 1400 hours) or a 24–hour timeframe at a particular airport. FAA briefers will provide RAIM information for a period of 1 hour before to 1 hour after the ETA hour, unless a specific timeframe is requested by the pilot. If flying a published GPS departure, a RAIM prediction should also be requested for the departure airport.

(4) The military provides airfield specific GPS RAIM NOTAMs for non–precision approach procedures at military airfields. The RAIM outages are issued as M–series NOTAMs and may be obtained for up to 24 hours from the time of request.

(5) Receiver manufacturers and/or database suppliers may supply “NOTAM” type information concerning database errors. Pilots should check these sources, when available, to ensure that they have the most current information concerning their electronic database.

(h) Receiver Autonomous Integrity Monitoring (RAIM)

(1) RAIM outages may occur due to an insufficient number of satellites or due to unsuitable satellite geometry which causes the error in the position solution to become too large. Loss of satellite reception and RAIM warnings may occur due to aircraft dynamics (changes in pitch or bank angle). Antenna location on the aircraft, satellite position relative to the horizon, and aircraft attitude may affect reception of one or more satellites. Since the relative positions of the satellites are constantly changing, prior experience with the airport does not guarantee reception at all times, and RAIM availability should always be checked.

(2) If RAIM is not available, use another type of navigation and approach system, select another route or destination, or delay the trip until RAIM is predicted to be available on arrival. On longer flights, pilots should consider rechecking the RAIM prediction for the destination during the flight. This may provide an early indication that an unscheduled satellite outage has occurred since takeoff.

(3) If a RAIM failure/status annunciation occurs prior to the final approach waypoint (FAWP), the approach should not be completed since GPS no longer provides the required integrity. The receiver performs a RAIM prediction by 2 NM prior to the FAWP to ensure that RAIM is available as a condition for entering the approach mode. The pilot should ensure the receiver has sequenced from “Armed” to “Approach” prior to the FAWP (normally occurs 2 NM prior). Failure to sequence may be an indication of the detection of a satellite anomaly, failure to arm the receiver (if required), or other problems which preclude flying the approach.

(4) If the receiver does not sequence into the approach mode or a RAIM failure/status annunciation occurs prior to the FAWP, the pilot must not initiate the approach or descend, but instead proceed to the missed approach waypoint (MAWP) via the FAWP, perform a missed approach, and contact ATC as soon as practical. The GPS receiver may continue to operate after a RAIM flag/status annunciation appears, but the navigation information should be considered advisory only. Refer to the receiver operating manual for specific indications and instructions associated with loss of RAIM prior to the FAF.

(5) If the RAIM flag/status annunciation appears after the FAWP, the pilot should initiate a climb and execute the missed approach. The GPS receiver may continue to operate after a RAIM flag/status annunciation appears, but the navigation information should be considered advisory only. Refer to the receiver operating manual for operating mode information during a RAIM annunciation.

(i) Waypoints

(1) GPS receivers navigate from one defined point to another retrieved from the aircraft's onboard navigational database. These points are waypoints (5-letter pronounceable name), existing VHF intersections, DME fixes with 5-letter pronounceable names and 3-letter NAVAID IDs. Each waypoint is a geographical location defined by a latitude/longitude geographic coordinate. These 5-letter waypoints, VHF intersections, 5-letter pronounceable DME fixes and 3-letter NAVAID IDs are published on various FAA aeronautical navigation products (IFR Enroute Charts, VFR Charts, Terminal Procedures Publications, etc.).

(2) A Computer Navigation Fix (CNF) is also a point defined by a latitude/longitude coordinate and is required to support Performance-Based Navigation (PBN) operations. The GPS receiver uses CNFs in conjunction with waypoints to navigate from point to point. However, CNFs are not recognized by ATC. ATC does not maintain CNFs in their database and they do not use CNFs for any air traffic control purpose. CNFs may or may not be charted on FAA aeronautical navigation products, are listed in the chart legends, and are for advisory purposes only.

Pilots are not to use CNFs for point to point navigation (proceed direct), filing a flight plan, or in aircraft/ATC communications. CNFs that do appear on aeronautical charts allow pilots increased situational awareness by identifying points in the aircraft database route of flight with points on the aeronautical chart. CNFs are random five-letter identifiers, not pronounceable like waypoints and placed in parenthesis. Eventually, all CNFs will begin with the letters "CF" followed by three consonants (for example, CFWBG). This five-letter identifier will be found next to an "x" on enroute charts and possibly on an approach chart. On instrument approach procedures (charts) in the terminal procedures publication, CNFs may represent unnamed DME fixes, beginning and ending points of DME arcs, and sensor (ground-based signal i.e., VOR, NDB, ILS) final approach fixes on GPS overlay approaches. These CNFs provide the GPS with points on the procedure that allow the overlay approach to mirror the ground-based sensor approach. These points should only be used by the GPS system for navigation and should not be used by pilots for any other purpose on the approach. The CNF concept has not been adopted or recognized by the International Civil Aviation Organization (ICAO).

(3) GPS approaches use fly-over and fly-by waypoints to join route segments on an approach. Fly-by waypoints connect the two segments by allowing the aircraft to turn prior to the current waypoint in order to roll out on course to the next waypoint. This is known as turn anticipation and is compensated for in the airspace and terrain clearances. The MAWP and the missed approach holding waypoint (MAHWP) are normally the only two waypoints on the approach that are not fly-by waypoints. Fly-over waypoints are used when the aircraft must overfly the waypoint prior to starting a turn to the new course. The symbol for a fly-over waypoint is a circled waypoint. Some waypoints may have dual use; for example, as a fly-by waypoint when used as an IF for a NoPT route and as a fly-over waypoint when the same waypoint is also used as an IAF/IF hold-in-lieu of PT. When this occurs, the less restrictive (fly-by) symbology will be charted. Overlay approach charts and some early stand-alone GPS approach charts may not reflect this convention.

(4) Unnamed waypoints for each airport will be uniquely identified in the database. Although the identifier may be used at different airports (for example, RW36 will be the identifier at each airport with a runway 36), the actual point, at each airport, is defined by a specific latitude/longitude coordinate.

(5) The runway threshold waypoint, normally the MAWP, may have a five-letter identifier (for example, SNEEZ) or be coded as RW## (for example, RW36, RW36L). MAWPs located at the runway threshold are being changed to the RW## identifier, while MAWPs not located at the threshold will have a five-letter identifier. This may cause the approach chart to differ from the aircraft database until all changes are complete. The runway threshold waypoint is also used as the center of the Minimum Safe Altitude (MSA) on most GPS approaches.

(j) Position Orientation.

Pilots should pay particular attention to position orientation while using GPS. Distance and track information are provided to the next active waypoint, not to a fixed navigation aid. Receivers may sequence when the pilot is not flying along an active route, such as when being vectored or deviating for weather, due to the proximity to another waypoint in the route. This can be prevented by placing the receiver in the non-sequencing mode. When the receiver is in the non-sequencing mode, bearing and distance are provided to the selected waypoint and the receiver will not sequence to the next waypoint in the route until placed back in the auto sequence mode or the pilot selects a different waypoint. The pilot may have to compute the ATD to stepdown fixes and other points on overlay approaches, due to the receiver showing ATD to the next waypoint rather than DME to the VOR or ILS ground station.

(k) Impact of Magnetic Variation on PBN Systems

(1) Differences may exist between PBN systems and the charted magnetic courses on ground-based NAVAID instrument flight procedures (IFP), enroute charts, approach charts, and Standard Instrument Departure/Standard Terminal Arrival (SID/STAR) charts. These differences are due to the magnetic variance used to calculate the magnetic

course. Every leg of an instrument procedure is first computed along a desired ground track with reference to true north. A magnetic variation correction is then applied to the true course in order to calculate a magnetic course for publication. The type of procedure will determine what magnetic variation value is added to the true course. A ground-based NAVAID IFP applies the facility magnetic variation of record to the true course to get the charted magnetic course. Magnetic courses on PBN procedures are calculated two different ways. SID/STAR procedures use the airport magnetic variation of record, while IFR enroute charts use magnetic reference bearing. PBN systems make a correction to true north by adding a magnetic variation calculated with an algorithm based on aircraft position, or by adding the magnetic variation coded in their navigational database. This may result in the PBN system and the procedure designer using a different magnetic variation, which causes the magnetic course *displayed* by the PBN system and the magnetic course *charted* on the IFP plate to be different. It is important to understand, however, that PBN systems, (with the exception of VOR/DME RNAV equipment) navigate by reference to true north and display magnetic course only for pilot reference. As such, a *properly functioning* PBN system, containing a *current and accurate navigational database*, should fly the correct ground track for any loaded instrument procedure, despite differences in displayed magnetic course that may be attributed to magnetic variation application. Should significant differences between the approach chart and the PBN system avionics' application of the navigation database arise, the published approach chart, supplemented by NOT-AMs, holds precedence.

(2) The course into a waypoint may not always be 180 degrees different from the course leaving the previous waypoint, due to the PBN system avionics' computation of geodesic paths, distance between waypoints, and differences in magnetic variation application. Variations in distances may also occur since PBN system distance-to-waypoint values are ATDs computed to the next waypoint and the DME values published on underlying procedures are slant-range distances measured to the station. This difference increases with aircraft altitude and proximity to the NAVAID.

(I) GPS Familiarization

Pilots should practice GPS approaches in visual meteorological conditions (VMC) until thoroughly proficient with all aspects of their equipment (receiver and installation) prior to attempting flight in instrument meteorological conditions (IMC). Pilots should be proficient in the following areas:

- (1) Using the receiver autonomous integrity monitoring (RAIM) prediction function;
- (2) Inserting a DP into the flight plan, including setting terminal CDI sensitivity, if required, and the conditions under which terminal RAIM is available for departure;
- (3) Programming the destination airport;
- (4) Programming and flying the approaches (especially procedure turns and arcs);

- (5) Changing to another approach after selecting an approach;
- (6) Programming and flying “direct” missed approaches;
- (7) Programming and flying “routed” missed approaches;
- (8) Entering, flying, and exiting holding patterns, particularly on approaches with a second waypoint in the holding pattern;
- (9) Programming and flying a “route” from a holding pattern;
- (10) Programming and flying an approach with radar vectors to the intermediate segment;
- (11) Indication of the actions required for RAIM failure both before and after the FAWP; and
- (12) Programming a radial and distance from a VOR (often used in departure instructions).

TBL 1-1-5
GPS IFR Equipment Classes/Categories

TSO-C129						
Equipment Class	RAIM	Int. Nav. Sys. to Prov. RAIM Equiv.	Oceanic	En Route	Terminal	Non-precision Approach Capable
Class A – GPS sensor and navigation capability.						
A1	yes		yes	yes	yes	yes
A2	yes		yes	yes	yes	no
Class B – GPS sensor data to an integrated navigation system (i.e., FMS, multi-sensor navigation system, etc.).						
B1	yes		yes	yes	yes	yes
B2	yes		yes	yes	yes	no
B3		yes	yes	yes	yes	yes
B4		yes	yes	yes	yes	no
Class C – GPS sensor data to an integrated navigation system (as in Class B) which provides enhanced guidance to an autopilot, or flight director, to reduce flight tech. errors. Limited to 14 CFR Part 121 or equivalent criteria.						
C1	yes		yes	yes	yes	yes
C2	yes		yes	yes	yes	no
C3		yes	yes	yes	yes	yes
C4		yes	yes	yes	yes	no

**TBL 1-1-6
GPS Approval Required/Authorized Use**

Equipment Type ¹	Installation Approval Required	Operational Approval Required	IFR En Route ²	IFR Terminal ²	IFR Approach ³	Oceanic Remote	In Lieu of ADF and/or DME ³
Hand held ⁴	X ⁵						
VFR Panel Mount ⁴	X						
IFR En Route and Terminal	X	X	X	X			X
IFR Oceanic/Remote	X	X	X	X		X	X
IFR En Route, Terminal, and Approach	X	X	X	X	X		X

NOTE-

- ¹To determine equipment approvals and limitations, refer to the AFM, AFM supplements, or pilot guides.
- ²Requires verification of data for correctness if database is expired.
- ³Requires current database or verification that the procedure has not been amended since the expiration of the database.
- ⁴VFR and hand-held GPS systems are not authorized for IFR navigation, instrument approaches, or as a primary instrument flight reference. During IFR operations they may be considered only an aid to situational awareness.
- ⁵Hand-held receivers require no approval. However, any aircraft modification to support the hand-held receiver; i.e., installation of an external antenna or a permanent mounting bracket, does require approval.

1-1-18. Wide Area Augmentation System (WAAS)

a. General

1. The FAA developed the WAAS to improve the accuracy, integrity and availability of GPS signals. WAAS will allow GPS to be used, as the aviation navigation system, from takeoff through approach when it is complete. WAAS is a critical component of the FAA’s strategic objective for a seamless satellite navigation system for civil aviation, improving capacity and safety.

2. The International Civil Aviation Organization (ICAO) has defined Standards and Recommended Practices (SARPs) for satellite-based augmentation systems (SBAS) such as WAAS. Japan, India, and Europe are building similar systems: EGNOS, the European Geostationary Navigation Overlay System; India’s GPS and Geo-Augmented Navigation (GAGAN) system; and Japan’s Multi-functional Transport Satellite (MT-SAT)-based Satellite Augmentation System (MSAS). The merging of these systems will create an expansive navigation capability similar to GPS, but with greater accuracy, availability, and integrity.

3. Unlike traditional ground-based navigation aids, WAAS will cover a more extensive service area. Precisely surveyed wide-area reference stations (WRS) are linked to form the U.S. WAAS network. Signals from the GPS satellites are monitored by these WRSs to determine satellite clock and ephemeris corrections and to model the propagation effects of the ionosphere. Each station in the network relays the data to a wide-area master station (WMS) where the correction information is computed. A correction message is prepared and uplinked to a geostationary earth orbit satellite (GEO) via a GEO uplink subsystem (GUS) which is located at the ground earth station (GES). The message is then broadcast on the same frequency as GPS (L1, 1575.42 MHz) to WAAS receivers within the broadcast coverage area of the WAAS GEO.

4. In addition to providing the correction signal, the WAAS GEO provides an additional pseudorange measurement to the aircraft receiver, improving the availability of GPS by providing, in effect, an additional GPS satellite in view. The integrity of GPS is improved through real-time monitoring, and the accuracy is improved by providing differential corrections to reduce errors. The performance

improvement is sufficient to enable approach procedures with GPS/WAAS glide paths (vertical guidance).

5. The FAA has completed installation of 3 GEO satellite links, 38 WRSs, 3 WMSs, 6 GES, and the required terrestrial communications to support the WAAS network including 2 operational control centers. Prior to the commissioning of the WAAS for public use, the FAA conducted a series of test and validation activities. Future dual frequency operations are planned.

6. GNSS navigation, including GPS and WAAS, is referenced to the WGS-84 coordinate system. It should only be used where the Aeronautical Information Publications (including electronic data and aeronautical charts) conform to WGS-84 or equivalent. Other countries' civil aviation authorities may impose additional limitations on the use of their SBAS systems.

b. Instrument Approach Capabilities

1. A class of approach procedures which provide vertical guidance, but which do not meet the ICAO Annex 10 requirements for precision approaches has been developed to support satellite navigation use for aviation applications worldwide. These procedures are not precision and are referred to as Approach with Vertical Guidance (APV), are defined in ICAO Annex 6, and include approaches such as the LNAV/VNAV and localizer performance with vertical guidance (LPV). These approaches provide vertical guidance, but do not meet the more stringent standards of a precision approach. Properly certified WAAS receivers will be able to fly to LPV minima and LNAV/VNAV minima, using a WAAS electronic glide path, which eliminates the errors that can be introduced by using Barometric altimetry.

2. LPV minima takes advantage of the high accuracy guidance and increased integrity provided by WAAS. This WAAS generated angular guidance allows the use of the same TERPS approach criteria used for ILS approaches. LPV minima may have a decision altitude as low as 200 feet height above touchdown with visibility minimums as low as $\frac{1}{2}$ mile, when the terrain and airport infrastructure support the lowest minima. LPV minima is published on the RNAV (GPS) approach charts (see Paragraph 5-4-5, Instrument Approach Procedure Charts).

3. A different WAAS-based line of minima, called Localizer Performance (LP) is being added in locations where the terrain or obstructions do not allow publication of vertically guided LPV minima. LP takes advantage of the angular lateral guidance and smaller position errors provided by WAAS to provide a lateral only procedure similar to an ILS Localizer. LP procedures may provide lower minima than a LNAV procedure due to the narrower obstacle clearance surface.

NOTE-

WAAS receivers certified prior to TSO-C145b and TSO-C146b, even if they have LPV capability, do not contain LP capability unless the receiver has been upgraded. Receivers capable of flying LP procedures must contain a statement in the Aircraft Flight Manual (AFM), AFM Supplement, or Approved Supplemental Flight Manual stating that the receiver has LP capability, as well as the capability for the other WAAS and GPS approach procedure types.

4. WAAS provides a level of service that supports all phases of flight, including RNAV (GPS) approaches to LNAV, LP, LNAV/VNAV, and LPV lines of minima, within system coverage. Some locations close to the edge of the coverage may have a lower availability of vertical guidance.

c. General Requirements

1. WAAS avionics must be certified in accordance with Technical Standard Order (TSO) TSO-C145(), Airborne Navigation Sensors Using the (GPS) Augmented by the Wide Area Augmentation System (WAAS); or TSO-C146(), Stand-Alone Airborne Navigation Equipment Using the Global Positioning System (GPS) Augmented by the Wide Area Augmentation System (WAAS), and installed in accordance with AC 20-138, Airworthiness Approval of Positioning and Navigation Systems.

2. GPS/WAAS operation must be conducted in accordance with the FAA-approved aircraft flight manual (AFM) and flight manual supplements. Flight manual supplements will state the level of approach procedure that the receiver supports. IFR approved WAAS receivers support all GPS only operations as long as lateral capability at the appropriate level is functional. WAAS monitors both GPS and WAAS satellites and provides integrity.

3. GPS/WAAS equipment is inherently capable of supporting oceanic and remote operations if the operator obtains a fault detection and exclusion (FDE) prediction program.

4. Air carrier and commercial operators must meet the appropriate provisions of their approved operations specifications.

5. Prior to GPS/WAAS IFR operation, the pilot must review appropriate Notices to Airmen (NOT-AMs) and aeronautical information. This information is available on request from a Flight Service Station. The FAA will provide NOTAMs to advise pilots of the status of the WAAS and level of service available.

(a) The term MAY NOT BE AVBL is used in conjunction with WAAS NOTAMs and indicates that due to ionospheric conditions, lateral guidance may still be available when vertical guidance is unavailable. Under certain conditions, both lateral and vertical guidance may be unavailable. This NOTAM language is an advisory to pilots indicating the expected level of WAAS service (LNAV/VNAV, LPV, LP) may not be available.

EXAMPLE-

!FDC FDC NAV WAAS VNAV/LPV/LP MINIMA MAY NOT BE AVBL 1306111330-1306141930EST

or

!FDC FDC NAV WAAS VNAV/LPV MINIMA NOT AVBL, WAAS LP MINIMA MAY NOT BE AVBL 1306021200-1306031200EST

WAAS MAY NOT BE AVBL NOTAMs are predictive in nature and published for flight planning purposes. Upon commencing an approach at locations NOTAMed WAAS MAY NOT BE AVBL, if the WAAS avionics indicate LNAV/VNAV or LPV service is available, then vertical guidance may be used to complete the approach using the displayed level of service. Should an outage occur during the approach, reversion to LNAV minima or an alternate instrument approach procedure may be required. When GPS testing NOTAMs are published and testing is actually occurring, Air Traffic Control will advise pilots requesting or cleared for a GPS or RNAV (GPS) approach that GPS may not be available and request intentions. If pilots have reported GPS anomalies, Air Traffic Control will request the pilot's intentions and/or clear the pilot for an alternate approach, if available and operational.

(b) WAAS area-wide NOTAMs are originated when WAAS assets are out of service and impact the service area. Area-wide WAAS NOT AVAILABLE (AVBL) NOTAMs indicate loss or malfunction of the WAAS system. In flight, Air

Traffic Control will advise pilots requesting a GPS or RNAV (GPS) approach of WAAS NOT AVBL NOTAMs if not contained in the ATIS broadcast.

EXAMPLE-

For unscheduled loss of signal or service, an example NOTAM is: !FDC FDC NAV WAAS NOT AVBL 1311160600- 1311191200EST.

For scheduled loss of signal or service, an example NOTAM is: !FDC FDC NAV WAAS NOT AVBL 1312041015- 1312082000EST.

(c) Site-specific WAAS MAY NOT BE AVBL NOTAMs indicate an expected level of service; for example, LNAV/VNAV, LP, or LPV may not be available. Pilots must request site-specific WAAS NOTAMs during flight planning. In flight, Air Traffic Control will not advise pilots of WAAS MAY NOT BE AVBL NOTAMs.

NOTE-

Though currently unavailable, the FAA is updating its prediction tool software to provide this site-service in the future.

(d) Most of North America has redundant coverage by two or more geostationary satellites. One exception is the northern slope of Alaska. If there is a problem with the satellite providing coverage to this area, a NOTAM similar to the following example will be issued:

EXAMPLE-

!FDC 4/3406 (PAZA A0173/14) ZAN NAV WAAS SIGNAL MAY NOT BE AVBL NORTH OF LINE FROM 7000N150000W TO 6400N16400W. RMK WAAS USERS SHOULD CONFIRM RAIM AVAILABILITY FOR IFR OPERATIONS IN THIS AREA. T-ROUTES IN THIS SECTOR NOT AVBL. ANY REQUIRED ALTERNATE AIRPORT IN THIS AREA MUST HAVE AN APPROVED INSTRUMENT APPROACH PROCEDURE OTHER THAN GPS THAT IS ANTICIPATED TO BE OPERATIONAL AND AVAILABLE AT THE ESTIMATED TIME OF ARRIVAL AND WHICH THE AIRCRAFT IS EQUIPPED TO FLY. 1406030812-1406050812EST.

6. When GPS-testing NOTAMs are published and testing is actually occurring, Air Traffic Control will advise pilots requesting or cleared for a GPS or RNAV (GPS) approach that GPS may not be available and request intentions. If pilots have reported GPS anomalies, Air Traffic Control will request the pilot's intentions and/or clear the pilot for an alternate approach, if available and operational.

EXAMPLE-

Here is an example of a GPS testing NOTAM:

!GPS 06/001 ZAB NAV GPS (INCLUDING WAAS, GBAS,

AND ADS-B) MAY NOT BE AVAILABLE WITHIN A 468NM RADIUS CENTERED AT 330702N1062540W (TCS 093044) FL400-UNL DECREASING IN AREA WITH A DECREASE IN ALTITUDE DEFINED AS: 425NM RADIUS AT FL250, 360NM RADIUS AT 10000FT, 354NM RADIUS AT 4000FT AGL, 327NM RADIUS AT 50FT AGL. 1406070300-1406071200.

7. When the approach chart is annotated with the **W** symbol, site-specific WAAS MAY NOT BE AVBL NOTAMs or Air Traffic advisories are not provided for outages in WAAS LNAV/VNAV and LPV vertical service. Vertical outages may occur daily at these locations due to being close to the edge of WAAS system coverage. Use LNAV or circling minima for flight planning at these locations, whether as a destination or alternate. For flight operations at these locations, when the WAAS avionics indicate that LNAV/VNAV or LPV service is available, then the vertical guidance may be used to complete the approach using the displayed level of service. Should an outage occur during the procedure, reversion to LNAV minima may be required.

NOTE-

Area-wide WAAS NOT AVBL NOTAMs apply to all airports in the WAAS NOT AVBL area designated in the NOTAM, including approaches at airports where an approach chart is annotated with the **W** symbol.

8. GPS/WAAS was developed to be used within GEO coverage over North America without the need for other radio navigation equipment appropriate to the route of flight to be flown. Outside the WAAS coverage or in the event of a WAAS failure, GPS/WAAS equipment reverts to GPS-only operation and satisfies the requirements for basic GPS equipment. (See paragraph 1-1-17 for these requirements).

9. Unlike TSO-C129 avionics, which were certified as a supplement to other means of navigation, WAAS avionics are evaluated without reliance on other navigation systems. As such, installation of WAAS avionics does not require the aircraft to have other equipment appropriate to the route to be flown. (See paragraph 1-1-17 d for more information on equipment requirements.)

(a) Pilots with WAAS receivers may flight plan to use any instrument approach procedure authorized for use with their WAAS avionics as the planned approach at a required alternate, with the following restrictions. When using WAAS at

an alternate airport, flight planning must be based on flying the RNAV (GPS) LNAV or circling minima line, or minima on a GPS approach procedure, or conventional approach procedure with “or GPS” in the title. Code of Federal Regulation (CFR) Part 91 non-precision weather requirements must be used for planning. Upon arrival at an alternate, when the WAAS navigation system indicates that LNAV/VNAV or LPV service is available, then vertical guidance may be used to complete the approach using the displayed level of service. The FAA has begun removing the **▲ NA** (Alternate Minimums Not Authorized) symbol from select RNAV (GPS) and GPS approach procedures so they may be used by approach approved WAAS receivers at alternate airports. Some approach procedures will still require the **▲ NA** for other reasons, such as no weather reporting, so it cannot be removed from all procedures. Since every procedure must be individually evaluated, removal of the **▲ NA** from RNAV (GPS) and GPS procedures will take some time.

NOTE-

Properly trained and approved, as required, TSO-C145() and TSO-C146() equipped users (WAAS users) with and using approved baro-VNAV equipment may plan for LNAV/VNAV DA at an alternate airport. Specifically authorized WAAS users with and using approved baro-VNAV equipment may also plan for RNP 0.3 DA at the alternate airport as long as the pilot has verified RNP availability through an approved prediction program.

d. Flying Procedures with WAAS

1. WAAS receivers support all basic GPS approach functions and provide additional capabilities. One of the major improvements is the ability to generate glide path guidance, independent of ground equipment or barometric aiding. This eliminates several problems such as hot and cold temperature effects, incorrect altimeter setting, or lack of a local altimeter source. It also allows approach procedures to be built without the cost of installing ground stations at each airport or runway. Some approach certified receivers may only generate a glide path with performance similar to Baro-VNAV and are only approved to fly the LNAV/VNAV line of minima on the RNAV (GPS) approach charts. Receivers with additional capability (including faster update rates and smaller integrity limits) are approved to fly the LPV line of minima. The lateral integrity changes dramatically from the 0.3 NM (556 meter) limit for GPS, LNAV, and LNAV/VNAV approach mode, to

40 meters for LPV. It also provides vertical integrity monitoring, which bounds the vertical error to 50 meters for LNAV/VNAV and LPVs with minima of 250' or above, and bounds the vertical error to 35 meters for LPVs with minima below 250'.

2. When an approach procedure is selected and active, the receiver will notify the pilot of the most accurate level of service supported by the combination of the WAAS signal, the receiver, and the selected approach, using the naming conventions on the minima lines of the selected approach procedure. For example, if an approach is published with LPV minima and the receiver is only certified for LNAV/VNAV, the equipment would indicate "LNAV/VNAV available," even though the WAAS signal would support LPV. If flying an existing LNAV/VNAV procedure with no LPV minima, the receiver will notify the pilot "LNAV/VNAV available," even if the receiver is certified for LPV and the signal supports LPV. If the signal does not support vertical guidance on procedures with LPV and/or LNAV/VNAV minima, the receiver annunciation will read "LNAV available." On lateral only procedures with LP and LNAV minima the receiver will indicate "LP available" or "LNAV available" based on the level of lateral service available. Once the level of service notification has been given, the receiver will operate in this mode for the duration of the approach procedure, unless that level of service becomes unavailable. The receiver cannot change back to a more accurate level of service until the next time an approach is activated.

NOTE-

Receivers do not "fail down" to lower levels of service once the approach has been activated. If only the vertical off flag appears, the pilot may elect to use the LNAV minima if the rules under which the flight is operating allow changing the type of approach being flown after commencing the procedure. If the lateral integrity limit is exceeded on an LP approach, a missed approach will be necessary since there is no way to reset the lateral alarm limit while the approach is active.

3. Another additional feature of WAAS receivers is the ability to exclude a bad GPS signal and continue operating normally. This is normally accomplished by the WAAS correction information. Outside WAAS coverage or when WAAS is not available, it is accomplished through a receiver algorithm called FDE. In most cases this operation will be invisible to the pilot since the receiver will

continue to operate with other available satellites after excluding the "bad" signal. This capability increases the reliability of navigation.

4. Both lateral and vertical scaling for the LNAV/VNAV and LPV approach procedures are different than the linear scaling of basic GPS. When the complete published procedure is flown, ± 1 NM linear scaling is provided until two (2) NM prior to the FAF, where the sensitivity increases to be similar to the angular scaling of an ILS. There are two differences in the WAAS scaling and ILS: 1) on long final approach segments, the initial scaling will be ± 0.3 NM to achieve equivalent performance to GPS (and better than ILS, which is less sensitive far from the runway); 2) close to the runway threshold, the scaling changes to linear instead of continuing to become more sensitive. The width of the final approach course is tailored so that the total width is usually 700 feet at the runway threshold. Since the origin point of the lateral splay for the angular portion of the final is not fixed due to antenna placement like localizer, the splay angle can remain fixed, making a consistent width of final for aircraft being vectored onto the final approach course on different length runways. When the complete published procedure is not flown, and instead the aircraft needs to capture the extended final approach course similar to ILS, the vector to final (VTF) mode is used. Under VTF, the scaling is linear at ± 1 NM until the point where the ILS angular splay reaches a width of ± 1 NM regardless of the distance from the FAWP.

5. The WAAS scaling is also different than GPS TSO-C129() in the initial portion of the missed approach. Two differences occur here. First, the scaling abruptly changes from the approach scaling to the missed approach scaling, at approximately the departure end of the runway or when the pilot selects missed approach guidance rather than ramping as GPS does. Second, when the first leg of the missed approach is a Track to Fix (TF) leg aligned within 3 degrees of the inbound course, the receiver will change to 0.3 NM linear sensitivity until the turn initiation point for the first waypoint in the missed approach procedure, at which time it will abruptly change to terminal (± 1 NM) sensitivity. This allows the elimination of close in obstacles in the early part of the missed approach that may otherwise cause the DA to be raised.

6. There are two ways to select the final approach segment of an instrument approach. Most

receivers use menus where the pilot selects the airport, the runway, the specific approach procedure and finally the IAF, there is also a channel number selection method. The pilot enters a unique 5-digit number provided on the approach chart, and the receiver recalls the matching final approach segment from the aircraft database. A list of information including the available IAFs is displayed and the pilot selects the appropriate IAF. The pilot should confirm that the correct final approach segment was loaded by cross checking the Approach ID, which is also provided on the approach chart.

7. The Along-Track Distance (ATD) during the final approach segment of an LNAV procedure (with a minimum descent altitude) will be to the MAWP. On LNAV/VNAV and LPV approaches to a decision altitude, there is no missed approach waypoint so the along-track distance is displayed to a point normally located at the runway threshold. In most cases, the MAWP for the LNAV approach is located on the runway threshold at the centerline, so these distances will be the same. This distance will always vary slightly from any ILS DME that may be present, since the ILS DME is located further down the runway. Initiation of the missed approach on the LNAV/VNAV and LPV approaches is still based on reaching the decision altitude without any of the items listed in 14 CFR Section 91.175 being visible, and must not be delayed while waiting for the ATD to reach zero. The WAAS receiver, unlike a GPS receiver, will automatically sequence past the MAWP if the missed approach procedure has been designed for RNAV. The pilot may also select missed approach prior to the MAWP; however, navigation will continue to the MAWP prior to waypoint sequencing taking place.

1-1-19. Ground Based Augmentation System (GBAS) Landing System (GLS)

a. General

1. The GLS provides precision navigation guidance for exact alignment and descent of aircraft on approach to a runway. GBAS equipment provides localized differential augmentation to the Global Positioning System (GPS).

NOTE-

To remain consistent with international terminology, the FAA will use the term GBAS in place of the former term Local Area Augmentation System (LAAS).

2. GLS displays three-dimension vertical and horizontal navigation guidance to the pilot much like

ILS. GLS navigation is based on GPS signals augmented by position correction, integrity parameters, and approach path definition information transmitted over VHF from the local GBAS ground station. One GBAS station can support multiple GLS precision approaches to nearby runways within the GBAS's maximum use distance.

3. GLS provides guidance similar to ILS approaches for the final approach segment, though the approach service volume has different dimensions (see FIG 1-1-8). The GLS approach is constructed using the RNP approach (RNP APCH) navigation specification, and may include vertically-guided turn(s) after the IAF or on the missed approach procedure. Portions of the approach prior to an IAF and after the final approach segment may also require Area Navigation (RNAV) typically using the Required Navigation Performance 1 (RNP 1) navigation specification. See paragraph 1-2-1 for more information on navigation specifications.

4. GLS consists of a GBAS Ground Facility (GGF), at least four ground reference stations, a corrections processor, a VHF Data Broadcast (VDB) uplink antenna, an aircraft GBAS receiver, and a charted instrument approach procedure.

b. Procedure

1. Pilots will select the five digit GBAS channel number of the associated GLS approach within the Flight Management System (FMS) menu or manually select the five digits (system dependent). Selection of the GBAS channel number also tunes the VDB.

2. Following procedure selection, confirmation that the correct GLS procedure is loaded can be accomplished by cross checking the charted Reference Path Indicator (RPI) or approach ID with the cockpit displayed RPI or audio identification of the RPI with Morse Code (for some systems). Distance to the runway threshold will be displayed to the pilot once the aircraft is inside the approach service volume.

3. The pilot will fly the GLS approach using many of the same techniques as ILS including using a heading or lateral steering mode to intercept the GLS final approach course and then switching to the appropriate approach navigation mode once the aircraft is within the approach service volume and prior to the glide path intercept point. See also the Instrument Procedures Handbook for more information on GLS.

**FIG 1-1-8
GLS Standard Approach Service Volume**

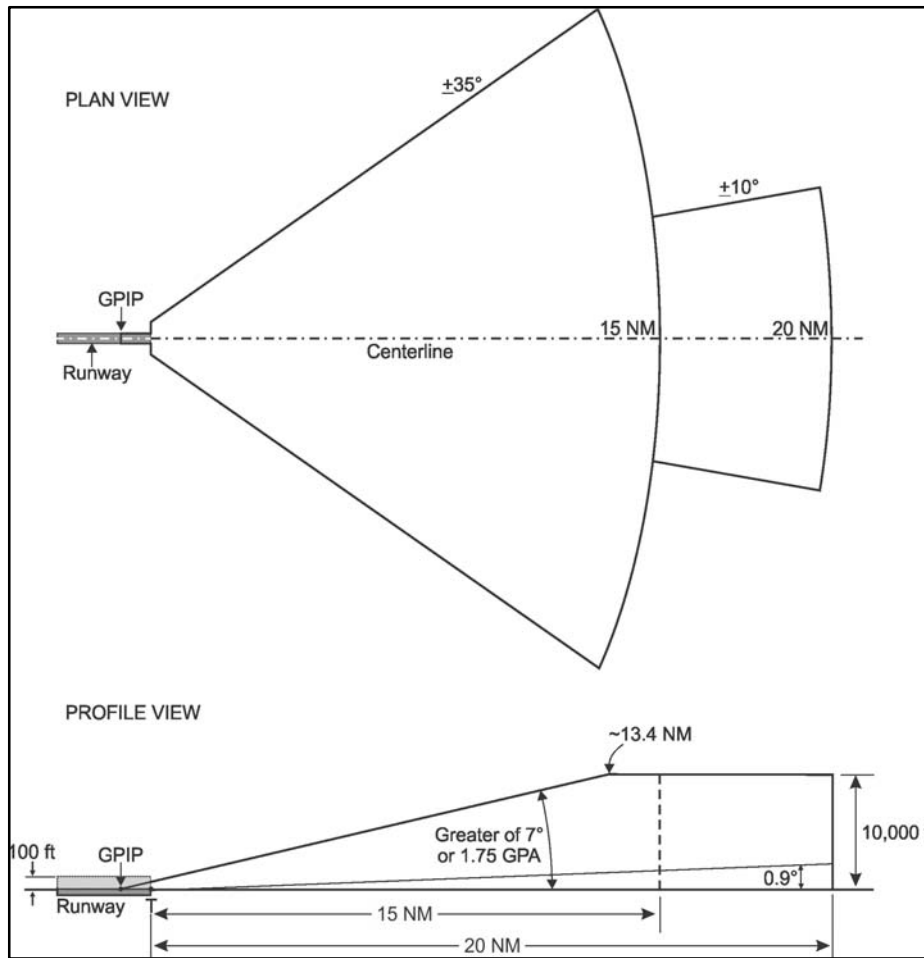

1-1-20. Precision Approach Systems other than ILS and GLS

a. General

Approval and use of precision approach systems other than ILS and GLS require the issuance of special instrument approach procedures.

b. Special Instrument Approach Procedure

1. Special instrument approach procedures must be issued to the aircraft operator if pilot training, aircraft equipment, and/or aircraft performance is different than published procedures. Special instrument approach procedures are not distributed for general public use. These procedures are issued to an aircraft operator when the conditions for operations approval are satisfied.

2. General aviation operators requesting approval for special procedures should contact the local Flight Standards District Office to obtain a letter of authorization. Air carrier operators requesting approval for use of special procedures should contact their Certificate Holding District Office for authorization through their Operations Specification.

c. Transponder Landing System (TLS)

1. The TLS is designed to provide approach guidance utilizing existing airborne ILS localizer, glide slope, and transponder equipment.

2. Ground equipment consists of a transponder interrogator, sensor arrays to detect lateral and vertical position, and ILS frequency transmitters. The TLS detects the aircraft's position by interrogating its transponder. It then broadcasts ILS frequency signals to guide the aircraft along the desired approach path.

3. TLS instrument approach procedures are designated Special Instrument Approach Procedures. Special aircrew training is required. TLS ground equipment provides approach guidance for only one aircraft at a time. Even though the TLS signal is received using the ILS receiver, no fixed course or glidepath is generated. The concept of operation is very similar to an air traffic controller providing radar vectors, and just as with radar vectors, the guidance is valid only for the intended aircraft. The TLS ground equipment tracks one aircraft, based on its transponder code, and provides correction signals to course and glidepath based on the position of the tracked aircraft. Flying the TLS corrections computed for another aircraft will not provide guidance relative to the approach; therefore, aircrews must not use the TLS signal for navigation unless they have received approach clearance and completed the required coordination with the TLS ground equipment operator. Navigation fixes based on conventional NAVAIDs or GPS are provided in the

special instrument approach procedure to allow aircrews to verify the TLS guidance.

d. Special Category I Differential GPS (SCAT-I DGPS)

1. The SCAT-I DGPS is designed to provide approach guidance by broadcasting differential correction to GPS.

2. SCAT-I DGPS procedures require aircraft equipment and pilot training.

3. Ground equipment consists of GPS receivers and a VHF digital radio transmitter. The SCAT-I DGPS detects the position of GPS satellites relative to GPS receiver equipment and broadcasts differential corrections over the VHF digital radio.

4. Category I Ground Based Augmentation System (GBAS) will displace SCAT-I DGPS as the public use service.

REFERENCE-

AIM, Paragraph 5-4-7f, Instrument Approach Procedures

Section 2. Performance-Based Navigation (PBN) and Area Navigation (RNAV)

1-2-1. General

a. Introduction to PBN. As air travel has evolved, methods of navigation have improved to give operators more flexibility. PBN exists under the umbrella of area navigation (RNAV). The term RNAV in this context, as in procedure titles, just means “area navigation,” regardless of the equipment capability of the aircraft. (See FIG 1-2-1.) Many operators have upgraded their systems to obtain the benefits of PBN. Within PBN there are two main categories of navigation methods or specifications: area navigation (RNAV) and required navigation performance (RNP). In this context, the term RNAV *x* means a specific navigation specification with a specified lateral accuracy value. For an aircraft to meet the requirements of PBN, a specified RNAV or RNP accuracy must be met 95 percent of the flight time. RNP is a PBN system that includes onboard

performance monitoring and alerting capability (for example, Receiver Autonomous Integrity Monitoring (RAIM)). PBN also introduces the concept of navigation specifications (NavSpecs) which are a set of aircraft and aircrew requirements needed to support a navigation application within a defined airspace concept. For both RNP and RNAV NavSpecs, the numerical designation refers to the lateral navigation accuracy in nautical miles which is expected to be achieved at least 95 percent of the flight time by the population of aircraft operating within the airspace, route, or procedure. This information is detailed in International Civil Aviation Organization’s (ICAO) Doc 9613, Performance-based Navigation (PBN) Manual and the latest FAA AC 90-105, Approval Guidance for RNP Operations and Barometric Vertical Navigation in the U.S. National Airspace System and in Remote and Oceanic Airspace.

**FIG 1-2-1
Navigation Specifications**

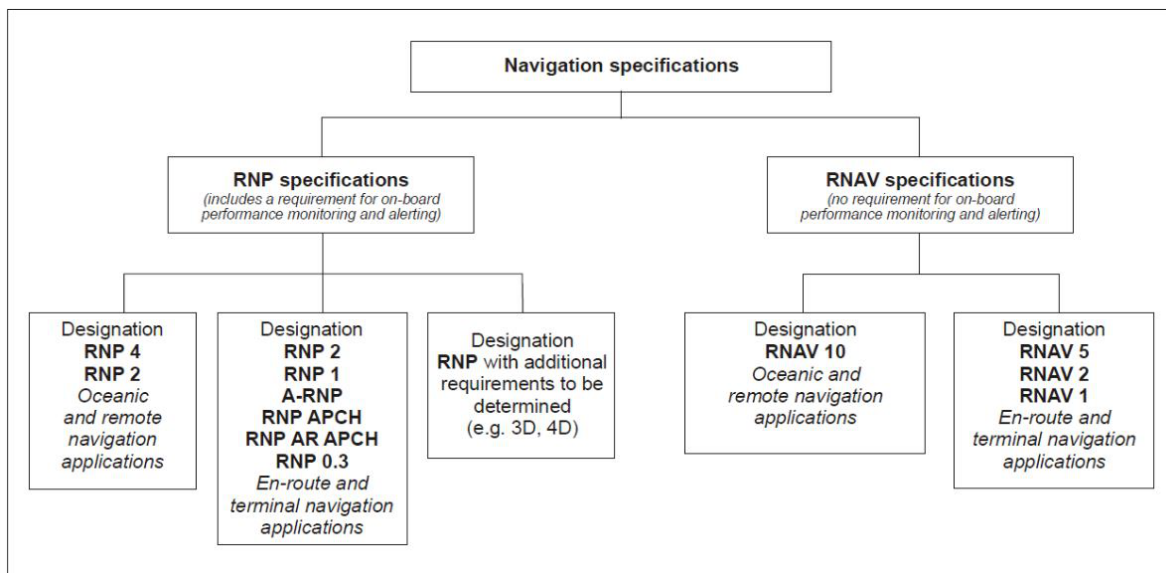

b. Area Navigation (RNAV)

1. General. RNAV is a method of navigation that permits aircraft operation on any desired flight path within the coverage of ground- or space-based navigation aids or within the limits of the capability of self-contained aids, or a combination of these. In the future, there will be an increased dependence on the use of RNAV in lieu of routes defined by ground-based navigation aids. RNAV routes and terminal procedures, including departure procedures (DPs) and standard terminal arrivals (STARs), are designed with RNAV systems in mind. There are several potential advantages of RNAV routes and procedures:

- (a) Time and fuel savings;
- (b) Reduced dependence on radar vectoring, altitude, and speed assignments allowing a reduction in required ATC radio transmissions; and
- (c) More efficient use of airspace.

In addition to information found in this manual, guidance for domestic RNAV DPs, STARs, and routes may also be found in AC 90-100, U.S. Terminal and En Route Area Navigation (RNAV) Operations.

2. RNAV Operations. RNAV procedures, such as DPs and STARs, demand strict pilot awareness and maintenance of the procedure centerline. Pilots should possess a working knowledge of their aircraft navigation system to ensure RNAV procedures are flown in an appropriate manner. In addition, pilots should have an understanding of the various waypoint and leg types used in RNAV procedures; these are discussed in more detail below.

(a) Waypoints. A waypoint is a predetermined geographical position that is defined in terms of latitude/longitude coordinates. Waypoints may be a simple named point in space or associated with existing nav aids, intersections, or fixes. A waypoint is most often used to indicate a change in direction, speed, or altitude along the desired path. RNAV procedures make use of both fly-over and fly-by waypoints.

(1) Fly-by waypoints. Fly-by waypoints are used when an aircraft should begin a turn to the next course prior to reaching the waypoint separating

the two route segments. This is known as turn anticipation.

(2) Fly-over waypoints. Fly-over waypoints are used when the aircraft must fly over the point prior to starting a turn.

NOTE-

FIG 1-2-2 illustrates several differences between a fly-by and a fly-over waypoint.

FIG 1-2-2
Fly-by and Fly-over Waypoints

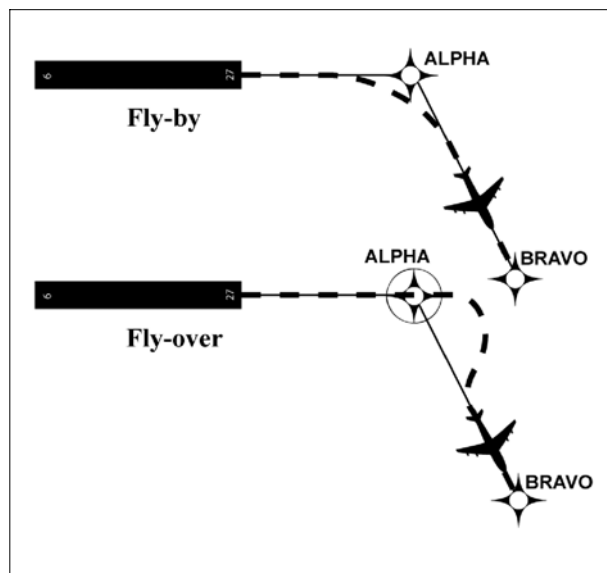

(b) RNAV Leg Types. A leg type describes the desired path proceeding, following, or between waypoints on an RNAV procedure. Leg types are identified by a two-letter code that describes the path (e.g., heading, course, track, etc.) and the termination point (e.g., the path terminates at an altitude, distance, fix, etc.). Leg types used for procedure design are included in the aircraft navigation database, but not normally provided on the procedure chart. The narrative depiction of the RNAV chart describes how a procedure is flown. The “path and terminator concept” defines that every leg of a procedure has a termination point and some kind of path into that termination point. Some of the available leg types are described below.

(1) Track to Fix. A Track to Fix (TF) leg is intercepted and acquired as the flight track to the following waypoint. Track to a Fix legs are sometimes called point-to-point legs for this reason. **Narrative:** “direct ALPHA, then on course to BRAVO WP.” See FIG 1-2-3.

(2) **Direct to Fix.** A Direct to Fix (DF) leg is a path described by an aircraft's track from an initial area direct to the next waypoint. *Narrative:* "turn right direct BRAVO WP." See FIG 1-2-4.

FIG 1-2-3
Track to Fix Leg Type

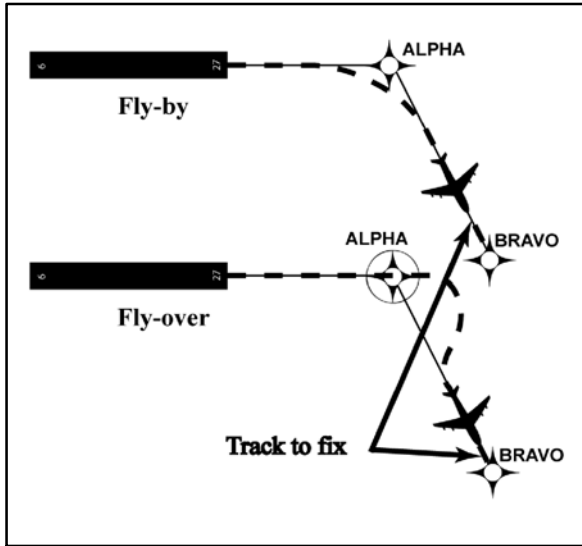
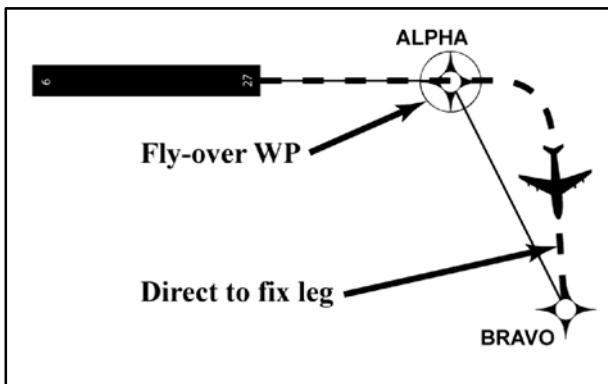
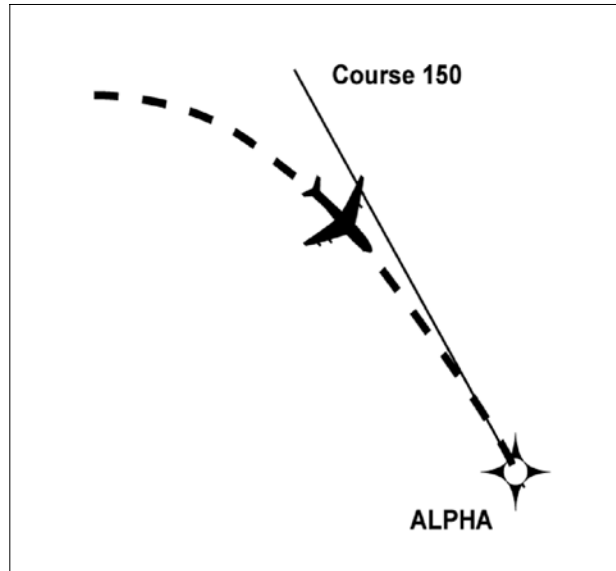

FIG 1-2-4
Direct to Fix Leg Type



(3) **Course to Fix.** A Course to Fix (CF) leg is a path that terminates at a fix with a specified course at that fix. *Narrative:* "on course 150 to ALPHA WP." See FIG 1-2-5.

FIG 1-2-5
Course to Fix Leg Type



(4) **Radius to Fix.** A Radius to Fix (RF) leg is defined as a constant radius circular path around a defined turn center that terminates at a fix. See FIG 1-2-6.

FIG 1-2-6
Radius to Fix Leg Type

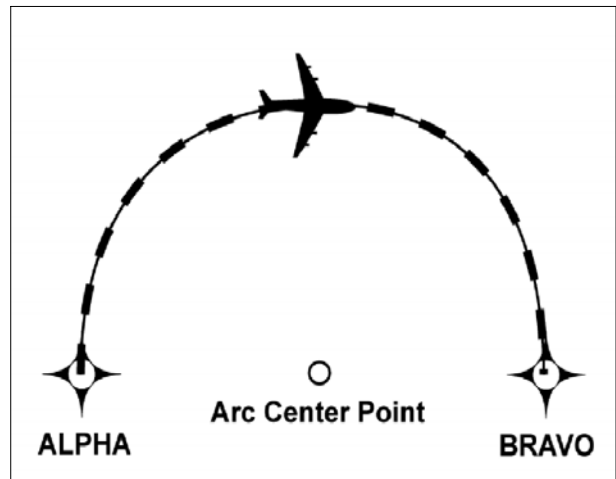

(5) **Heading.** A Heading leg may be defined as, but not limited to, a Heading to Altitude (VA), Heading to DME range (VD), and Heading to Manual Termination, i.e., Vector (VM). *Narrative:* "climb heading 350 to 1500", "heading 265, at 9 DME west of PXR VORTAC, right turn heading 360", "fly heading 090, expect radar vectors to DRYHT INT."

(c) Navigation Issues. Pilots should be aware of their navigation system inputs, alerts, and annunciations in order to make better-informed decisions. In addition, the availability and suitability of particular sensors/systems should be considered.

(1) GPS/WAAS. Operators using TSO-C129(), TSO-C196(), TSO-C145() or TSO-C146() systems should ensure departure and arrival airports are entered to ensure proper RAIM availability and CDI sensitivity.

(2) DME/DME. Operators should be aware that DME/DME position updating is dependent on navigation system logic and DME facility proximity, availability, geometry, and signal masking.

(3) VOR/DME. Unique VOR characteristics may result in less accurate values from VOR/DME position updating than from GPS or DME/DME position updating.

(4) Inertial Navigation. Inertial reference units and inertial navigation systems are often coupled with other types of navigation inputs, e.g., DME/DME or GPS, to improve overall navigation system performance.

NOTE—

Specific inertial position updating requirements may apply.

(d) Flight Management System (FMS). An FMS is an integrated suite of sensors, receivers, and computers, coupled with a navigation database. These systems generally provide performance and RNAV guidance to displays and automatic flight control systems.

Inputs can be accepted from multiple sources such as GPS, DME, VOR, LOC and IRU. These inputs may be applied to a navigation solution one at a time or in combination. Some FMSs provide for the detection and isolation of faulty navigation information.

When appropriate navigation signals are available, FMSs will normally rely on GPS and/or DME/DME (that is, the use of distance information from two or more DME stations) for position updates. Other inputs may also be incorporated based on FMS system architecture and navigation source geometry.

NOTE—

DME/DME inputs coupled with one or more IRU(s) are often abbreviated as DME/DME/IRU or D/D/I.

(e) RNAV Navigation Specifications (Nav Specs)

Nav Specs are a set of aircraft and aircrew requirements needed to support a navigation application within a defined airspace concept. For both RNP and RNAV designations, the numerical designation refers to the lateral navigation accuracy in nautical miles which is expected to be achieved at least 95 percent of the flight time by the population of aircraft operating within the airspace, route, or procedure. (See FIG 1-2-1.)

(1) RNAV 1. Typically RNAV 1 is used for DPs and STARs and appears on the charts. Aircraft must maintain a total system error of not more than 1 NM for 95 percent of the total flight time.

(2) RNAV 2. Typically RNAV 2 is used for en route operations unless otherwise specified. T-routes and Q-routes are examples of this Nav Spec. Aircraft must maintain a total system error of not more than 2 NM for 95 percent of the total flight time.

(3) RNAV 10. Typically RNAV 10 is used in oceanic operations. See paragraph 4-7-1 for specifics and explanation of the relationship between RNP 10 and RNAV 10 terminology.

1-2-2. Required Navigation Performance (RNP)

a. General. While both RNAV navigation specifications (NavSpecs) and RNP NavSpecs contain specific performance requirements, RNP is RNAV with the added requirement for onboard performance monitoring and alerting (OBPMA). RNP is also a statement of navigation performance necessary for operation within a defined airspace. A critical component of RNP is the ability of the aircraft navigation system to monitor its achieved navigation performance, and to identify for the pilot whether the operational requirement is, or is not, being met during an operation. OBPMA capability therefore allows a lessened reliance on air traffic control intervention and/or procedural separation to achieve the overall safety of the operation. RNP capability of the aircraft is a major component in determining the separation criteria to ensure that the overall containment of the operation is met. The RNP capability of an aircraft will vary depending upon the aircraft equipment and the navigation infrastructure. For example, an aircraft may be eligible for RNP 1, but may not be capable of RNP 1 operations due to limited NAVAID coverage

or avionics failure. The Aircraft Flight Manual (AFM) or avionics documents for your aircraft should specifically state the aircraft's RNP eligibilities. Contact the manufacturer of the avionics or the aircraft if this information is missing or incomplete. NavSpecs should be considered different from one another, not "better" or "worse" based on the described lateral navigation accuracy. It is this concept that requires each NavSpec eligibility to be listed separately in the avionics documents or AFM. For example, RNP 1 is different from RNAV 1, and an RNP 1 eligibility does NOT mean automatic RNP 2 or RNAV 1 eligibility. As a safeguard, the FAA requires that aircraft navigation databases hold only those procedures that the aircraft maintains eligibility for. If you look for a specific instrument procedure in your aircraft's navigation database and cannot find it, it's likely that procedure contains PBN elements your aircraft is ineligible for or cannot compute and fly. Further, optional capabilities such as Radius-to-fix (RF) turns or scalability should be described in the AFM or avionics documents. Use the capabilities of your avionics suite to verify the appropriate waypoint and track data after loading the procedure from your database.

b. PBN Operations.

1. Lateral Accuracy Values. Lateral Accuracy values are applicable to a selected airspace, route, or procedure. The lateral accuracy value is a value typically expressed as a distance in nautical miles from the intended centerline of a procedure, route, or path. RNP applications also account for potential errors at some multiple of lateral accuracy value (for example, twice the RNP lateral accuracy values).

(a) RNP NavSpecs. U.S. standard NavSpecs supporting typical RNP airspace uses are as specified below. Other NavSpecs may include different lateral accuracy values as identified by ICAO or other states. (See FIG 1-2-1.)

(1) RNP Approach (RNP APCH). In the U.S., RNP APCH procedures are titled RNAV (GPS) and offer several lines of minima to accommodate varying levels of aircraft equipage: either lateral navigation (LNAV), LNAV/vertical navigation (LNAV/VNAV), Localizer Performance with Vertical Guidance (LPV), and Localizer Performance (LP). GPS with or without Space-Based Augmentation System (SBAS) (for example, WAAS) can provide the lateral information to support LNAV

minima. LNAV/VNAV incorporates LNAV lateral with vertical path guidance for systems and operators capable of either barometric or SBAS vertical. Pilots are required to use SBAS to fly to the LPV or LP minima. RF turn capability is optional in RNP APCH eligibility. This means that your aircraft may be eligible for RNP APCH operations, but you may not fly an RF turn unless RF turns are also specifically listed as a feature of your avionics suite. GBAS Landing System (GLS) procedures are also constructed using RNP APCH NavSpecs and provide precision approach capability. RNP APCH has a lateral accuracy value of 1 in the terminal and missed approach segments and essentially scales to RNP 0.3 (or 40 meters with SBAS) in the final approach. (See Paragraph 5-4-18, RNP AR Instrument Approach Procedures.)

(2) RNP Authorization Required Approach (RNP AR APCH). In the U.S., RNP AR APCH procedures are titled RNAV (RNP). These approaches have stringent equipage and pilot training standards and require special FAA authorization to fly. Scalability and RF turn capabilities are mandatory in RNP AR APCH eligibility. RNP AR APCH vertical navigation performance is based upon barometric VNAV or SBAS. RNP AR is intended to provide specific benefits at specific locations. It is not intended for every operator or aircraft. RNP AR capability requires specific aircraft performance, design, operational processes, training, and specific procedure design criteria to achieve the required target level of safety. RNP AR APCH has lateral accuracy values that can range below 1 in the terminal and missed approach segments and essentially scale to RNP 0.3 or lower in the final approach. Before conducting these procedures, operators should refer to the latest AC 90-101, Approval Guidance for RNP Procedures with AR. (See paragraph 5-4-18.)

(3) RNP Authorization Required Departure (RNP AR DP). Similar to RNP AR approaches, RNP AR departure procedures have stringent equipage and pilot training standards and require special FAA authorization to fly. Scalability and RF turn capabilities is mandatory in RNP AR DP eligibility. RNP AR DP is intended to provide specific benefits at specific locations. It is not intended for every operator or aircraft. RNP AR DP capability requires specific aircraft performance, design, operational processes, training, and specific procedure design criteria to achieve the required

target level of safety. RNP AR DP has lateral accuracy values that can scale to no lower than RNP 0.3 in the initial departure flight path. Before conducting these procedures, operators should refer to the latest AC 90–101, Approval Guidance for RNP Procedures with AR. (See paragraph 5–4–18.)

(4) Advanced RNP (A–RNP). Advanced RNP is a NavSpec with a minimum set of mandatory functions enabled in the aircraft’s avionics suite. In the U.S., these minimum functions include capability to calculate and perform RF turns, scalable RNP, and parallel offset flight path generation. Higher continuity (such as dual systems) may be required for certain oceanic and remote continental airspace. Other “advanced” options for use in the en route environment (such as fixed radius transitions and Time of Arrival Control) are optional in the U.S. Typically, an aircraft eligible for A–RNP will also be eligible for operations comprising: RNP APCH, RNP/RNAV 1, RNP/RNAV 2, RNP 4, and RNP/RNAV 10. A–RNP allows for scalable RNP lateral navigation values (either 1.0 or 0.3) in the terminal environment. Use of these reduced lateral accuracies will normally require use of the aircraft’s autopilot and/or flight director. See the latest AC 90–105 for more information on A–RNP, including NavSpec bundling options, eligibility determinations, and operations approvals.

NOTE–

A–RNP eligible aircraft are NOT automatically eligible for RNP AR APCH or RNP AR DP operations, as RNP AR eligibility requires a separate determination process and special FAA authorization.

(5) RNP 1. RNP 1 requires a lateral accuracy value of 1 for arrival and departure in the terminal area, and the initial and intermediate approach phase when used on conventional procedures with PBN segments (for example, an ILS with a PBN feeder, IAF, or missed approach). RF turn capability is optional in RNP 1 eligibility. This means that your aircraft may be eligible for RNP 1 operations, but you may not fly an RF turn unless RF turns are also specifically listed as a feature of your avionics suite.

(6) RNP 2. RNP 2 will apply to both domestic and oceanic/remote operations with a lateral accuracy value of 2.

(7) RNP 4. RNP 4 will apply to oceanic and remote operations only with a lateral accuracy value

of 4. RNP 4 eligibility will automatically confer RNP 10 eligibility.

(8) RNP 10. The RNP 10 NavSpec applies to certain oceanic and remote operations with a lateral accuracy of 10. In such airspace, the RNAV 10 NavSpec will be applied, so any aircraft eligible for RNP 10 will be deemed eligible for RNAV 10 operations. Further, any aircraft eligible for RNP 4 operations is automatically qualified for RNP 10/RNAV 10 operations. (See also the latest AC 91–70, Oceanic and Remote Continental Airspace Operations, for more information on oceanic RNP/RNAV operations.)

(9) RNP 0.3. The RNP 0.3 NavSpec requires a lateral accuracy value of 0.3 for all authorized phases of flight. RNP 0.3 is not authorized for oceanic, remote, or the final approach segment. Use of RNP 0.3 by slow–flying fixed–wing aircraft is under consideration, but the RNP 0.3 NavSpec initially will apply only to rotorcraft operations. RF turn capability is optional in RNP 0.3 eligibility. This means that your aircraft may be eligible for RNP 0.3 operations, but you may not fly an RF turn unless RF turns are also specifically listed as a feature of your avionics suite.

NOTE–

On terminal procedures or en route charts, do not confuse a charted RNP value of 0.30, or any standard final approach course segment width of 0.30, with the NavSpec title “RNP 0.3.” Charted RNP values of 0.30 or below should contain two decimal places (for example, RNP 0.15, or 0.10, or 0.30) whereas the NavSpec title will only state “RNP 0.3.”

(b) Application of Standard Lateral Accuracy Values. U.S. standard lateral accuracy values typically used for various routes and procedures supporting RNAV operations may be based on use of a specific navigational system or sensor such as GPS, or on multi–sensor RNAV systems having suitable performance.

(c) Depiction of PBN Requirements. In the U.S., PBN requirements like Lateral Accuracy Values or NavSpecs applicable to a procedure will be depicted on affected charts and procedures. In the U.S., a specific procedure’s Performance–Based Navigation (PBN) requirements will be prominently displayed in separate, standardized notes boxes. For procedures with PBN elements, the “PBN box” will contain the procedure’s NavSpec(s); and, if required: specific sensors or infrastructure needed for the

navigation solution, any additional or advanced functional requirements, the minimum RNP value, and any amplifying remarks. Items listed in this PBN box are REQUIRED to fly the procedure’s PBN elements. For example, an ILS with an RNAV missed approach would require a specific capability to fly the missed approach portion of the procedure. That required capability will be listed in the PBN box. The separate Equipment Requirements box will list ground-based equipment and/or airport specific requirements. On procedures with both PBN elements and ground-based equipment requirements, the PBN requirements box will be listed first. (See FIG 5-4-1.)

c. Other RNP Applications Outside the U.S. The FAA and ICAO member states have led initiatives in implementing the RNP concept to oceanic operations. For example, RNP-10 routes

have been established in the northern Pacific (NOPAC) which has increased capacity and efficiency by reducing the distance between tracks to 50 NM. (See paragraph 4-7-1.)

d. Aircraft and Airborne Equipment Eligibility for RNP Operations. Aircraft eligible for RNP operations will have an appropriate entry including special conditions and limitations in its AFM, avionics manual, or a supplement. Operators of aircraft not having specific RNP eligibility statements in the AFM or avionics documents may be issued operational approval including special conditions and limitations for specific RNP eligibilities.

NOTE-
Some airborne systems use Estimated Position Uncertainty (EPU) as a measure of the current estimated navigational performance. EPU may also be referred to as Actual Navigation Performance (ANP) or Estimated Position Error (EPE).

**TBL 1-2-1
 U.S. Standard RNP Levels**

RNP Level	Typical Application	Primary Route Width (NM) – Centerline to Boundary
0.1 to 1.0	RNP AR Approach Segments	0.1 to 1.0
0.3 to 1.0	RNP Approach Segments	0.3 to 1.0
1	Terminal and En Route	1.0
2	En Route	2.0
4	Projected for oceanic/remote areas where 30 NM horizontal separation is applied.	4.0
10	Oceanic/remote areas where 50 NM lateral separation is applied.	10.0

1-2-3. Use of Suitable Area Navigation (RNAV) Systems on Conventional Procedures and Routes

a. Discussion. This paragraph sets forth policy, while providing operational and airworthiness guidance regarding the suitability and use of RNAV systems when operating on, or transitioning to, conventional, non-RNAV routes and procedures within the U.S. National Airspace System (NAS):

1. Use of a suitable RNAV system as a Substitute Means of Navigation when a Very-High Frequency (VHF) Omni-directional Range (VOR),

Distance Measuring Equipment (DME), Tactical Air Navigation (TACAN), VOR/TACAN (VORTAC), VOR/DME, Non-directional Beacon (NDB), or compass locator facility including locator outer marker and locator middle marker is out-of-service (that is, the navigation aid (NAVAID) information is not available); an aircraft is not equipped with an Automatic Direction Finder (ADF) or DME; or the installed ADF or DME on an aircraft is not operational. For example, if equipped with a suitable RNAV system, a pilot may hold over an out-of-service NDB.

2. Use of a suitable RNAV system as an Alternate Means of Navigation when a VOR, DME, VORTAC, VOR/DME, TACAN, NDB, or compass locator facility including locator outer marker and locator middle marker is operational and the respective aircraft is equipped with operational navigation equipment that is compatible with conventional nav aids. For example, if equipped with a suitable RNAV system, a pilot may fly a procedure or route based on operational VOR using that RNAV system without monitoring the VOR.

NOTE—

1. Additional information and associated requirements are available in Advisory Circular 90-108 titled “Use of Suitable RNAV Systems on Conventional Routes and Procedures.”

2. Good planning and knowledge of your RNAV system are critical for safe and successful operations.

3. Pilots planning to use their RNAV system as a substitute means of navigation guidance in lieu of an out-of-service NAVAID may need to advise ATC of this intent and capability.

4. The navigation database should be current for the duration of the flight. If the AIRAC cycle will change during flight, operators and pilots should establish procedures to ensure the accuracy of navigation data, including suitability of navigation facilities used to define the routes and procedures for flight. To facilitate validating database currency, the FAA has developed procedures for publishing the amendment date that instrument approach procedures were last revised. The amendment date follows the amendment number, e.g., Amdt 4 14Jan10. Currency of graphic departure procedures and STARs may be ascertained by the numerical designation in the procedure title. If an amended chart is published for the procedure, or the procedure amendment date shown on the chart is on or after the expiration date of the database, the operator must not use the database to conduct the operation.

b. Types of RNAV Systems that Qualify as a Suitable RNAV System. When installed in accordance with appropriate airworthiness installation requirements and operated in accordance with applicable operational guidance (for example, aircraft flight manual and Advisory Circular material), the following systems qualify as a suitable RNAV system:

1. An RNAV system with TSO-C129/-C145/-C146 equipment, installed in accordance with AC 20-138, Airworthiness Approval of Global Positioning System (GPS) Navigation Equipment for

Use as a VFR and IFR Supplemental Navigation System, and authorized for instrument flight rules (IFR) en route and terminal operations (including those systems previously qualified for “GPS in lieu of ADF or DME” operations), or

2. An RNAV system with DME/DME/IRU inputs that is compliant with the equipment provisions of AC 90-100A, U.S. Terminal and En Route Area Navigation (RNAV) Operations, for RNAV routes. A table of compliant equipment is available at the following website:

https://www.faa.gov/about/office_org/headquarters_offices/avs/offices/afx/afs/afs400/afs410/media/AC90-100compliance.pdf

NOTE—

Approved RNAV systems using DME/DME/IRU, without GPS/WAAS position input, may only be used as a substitute means of navigation when specifically authorized by a Notice to Airmen (NOTAM) or other FAA guidance for a specific procedure. The NOTAM or other FAA guidance authorizing the use of DME/DME/IRU systems will also identify any required DME facilities based on an FAA assessment of the DME navigation infrastructure.

c. Uses of Suitable RNAV Systems. Subject to the operating requirements, operators may use a suitable RNAV system in the following ways.

1. Determine aircraft position relative to, or distance from a VOR (see NOTE 6 below), TACAN, NDB, compass locator, DME fix; or a named fix defined by a VOR radial, TACAN course, NDB bearing, or compass locator bearing intersecting a VOR or localizer course.

2. Navigate to or from a VOR, TACAN, NDB, or compass locator.

3. Hold over a VOR, TACAN, NDB, compass locator, or DME fix.

4. Fly an arc based upon DME.

NOTE—

1. The allowances described in this section apply even when a facility is identified as required on a procedure (for example, “Note ADF required”).

2. These operations do not include lateral navigation on localizer-based courses (including localizer back-course guidance) without reference to raw localizer data.

3. Unless otherwise specified, a suitable RNAV system cannot be used for navigation on procedures that are identified as not authorized (“NA”) without exception by a NOTAM. For example, an operator may not use a RNAV system to navigate on a procedure affected by an expired or

unsatisfactory flight inspection, or a procedure that is based upon a recently decommissioned NAVAID.

4. *Pilots may not substitute for the NAVAID (for example, a VOR or NDB) providing lateral guidance for the final approach segment. This restriction does not refer to instrument approach procedures with “or GPS” in the title when using GPS or WAAS. These allowances do not apply to procedures that are identified as not authorized (NA) without exception by a NOTAM, as other conditions may still exist and result in a procedure not being available. For example, these allowances do not apply to a procedure associated with an expired or unsatisfactory flight inspection, or is based upon a recently decommissioned NAVAID.*

5. *Use of a suitable RNAV system as a means to navigate on the final approach segment of an instrument approach procedure based on a VOR, TACAN or NDB signal, is allowable. The underlying NAVAID must be operational and the NAVAID monitored for final segment course alignment.*

6. *For the purpose of paragraph c, “VOR” includes VOR, VOR/DME, and VORTAC facilities and “compass locator” includes locator outer marker and locator middle marker.*

d. Alternate Airport Considerations. For the purposes of flight planning, any required alternate airport must have an available instrument approach procedure that does not require the use of GPS. This restriction includes conducting a conventional approach at the alternate airport using a substitute means of navigation that is based upon the use of GPS. For example, these restrictions would apply when planning to use GPS equipment as a substitute means of navigation for an out-of-service VOR that supports an ILS missed approach procedure at an alternate airport. In this case, some other approach not reliant upon the use of GPS must be available. This restriction does not apply to RNAV systems using TSO-C145/-C146 WAAS equipment. For further WAAS guidance, see paragraph 1-1-18.

1. For flight planning purposes, TSO-C129() and TSO-C196() equipped users (GPS users) whose navigation systems have fault detection and exclusion (FDE) capability, who perform a preflight RAIM prediction at the airport where the RNAV (GPS) approach will be flown, and have proper knowledge and any required training and/or approval to conduct a GPS-based IAP, may file based on a GPS-based IAP at either the destination or the alternate airport, but not at both locations. At the

alternate airport, pilots may plan for applicable alternate airport weather minimums using:

(a) Lateral navigation (LNAV) or circling minimum descent altitude (MDA);

(b) LNAV/vertical navigation (LNAV/VNAV) DA, if equipped with and using approved barometric vertical navigation (baro-VNAV) equipment;

(c) RNP 0.3 DA on an RNAV (RNP) IAP, if they are specifically authorized users using approved baro-VNAV equipment and the pilot has verified required navigation performance (RNP) availability through an approved prediction program.

2. If the above conditions cannot be met, any required alternate airport must have an approved instrument approach procedure other than GPS that is anticipated to be operational and available at the estimated time of arrival, and which the aircraft is equipped to fly.

3. This restriction does not apply to TSO-C145() and TSO-C146() equipped users (WAAS users). For further WAAS guidance, see paragraph 1-1-18.

1-2-4. Pilots and Air Traffic Controllers Recognizing Interference or Spoofing

a. Pilots need to maintain position awareness while navigating. This awareness may be facilitated by keeping relevant ground-based, legacy navigational aids tuned and available. By utilizing this practice, situational awareness is promoted and guards against significant pilot delay in recognizing the onset of GPS interference. Pilots may find cross-checks of other airborne systems (for example, DME/DME/IRU or VOR) useful to mitigate this otherwise undetected hazard.

REFERENCE-

AIM Paragraph 1-1-17, Global Positioning System (GPS)

AIM Paragraph 1-1-18, Wide Area Augmentation System (WAAS)

b. During preflight planning, pilots should be particularly alert for NOTAMs which could affect navigation (GPS or WAAS) along their route of flight, such as Department of Defense electronic signal tests with GPS.

REFERENCE-

AIM Paragraph 1-1-17, Global Positioning System (GPS)

AIM Paragraph 1-1-18, Wide Area Augmentation System (WAAS)

c. If the pilot experiences interruptions while navigating with GPS, the pilot and ATC may both

incur a higher workload. In the aircraft, the pilot may need to change to a position determining method that does not require GPS-derived signals (for example, DME/DME/IRU or VOR). If transitioning to VOR navigation, the pilot should refer to the current Chart Supplement U.S. to identify airports with available conventional approaches associated with the VOR Minimum Operational Network (MON) program. If the pilot's aircraft is under ATC radar or multilateration surveillance, ATC may be able to provide radar vectors out of the interference affected area or to an alternate destination upon pilot request. An ADS-B Out aircraft's broadcast information may be incorrect and should not be relied upon for surveillance when interference or spoofing is suspected unless its accuracy can be verified by independent means. During the approach phase, a pilot might elect to continue in visual conditions or may need to execute

the published missed approach. If the published missed approach procedure is GPS-based, the pilot will need alternate instructions. If the pilot were to choose to continue in visual conditions, the pilot could aid the controller by cancelling his/her IFR flight plan and proceeding visually to the airport to land. ATC would cancel the pilot's IFR clearance and issue a VFR squawk; freeing up the controller to handle other aircraft.

d. The FAA requests that pilots notify ATC if they experience interruptions to their GPS navigation or surveillance. GPS interference or outages associated with a known testing NOTAM should not be reported to ATC unless the interference/outage affects the pilot's ability to navigate his/her aircraft.

REFERENCE-

AIM Paragraph 1-1-13, User Reports Requested on NAVAID or Global Navigation Satellite System (GNSS) Performance or Interference.

Chapter 2. Aeronautical Lighting and Other Airport Visual Aids

Section 1. Airport Lighting Aids

2-1-1. Approach Light Systems (ALS)

a. ALS provide the basic means to transition from instrument flight to visual flight for landing. Operational requirements dictate the sophistication and configuration of the approach light system for a particular runway.

b. ALS are a configuration of signal lights starting at the landing threshold and extending into the approach area a distance of 2400–3000 feet for precision instrument runways and 1400–1500 feet for nonprecision instrument runways. Some systems include sequenced flashing lights which appear to the pilot as a ball of light traveling towards the runway at high speed (twice a second). (See FIG 2-1-1.)

2-1-2. Visual Glideslope Indicators

a. Visual Approach Slope Indicator (VASI)

1. VASI installations may consist of either 2, 4, 6, 12, or 16 light units arranged in bars referred to as near, middle, and far bars. Most VASI installations consist of 2 bars, near and far, and may consist of 2, 4, or 12 light units. Some VASIs consist of three bars, near, middle, and far, which provide an additional visual glide path to accommodate high cockpit aircraft. This installation may consist of either 6 or 16 light units. VASI installations consisting of 2, 4, or 6 light units are located on one side of the runway, usually the left. Where the installation consists of 12 or 16 light units, the units are located on both sides of the runway.

2. Two-bar VASI installations provide one visual glide path which is normally set at 3 degrees. Three-bar VASI installations provide two visual glide paths. The lower glide path is provided by the near and middle bars and is normally set at 3 degrees

while the upper glide path, provided by the middle and far bars, is normally $1/4$ degree higher. This higher glide path is intended for use only by high cockpit aircraft to provide a sufficient threshold crossing height. Although normal glide path angles are three degrees, angles at some locations may be as high as 4.5 degrees to give proper obstacle clearance. Pilots of high performance aircraft are cautioned that use of VASI angles in excess of 3.5 degrees may cause an increase in runway length required for landing and rollout.

3. The basic principle of the VASI is that of color differentiation between red and white. Each light unit projects a beam of light having a white segment in the upper part of the beam and red segment in the lower part of the beam. The light units are arranged so that the pilot using the VASIs during an approach will see the combination of lights shown below.

4. The VASI is a system of lights so arranged to provide visual descent guidance information during the approach to a runway. These lights are visible from 3–5 miles during the day and up to 20 miles or more at night. The visual glide path of the VASI provides safe obstruction clearance within plus or minus 10 degrees of the extended runway centerline and to 4 NM from the runway threshold. Descent, using the VASI, should not be initiated until the aircraft is visually aligned with the runway. Lateral course guidance is provided by the runway or runway lights. In certain circumstances, the safe obstruction clearance area may be reduced by narrowing the beam width or shortening the usable distance due to local limitations, or the VASI may be offset from the extended runway centerline. This will be noted in the Chart Supplement U.S. and/or applicable notices to airmen (NOTAM).

FIG 2-1-1
Precision & Nonprecision Configurations

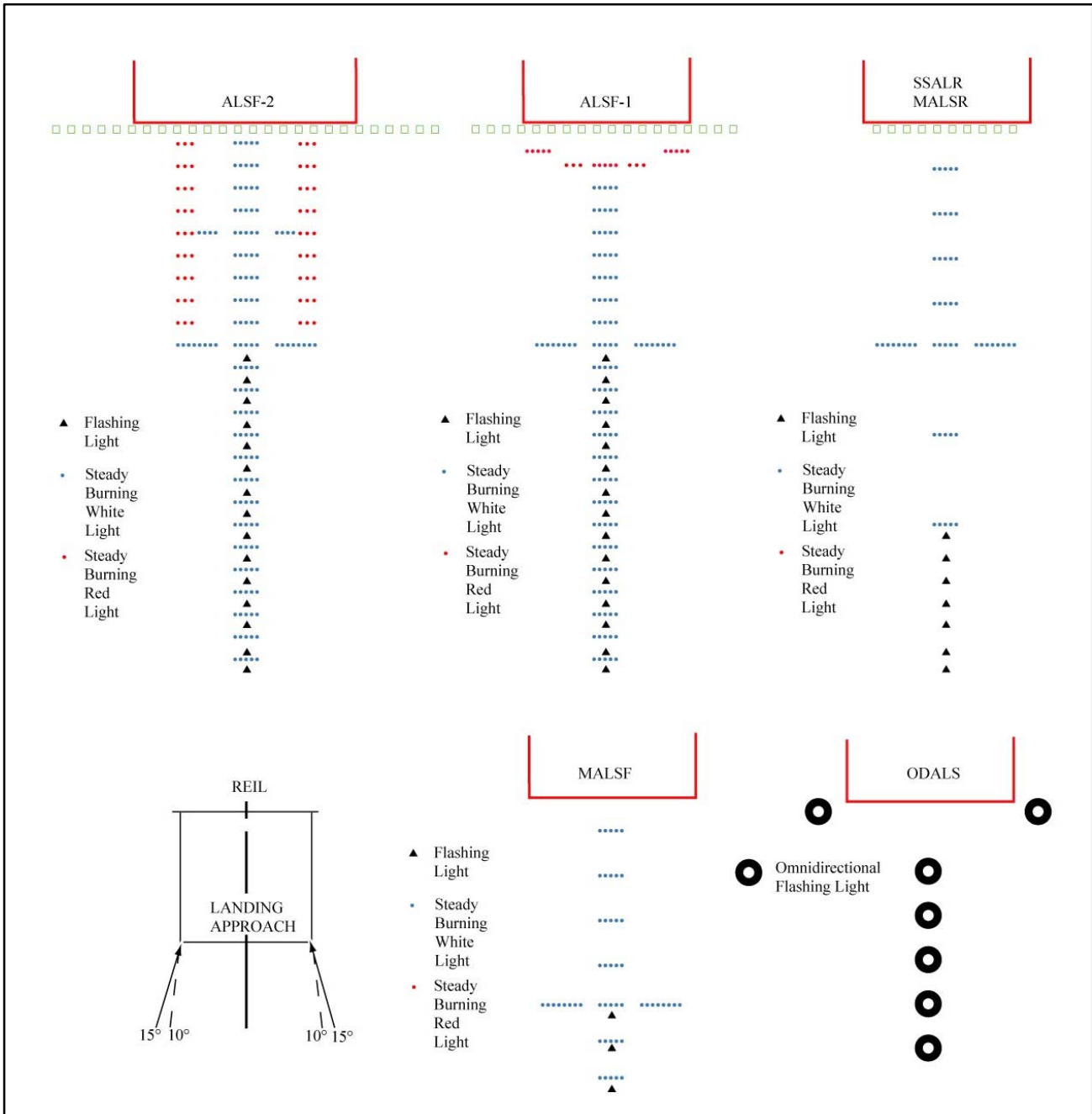

NOTE-
Civil ALSF-2 may be operated as SSALR during favorable weather conditions.

5. For 2-bar VASI (4 light units) see FIG 2-1-2.

**FIG 2-1-2
2-Bar VASI**

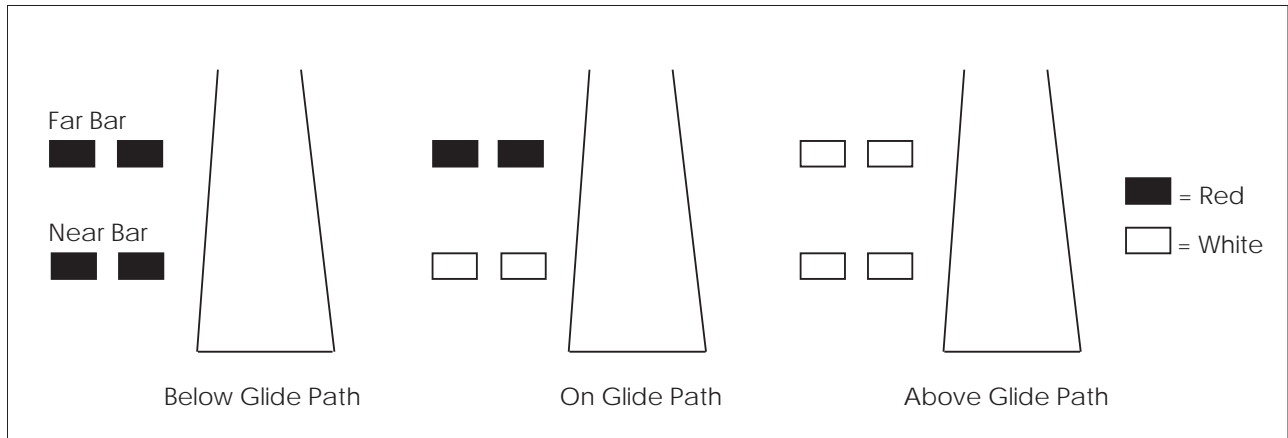

6. For 3-bar VASI (6 light units) see FIG 2-1-3.

**FIG 2-1-3
3-Bar VASI**

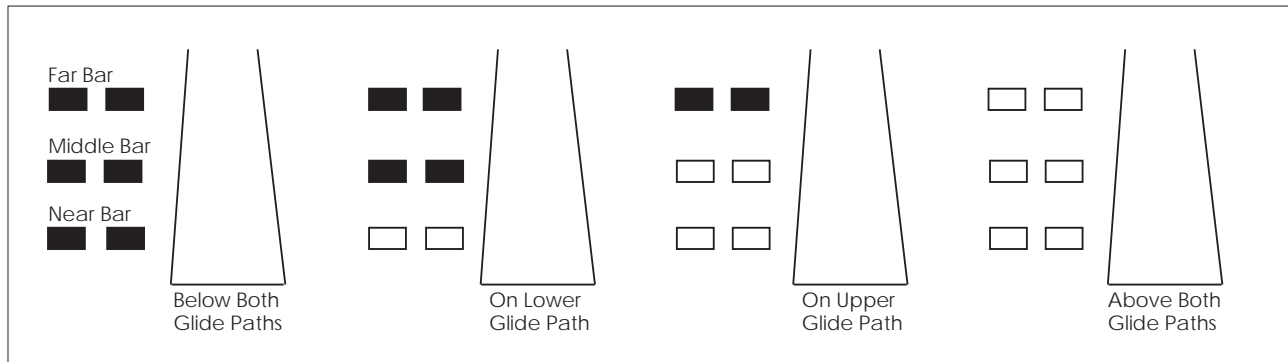

7. For other VASI configurations see FIG 2-1-4.

**FIG 2-1-4
VASI Variations**

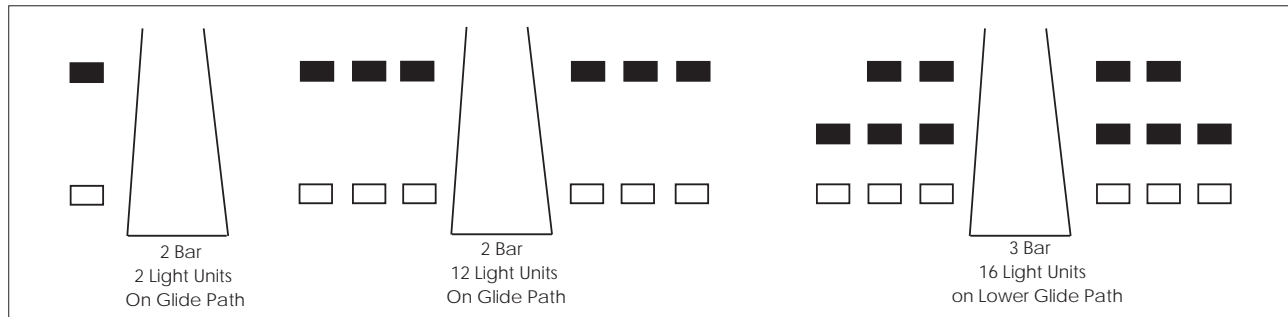

b. Precision Approach Path Indicator (PAPI). The precision approach path indicator (PAPI) uses light units similar to the VASI but are installed in a single row of either two or four light units. These lights are visible from about 5 miles during the day and up to 20 miles at night. The visual glide path of the PAPI typically provides safe obstruction clearance within plus or minus 10 degrees of the extended runway centerline and to 3.4 NM from the runway threshold. Descent, using the PAPI, should not be initiated until the aircraft is visually aligned

with the runway. The row of light units is normally installed on the left side of the runway and the glide path indications are as depicted. Lateral course guidance is provided by the runway or runway lights. In certain circumstances, the safe obstruction clearance area may be reduced by narrowing the beam width or shortening the usable distance due to local limitations, or the PAPI may be offset from the extended runway centerline. This will be noted in the Chart Supplement U.S. and/or applicable NOTAMs. (See FIG 2-1-5.)

**FIG 2-1-5
Precision Approach Path Indicator (PAPI)**

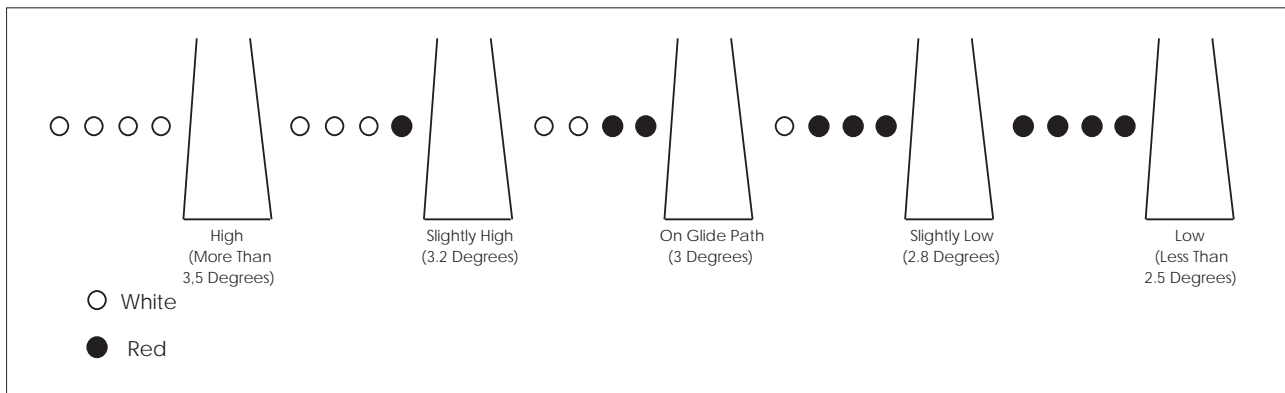

c. Tri-color Systems. Tri-color visual approach slope indicators normally consist of a single light unit projecting a three-color visual approach path into the final approach area of the runway upon which the indicator is installed. The below glide path indication is red, the above glide path indication is amber, and

the on glide path indication is green. These types of indicators have a useful range of approximately one-half to one mile during the day and up to five miles at night depending upon the visibility conditions. (See FIG 2-1-6.)

**FIG 2-1-6
Tri-Color Visual Approach Slope Indicator**

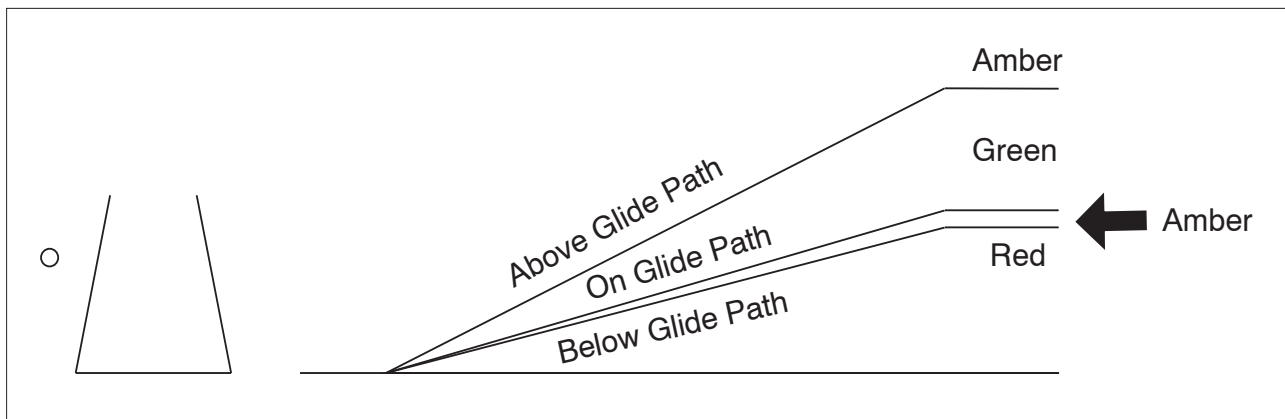

NOTE-

1. Since the tri-color VASI consists of a single light source which could possibly be confused with other light sources, pilots should exercise care to properly locate and identify the light signal.

2. When the aircraft descends from green to red, the pilot may see a dark amber color during the transition from green to red.

FIG 2-1-7
Pulsating Visual Approach Slope Indicator

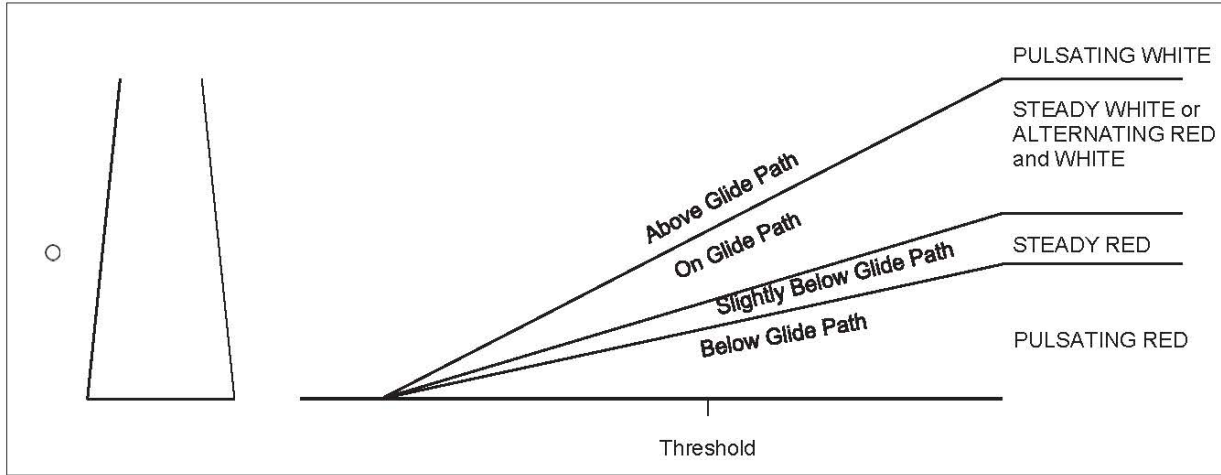

NOTE-

Since the PVASI consists of a single light source which could possibly be confused with other light sources, pilots should exercise care to properly locate and identify the light signal.

FIG 2-1-8
Alignment of Elements

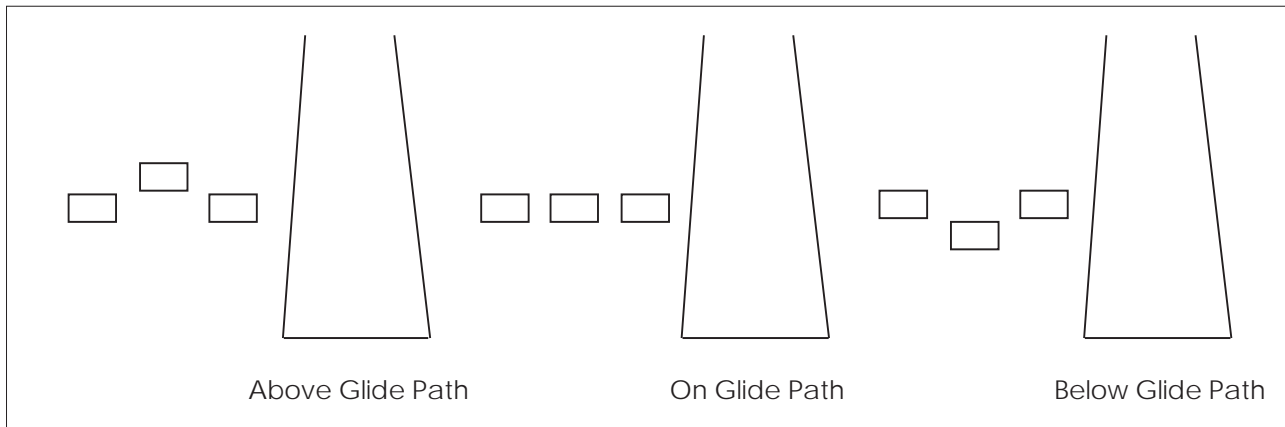

d. Pulsating Systems. Pulsating visual approach slope indicators normally consist of a single light unit projecting a two-color visual approach path into the final approach area of the runway upon which the indicator is installed. The on glide path indication may be a steady white light or alternating RED and WHITE light. The slightly below glide path indication is a steady red light. If the aircraft descends further below the glide path, the red light starts to pulsate. The above glide path indication is a pulsating white light. The pulsating rate increases as the aircraft

gets further above or below the desired glide slope. The useful range of the system is about four miles during the day and up to ten miles at night. (See FIG 2-1-7.)

e. Alignment of Elements Systems. Alignment of elements systems are installed on some small general aviation airports and are a low-cost system consisting of painted plywood panels, normally black and white or fluorescent orange. Some of these systems are lighted for night use. The useful range of

these systems is approximately three-quarter miles. To use the system the pilot positions the aircraft so the elements are in alignment. The glide path indications are shown in FIG 2-1-8.

2-1-3. Runway End Identifier Lights (REIL)

REILs are installed at many airfields to provide rapid and positive identification of the approach end of a particular runway. The system consists of a pair of synchronized flashing lights located laterally on each side of the runway threshold. REILs may be either omnidirectional or unidirectional facing the approach area. They are effective for:

- a. Identification of a runway surrounded by a preponderance of other lighting.
- b. Identification of a runway which lacks contrast with surrounding terrain.
- c. Identification of a runway during reduced visibility.

2-1-4. Runway Edge Light Systems

a. Runway edge lights are used to outline the edges of runways during periods of darkness or restricted visibility conditions. These light systems are classified according to the intensity or brightness they are capable of producing: they are the High Intensity Runway Lights (HIRL), Medium Intensity Runway Lights (MIRL), and the Low Intensity Runway Lights (LIRL). The HIRL and MIRL systems have variable intensity controls, whereas the LIRLs normally have one intensity setting.

b. The runway edge lights are white, except on instrument runways yellow replaces white on the last 2,000 feet or half the runway length, whichever is less, to form a caution zone for landings.

c. The lights marking the ends of the runway emit red light toward the runway to indicate the end of runway to a departing aircraft and emit green outward from the runway end to indicate the threshold to landing aircraft.

2-1-5. In-runway Lighting

a. **Runway Centerline Lighting System (RCLS).** Runway centerline lights are installed on some precision approach runways to facilitate landing under adverse visibility conditions. They are located along the runway centerline and are spaced at 50-foot intervals. When viewed from the landing

threshold, the runway centerline lights are white until the last 3,000 feet of the runway. The white lights begin to alternate with red for the next 2,000 feet, and for the last 1,000 feet of the runway, all centerline lights are red.

b. **Touchdown Zone Lights (TDZL).** Touchdown zone lights are installed on some precision approach runways to indicate the touchdown zone when landing under adverse visibility conditions. They consist of two rows of transverse light bars disposed symmetrically about the runway centerline. The system consists of steady-burning white lights which start 100 feet beyond the landing threshold and extend to 3,000 feet beyond the landing threshold or to the midpoint of the runway, whichever is less.

c. **Taxiway Centerline Lead-Off Lights.** Taxiway centerline lead-off lights provide visual guidance to persons exiting the runway. They are color-coded to warn pilots and vehicle drivers that they are within the runway environment or instrument landing system (ILS) critical area, whichever is more restrictive. Alternate green and yellow lights are installed, beginning with green, from the runway centerline to one centerline light position beyond the runway holding position or ILS critical area holding position.

d. **Taxiway Centerline Lead-On Lights.** Taxiway centerline lead-on lights provide visual guidance to persons entering the runway. These "lead-on" lights are also color-coded with the same color pattern as lead-off lights to warn pilots and vehicle drivers that they are within the runway environment or instrument landing system (ILS) critical area, whichever is more conservative. The fixtures used for lead-on lights are bidirectional, i.e., one side emits light for the lead-on function while the other side emits light for the lead-off function. Any fixture that emits yellow light for the lead-off function must also emit yellow light for the lead-on function. (See FIG 2-1-14.)

e. **Land and Hold Short Lights.** Land and hold short lights are used to indicate the hold short point on certain runways which are approved for Land and Hold Short Operations (LAHSO). Land and hold short lights consist of a row of pulsing white lights installed across the runway at the hold short point. Where installed, the lights will be on anytime LAHSO is in effect. These lights will be off when LAHSO is not in effect.

REFERENCE-

AIM, Paragraph 4-3-11, Pilot Responsibilities When Conducting Land and Hold Short Operations (LAHSO)

2-1-6. Runway Status Light (RWSL) System

a. Introduction.

RWSL is a fully automated system that provides runway status information to pilots and surface vehicle operators to clearly indicate when it is unsafe to enter, cross, takeoff from, or land on a runway. The RWSL system processes information from surveillance systems and activates Runway Entrance Lights (REL), Takeoff Hold Lights (THL), Runway Intersection Lights (RIL), and Final Approach Runway Occupancy Signal (FAROS) in accordance with the position and velocity of the detected surface traffic and approach traffic. REL, THL, and RIL are in-pavement light fixtures that are directly visible to pilots and surface vehicle operators. FAROS alerts arriving pilots that the approaching runway is occupied by flashing the Precision Approach Path Indicator (PAPI). FAROS may be implemented as an add-on to the RWSL system or implemented as a stand-alone system at airports without a RWSL system. RWSL is an independent safety enhancement that does not substitute for or convey an ATC clearance. Clearance to enter, cross, takeoff from, land on, or operate on a runway must still be received from ATC. Although ATC has limited control over the system, personnel do not directly use and may not be able to view light fixture activations and deactivations during the conduct of daily ATC operations.

b. Runway Entrance Lights (REL): The REL system is composed of flush mounted, in-pavement, unidirectional light fixtures that are parallel to and focused along the taxiway centerline and directed toward the pilot at the hold line. An array of REL lights include the first light at the hold line followed by a series of evenly spaced lights to the runway edge; one additional light at the runway centerline is in line with the last two lights before the runway edge (see FIG 2-1-9 and FIG 2-1-12). When activated, the red lights indicate that there is high speed traffic on the runway or there is an aircraft on final approach within the activation area.

1. REL Operating Characteristics – Departing Aircraft:

When a departing aircraft reaches a site adaptable speed of approximately 30 knots, all taxiway intersections with REL arrays along the runway ahead of the aircraft will illuminate (see FIG 2-1-9). As the aircraft approaches an REL equipped taxiway intersection, the lights at that intersection extinguish approximately 3 to 4 seconds before the aircraft reaches it. This allows controllers to apply “anticipated separation” to permit ATC to move traffic more expeditiously without compromising safety. After the aircraft is declared “airborne” by the system, all REL lights associated with this runway will extinguish.

2. REL Operating Characteristics – Arriving Aircraft:

When an aircraft on final approach is approximately 1 mile from the runway threshold, all sets of taxiway REL light arrays that intersect the runway illuminate. The distance is adjustable and can be configured for specific operations at particular airports. Lights extinguish at each equipped taxiway intersection approximately 3 to 4 seconds before the aircraft reaches it to apply anticipated separation until the aircraft has slowed to approximately 80 knots (site adjustable parameter). Below 80 knots, all arrays that are not within 30 seconds of the aircraft’s forward path are extinguished. Once the arriving aircraft slows to approximately 34 knots (site adjustable parameter), it is declared to be in a taxi state, and all lights extinguish.

3. What a pilot would observe: A pilot at or approaching the hold line to a runway will observe RELs illuminate and extinguish in reaction to an aircraft or vehicle operating on the runway, or an arriving aircraft operating less than 1 mile from the runway threshold.

4. When a pilot observes the red lights of the REL, that pilot will stop at the hold line or remain stopped. The pilot will then contact ATC for resolution if the clearance is in conflict with the lights. Should pilots note illuminated lights under circumstances when remaining clear of the runway is impractical for safety reasons (for example, aircraft is already on the runway), the crew should proceed according to their best judgment while understanding the illuminated lights indicate the runway is unsafe to enter or cross. Contact ATC at the earliest possible opportunity.

FIG 2-1-9
Runway Status Light System

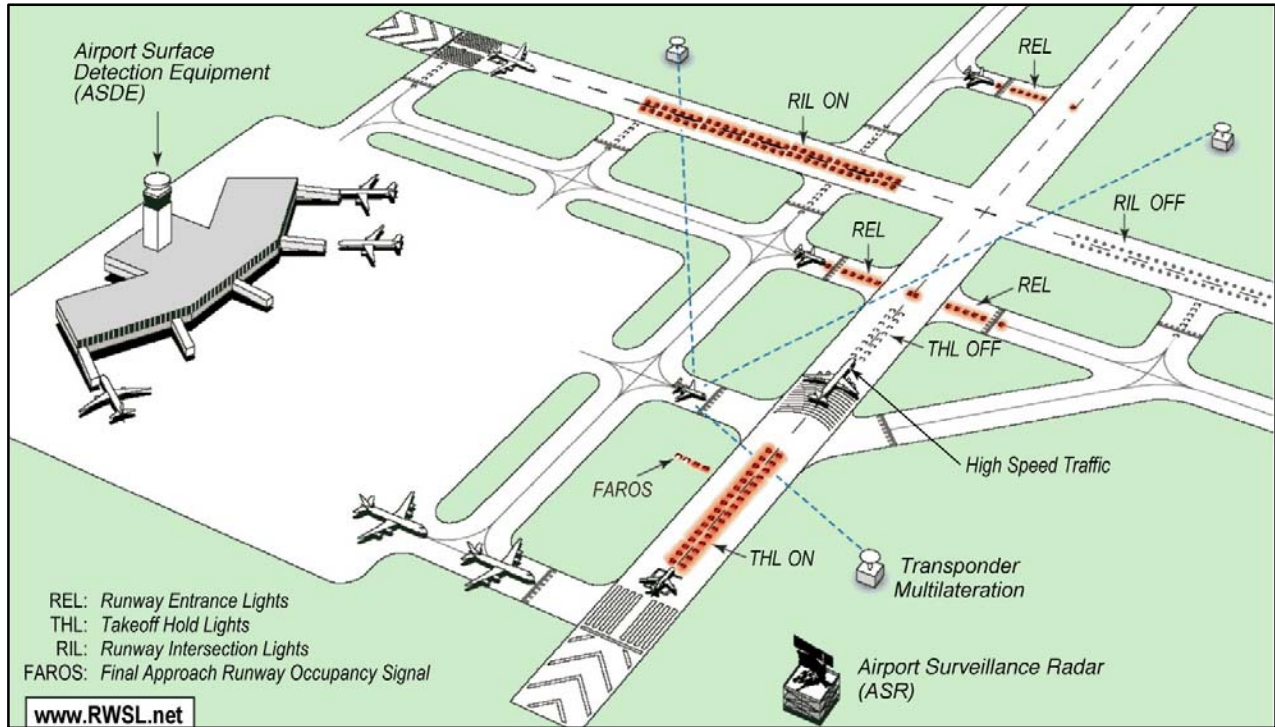

c. Takeoff Hold Lights (THL) : The THL system is composed of flush mounted, in-pavement, unidirectional light fixtures in a double longitudinal row aligned either side of the runway centerline lighting. Fixtures are focused toward the arrival end of the runway at the “line up and wait” point. THLs extend for 1,500 feet in front of the holding aircraft starting at a point 375 feet from the departure threshold (see FIG 2-1-13). Illuminated red lights provide a signal, to an aircraft in position for takeoff or rolling, that it is unsafe to takeoff because the runway is occupied or about to be occupied by another aircraft or ground vehicle. Two aircraft, or a surface vehicle and an aircraft, are required for the lights to illuminate. The departing aircraft must be in position for takeoff or beginning takeoff roll. Another aircraft or a surface vehicle must be on or about to cross the runway.

1. THL Operating Characteristics – Departing Aircraft:

THLs will illuminate for an aircraft in position for departure or departing when there is another aircraft or vehicle on the runway or about to enter the runway (see FIG 2-1-9.) Once that aircraft or vehicle exits the runway, the THLs extinguish. A pilot may notice

lights extinguish prior to the downfield aircraft or vehicle being completely clear of the runway but still moving. Like RELs, THLs have an “anticipated separation” feature.

NOTE–
When the THLs extinguish, this is not clearance to begin a takeoff roll. All takeoff clearances will be issued by ATC.

2. What a pilot would observe: A pilot in position to depart from a runway, or has begun takeoff roll, will observe THLs illuminate in reaction to an aircraft or vehicle on the runway or entering or crossing it. Lights will extinguish when the runway is clear. A pilot may observe several cycles of illumination and extinguishing depending on the amount of crossing traffic.

3. When a pilot observes the red light of the THLs, the pilot should safely stop if it’s feasible or remain stopped. The pilot must contact ATC for resolution if any clearance is in conflict with the lights. Should pilots note illuminated lights while in takeoff roll and under circumstances when stopping is impractical for safety reasons, the crew should proceed according to their best judgment while understanding the illuminated lights indicate that

continuing the takeoff is unsafe. Contact ATC at the earliest possible opportunity.

d. Runway Intersection Lights (RIL): The RIL system is composed of flush mounted, in-pavement, unidirectional light fixtures in a double longitudinal row aligned either side of the runway centerline lighting in the same manner as THLs. Their appearance to a pilot is similar to that of THLs. Fixtures are focused toward the arrival end of the runway, and they extend for 3,000 feet in front of an aircraft that is approaching an intersecting runway. They end at the Land and Hold Short Operation (LASHO) light bar or the hold short line for the intersecting runway.

1. RIL Operating Characteristics – Departing Aircraft:

RILs will illuminate for an aircraft departing or in position to depart when there is high speed traffic operating on the intersecting runway (see FIG 2-1-9). Note that there must be an aircraft or vehicle in a position to observe the RILs for them to illuminate. Once the conflicting traffic passes through the intersection, the RILs extinguish.

2. RIL Operating Characteristics – Arriving Aircraft:

RILs will illuminate for an aircraft that has landed and is rolling out when there is high speed traffic on the intersecting runway that is ± 5 seconds of meeting at the intersection. Once the conflicting traffic passes through the intersection, the RILs extinguish.

3. What a pilot would observe: A pilot departing or arriving will observe RILs illuminate in reaction to the high speed traffic operation on the intersecting runway. The lights will extinguish when that traffic has passed through the runway intersection.

4. Whenever a pilot observes the red light of the RIL array, the pilot will stop before the LAHSO stop bar or the hold line for the intersecting runway. If a departing aircraft is already at high speed in the takeoff roll when the RILs illuminate, it may be impractical to stop for safety reasons. The crew should safely operate according to their best judgment while understanding the illuminated lights indicate that continuing the takeoff is unsafe. Contact ATC at the earliest possible opportunity.

e. The Final Approach Runway Occupancy Signal (FAROS) is communicated by flashing of the Precision Approach Path Indicator (PAPI) (see FIG 2-1-9). When activated, the light fixtures of the PAPI flash or pulse to indicate to the pilot on an approach that the runway is occupied and that it may be unsafe to land.

NOTE–

FAROS is an independent automatic alerting system that does not rely on ATC control or input.

1. FAROS Operating Characteristics:

If an aircraft or surface vehicle occupies a FAROS equipped runway, the PAPI(s) on that runway will flash. The glide path indication will not be affected, and the allotment of red and white PAPI lights observed by the pilot on approach will not change. The FAROS system will flash the PAPI when traffic enters the runway and there is an aircraft on approach and within 1.5 nautical miles of the landing threshold.

2. What a pilot would observe: A pilot on approach to the runway will observe the PAPI flash if there is traffic on the runway and will notice the PAPI ceases to flash when the traffic moves outside the hold short lines for the runway.

3. When a pilot observes a flashing PAPI at 500 feet above ground level (AGL), the contact height, the pilot must look for and acquire the traffic on the runway. At 300 feet AGL, the pilot must contact ATC for resolution if the FAROS indication is in conflict with the clearance. If the PAPI continues to flash, the pilot must execute an immediate “go around” and contact ATC at the earliest possible opportunity.

f. Pilot Actions:

1. When operating at airports with RWSL, pilots will operate with the transponder “On” when departing the gate or parking area until it is shutdown upon arrival at the gate or parking area. This ensures interaction with the FAA surveillance systems such as ASDE-X/Airport Surface Surveillance Capability (ASSC) which provide information to the RWSL system.

2. Pilots must always inform the ATCT when they have either stopped, are verifying a landing clearance, or are executing a go-around due to RWSL or FAROS indication that are in conflict with ATC instructions. Pilots must request clarification of the taxi, takeoff, or landing clearance.

3. Never cross over illuminated red lights. Under normal circumstances, RWSL will confirm the pilot’s taxi or takeoff clearance previously issued by ATC. If RWSL indicates that it is unsafe to takeoff from, land on, cross, or enter a runway, immediately notify ATC of the conflict and re-confirm the clearance.

4. Do not proceed when lights have extinguished without an ATC clearance. RWSL verifies an ATC clearance; it does not substitute for an ATC clearance.

5. Never land if PAPI continues to flash. Execute a go around and notify ATC.

g. ATC Control of RWSL System:

1. Controllers can set in-pavement lights to one of five (5) brightness levels to assure maximum conspicuity under all visibility and lighting conditions. REL, THL, and RIL subsystems may be independently set.

2. System lights can be disabled should RWSL operations impact the efficient movement of air traffic or contribute, in the opinion of the assigned ATC Manager, to unsafe operations. REL, THL, RIL, and FAROS light fixtures may be disabled separately. Disabling of the FAROS subsystem does not extinguish PAPI lights or impact its glide path function. Whenever the system or a component is disabled, a NOTAM must be issued, and the

Automatic Terminal Information System (ATIS) must be updated.

2-1-7. Stand-Alone Final Approach Runway Occupancy Signal (FAROS)

a. Introduction:

The stand-alone FAROS system is a fully automated system that provides runway occupancy status to pilots on final approach to indicate whether it may be unsafe to land. When an aircraft or vehicle is detected on the runway, the Precision Approach Path Indicator (PAPI) light fixtures flash as a signal to indicate that the runway is occupied and that it may be unsafe to land. The stand-alone FAROS system is activated by localized or comprehensive sensors detecting aircraft or ground vehicles occupying activation zones.

The stand-alone FAROS system monitors specific areas of the runway, called activation zones, to determine the presence of aircraft or ground vehicles in the zone (see FIG 2-1-10). These activation zones are defined as areas on the runway that are frequently occupied by ground traffic during normal airport operations and could present a hazard to landing aircraft. Activation zones may include the full-length departure position, the midfield departure position, or the entire runway.

Pilots can refer to the airport specific FAROS pilot information sheet for activation zone configuration.

**FIG 2-1-10
FAROS Activation Zones**

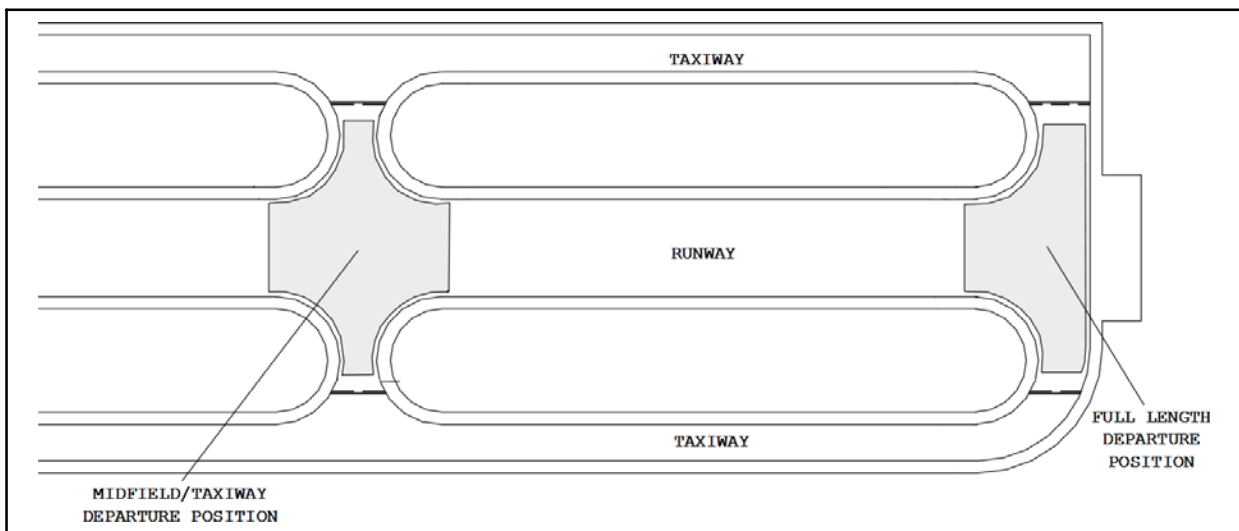

Clearance to land on a runway must be issued by Air Traffic Control (ATC). ATC personnel have limited

control over the system and may not be able to view the FAROS signal.

b. Operating Characteristics:

If an aircraft or ground vehicle occupies an activation zone on the runway, the PAPI light fixtures on that runway will flash. The glide path indication is not affected, i.e. the configuration of red and white PAPI lights observed by the pilot on approach does not change. The stand-alone FAROS system flashes the PAPI lights when traffic occupies an activation zone whether or not there is an aircraft on approach.

c. Pilot Observations:

A pilot on approach to the runway observes the PAPI lights flashing if there is traffic on the runway activation zones and notices the PAPI lights cease to flash when the traffic moves outside the activation zones.

A pilot on departure from the runway should disregard any observations of flashing PAPI lights.

d. Pilot Actions:

When a pilot observes a flashing PAPI at 500 feet above ground level (AGL), the pilot must look for and attempt to acquire the traffic on the runway. At 300 feet AGL, the pilot must contact ATC for resolution if the FAROS indication is in conflict with the clearance (see FIG 2-1-11). If the PAPI lights continue to flash and the pilot cannot visually determine that it is safe to land, the pilot must execute an immediate “go around”. As with operations at non-FAROS airports, it is always the pilot’s responsibility to determine whether or not it is safe to continue with the approach and to land on the runway.

**FIG 2-1-11
FAROS Glide Slope Action Points**

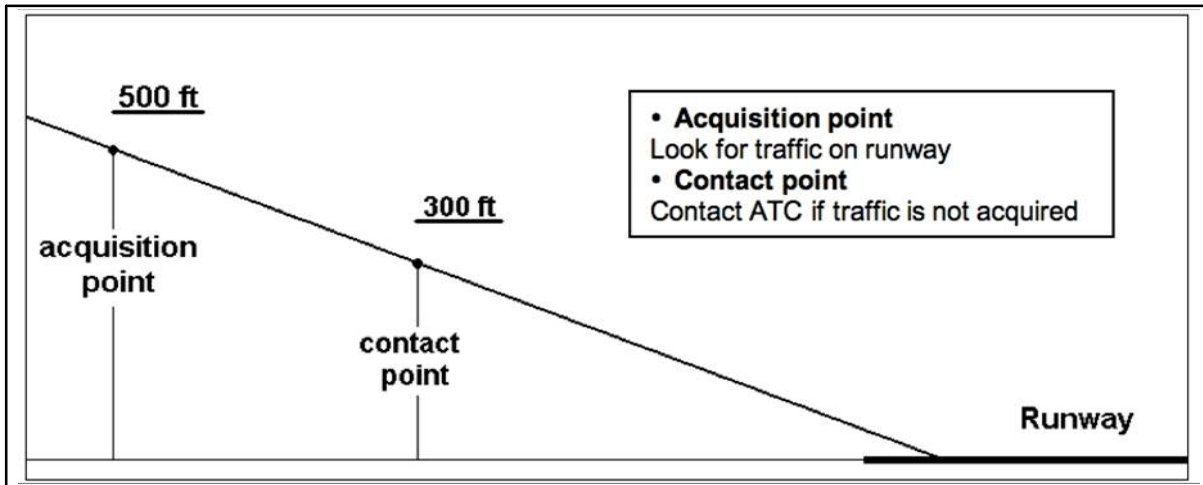

Pilots should inform the ATCT when they have executed a go around due to a FAROS indication that is in conflict with ATC instructions.

NOTE-
At this time, the stand-alone FAROS system is not widely implemented and is used for evaluation purposes.

2-1-8. Control of Lighting Systems

a. Operation of approach light systems and runway lighting is controlled by the control tower (ATCT). At some locations the FSS may control the lights where there is no control tower in operation.

b. Pilots may request that lights be turned on or off. Runway edge lights, in-pavement lights and approach lights also have intensity controls which may be varied to meet the pilots request. Sequenced

flashing lights (SFL) may be turned on and off. Some sequenced flashing light systems also have intensity control.

2-1-9. Pilot Control of Airport Lighting

Radio control of lighting is available at selected airports to provide airborne control of lights by keying the aircraft’s microphone. Control of lighting systems is often available at locations without specified hours for lighting and where there is no control tower or FSS or when the tower or FSS is closed (locations with a part-time tower or FSS) or specified hours. All lighting systems which are radio controlled at an airport, whether on a single runway or multiple runways, operate on the same radio frequency. (See TBL 2-1-1 and TBL 2-1-2.)

FIG 2-1-12
Runway Entrance Lights



FIG 2-1-13
Takeoff Hold Lights

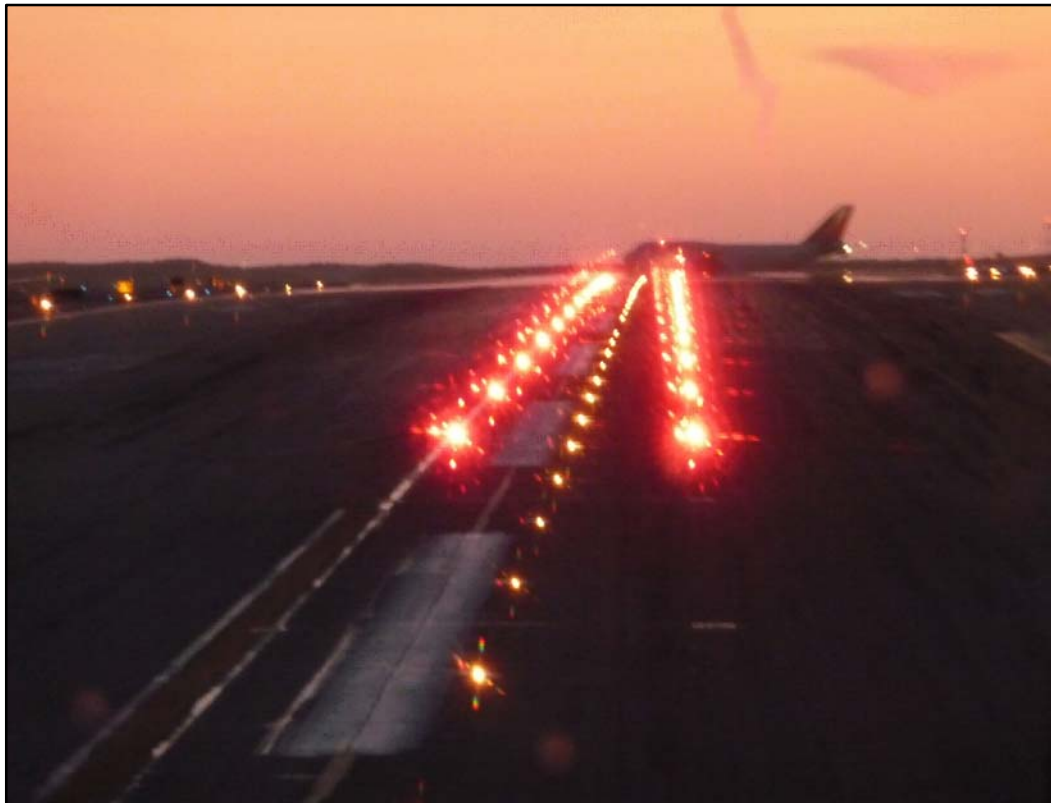

FIG 2-1-14
Taxiway Lead-On Light Configuration



TBL 2-1-1
Runways With Approach Lights

Lighting System	No. of Int. Steps	Status During Nonuse Period	Intensity Step Selected Per No. of Mike Clicks		
			3 Clicks	5 Clicks	7 Clicks
Approach Lights (Med. Int.)	2	Off	Low	Low	High
Approach Lights (Med. Int.)	3	Off	Low	Med	High
MIRL	3	Off or Low	◆	◆	◆
HIRL	5	Off or Low	◆	◆	◆
VASI	2	Off	☆	☆	☆

NOTES: ◆ Predetermined intensity step.
 ☆ Low intensity for night use. High intensity for day use as determined by photocell control.

TBL 2-1-2
Runways Without Approach Lights

Lighting System	No. of Int. Steps	Status During Nonuse Period	Intensity Step Selected Per No. of Mike Clicks		
			3 Clicks	5 Clicks	7 Clicks
MIRL	3	Off or Low	Low	Med.	High
HIRL	5	Off or Low	Step 1 or 2	Step 3	Step 5
LIRL	1	Off	On	On	On
VASI☆	2	Off	◆	◆	◆
REIL☆	1	Off	Off	On/Off	On
REIL☆	3	Off	Low	Med.	High

NOTES: ◆ Low intensity for night use. High intensity for day use as determined by photocell control.
 ☆ The control of VASI and/or REIL may be independent of other lighting systems.

a. With FAA approved systems, various combinations of medium intensity approach lights, runway lights, taxiway lights, VASI and/or REIL may be activated by radio control. On runways with both approach lighting and runway lighting (runway edge lights, taxiway lights, etc.) systems, the approach lighting system takes precedence for air-to-ground radio control over the runway lighting system which is set at a predetermined intensity step, based on expected visibility conditions. Runways without approach lighting may provide radio controlled intensity adjustments of runway edge lights. Other lighting systems, including VASI, REIL, and taxiway lights may be either controlled with the runway edge lights or controlled independently of the runway edge lights.

b. The control system consists of a 3-step control responsive to 7, 5, and/or 3 microphone clicks. This 3-step control will turn on lighting facilities capable of either 3-step, 2-step or 1-step operation. The 3-step and 2-step lighting facilities can be altered in intensity, while the 1-step cannot. All lighting is illuminated for a period of 15 minutes from the most recent time of activation and may not be extinguished prior to end of the 15 minute period (except for 1-step and 2-step REILs which may be turned off when desired by keying the mike 5 or 3 times respectively).

c. Suggested use is to always initially key the mike 7 times; this assures that all controlled lights are turned on to the maximum available intensity. If desired, adjustment can then be made, where the capability is provided, to a lower intensity (or the REIL turned off) by keying 5 and/or 3 times. Due to the close proximity of airports using the same frequency, radio controlled lighting receivers may be set at a low sensitivity requiring the aircraft to be relatively close to activate the system. Consequently, even when lights are on, always key mike as directed when overflying an airport of intended landing or just prior to entering the final segment of an approach. This will assure the aircraft is close enough to activate the system and a full 15 minutes lighting duration is available. Approved lighting systems may be activated by keying the mike (within 5 seconds) as indicated in TBL 2-1-3.

**TBL 2-1-3
Radio Control System**

Key Mike	Function
7 times within 5 seconds	Highest intensity available
5 times within 5 seconds	Medium or lower intensity (Lower REIL or REIL-off)
3 times within 5 seconds	Lowest intensity available (Lower REIL or REIL-off)

d. For all public use airports with FAA standard systems the Chart Supplement U.S. contains the types of lighting, runway and the frequency that is used to activate the system. Airports with IAPs include data on the approach chart identifying the light system, the runway on which they are installed, and the frequency that is used to activate the system.

NOTE-

Although the CTAF is used to activate the lights at many airports, other frequencies may also be used. The appropriate frequency for activating the lights on the airport is provided in the Chart Supplement U.S. and the standard instrument approach procedures publications. It is not identified on the sectional charts.

e. Where the airport is not served by an IAP, it may have either the standard FAA approved control system or an independent type system of different specification installed by the airport sponsor. The Chart Supplement U.S. contains descriptions of pilot controlled lighting systems for each airport having other than FAA approved systems, and explains the type lights, method of control, and operating frequency in clear text.

2-1-10. Airport/Heliport Beacons

a. Airport and heliport beacons have a vertical light distribution to make them most effective from one to ten degrees above the horizon; however, they can be seen well above and below this peak spread. The beacon may be an omnidirectional capacitor-discharge device, or it may rotate at a constant speed which produces the visual effect of flashes at regular intervals. Flashes may be one or two colors alternately. The total number of flashes are:

1. 24 to 30 per minute for beacons marking airports, landmarks, and points on Federal airways.
2. 30 to 45 per minute for beacons marking heliports.

b. The colors and color combinations of beacons are:

1. White and Green– Lighted land airport.
2. *Green alone– Lighted land airport.
3. White and Yellow– Lighted water airport.
4. *Yellow alone– Lighted water airport.
5. Green, Yellow, and White– Lighted heliport.

NOTE–

**Green alone or yellow alone is used only in connection with a white-and-green or white-and-yellow beacon display, respectively.*

c. Military airport beacons flash alternately white and green, but are differentiated from civil beacons by dualpeaked (two quick) white flashes between the green flashes.

d. In Class B, Class C, Class D and Class E surface areas, operation of the airport beacon during the hours of daylight often indicates that the ground visibility is less than 3 miles and/or the ceiling is less than 1,000 feet. ATC clearance in accordance with 14 CFR Part 91 is required for landing, takeoff and flight in the traffic pattern. Pilots should not rely solely on the operation of the airport beacon to indicate if weather conditions are IFR or VFR. At some locations with operating control towers, ATC personnel turn the beacon on or off when controls are in the tower. At many airports the airport beacon is turned on by a photoelectric cell or time clocks and ATC personnel cannot control them. There is no regulatory requirement for daylight operation and it is the pilot's responsibility to comply with proper preflight planning as required by 14 CFR Section 91.103.

2-1-11. Taxiway Lights

a. Taxiway Edge Lights. Taxiway edge lights are used to outline the edges of taxiways during periods of darkness or restricted visibility conditions. These fixtures emit blue light.

NOTE–

At most major airports these lights have variable intensity settings and may be adjusted at pilot request or when deemed necessary by the controller.

b. Taxiway Centerline Lights. Taxiway centerline lights are used to facilitate ground traffic under low visibility conditions. They are located along the taxiway centerline in a straight line on straight

portions, on the centerline of curved portions, and along designated taxiing paths in portions of runways, ramp, and apron areas. Taxiway centerline lights are steady burning and emit green light.

c. Clearance Bar Lights. Clearance bar lights are installed at holding positions on taxiways in order to increase the conspicuity of the holding position in low visibility conditions. They may also be installed to indicate the location of an intersecting taxiway during periods of darkness. Clearance bars consist of three in-pavement steady-burning yellow lights.

d. Runway Guard Lights. Runway guard lights are installed at taxiway/runway intersections. They are primarily used to enhance the conspicuity of taxiway/runway intersections during low visibility conditions, but may be used in all weather conditions. Runway guard lights consist of either a pair of elevated flashing yellow lights installed on either side of the taxiway, or a row of in-pavement yellow lights installed across the entire taxiway, at the runway holding position marking.

NOTE–

Some airports may have a row of three or five in-pavement yellow lights installed at taxiway/runway intersections. They should not be confused with clearance bar lights described in paragraph 2-1-11 c, Clearance Bar Lights.

e. Stop Bar Lights. Stop bar lights, when installed, are used to confirm the ATC clearance to enter or cross the active runway in low visibility conditions (below 1,200 ft Runway Visual Range). A stop bar consists of a row of red, unidirectional, steady-burning in-pavement lights installed across the entire taxiway at the runway holding position, and elevated steady-burning red lights on each side. A controlled stop bar is operated in conjunction with the taxiway centerline lead-on lights which extend from the stop bar toward the runway. Following the ATC clearance to proceed, the stop bar is turned off and the lead-on lights are turned on. The stop bar and lead-on lights are automatically reset by a sensor or backup timer.

CAUTION–

Pilots should never cross a red illuminated stop bar, even if an ATC clearance has been given to proceed onto or across the runway.

NOTE–

If after crossing a stop bar, the taxiway centerline lead-on lights inadvertently extinguish, pilots should hold their position and contact ATC for further instructions.

Section 2. Air Navigation and Obstruction Lighting

2-2-1. Aeronautical Light Beacons

a. An aeronautical light beacon is a visual NAVAID displaying flashes of white and/or colored light to indicate the location of an airport, a heliport, a landmark, a certain point of a Federal airway in mountainous terrain, or an obstruction. The light used may be a rotating beacon or one or more flashing lights. The flashing lights may be supplemented by steady burning lights of lesser intensity.

b. The color or color combination displayed by a particular beacon and/or its auxiliary lights tell whether the beacon is indicating a landing place, landmark, point of the Federal airways, or an obstruction. Coded flashes of the auxiliary lights, if employed, further identify the beacon site.

2-2-2. Code Beacons and Course Lights

a. **Code Beacons.** The code beacon, which can be seen from all directions, is used to identify airports and landmarks. The code beacon flashes the three or four character airport identifier in International Morse Code six to eight times per minute. Green flashes are displayed for land airports while yellow flashes indicate water airports.

b. **Course Lights.** The course light, which can be seen clearly from only one direction, is used only with rotating beacons of the Federal Airway System: two course lights, back to back, direct coded flashing beams of light in either direction along the course of airway.

NOTE-

Airway beacons are remnants of the "lighted" airways which antedated the present electronically equipped federal airways system. Only a few of these beacons exist today to mark airway segments in remote mountain areas. Flashes in Morse code identify the beacon site.

2-2-3. Obstruction Lights

a. Obstructions are marked/lighted to warn airmen of their presence during daytime and nighttime conditions. They may be marked/lighted in any of the following combinations:

1. Aviation Red Obstruction Lights. Flashing aviation red beacons (20 to 40 flashes per minute) and steady burning aviation red lights during nighttime operation. Aviation orange and white paint is used for daytime marking.

2. Medium Intensity Flashing White Obstruction Lights. Medium intensity flashing white obstruction lights may be used during daytime and twilight with automatically selected reduced intensity for nighttime operation. When this system is used on structures 500 feet (153m) AGL or less in height, other methods of marking and lighting the structure may be omitted. Aviation orange and white paint is always required for daytime marking on structures exceeding 500 feet (153m) AGL. This system is not normally installed on structures less than 200 feet (61m) AGL.

3. High Intensity White Obstruction Lights. Flashing high intensity white lights during daytime with reduced intensity for twilight and nighttime operation. When this type system is used, the marking of structures with red obstruction lights and aviation orange and white paint may be omitted.

4. Dual Lighting. A combination of flashing aviation red beacons and steady burning aviation red lights for nighttime operation and flashing high intensity white lights for daytime operation. Aviation orange and white paint may be omitted.

5. Catenary Lighting. Lighted markers are available for increased night conspicuity of high-voltage (69KV or higher) transmission line catenary wires. Lighted markers provide conspicuity both day and night.

b. Medium intensity omnidirectional flashing white lighting system provides conspicuity both day and night on catenary support structures. The unique sequential/simultaneous flashing light system alerts pilots of the associated catenary wires.

c. High intensity flashing white lights are being used to identify some supporting structures of overhead transmission lines located across rivers, chasms, gorges, etc. These lights flash in a middle, top, lower light sequence at approximately 60 flashes per minute. The top light is normally installed near the top of the supporting structure, while the lower light indicates the approximate lower portion of the

wire span. The lights are beamed towards the companion structure and identify the area of the wire span.

d. High intensity flashing white lights are also employed to identify tall structures, such as chimneys

and towers, as obstructions to air navigation. The lights provide a 360 degree coverage about the structure at 40 flashes per minute and consist of from one to seven levels of lights depending upon the height of the structure. Where more than one level is used the vertical banks flash simultaneously.

Section 3. Airport Marking Aids and Signs

2-3-1. General

a. Airport pavement markings and signs provide information that is useful to a pilot during takeoff, landing, and taxiing.

b. Uniformity in airport markings and signs from one airport to another enhances safety and improves efficiency. Pilots are encouraged to work with the operators of the airports they use to achieve the marking and sign standards described in this section.

c. Pilots who encounter ineffective, incorrect, or confusing markings or signs on an airport should make the operator of the airport aware of the problem. These situations may also be reported under the Aviation Safety Reporting Program as described in Paragraph 7-6-1, Aviation Safety Reporting Program. Pilots may also report these situations to the FAA regional airports division.

d. The markings and signs described in this section of the AIM reflect the current FAA recommended standards.

REFERENCE-

AC 150/5340-1, Standards for Airport Markings.

AC 150/5340-18, Standards for Airport Sign Systems.

2-3-2. Airport Pavement Markings

a. **General.** For the purpose of this section, the airport pavement markings have been grouped into four areas:

1. **Runway Markings.**
2. **Taxiway Markings.**
3. **Holding Position Markings.**
4. **Other Markings.**

b. **Marking Colors.** Markings for runways are white. Markings defining the landing area on a heliport are also white except for hospital heliports which use a red “H” on a white cross. Markings for taxiways, areas not intended for use by aircraft (closed and hazardous areas), and holding positions (even if they are on a runway) are yellow.

2-3-3. Runway Markings

a. **General.** There are three types of markings for runways: visual, nonprecision instrument, and precision instrument. TBL 2-3-1 identifies the marking elements for each type of runway and TBL 2-3-2 identifies runway threshold markings.

TBL 2-3-1
Runway Marking Elements

Marking Element	Visual Runway	Nonprecision Instrument Runway	Precision Instrument Runway
Designation	X	X	X
Centerline	X	X	X
Threshold	X ¹	X	X
Aiming Point	X ²	X	X
Touchdown Zone			X
Side Stripes			X
¹ On runways used, or intended to be used, by international commercial transports. ² On runways 4,000 feet (1200 m) or longer used by jet aircraft.			

FIG 2-3-1
Precision Instrument Runway Markings

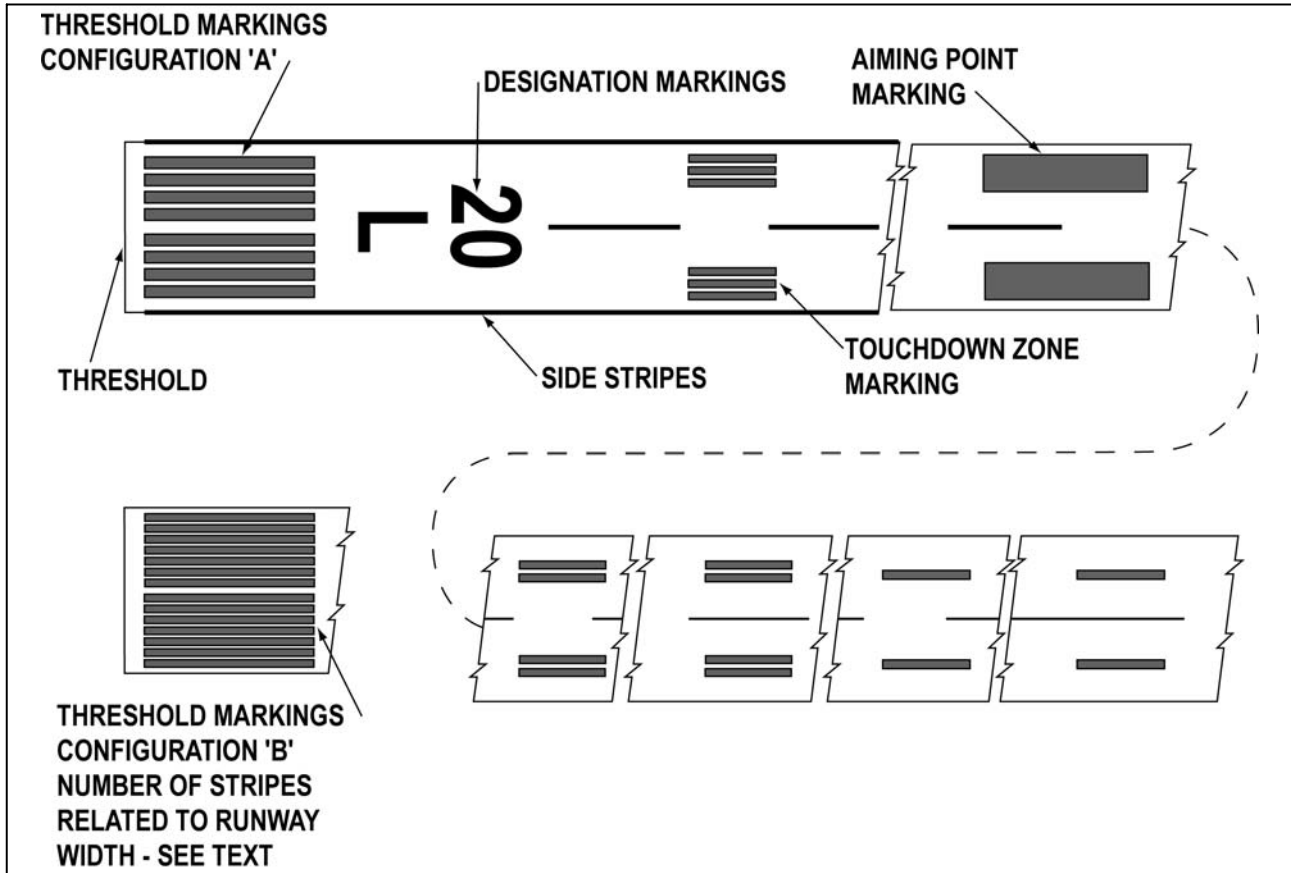

b. Runway Designators. Runway numbers and letters are determined from the approach direction. The runway number is the whole number nearest one-tenth the magnetic azimuth of the centerline of the runway, measured clockwise from the magnetic north. The letters, differentiate between left (L), right (R), or center (C) parallel runways, as applicable:

1. For two parallel runways “L” “R.”
2. For three parallel runways “L” “C” “R.”

c. Runway Centerline Marking. The runway centerline identifies the center of the runway and provides alignment guidance during takeoff and landings. The centerline consists of a line of uniformly spaced stripes and gaps.

d. Runway Aiming Point Marking. The aiming point marking serves as a visual aiming point for a landing aircraft. These two rectangular markings consist of a broad white stripe located on each side of the runway centerline and approximately 1,000 feet from the landing threshold, as shown in FIG 2-3-1, Precision Instrument Runway Markings.

e. Runway Touchdown Zone Markers. The touchdown zone markings identify the touchdown zone for landing operations and are coded to provide distance information in 500 feet (150m) increments. These markings consist of groups of one, two, and three rectangular bars symmetrically arranged in pairs about the runway centerline, as shown in FIG 2-3-1. For runways having touchdown zone markings on both ends, those pairs of markings which extend to within 900 feet (270 m) of the midpoint between the thresholds are eliminated.

FIG 2-3-2
Nonprecision Instrument Runway and Visual Runway Markings

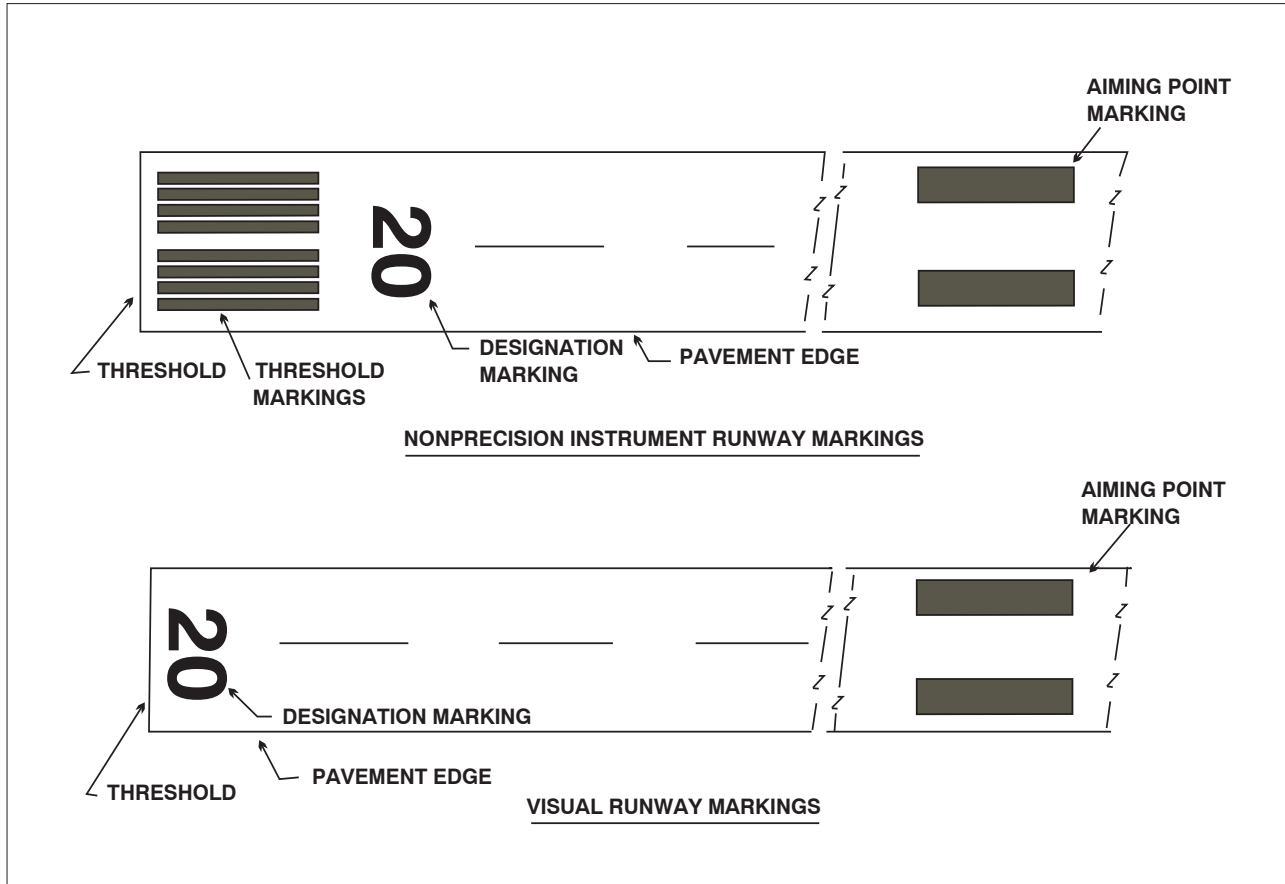

f. Runway Side Stripe Marking. Runway side stripes delineate the edges of the runway. They provide a visual contrast between runway and the abutting terrain or shoulders. Side stripes consist of continuous white stripes located on each side of the runway as shown in FIG 2-3-4.

g. Runway Shoulder Markings. Runway shoulder stripes may be used to supplement runway side stripes to identify pavement areas contiguous to the runway sides that are not intended for use by aircraft. Runway shoulder stripes are yellow. (See FIG 2-3-5.)

h. Runway Threshold Markings. Runway threshold markings come in two configurations. They either consist of eight longitudinal stripes of uniform

dimensions disposed symmetrically about the runway centerline (as shown in FIG 2-3-1) or the number of stripes is related to the runway width as indicated in TBL 2-3-2. A threshold marking helps identify the beginning of the runway that is available for landing. In some instances, the landing threshold may be relocated or displaced.

TBL 2-3-2
Number of Runway Threshold Stripes

Runway Width	Number of Stripes
60 feet (18 m)	4
75 feet (23 m)	6
100 feet (30 m)	8
150 feet (45 m)	12
200 feet (60 m)	16

1. Relocation of a Threshold. Sometimes construction, maintenance, or other activities require the threshold to be relocated towards the rollout end of the runway. (See FIG 2-3-3.) When a threshold is relocated, it closes not only a set portion of the approach end of a runway, but also shortens the length of the opposite direction runway. In these cases, a NOTAM should be issued by the airport operator identifying the portion of the runway that is closed (for example, 10/28 W 900 CLSD). Because the duration of the relocation can vary from a few hours to several months, methods identifying the new threshold may vary. One common practice is to use a ten feet wide white threshold bar across the width of the runway. Although the runway lights in the area between the old threshold and new threshold will not be illuminated, the runway markings in this area may or may not be obliterated, removed, or covered.

2. Displaced Threshold. A displaced threshold is a threshold located at a point on the runway other than the designated beginning of the runway. Displacement of a threshold reduces the length of runway available for landings. The portion of runway behind a displaced threshold is available for takeoffs in either direction and landings from the opposite direction. A ten feet wide white threshold bar is

located across the width of the runway at the displaced threshold. White arrows are located along the centerline in the area between the beginning of the runway and displaced threshold. White arrow heads are located across the width of the runway just prior to the threshold bar, as shown in FIG 2-3-4.

NOTE-

Airport operator. When reporting the relocation or displacement of a threshold, the airport operator should avoid language which confuses the two.

i. Demarcation Bar. A demarcation bar delineates a runway with a displaced threshold from a blast pad, stopway, or taxiway that precedes the runway. A demarcation bar is 3 feet (1m) wide and yellow, since it is not located on the runway, as shown in FIG 2-3-6.

1. Chevrons. These markings are used to show pavement areas aligned with the runway that are unusable for landing, takeoff, and taxiing. Chevrons are yellow. (See FIG 2-3-7.)

j. Runway Threshold Bar. A threshold bar delineates the beginning of the runway that is available for landing when the threshold has been relocated or displaced. A threshold bar is 10 feet (3m) in width and extends across the width of the runway, as shown in FIG 2-3-4.

FIG 2-3-3
Relocation of a Threshold with Markings for Taxiway Aligned with Runway

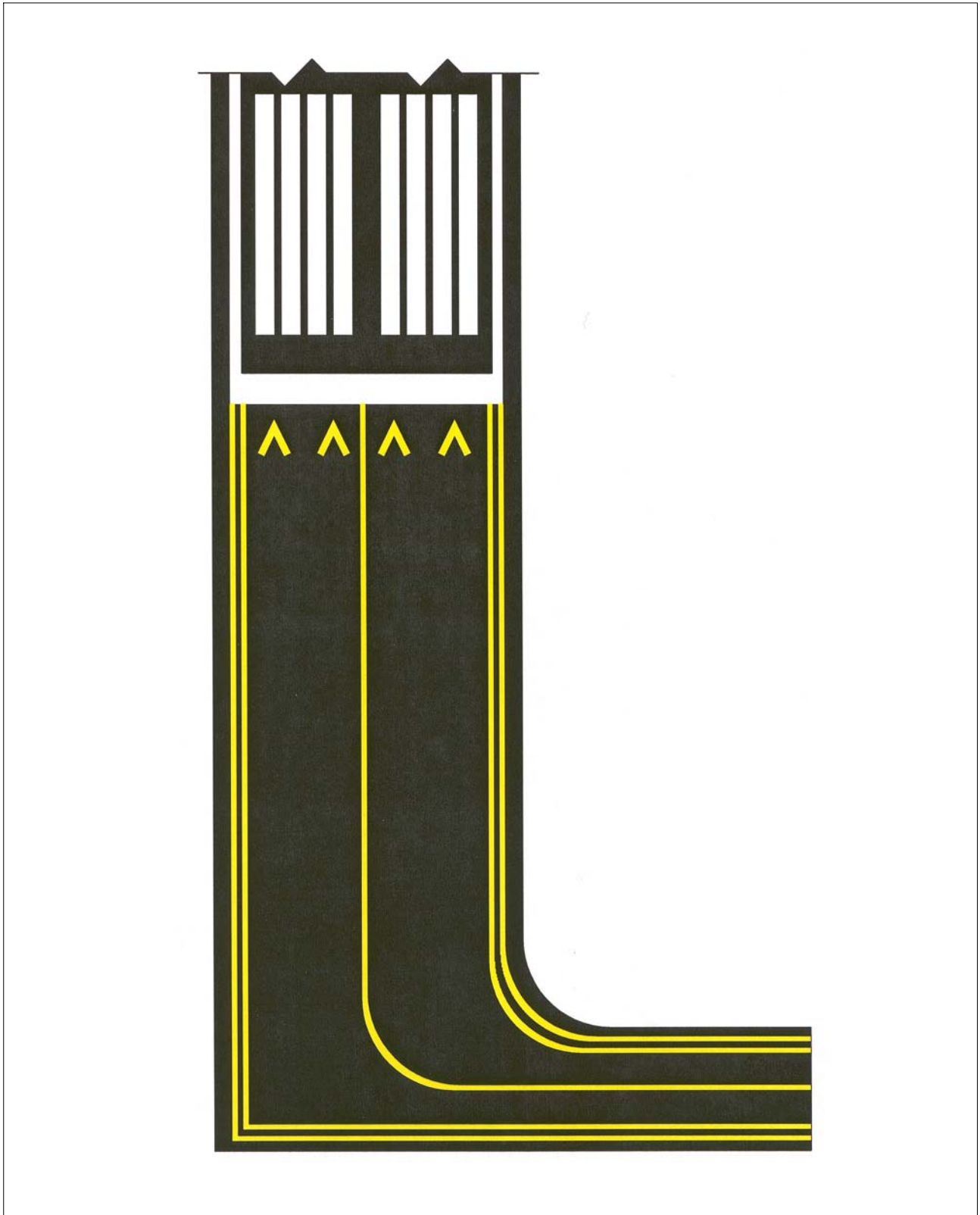

FIG 2-3-4
Displaced Threshold Markings

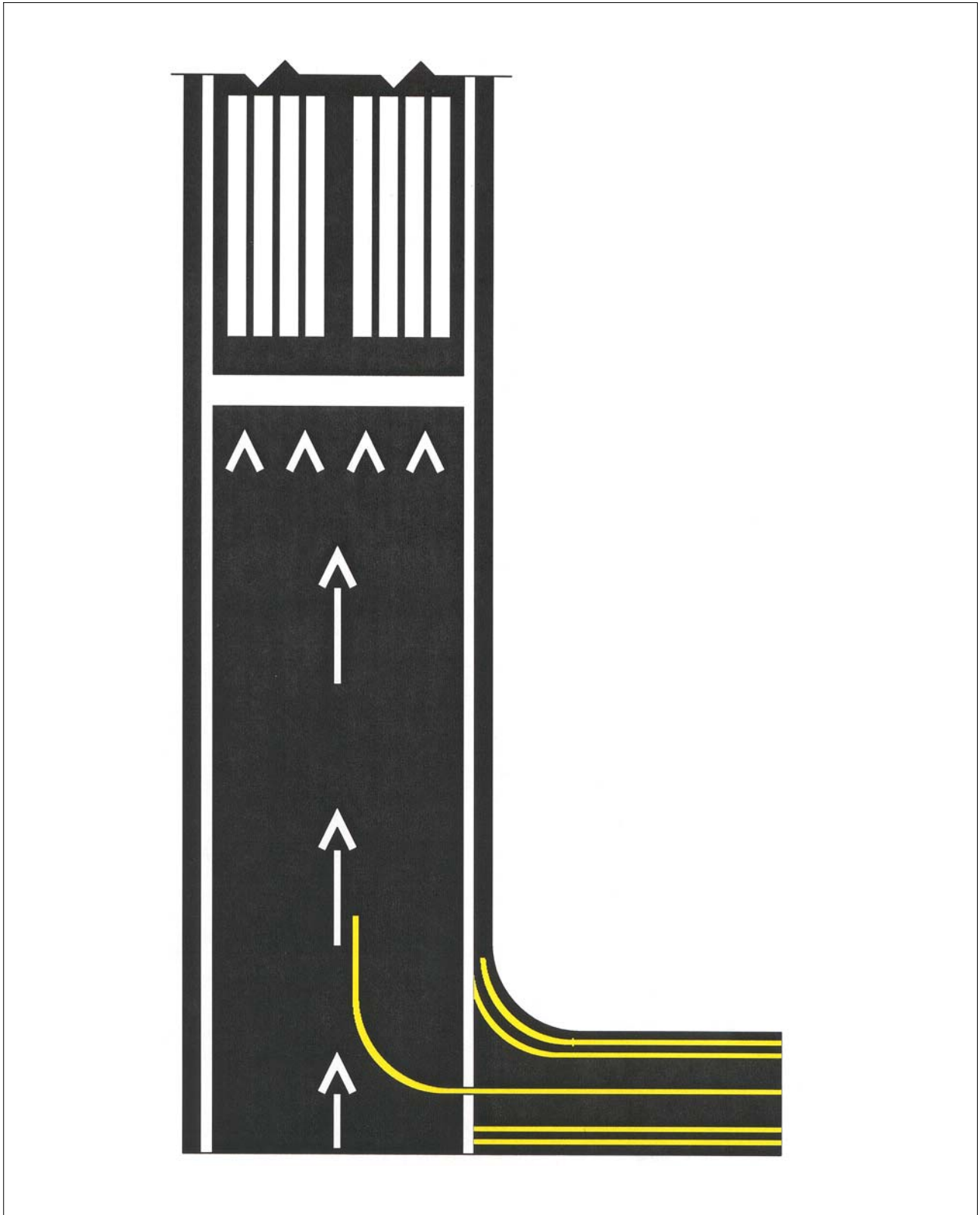
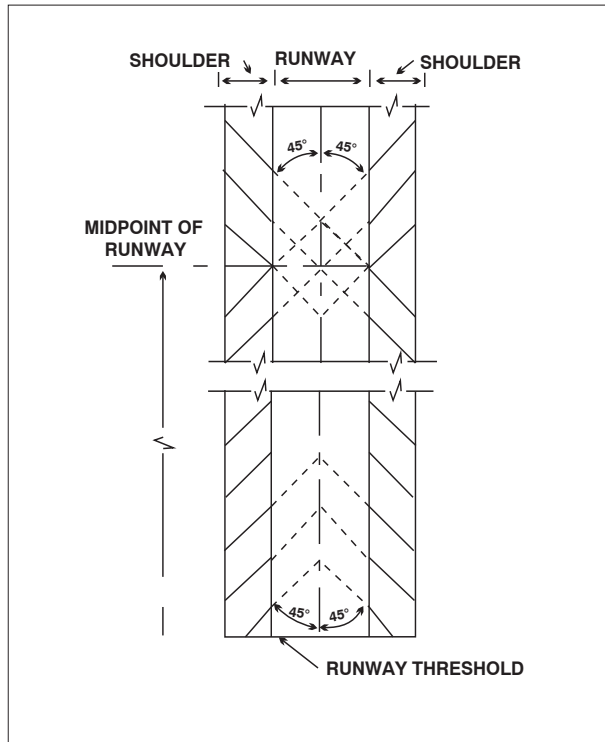

FIG 2-3-5
Runway Shoulder Markings



2-3-4. Taxiway Markings

a. General. All taxiways should have centerline markings and runway holding position markings whenever they intersect a runway. Taxiway edge markings are present whenever there is a need to separate the taxiway from a pavement that is not intended for aircraft use or to delineate the edge of the taxiway. Taxiways may also have shoulder markings and holding position markings for Instrument Landing System (ILS) critical areas and taxiway/taxiway intersection markings.

REFERENCE-
AIM Paragraph 2-3-5, Holding Position Markings

b. Taxiway Centerline.

1. Normal Centerline. The taxiway centerline is a single continuous yellow line, 6 inches (15 cm) to 12 inches (30 cm) in width. This provides a visual cue to permit taxiing along a designated path. Ideally, the aircraft should be kept centered over this line during taxi. However, being centered on the taxiway centerline does not guarantee wingtip clearance with other aircraft or other objects.

2. Enhanced Centerline. At some airports, mostly the larger commercial service airports, an enhanced taxiway centerline will be used. The enhanced taxiway centerline marking consists of a parallel line of yellow dashes on either side of the normal taxiway centerline. The taxiway centerlines are enhanced for a maximum of 150 feet prior to a runway holding position marking. The purpose of this enhancement is to warn the pilot that he/she is approaching a runway holding position marking and should prepare to stop unless he/she has been cleared onto or across the runway by ATC. (See FIG 2-3-8.)

c. Taxiway Edge Markings. Taxiway edge markings are used to define the edge of the taxiway. They are primarily used when the taxiway edge does not correspond with the edge of the pavement. There are two types of markings depending upon whether the aircraft is supposed to cross the taxiway edge:

1. Continuous Markings. These consist of a continuous double yellow line, with each line being at least 6 inches (15 cm) in width spaced 6 inches (15 cm) apart. They are used to define the taxiway edge from the shoulder or some other abutting paved surface not intended for use by aircraft.

2. Dashed Markings. These markings are used when there is an operational need to define the edge of a taxiway or taxilane on a paved surface where the adjoining pavement to the taxiway edge is intended for use by aircraft (for example, an apron). Dashed taxiway edge markings consist of a broken double yellow line, with each line being at least 6 inches (15 cm) in width, spaced 6 inches (15 cm) apart (edge to edge). These lines are 15 feet (4.5 m) in length with 25 foot (7.5 m) gaps. (See FIG 2-3-9.)

d. Taxi Shoulder Markings. Taxiways, holding bays, and aprons are sometimes provided with paved shoulders to prevent blast and water erosion. Although shoulders may have the appearance of full strength pavement, they are not intended for use by aircraft and may be unable to support an aircraft. Usually the taxiway edge marking will define this area. Where conditions exist such as islands or taxiway curves that may cause confusion as to which side of the edge stripe is for use by aircraft, taxiway shoulder markings may be used to indicate the pavement is unusable. Taxiway shoulder markings are yellow. (See FIG 2-3-10.)

FIG 2-3-6
Markings for Blast Pad or Stopway or Taxiway Preceding a Displaced Threshold

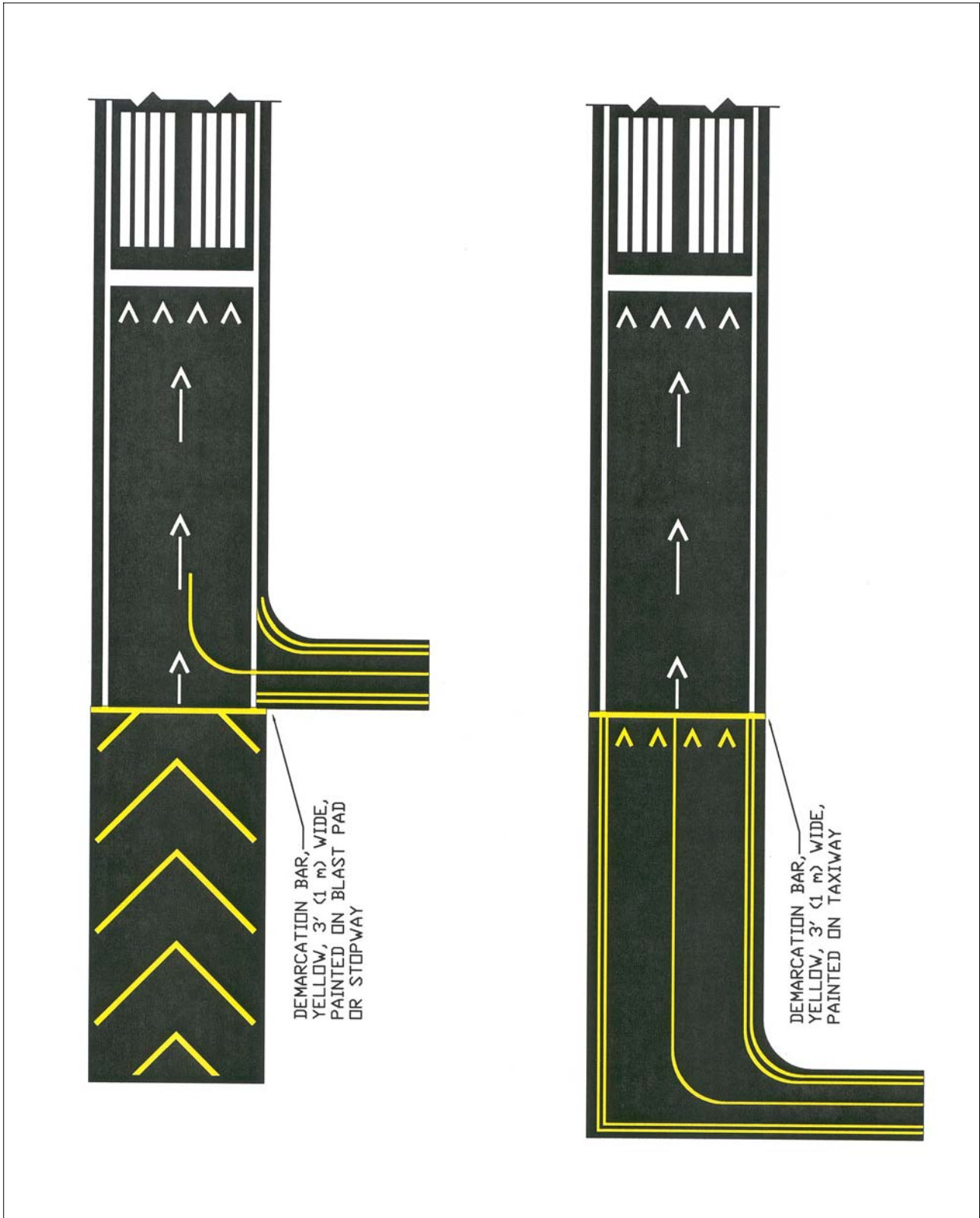
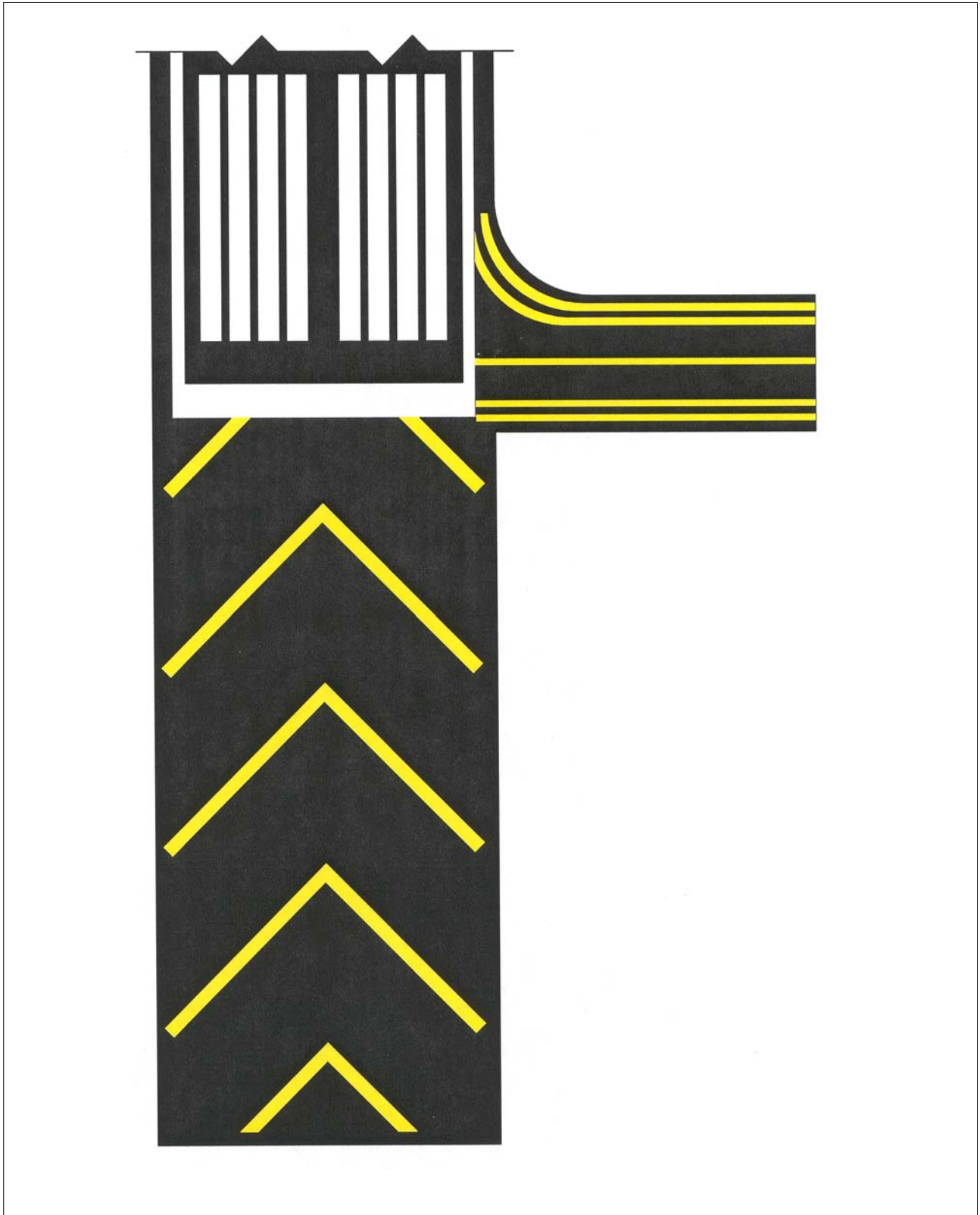
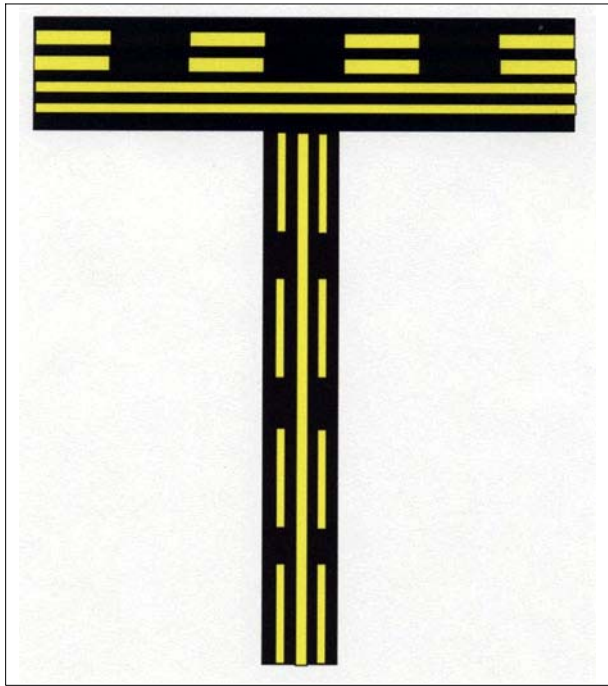

FIG 2-3-7
Markings for Blast Pads and Stopways



**FIG 2-3-8
Enhanced Taxiway Centerline**



**FIG 2-3-9
Dashed Markings**

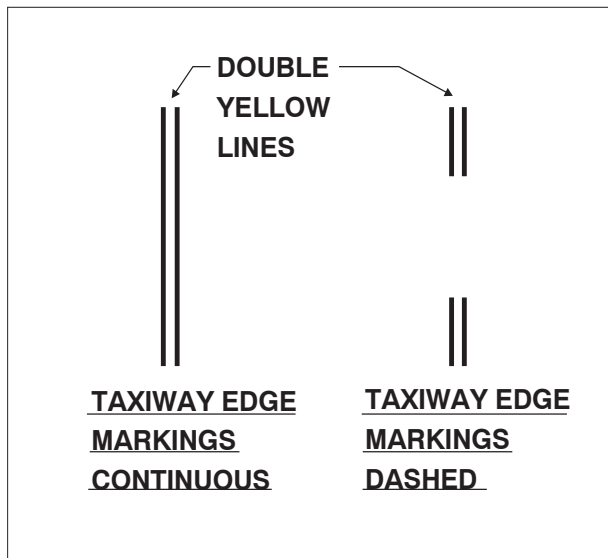

e. Surface Painted Taxiway Direction Signs. Surface painted taxiway direction signs have a yellow background with a black inscription, and are provided when it is not possible to provide taxiway direction signs at intersections, or when necessary to supplement such signs. These markings are located adjacent to the centerline with signs indicating turns to the left being on the left side of the taxiway

centerline, and signs indicating turns to the right being on the right side of the centerline. (See FIG 2-3-11.)

**FIG 2-3-10
Taxi Shoulder Markings**

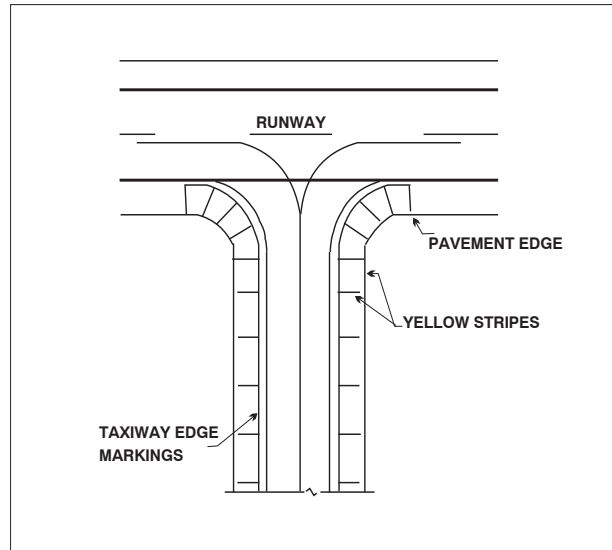

f. Surface Painted Location Signs. Surface painted location signs have a black background with a yellow inscription. When necessary, these markings are used to supplement location signs located along side the taxiway and assist the pilot in confirming the designation of the taxiway on which the aircraft is located. These markings are located on the right side of the centerline. (See FIG 2-3-11.)

g. Geographic Position Markings. These markings are located at points along low visibility taxi routes designated in the airport's Surface Movement Guidance Control System (SMGCS) plan. They are used to identify the location of taxiing aircraft during low visibility operations. Low visibility operations are those that occur when the runway visible range (RVR) is below 1200 feet (360m). They are positioned to the left of the taxiway centerline in the direction of taxiing. (See FIG 2-3-12.) The geographic position marking is a circle comprised of an outer black ring contiguous to a white ring with a pink circle in the middle. When installed on asphalt or other dark-colored pavements, the white ring and the black ring are reversed (i.e., the white ring becomes the outer ring and the black ring becomes the inner ring). It is designated with either a number or a number and letter. The number corresponds to the consecutive position of the marking on the route.

FIG 2-3-11
Surface Painted Signs

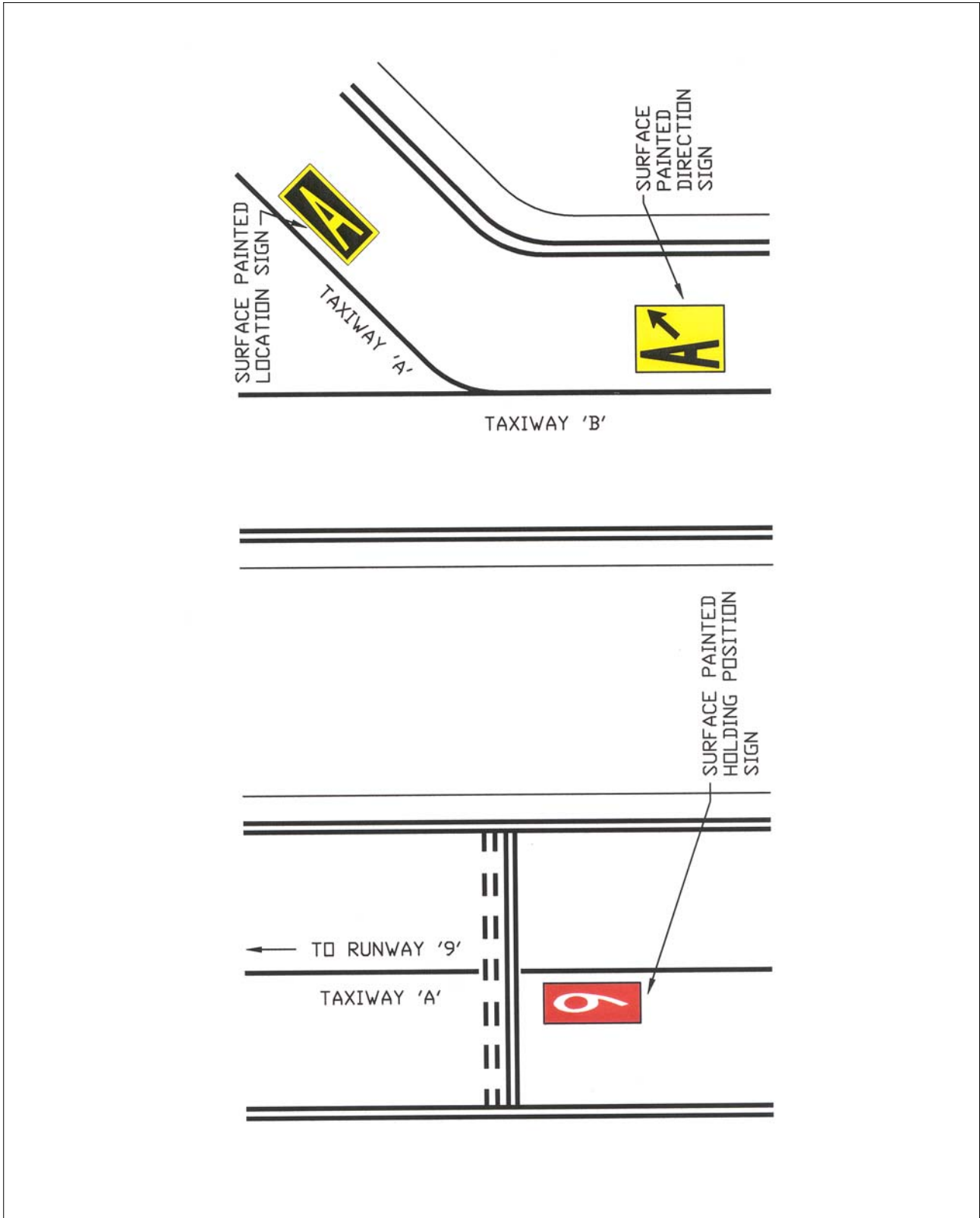

2-3-5. Holding Position Markings

a. Runway Holding Position Markings. For runways, these markings indicate where aircraft **MUST STOP** when approaching a runway. They consist of four yellow lines, two solid and two dashed, spaced six or twelve inches apart, and extending across the width of the taxiway or runway. The solid lines are always on the side where the aircraft must hold. There are three locations where runway holding position markings are encountered.

1. Runway Holding Position Markings on Taxiways. These markings identify the locations on a taxiway where aircraft **MUST STOP** when a clearance has not been issued to proceed onto the runway. Generally, runway holding position markings also identify the boundary of the runway safety area (RSA) for aircraft exiting the runway. Runway holding position markings are shown in FIG 2-3-13 and FIG 2-3-16. When instructed by ATC, “*Hold short of Runway XX*,” the pilot **MUST STOP** so that no part of the aircraft extends beyond the runway holding position marking. When approaching runways at airports with an operating control tower, pilots must not cross the runway holding position marking without ATC clearance. Pilots approaching runways at airports without an operating control tower must ensure adequate separation from other aircraft, vehicles, and pedestrians prior to crossing the holding position markings. An aircraft exiting a runway is not clear of the runway until all parts of the aircraft have crossed the applicable holding position marking.

NOTE-

Runway holding position markings identify the beginning of an RSA, and a pilot MUST STOP to get clearance before crossing (at airports with operating control towers).

REFERENCE-

AIM, Paragraph 4-3-20, Exiting the Runway After Landing

2. Runway Holding Position Markings on Runways. These markings identify the locations on runways where aircraft **MUST STOP**. These markings are located on runways used by ATC for Land And Hold Short Operations (for example, see FIG 4-3-8) and Taxiing operations. For taxiing operations, the pilot **MUST STOP** prior to the holding position markings unless explicitly authorized to cross by ATC. A sign with a white inscription on a red background is located adjacent to these holding position markings. (See FIG 2-3-14.) The holding position markings are placed on runways prior to the intersection with another runway, or some designated

point. Pilots receiving and accepting instructions “*Cleared to land Runway XX, hold short of Runway YY*” from ATC must either exit Runway XX prior to the holding position markings, or stop at the holding position markings prior to Runway YY. Otherwise, pilots are authorized to use the entire landing length of the runway and disregard the holding position markings.

3. Holding Position Markings on Taxiways Located in Runway Approach Areas. These markings are used at some airports where it is necessary to hold an aircraft on a taxiway located in the approach or departure area of a runway so that the aircraft does not interfere with the operations on that runway. This marking is collocated with the runway approach/departure area holding position sign. When specifically instructed by ATC, “*Hold short of Runway XX approach or Runway XX departure area*,” the pilot **MUST STOP** so that no part of the aircraft extends beyond the holding position marking. (See Subparagraph 2-3-8b2, Runway Approach Area Holding Position Sign, and FIG 2-3-15.)

b. Holding Position Markings for Instrument Landing System (ILS). Holding position markings for ILS critical areas consist of two yellow solid lines spaced two feet apart connected by pairs of solid lines spaced ten feet apart extending across the width of the taxiway as shown. (See FIG 2-3-16.) A sign with an inscription in white on a red background is located adjacent to these hold position markings. When instructed by ATC to hold short of the ILS critical area, pilots **MUST STOP** so that no part of the aircraft extends beyond the holding position marking. When approaching the holding position marking, pilots must not cross the marking without ATC clearance. The ILS critical area is not clear until all parts of the aircraft have crossed the applicable holding position marking.

REFERENCE-

AIM, Paragraph 1-1-9, Instrument Landing System (ILS)

c. Holding Position Markings for Intersecting Taxiways Holding position markings for intersecting taxiways consist of a single dashed line extending across the width of the taxiway as shown. (See FIG 2-3-17.) They are located on taxiways where ATC holds aircraft short of a taxiway intersection. When instructed by ATC, “*Hold short of Taxiway XX*,” the pilot **MUST STOP** so that no part of the aircraft extends beyond the holding position marking. When the marking is not present, the pilot **MUST**

STOP the aircraft at a point which provides adequate clearance from an aircraft on the intersecting taxiway.

d. Surface Painted Holding Position Signs.
 Surface painted holding position signs have a red background with a white inscription and supplement

the signs located at the holding position. This type of marking is normally used where the width of the holding position on the taxiway is greater than 200 feet (60 m). It is located to the left side of the taxiway centerline on the holding side and prior to the holding position marking. (See FIG 2-3-11.)

FIG 2-3-12
Geographic Position Markings

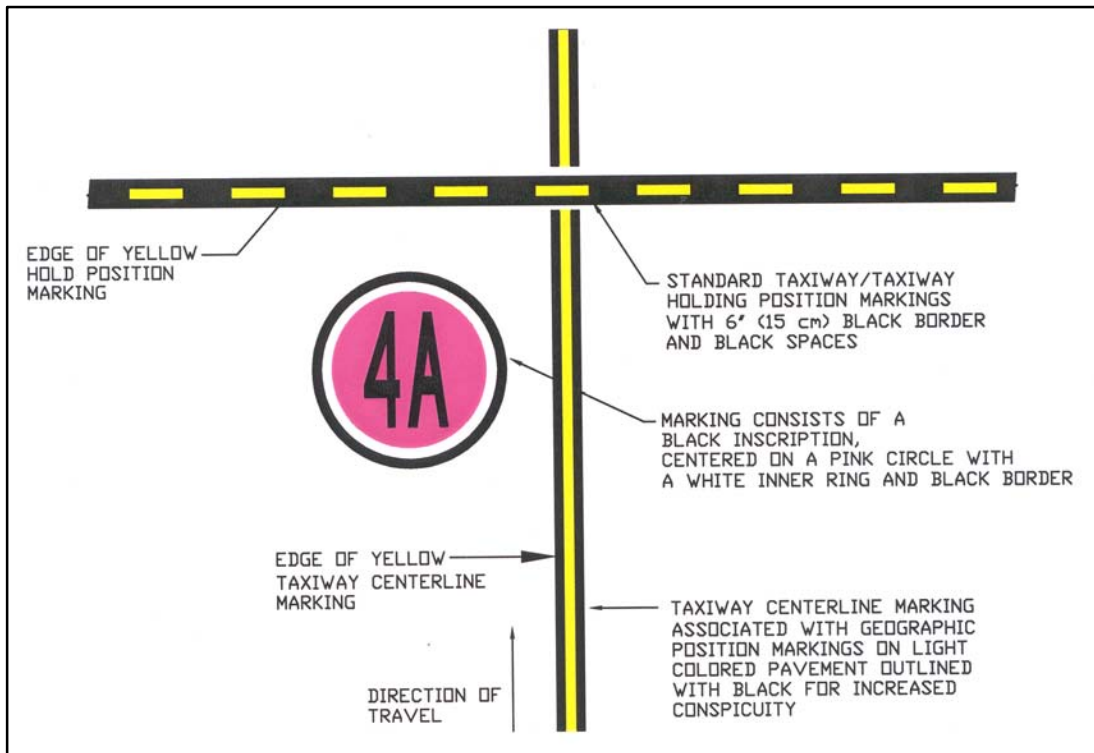

FIG 2-3-13
Runway Holding Position Markings on Taxiway

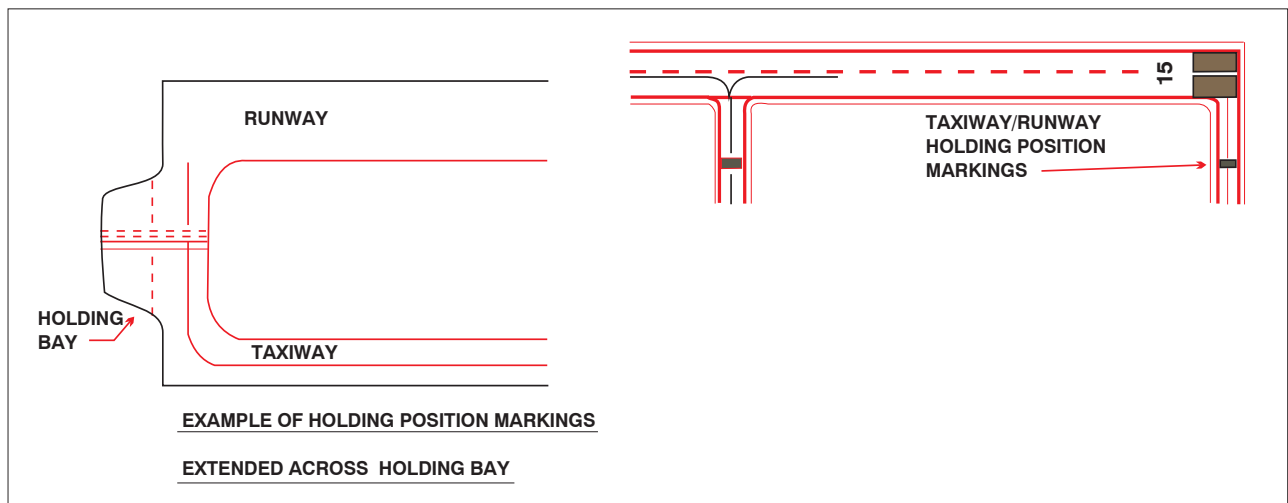

FIG 2-3-14
Runway Holding Position Markings on Runways

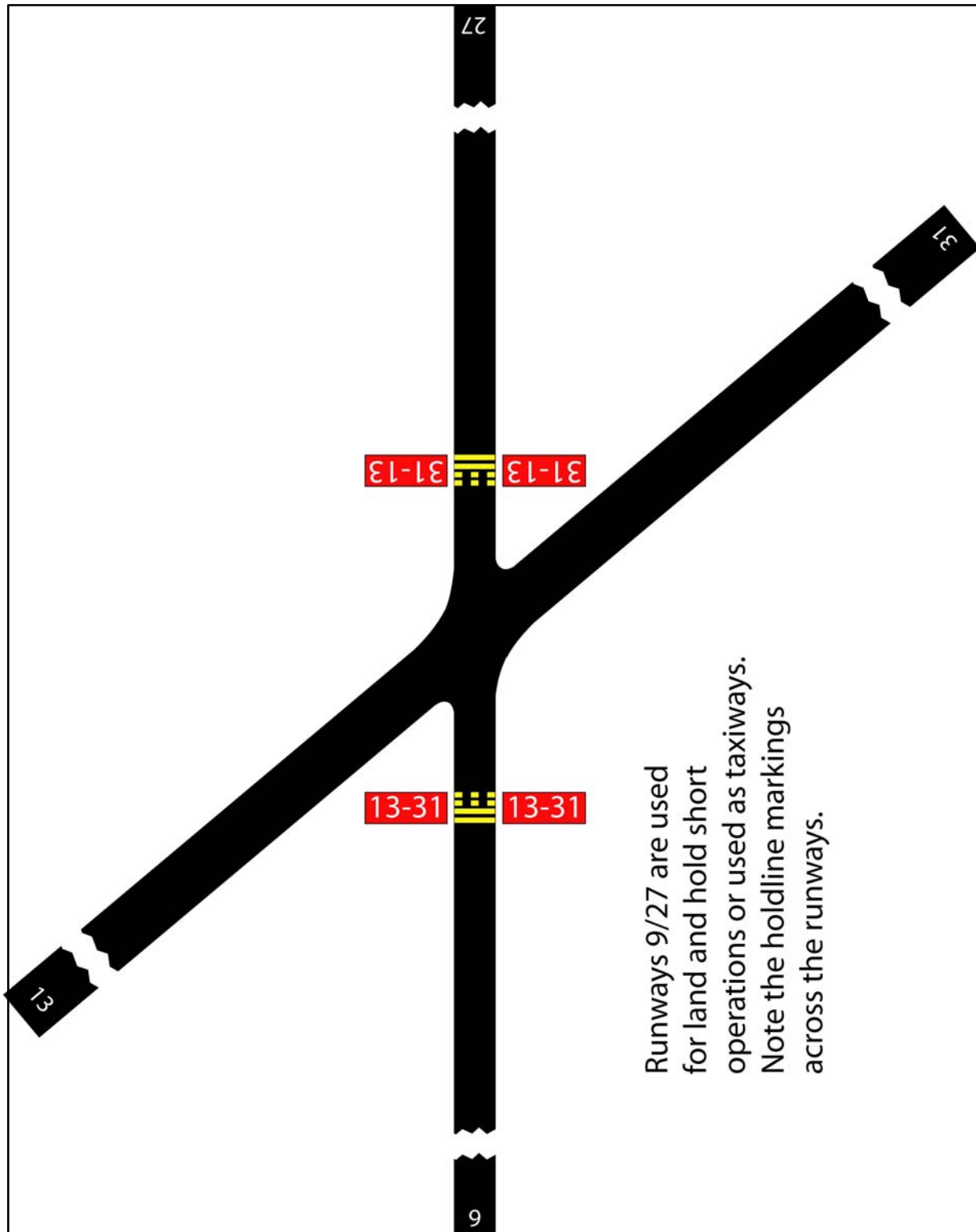
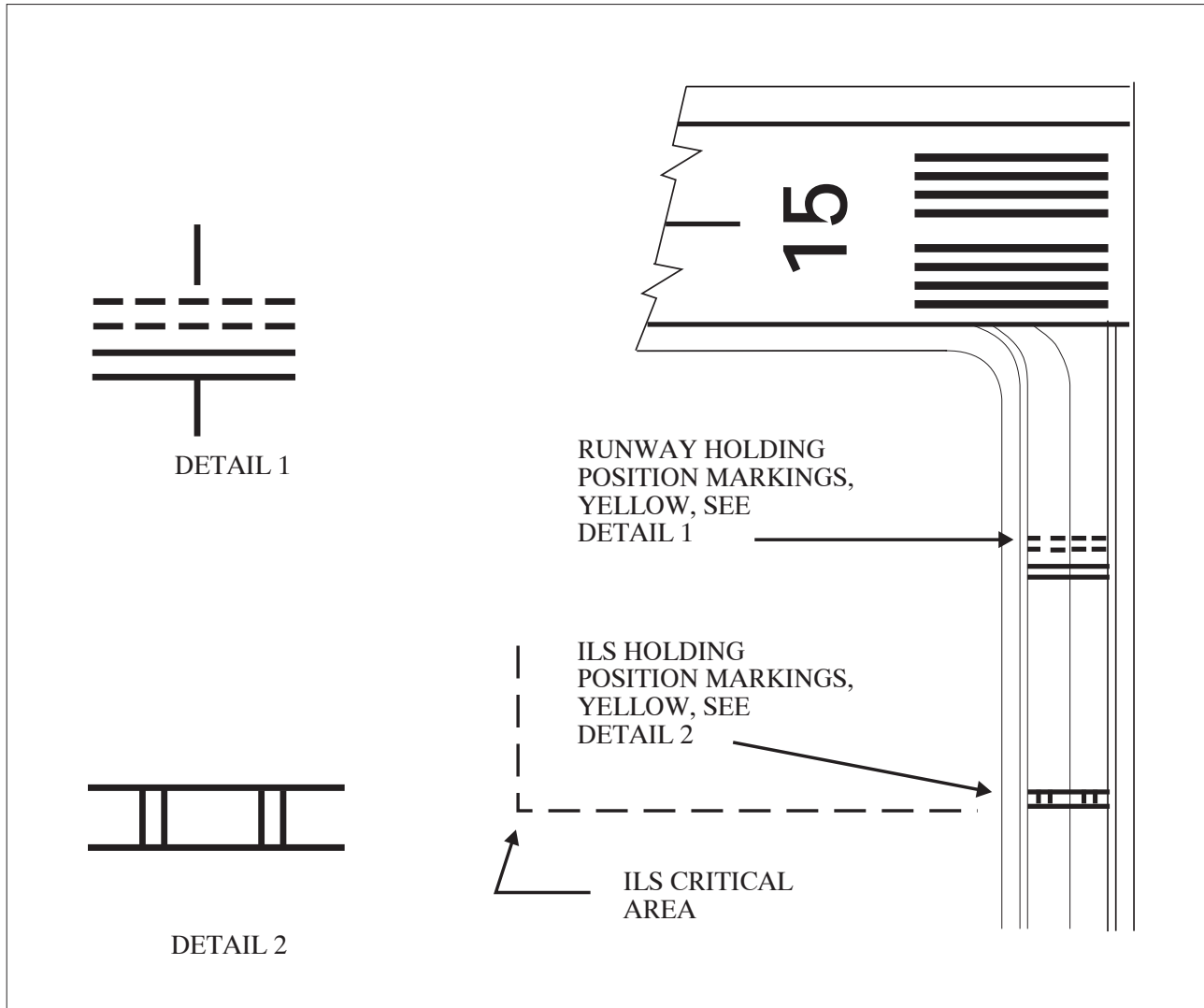

FIG 2-3-16
Holding Position Markings: ILS Critical Area



2-3-6. Other Markings

a. Vehicle Roadway Markings. The vehicle roadway markings are used when necessary to define a pathway for vehicle operations on or crossing areas that are also intended for aircraft. These markings consist of a white solid line to delineate each edge of the roadway and a dashed line to separate lanes within the edges of the roadway. In lieu of the solid lines, zipper markings may be used to delineate the edges of the vehicle roadway. (See FIG 2-3-18.) Details of the zipper markings are shown in FIG 2-3-19.

b. VOR Receiver Checkpoint Markings. The VOR receiver checkpoint marking allows the pilot to check aircraft instruments with navigational aid signals. It consists of a painted circle with an arrow in

the middle; the arrow is aligned in the direction of the checkpoint azimuth. This marking, and an associated sign, is located on the airport apron or taxiway at a point selected for easy access by aircraft but where other airport traffic is not to be unduly obstructed. (See FIG 2-3-20.)

NOTE-
The associated sign contains the VOR station identification letter and course selected (published) for the check, the words "VOR check course," and DME data (when applicable). The color of the letters and numerals are black on a yellow background.

EXAMPLE-
*DCA 176-356
 VOR check course
 DME XXX*

FIG 2-3-17
Holding Position Markings: Taxiway/Taxiway Intersections

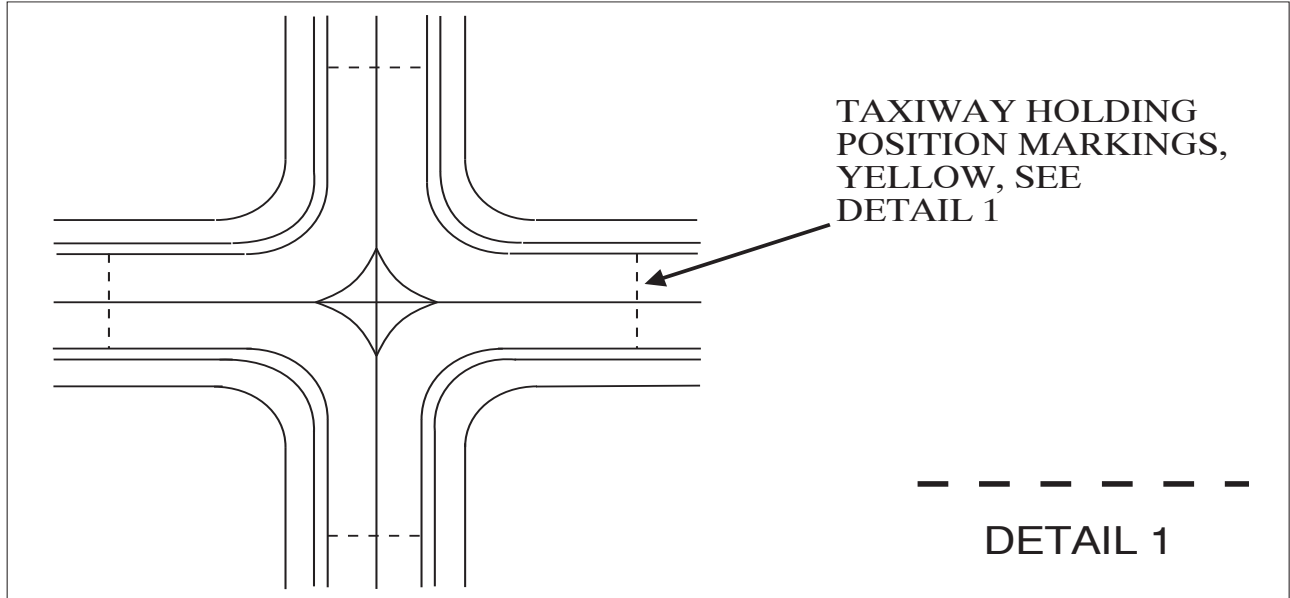

FIG 2-3-18
Vehicle Roadway Markings

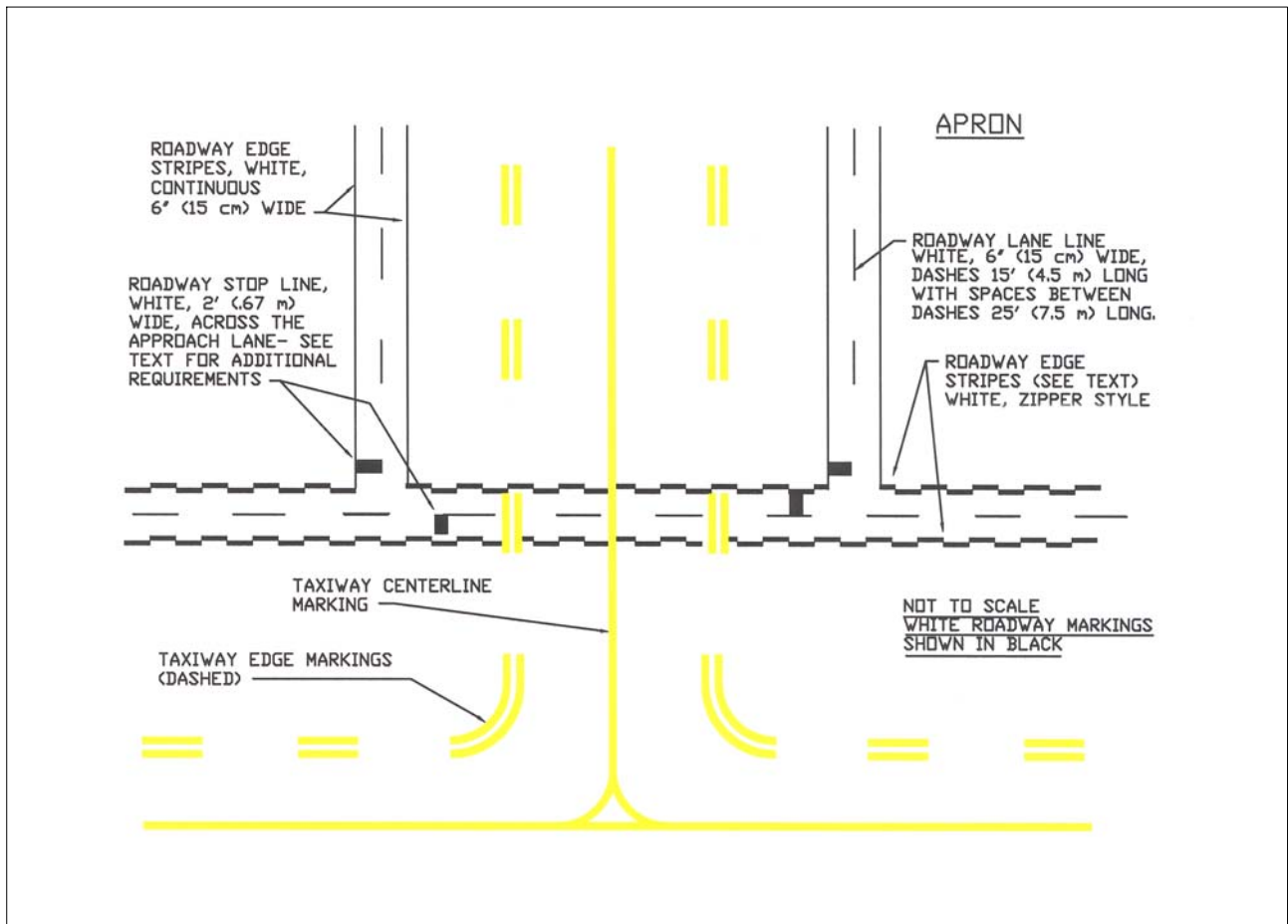

FIG 2-3-19
Roadway Edge Stripes, White, Zipper Style

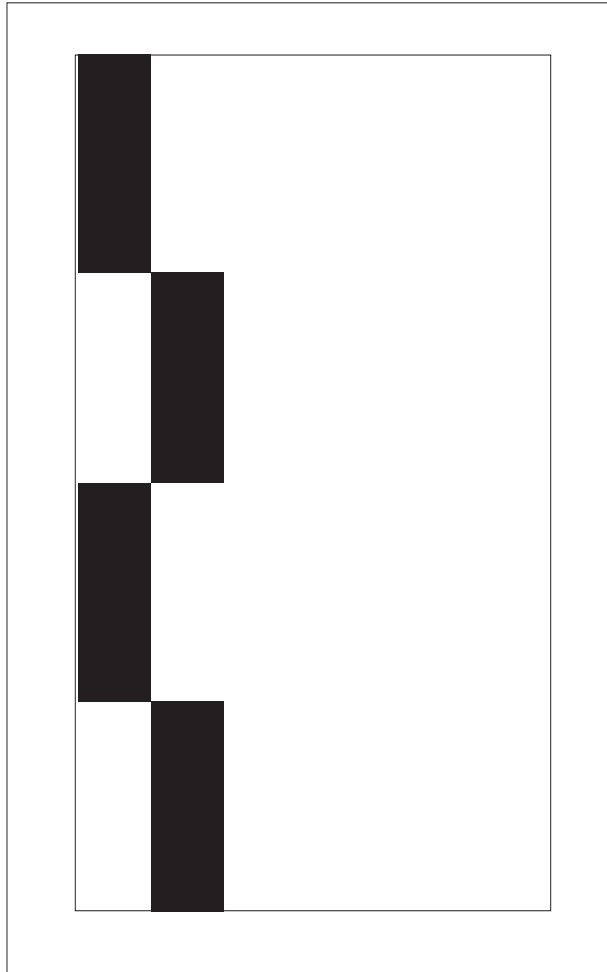

FIG 2-3-20
Ground Receiver Checkpoint Markings

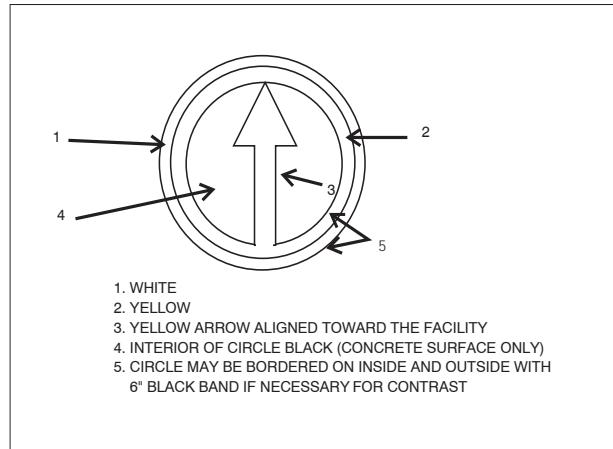

FIG 2-3-21
Nonmovement Area Boundary Markings

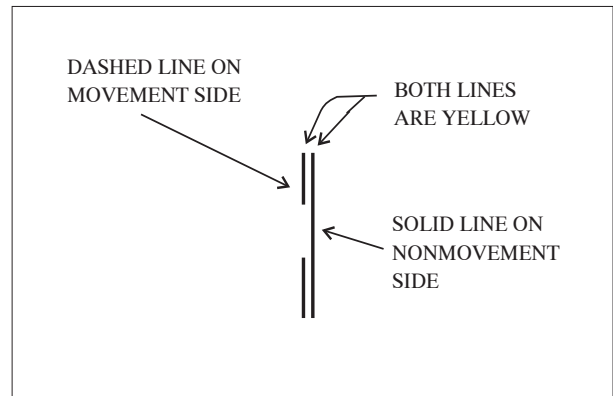
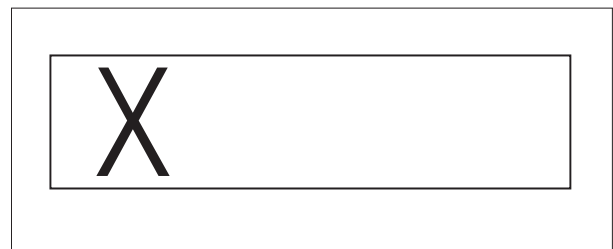

FIG 2-3-22
Closed or Temporarily Closed Runway and Taxiway Markings



c. Nonmovement Area Boundary Markings. These markings delineate the movement area (i.e., area under ATC). These markings are yellow and located on the boundary between the movement and nonmovement area. The nonmovement area boundary markings consist of two yellow lines (one solid and one dashed) 6 inches (15cm) in width. The solid line is located on the nonmovement area side, while the dashed yellow line is located on the movement area side. The nonmovement boundary marking area is shown in FIG 2-3-21.

d. Marking and Lighting of Permanently Closed Runways and Taxiways. For runways and taxiways which are permanently closed, the lighting circuits will be disconnected. The runway threshold, runway designation, and touchdown markings are obliterated and yellow crosses are placed at each end of the runway and at 1,000 foot intervals. (See FIG 2-3-22.)

FIG 2-3-23
Helicopter Landing Areas



e. Temporarily Closed Runways and Taxiways. To provide a visual indication to pilots that a runway is temporarily closed, crosses are placed on the runway only at each end of the runway. The crosses are yellow in color. (See FIG 2-3-22.)

1. A raised lighted yellow cross may be placed on each runway end in lieu of the markings described in Subparagraph e, Temporarily Closed Runways and Taxiways, to indicate the runway is closed.

2. A visual indication may not be present depending on the reason for the closure, duration of the closure, airfield configuration, and the existence and the hours of operation of an airport traffic control tower. Pilots should check NOTAMs and the Automated Terminal Information System (ATIS) for local runway and taxiway closure information.

3. Temporarily closed taxiways are usually treated as hazardous areas, in which no part of an aircraft may enter, and are blocked with barricades. However, as an alternative, a yellow cross may be installed at each entrance to the taxiway.

f. Helicopter Landing Areas. The markings illustrated in FIG 2-3-23 are used to identify the landing and takeoff area at a public use heliport and hospital heliport. The letter “H” in the markings is oriented to align with the intended direction of approach. FIG 2-3-23 also depicts the markings for a closed airport.

2-3-7. Airport Signs

There are six types of signs installed on airfields: mandatory instruction signs, location signs, direction signs, destination signs, information signs, and runway distance remaining signs. The characteristics and use of these signs are discussed in Paragraph 2-3-8, Mandatory Instruction Signs, through Paragraph 2-3-13, Runway Distance Remaining Signs.

REFERENCE—
AC150/5340-18, Standards for Airport Sign Systems for Detailed Information on Airport Signs.

FIG 2-3-24
Runway Holding Position Sign



FIG 2-3-25
Holding Position Sign at Beginning of Takeoff Runway



2-3-8. Mandatory Instruction Signs

a. These signs have a red background with a white inscription and are used to denote:

1. An entrance to a runway or critical area; and
2. Areas where an aircraft is prohibited from entering.

b. **Typical mandatory signs and applications are:**

1. **Runway Holding Position Sign.** This sign is located at the holding position on taxiways that intersect a runway or on runways that intersect other

runways. The inscription on the sign contains the designation of the intersecting runway, as shown in FIG 2-3-24. The runway numbers on the sign are arranged to correspond to the respective runway threshold. For example, “15-33” indicates that the threshold for Runway 15 is to the left and the threshold for Runway 33 is to the right.

(a) On taxiways that intersect the beginning of the takeoff runway, only the designation of the takeoff runway may appear on the sign (as shown in FIG 2-3-25), while all other signs will have the designation of both runway directions.

FIG 2-3-26

Holding Position Sign for a Taxiway that Intersects the Intersection of Two Runways

FIG 2-3-27

Holding Position Sign for a Runway Approach Area

(b) If the sign is located on a taxiway that intersects the intersection of two runways, the designations for both runways will be shown on the sign along with arrows showing the approximate alignment of each runway, as shown in FIG 2-3-26. In addition to showing the approximate runway alignment, the arrow indicates the direction to the threshold of the runway whose designation is immediately next to the arrow.

(c) A runway holding position sign on a taxiway will be installed adjacent to holding position markings on the taxiway pavement. On runways, holding position markings will be located only on the runway pavement adjacent to the sign, if the runway is normally used by ATC for “Land, Hold Short” operations or as a taxiway. The holding position

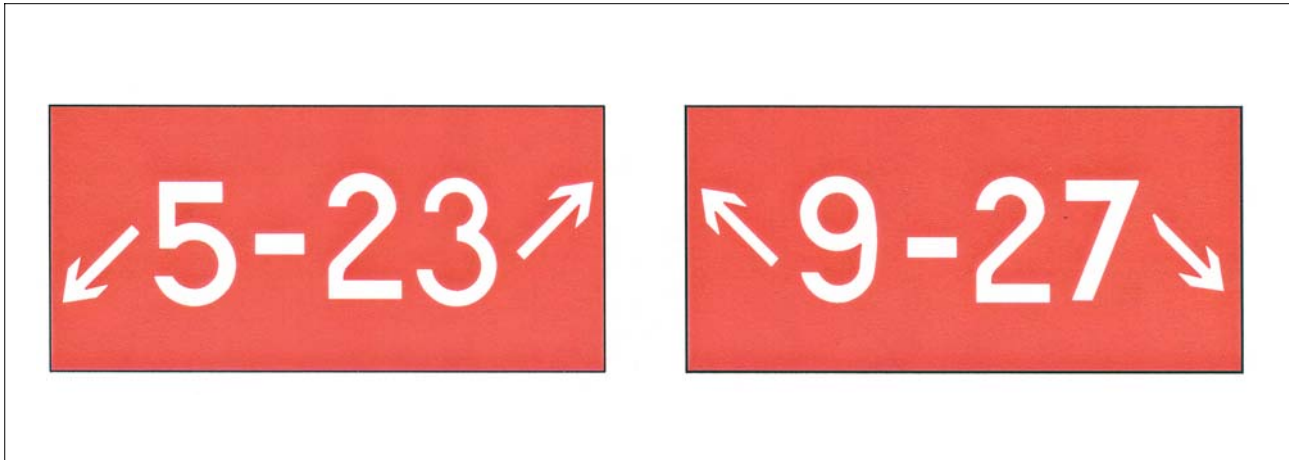
markings are described in Paragraph 2-3-5, Holding Position Markings.

2. Runway Approach Area Holding Position Sign. At some airports, it is necessary to hold an aircraft on a taxiway located in the approach or departure area for a runway so that the aircraft does not interfere with operations on that runway. In these situations, a sign with the designation of the approach end of the runway followed by a “dash” (-) and letters “APCH” will be located at the holding position on the taxiway. Holding position markings in accordance with Paragraph 2-3-5, Holding Position Markings, will be located on the taxiway pavement. An example of this sign is shown in FIG 2-3-27. In this example, the sign may protect the approach to Runway 15 and/or the departure for Runway 33.

FIG 2-3-28

Holding Position Sign for ILS Critical Area

FIG 2-3-29

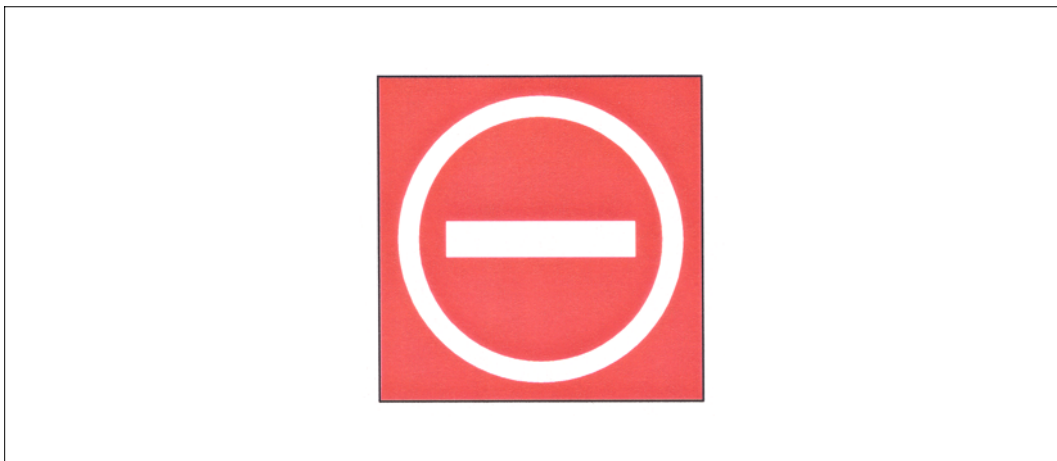
Sign Prohibiting Aircraft Entry into an Area

3. ILS Critical Area Holding Position Sign. At some airports, when the instrument landing system is being used, it is necessary to hold an aircraft on a taxiway at a location other than the holding position described in Paragraph 2-3-5, Holding Position Markings. In these situations, the holding position sign for these operations will have the inscription "ILS" and be located adjacent to the holding position marking on the taxiway described in paragraph 2-3-5. An example of this sign is shown in FIG 2-3-28.

4. No Entry Sign. This sign, shown in FIG 2-3-29, prohibits an aircraft from entering an area. Typically, this sign would be located on a taxiway intended to be used in only one direction or at the intersection of vehicle roadways with runways, taxiways, or aprons where the roadway may be mistaken as a taxiway or other aircraft movement surface.

NOTE-

Holding position signs provide the pilot with a visual cue as to the location of the holding position marking.

REFERENCE-

AIM Paragraph 2-3-5, Holding Position Markings

FIG 2-3-30
Taxiway Location Sign

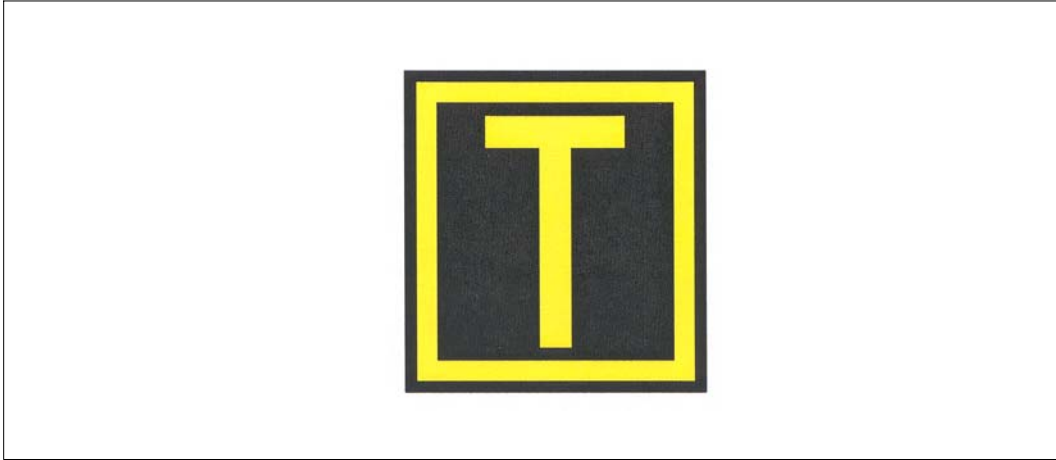
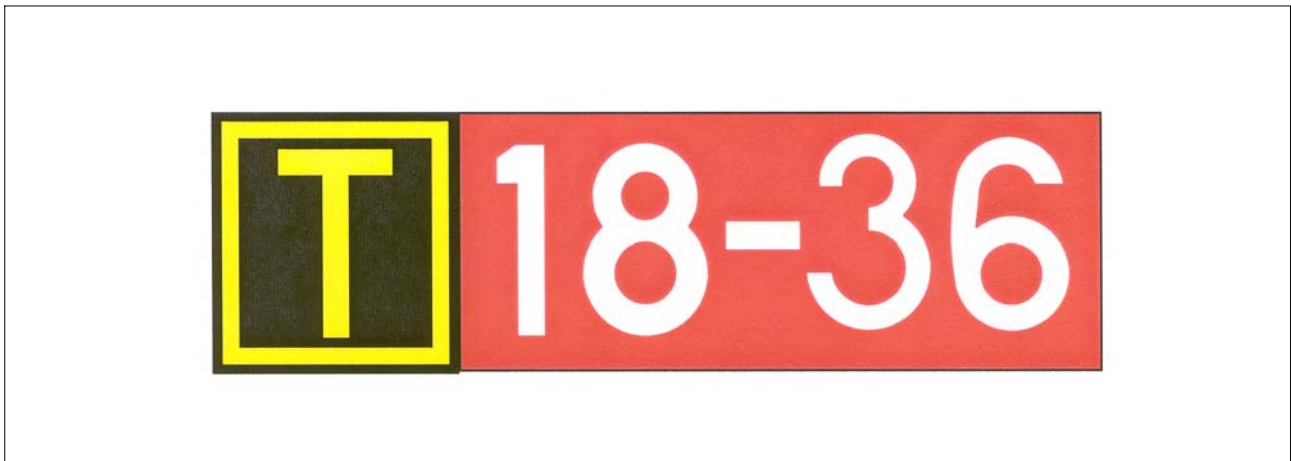

FIG 2-3-31
Taxiway Location Sign Collocated with Runway Holding Position Sign



2-3-9. Location Signs

a. Location signs are used to identify either a taxiway or runway on which the aircraft is located. Other location signs provide a visual cue to pilots to assist them in determining when they have exited an area. The various location signs are described below.

1. Taxiway Location Sign. This sign has a black background with a yellow inscription and yellow border, as shown in FIG 2-3-30. The inscription is the designation of the taxiway on which the aircraft is located. These signs are installed along taxiways either by themselves or in conjunction with direction signs or runway holding position signs. (See FIG 2-3-35 and FIG 2-3-31.)

FIG 2-3-32
Runway Location Sign



FIG 2-3-33
Runway Boundary Sign



2. Runway Location Sign. This sign has a black background with a yellow inscription and yellow border, as shown in FIG 2-3-32. The inscription is the designation of the runway on which the aircraft is located. These signs are intended to complement the information available to pilots through their magnetic compass and typically are installed where the proximity of two or more runways to one another could cause pilots to be confused as to which runway they are on.

3. Runway Boundary Sign. This sign has a yellow background with a black inscription with a graphic depicting the pavement holding position marking, as shown in FIG 2-3-33. This sign, which faces the runway and is visible to the pilot exiting the runway, is located adjacent to the holding position marking on the pavement. The sign is intended to provide pilots with another visual cue which they can use as a guide in deciding when they are “clear of the runway.”

FIG 2-3-34
ILS Critical Area Boundary Sign

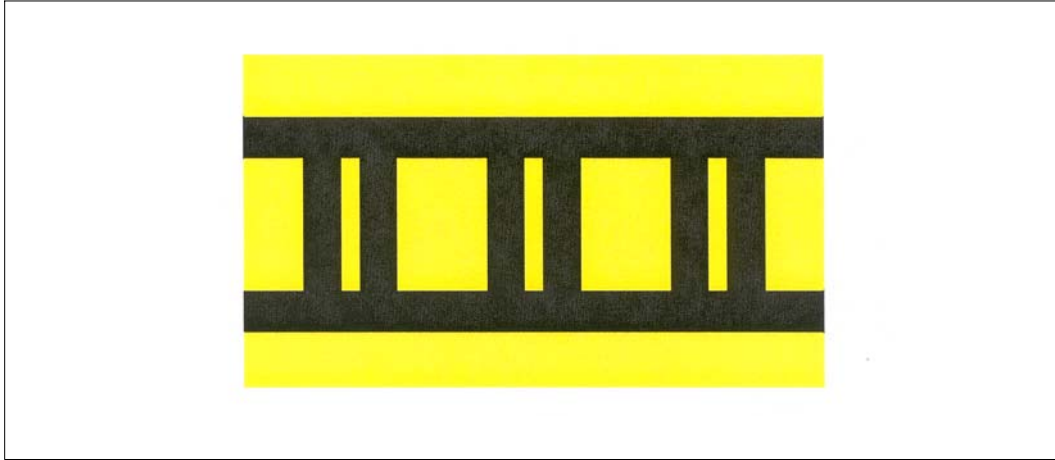

4. ILS Critical Area Boundary Sign. This sign has a yellow background with a black inscription with a graphic depicting the ILS pavement holding position marking as shown in FIG 2-3-34. This sign is located adjacent to the ILS holding position marking on the pavement and can be seen by pilots leaving the critical area. The sign is intended to provide pilots with another visual cue which they can use as a guide in deciding when they are “clear of the ILS critical area.”

2-3-10. Direction Signs

a. Direction signs have a yellow background with a black inscription. The inscription identifies the designation(s) of the intersecting taxiway(s) leading out of the intersection that a pilot would normally be expected to turn onto or hold short of. Each designation is accompanied by an arrow indicating the direction of the turn.

b. Except as noted in subparagraph e, each taxiway designation shown on the sign is accompanied by only one arrow. When more than one taxiway designation is shown on the sign, each designation and its associated arrow is separated from the other

taxiway designations by either a vertical message divider or a taxiway location sign as shown in FIG 2-3-35.

c. Direction signs are normally located on the left prior to the intersection. When used on a runway to indicate an exit, the sign is located on the same side of the runway as the exit. FIG 2-3-36 shows a direction sign used to indicate a runway exit.

d. The taxiway designations and their associated arrows on the sign are arranged clockwise starting from the first taxiway on the pilot’s left. (See FIG 2-3-35.)

e. If a location sign is located with the direction signs, it is placed so that the designations for all turns to the left will be to the left of the location sign; the designations for continuing straight ahead or for all turns to the right would be located to the right of the location sign. (See FIG 2-3-35.)

f. When the intersection is comprised of only one crossing taxiway, it is permissible to have two arrows associated with the crossing taxiway, as shown in FIG 2-3-37. In this case, the location sign is located to the left of the direction sign.

FIG 2-3-35
Direction Sign Array with Location Sign on Far Side of Intersection

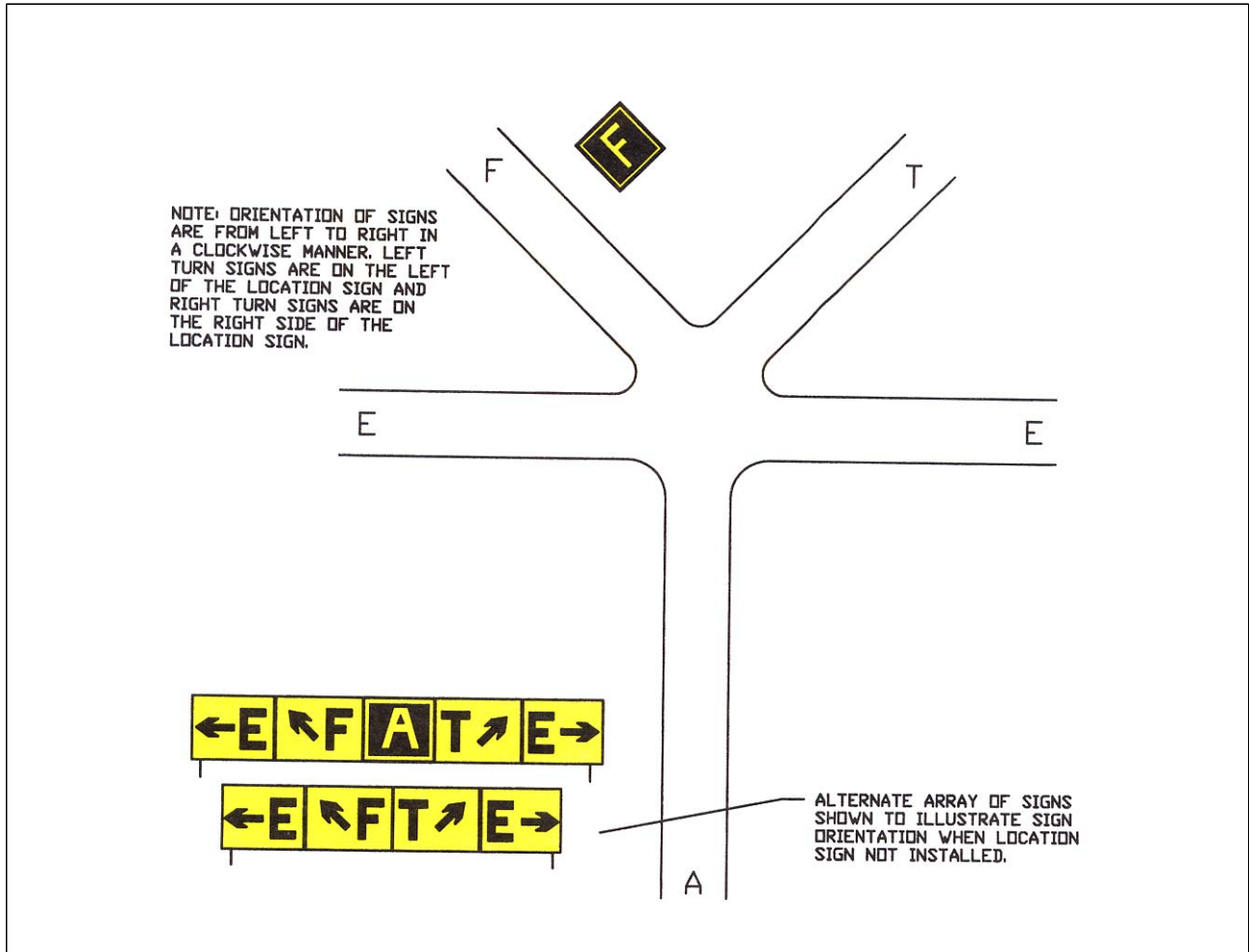

FIG 2-3-36
Direction Sign for Runway Exit



FIG 2-3-37
Direction Sign Array for Simple Intersection

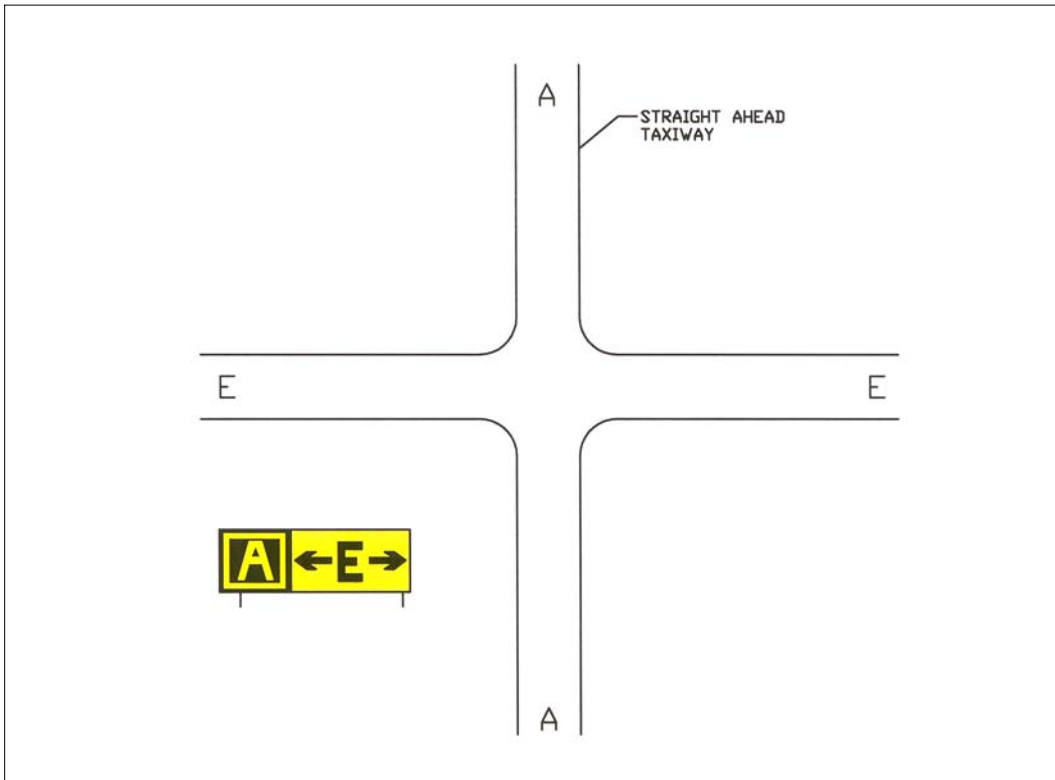

FIG 2-3-38
Destination Sign for Military Area



FIG 2-3-39
Destination Sign for Common Taxiing Route to Two Runways



2-3-11. Destination Signs

a. Destination signs also have a yellow background with a black inscription indicating a destination on the airport. These signs always have an arrow showing the direction of the taxiing route to that destination. FIG 2-3-38 is an example of a typical destination sign. When the arrow on the destination sign indicates a turn, the sign is located prior to the intersection.

b. Destinations commonly shown on these types of signs include runways, aprons, terminals, military areas, civil aviation areas, cargo areas, international

areas, and fixed base operators. An abbreviation may be used as the inscription on the sign for some of these destinations.

c. When the inscription for two or more destinations having a common taxiing route are placed on a sign, the destinations are separated by a “dot” (●) and one arrow would be used, as shown in FIG 2-3-39. When the inscription on a sign contains two or more destinations having different taxiing routes, each destination will be accompanied by an arrow and will be separated from the other destinations on the sign with a vertical black message divider, as shown in FIG 2-3-40.

FIG 2-3-40

Destination Sign for Different Taxiing Routes to Two Runways**2-3-12. Information Signs**

Information signs have a yellow background with a black inscription. They are used to provide the pilot with information on such things as areas that cannot be seen from the control tower, applicable radio frequencies, and noise abatement procedures. The airport operator determines the need, size, and location for these signs.

2-3-13. Runway Distance Remaining Signs

Runway distance remaining signs have a black background with a white numeral inscription and may be installed along one or both side(s) of the runway. The number on the signs indicates the distance (in thousands of feet) of landing runway remaining. The last sign (i.e., the sign with the numeral “1”) will be located at least 950 feet from the runway end. FIG 2-3-41 shows an example of a runway distance remaining sign.

FIG 2-3-41

Runway Distance Remaining Sign Indicating 3,000 feet of Runway Remaining

2-3-14. Aircraft Arresting Systems

a. Certain airports are equipped with a means of rapidly stopping military aircraft on a runway. This equipment, normally referred to as EMERGENCY ARRESTING GEAR, generally consists of pendant cables supported over the runway surface by rubber “donuts.” Although most devices are located in the overrun areas, a few of these arresting systems have cables stretched over the operational areas near the ends of a runway.

b. Arresting cables which cross over a runway require special markings on the runway to identify the cable location. These markings consist of 10 feet diameter solid circles painted “identification yellow,” 30 feet on center, perpendicular to the runway centerline across the entire runway width. Additional details are contained in AC 150/5220-9, Aircraft Arresting Systems for Joint Civil/Military Airports.

NOTE-

Aircraft operations on the runway are not restricted by the installation of aircraft arresting devices.

c. **Engineered Materials Arresting Systems (EMAS).** EMAS, which is constructed of high energy-absorbing materials of selected strength, is located in the safety area beyond the end of the runway. EMAS will be marked with yellow chevrons. EMAS is designed to crush under the weight of commercial aircraft and will exert deceleration forces on the landing gear. These systems do not affect the normal landing and takeoff of airplanes. More information concerning EMAS is in AC 150/5220-22, Engineered Materials Arresting Systems (EMAS) for Aircraft Overruns.

NOTE-

EMAS may be located as close as 35 feet beyond the end of the runway. Aircraft and ground vehicles should never taxi or drive across the EMAS or beyond the end of the runway if EMAS is present.

FIG 2-3-42

Engineered Materials Arresting System (EMAS)



2-3-15. Security Identification Display Area (SIDA)

a. Security Identification Display Areas (SIDA) are limited access areas that require a badge issued in accordance with procedures in 49 CFR Part 1542. A SIDA can include the Air Operations Area (AOA), e.g., aircraft movement area or parking area, or a Secured Area, such as where commercial passengers enplane. The AOA may not be a SIDA, but a Secured Area is always a SIDA. Movement through or into a SIDA is prohibited without authorization and proper identification being displayed. If you are unsure of the location of a SIDA, contact the airport authority for additional information. Airports that have a SIDA will have a description and map detailing boundaries and pertinent features available.

b. Pilots or passengers without proper identification that are observed entering a SIDA may be reported to the Transportation Security Administration (TSA) or airport security and may be subject to

civil and criminal fines and prosecution. Pilots are advised to brief passengers accordingly. Report suspicious activity to the TSA by calling AOPA's Airport Watch Program, 866-427-3287. 49 CFR 1540 requires each individual who holds an airman certificate, medical certificate, authorization, or license issued by the FAA to present it for inspection upon a request from TSA.

FIG 2-3-43

Sample SIDA Warning Sign



Chapter 3. Airspace

Section 1. General

3-1-1. General

a. There are two categories of airspace or airspace areas:

1. Regulatory (Class A, B, C, D and E airspace areas, restricted and prohibited areas); and

2. Nonregulatory (military operations areas [MOA], warning areas, alert areas, controlled firing areas [CFA], and national security areas [NSA]).

NOTE-

Additional information on special use airspace (prohibited areas, restricted areas [permanent or temporary], warning areas, MOAs [permanent or temporary], alert areas, CFAs, and NSAs) may be found in Chapter 3, Airspace, Section 4, Special Use Airspace, paragraphs 3-4-1 through 3-4-8.

b. Within these two categories, there are four types:

1. Controlled,
2. Uncontrolled,
3. Special use, and
4. Other airspace.

c. The categories and types of airspace are dictated by:

1. The complexity or density of aircraft movements,

2. The nature of the operations conducted within the airspace,

3. The level of safety required, and

4. The national and public interest.

d. It is important that pilots be familiar with the operational requirements for each of the various types or classes of airspace. Subsequent sections will cover each class in sufficient detail to facilitate understanding.

3-1-2. General Dimensions of Airspace Segments

Refer to Code of Federal Regulations (CFR) for specific dimensions, exceptions, geographical areas covered, exclusions, specific transponder or equipment requirements, and flight operations.

3-1-3. Hierarchy of Overlapping Airspace Designations

a. When overlapping airspace designations apply to the same airspace, the operating rules associated with the more restrictive airspace designation apply.

b. For the purpose of clarification:

1. Class A airspace is more restrictive than Class B, Class C, Class D, Class E, or Class G airspace;

2. Class B airspace is more restrictive than Class C, Class D, Class E, or Class G airspace;

3. Class C airspace is more restrictive than Class D, Class E, or Class G airspace;

4. Class D airspace is more restrictive than Class E or Class G airspace; and

5. Class E is more restrictive than Class G airspace.

3-1-4. Basic VFR Weather Minimums

a. No person may operate an aircraft under basic VFR when the flight visibility is less, or at a distance from clouds that is less, than that prescribed for the corresponding altitude and class of airspace. (See TBL 3-1-1.)

NOTE-

Student pilots must comply with 14 CFR Section 61.89(a) (6) and (7).

b. Except as provided in 14 CFR Section 91.157, Special VFR Weather Minimums, no person may operate an aircraft beneath the ceiling under VFR within the lateral boundaries of controlled airspace designated to the surface for an airport when the ceiling is less than 1,000 feet. (See 14 CFR Section 91.155(c).)

TBL 3-1-1
Basic VFR Weather Minimums

Airspace	Flight Visibility	Distance from Clouds
Class A	Not Applicable	Not Applicable
Class B	3 statute miles	Clear of Clouds
Class C	3 statute miles	500 feet below 1,000 feet above 2,000 feet horizontal
Class D	3 statute miles	500 feet below 1,000 feet above 2,000 feet horizontal
Class E Less than 10,000 feet MSL	3 statute miles	500 feet below 1,000 feet above 2,000 feet horizontal
At or above 10,000 feet MSL	5 statute miles	1,000 feet below 1,000 feet above 1 statute mile horizontal
Class G 1,200 feet or less above the surface (regardless of MSL altitude). For aircraft other than helicopters: Day, except as provided in §91.155(b)	1 statute mile	Clear of clouds
Night, except as provided in §91.155(b)	3 statute miles	500 feet below 1,000 feet above 2,000 feet horizontal
For helicopters: Day	½ statute mile	Clear of clouds
Night, except as provided in §91.155(b)	1 statute mile	Clear of clouds
More than 1,200 feet above the surface but less than 10,000 feet MSL. Day	1 statute mile	500 feet below 1,000 feet above 2,000 feet horizontal
Night	3 statute miles	500 feet below 1,000 feet above 2,000 feet horizontal
More than 1,200 feet above the surface and at or above 10,000 feet MSL.	5 statute miles	1,000 feet below 1,000 feet above 1 statute mile horizontal

3-1-5. VFR Cruising Altitudes and Flight Levels

(See TBL 3-1-2.)

TBL 3-1-2
VFR Cruising Altitudes and Flight Levels

If your magnetic course (ground track) is:	And you are more than 3,000 feet above the surface but below 18,000 feet MSL, fly:	And you are above 18,000 feet MSL to FL 290, fly:
0° to 179°	Odd thousands MSL, plus 500 feet (3,500; 5,500; 7,500, etc.)	Odd Flight Levels plus 500 feet (FL 195; FL 215; FL 235, etc.)
180° to 359°	Even thousands MSL, plus 500 feet (4,500; 6,500; 8,500, etc.)	Even Flight Levels plus 500 feet (FL 185; FL 205; FL 225, etc.)

Section 2. Controlled Airspace

3-2-1. General

a. Controlled Airspace. A generic term that covers the different classification of airspace (Class A, Class B, Class C, Class D, and Class E airspace) and defined dimensions within which air traffic control service is provided to IFR flights and to VFR flights in accordance with the airspace classification. (See FIG 3-2-1.)

b. IFR Requirements. IFR operations in any class of controlled airspace requires that a pilot must file an IFR flight plan and receive an appropriate ATC clearance.

c. IFR Separation. Standard IFR separation is provided to all aircraft operating under IFR in controlled airspace.

d. VFR Requirements. It is the responsibility of the pilot to ensure that ATC clearance or radio communication requirements are met prior to entry

into Class B, Class C, or Class D airspace. The pilot retains this responsibility when receiving ATC radar advisories. (See 14 CFR Part 91.)

e. Traffic Advisories. Traffic advisories will be provided to all aircraft as the controller's work situation permits.

f. Safety Alerts. Safety Alerts are mandatory services and are provided to ALL aircraft. There are two types of Safety Alerts:

1. Terrain/Obstruction Alert. A Terrain/Obstruction Alert is issued when, in the controller's judgment, an aircraft's altitude places it in unsafe proximity to terrain and/or obstructions; and

2. Aircraft Conflict/Mode C Intruder Alert. An Aircraft Conflict/Mode C Intruder Alert is issued if the controller observes another aircraft which places it in an unsafe proximity. When feasible, the controller will offer the pilot an alternative course of action.

FIG 3-2-1
Airspace Classes

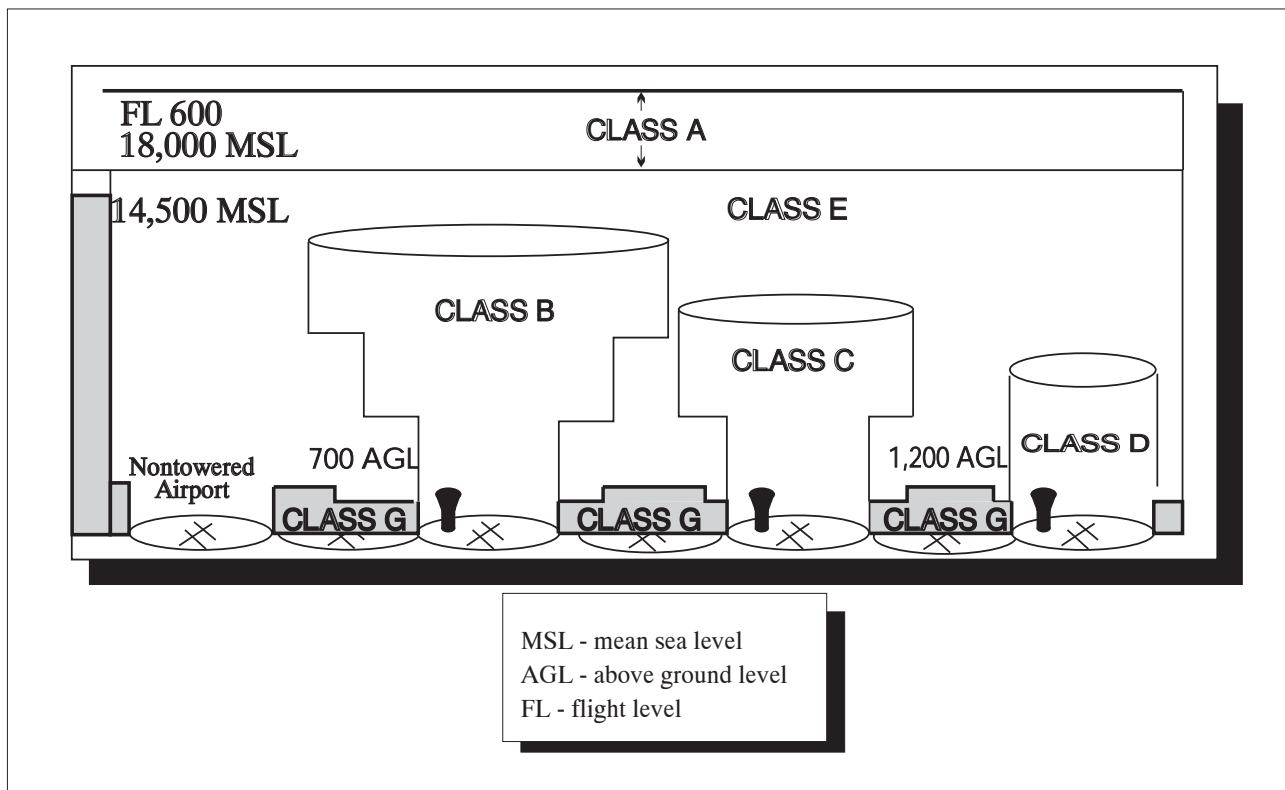

g. Ultralight Vehicles. No person may operate an ultralight vehicle within Class A, Class B, Class C, or Class D airspace or within the lateral boundaries of the surface area of Class E airspace designated for an airport unless that person has prior authorization from the ATC facility having jurisdiction over that airspace. (See 14 CFR Part 103.)

h. Unmanned Free Balloons. Unless otherwise authorized by ATC, no person may operate an unmanned free balloon below 2,000 feet above the surface within the lateral boundaries of Class B, Class C, Class D, or Class E airspace designated for an airport. (See 14 CFR Part 101.)

i. Parachute Jumps. No person may make a parachute jump, and no pilot-in-command may allow a parachute jump to be made from that aircraft, in or into Class A, Class B, Class C, or Class D airspace without, or in violation of, the terms of an ATC authorization issued by the ATC facility having jurisdiction over the airspace. (See 14 CFR Part 105.)

3-2-2. Class A Airspace

a. Definition. Generally, that airspace from 18,000 feet MSL up to and including FL 600, including the airspace overlying the waters within 12 nautical miles off the coast of the 48 contiguous States and Alaska; and designated international airspace beyond 12 nautical miles off the coast of the 48 contiguous States and Alaska within areas of domestic radio navigational signal or ATC radar coverage, and within which domestic procedures are applied.

b. Operating Rules and Pilot/Equipment Requirements. Unless otherwise authorized, all persons must operate their aircraft under IFR. (See 14 CFR Section 71.33 and 14 CFR Section 91.167 through 14 CFR Section 91.193.)

c. Charts. Class A airspace is not specifically charted.

3-2-3. Class B Airspace

a. Definition. Generally, that airspace from the surface to 10,000 feet MSL surrounding the nation's busiest airports in terms of IFR operations or passenger enplanements. The configuration of each Class B airspace area is individually tailored and

consists of a surface area and two or more layers (some Class B airspace areas resemble upside-down wedding cakes), and is designed to contain all published instrument procedures once an aircraft enters the airspace. An ATC clearance is required for all aircraft to operate in the area, and all aircraft that are so cleared receive separation services within the airspace. The cloud clearance requirement for VFR operations is "clear of clouds."

b. Operating Rules and Pilot/Equipment Requirements for VFR Operations. Regardless of weather conditions, an ATC clearance is required prior to operating within Class B airspace. Pilots should not request a clearance to operate within Class B airspace unless the requirements of 14 CFR Section 91.215 and 14 CFR Section 91.131 are met. Included among these requirements are:

1. Unless otherwise authorized by ATC, aircraft must be equipped with an operable two-way radio capable of communicating with ATC on appropriate frequencies for that Class B airspace.

2. No person may take off or land a civil aircraft at the following primary airports within Class B airspace unless the pilot-in-command holds at least a private pilot certificate:

- (a) Andrews Air Force Base, MD
- (b) Atlanta Hartsfield Airport, GA
- (c) Boston Logan Airport, MA
- (d) Chicago O'Hare Intl. Airport, IL
- (e) Dallas/Fort Worth Intl. Airport, TX
- (f) Los Angeles Intl. Airport, CA
- (g) Miami Intl. Airport, FL
- (h) Newark Intl. Airport, NJ
- (i) New York Kennedy Airport, NY
- (j) New York La Guardia Airport, NY
- (k) Ronald Reagan Washington National Airport, DC
- (l) San Francisco Intl. Airport, CA

3. No person may take off or land a civil aircraft at an airport within Class B airspace or operate a civil aircraft within Class B airspace unless:

(a) The pilot-in-command holds at least a private pilot certificate; or

(b) The aircraft is operated by a student pilot or recreational pilot who seeks private pilot certification and has met the requirements of 14 CFR Section 61.95.

4. Unless otherwise authorized by ATC, each person operating a large turbine engine-powered airplane to or from a primary airport must operate at or above the designated floors while within the lateral limits of Class B airspace.

5. Unless otherwise authorized by ATC, each aircraft must be equipped as follows:

(a) For IFR operations, an operable VOR or TACAN receiver or an operable and suitable RNAV system; and

(b) For all operations, a two-way radio capable of communications with ATC on appropriate frequencies for that area; and

(c) Unless otherwise authorized by ATC, an operable radar beacon transponder with automatic altitude reporting equipment.

NOTE—

ATC may, upon notification, immediately authorize a deviation from the altitude reporting equipment requirement; however, a request for a deviation from the 4096 transponder equipment requirement must be submitted to the controlling ATC facility at least one hour before the proposed operation.

REFERENCE—

AIM, Paragraph 4-1-20, Transponder Operation

6. Mode C Veil. The airspace within 30 nautical miles of an airport listed in Appendix D, Section 1 of 14 CFR Part 91 (generally primary airports within Class B airspace areas), from the surface upward to 10,000 feet MSL. Unless otherwise authorized by ATC, aircraft operating within this airspace must be equipped with automatic pressure altitude reporting equipment having Mode C capability.

However, an aircraft that was not originally certificated with an engine-driven electrical system or which has not subsequently been certified with a system installed may conduct operations within a Mode C veil provided the aircraft remains outside Class A, B or C airspace; and below the altitude of the ceiling of a Class B or Class C airspace area designated for an airport or 10,000 feet MSL, whichever is lower.

c. Charts. Class B airspace is charted on Sectional Charts, IFR En Route Low Altitude, and Terminal Area Charts.

d. Flight Procedures.

1. Flights. Aircraft within Class B airspace are required to operate in accordance with current IFR procedures. A clearance for a visual approach to a primary airport is not authorization for turbine-powered airplanes to operate below the designated floors of the Class B airspace.

2. VFR Flights.

(a) Arriving aircraft must obtain an ATC clearance prior to entering Class B airspace and must contact ATC on the appropriate frequency, and in relation to geographical fixes shown on local charts. Although a pilot may be operating beneath the floor of the Class B airspace on initial contact, communications with ATC should be established in relation to the points indicated for spacing and sequencing purposes.

(b) Departing aircraft require a clearance to depart Class B airspace and should advise the clearance delivery position of their intended altitude and route of flight. ATC will normally advise VFR aircraft when leaving the geographical limits of the Class B airspace. Radar service is not automatically terminated with this advisory unless specifically stated by the controller.

(c) Aircraft not landing or departing the primary airport may obtain an ATC clearance to transit the Class B airspace when traffic conditions permit and provided the requirements of 14 CFR Section 91.131 are met. Such VFR aircraft are encouraged, to the extent possible, to operate at altitudes above or below the Class B airspace or transit through established VFR corridors. Pilots operating in VFR corridors are urged to use frequency 122.750 MHz for the exchange of aircraft position information.

e. ATC Clearances and Separation. An ATC clearance is required to enter and operate within Class B airspace. VFR pilots are provided sequencing and separation from other aircraft while operating within Class B airspace.

REFERENCE—

AIM, Paragraph 4-1-18, Terminal Radar Services for VFR Aircraft

NOTE—

1. Separation and sequencing of VFR aircraft will be suspended in the event of a radar outage as this service is dependent on radar. The pilot will be advised that the service is not available and issued wind, runway information and the time or place to contact the tower.

2. Separation of VFR aircraft will be suspended during CENRAP operations. Traffic advisories and sequencing to the primary airport will be provided on a workload permitting basis. The pilot will be advised when center radar presentation (CENRAP) is in use.

1. VFR aircraft are separated from all VFR/IFR aircraft which weigh 19,000 pounds or less by a minimum of:

- (a) Target resolution, or
- (b) 500 feet vertical separation, or
- (c) Visual separation.

2. VFR aircraft are separated from all VFR/IFR aircraft which weigh more than 19,000 and turbojets by no less than:

- (a) 1 1/2 miles lateral separation, or
- (b) 500 feet vertical separation, or
- (c) Visual separation.

3. This program is not to be interpreted as relieving pilots of their responsibilities to see and avoid other traffic operating in basic VFR weather conditions, to adjust their operations and flight path as necessary to preclude serious wake encounters, to maintain appropriate terrain and obstruction clearance or to remain in weather conditions equal to or better than the minimums required by 14 CFR Section 91.155. Approach control should be advised and a revised clearance or instruction obtained when compliance with an assigned route, heading and/or altitude is likely to compromise pilot responsibility with respect to terrain and obstruction clearance, vortex exposure, and weather minimums.

4. ATC may assign altitudes to VFR aircraft that do not conform to 14 CFR Section 91.159. **“RESUME APPROPRIATE VFR ALTITUDES”** will be broadcast when the altitude assignment is no longer needed for separation or when leaving Class B airspace. Pilots must return to an altitude that conforms to 14 CFR Section 91.159.

f. Proximity operations. VFR aircraft operating in proximity to Class B airspace are cautioned against

operating too closely to the boundaries, especially where the floor of the Class B airspace is 3,000 feet or less above the surface or where VFR cruise altitudes are at or near the floor of higher levels. Observance of this precaution will reduce the potential for encountering an aircraft operating at the altitudes of Class B floors. Additionally, VFR aircraft are encouraged to utilize the VFR Planning Chart as a tool for planning flight in proximity to Class B airspace. Charted VFR Flyway Planning Charts are published on the back of the existing VFR Terminal Area Charts.

3-2-4. Class C Airspace

a. Definition. Generally, that airspace from the surface to 4,000 feet above the airport elevation (charted in MSL) surrounding those airports that have an operational control tower, are serviced by a radar approach control, and that have a certain number of IFR operations or passenger enplanements. Although the configuration of each Class C airspace area is individually tailored, the airspace usually consists of a 5 NM radius core surface area that extends from the surface up to 4,000 feet above the airport elevation, and a 10 NM radius shelf area that extends no lower than 1,200 feet up to 4,000 feet above the airport elevation.

b. Charts. Class C airspace is charted on Sectional Charts, IFR En Route Low Altitude, and Terminal Area Charts where appropriate.

c. Operating Rules and Pilot/Equipment Requirements:

1. Pilot Certification. No specific certification required.

2. Equipment.

(a) Two-way radio; and

(b) Unless otherwise authorized by ATC, an operable radar beacon transponder with automatic altitude reporting equipment.

NOTE—

See paragraph 4-1-20, *Transponder Operation, subparagraph f2(c) for Mode C transponder requirements for operating above Class C airspace.*

3. Arrival or Through Flight Entry Requirements. Two-way radio communication must be established with the ATC facility providing ATC services prior to entry and thereafter maintain those communications while in Class C airspace. Pilots of

arriving aircraft should contact the Class C airspace ATC facility on the publicized frequency and give their position, altitude, radar beacon code, destination, and request Class C service. Radio contact should be initiated far enough from the Class C airspace boundary to preclude entering Class C airspace before two-way radio communications are established.

NOTE—

1. *If the controller responds to a radio call with, “(aircraft callsign) standby,” radio communications have been established and the pilot can enter the Class C airspace.*

2. *If workload or traffic conditions prevent immediate provision of Class C services, the controller will inform the pilot to remain outside the Class C airspace until conditions permit the services to be provided.*

3. *It is important to understand that if the controller responds to the initial radio call without using the aircraft identification, radio communications have not been established and the pilot may not enter the Class C airspace.*

4. *Though not requiring regulatory action, Class C airspace areas have a procedural Outer Area. Normally this area is 20 NM from the primary Class C airspace airport. Its vertical limit extends from the lower limits of radio/radar coverage up to the ceiling of the approach control’s delegated airspace, excluding the Class C airspace itself, and other airspace as appropriate. (This outer area is not charted.)*

5. *Pilots approaching an airport with Class C service should be aware that if they descend below the base altitude of the 5 to 10 mile shelf during an instrument or visual approach, they may encounter nontransponder, VFR aircraft.*

EXAMPLE—

1. *[Aircraft callsign] “remain outside the Class Charlie airspace and standby.”*

2. *“Aircraft calling Dulles approach control, standby.”*

4. Departures from:

(a) A primary or satellite airport with an operating control tower. Two-way radio communications must be established and maintained with the control tower, and thereafter as instructed by ATC while operating in Class C airspace.

(b) A satellite airport without an operating control tower. Two-way radio communications must be established as soon as practicable after departing with the ATC facility having jurisdiction over the Class C airspace.

5. Aircraft Speed. Unless otherwise authorized or required by ATC, no person may operate an aircraft at or below 2,500 feet above the surface within 4 nautical miles of the primary airport of a Class C airspace area at an indicated airspeed of more than 200 knots (230 mph).

d. Air Traffic Services. When two-way radio communications and radar contact are established, all VFR aircraft are:

1. Sequenced to the primary airport.

2. Provided Class C services within the Class C airspace and the outer area.

3. Provided basic radar services beyond the outer area on a workload permitting basis. This can be terminated by the controller if workload dictates.

e. Aircraft Separation. Separation is provided within the Class C airspace and the outer area after two-way radio communications and radar contact are established. VFR aircraft are separated from IFR aircraft within the Class C airspace by any of the following:

1. Visual separation.

2. 500 feet vertical separation.

3. Target resolution.

4. Wake turbulence separation will be provided to all aircraft operating:

(a) Behind and less than 1,000 feet below super or heavy aircraft,

(b) To small aircraft operating behind and less than 500 feet below B757 aircraft, and

(c) To small aircraft following a large aircraft on final approach.

NOTE—

1. *Separation and sequencing of VFR aircraft will be suspended in the event of a radar outage as this service is dependent on radar. The pilot will be advised that the service is not available and issued wind, runway information and the time or place to contact the tower.*

2. *Separation of VFR aircraft will be suspended during CENRAP operations. Traffic advisories and sequencing to the primary airport will be provided on a workload permitting basis. The pilot will be advised when CENRAP is in use.*

3. *Pilot participation is voluntary within the outer area and can be discontinued, within the outer area, at the pilot’s request. Class C services will be provided in the outer area unless the pilot requests termination of the service.*

4. Some facilities provide Class C services only during published hours. At other times, terminal IFR radar service will be provided. It is important to note that the communications and transponder requirements are dependent of the class of airspace established outside of the published hours.

f. Secondary Airports

1. In some locations Class C airspace may overlie the Class D surface area of a secondary airport. In order to allow that control tower to provide service to aircraft, portions of the overlapping Class C airspace may be procedurally excluded when the secondary airport tower is in operation. Aircraft operating in these procedurally excluded areas will only be provided airport traffic control services when in communication with the secondary airport tower.

2. Aircraft proceeding inbound to a satellite airport will be terminated at a sufficient distance to allow time to change to the appropriate tower or advisory frequency. Class C services to these aircraft will be discontinued when the aircraft is instructed to contact the tower or change to advisory frequency.

3. Aircraft departing secondary controlled airports will not receive Class C services until they have been radar identified and two-way communications have been established with the Class C airspace facility.

4. This program is not to be interpreted as relieving pilots of their responsibilities to see and avoid other traffic operating in basic VFR weather conditions, to adjust their operations and flight path as necessary to preclude serious wake encounters, to maintain appropriate terrain and obstruction clearance or to remain in weather conditions equal to or better than the minimums required by 14 CFR Section 91.155. Approach control should be advised and a revised clearance or instruction obtained when compliance with an assigned route, heading and/or altitude is likely to compromise pilot responsibility with respect to terrain and obstruction clearance, vortex exposure, and weather minimums.

g. Class C Airspace Areas by State

These states currently have designated Class C airspace areas that are depicted on sectional charts. Pilots should consult current sectional charts and NOTAMs for the latest information on services available. Pilots should be aware that some Class C

airspace underlies or is adjacent to Class B airspace. (See TBL 3-2-1.)

TBL 3-2-1
Class C Airspace Areas by State

State/City	Airport
ALABAMA	
Birmingham	Birmingham–Shuttlesworth International
Huntsville	International–Carl T Jones Fld
Mobile	Regional
ALASKA	
Anchorage	Ted Stevens International
ARIZONA	
Davis–Monthan	AFB
Tucson	International
ARKANSAS	
Fayetteville (Springdale)	Northwest Arkansas Regional
Little Rock	Adams Field
CALIFORNIA	
Beale	AFB
Burbank	Bob Hope
Fresno	Yosemite International
Monterey	Peninsula
Oakland	Metropolitan Oakland International
Ontario	International
Riverside	March AFB
Sacramento	International
San Jose	Norman Y. Mineta International
Santa Ana	John Wayne/Orange County
Santa Barbara	Municipal
COLORADO	
Colorado Springs	Municipal
CONNECTICUT	
Windsor Locks	Bradley International
FLORIDA	
Daytona Beach	International
Fort Lauderdale	Hollywood International
Fort Myers	SW Florida Regional
Jacksonville	International
Orlando	Sanford International
Palm Beach	International
Pensacola	NAS
Pensacola	Regional
Sarasota	Bradenton International
Tallahassee	Regional
Whiting	NAS
GEORGIA	
Savannah	Hilton Head International
HAWAII	
Kahului	Kahului
IDAHO	
Boise	Air Terminal
ILLINOIS	
Champaign	Urbana U of Illinois–Willard

State/City	Airport
Chicago	Midway International
Moline	Quad City International
Peoria	Greater Peoria Regional
Springfield	Abraham Lincoln Capital
INDIANA	
Evansville	Regional
Fort Wayne	International
Indianapolis	International
South Bend	Regional
IOWA	
Cedar Rapids	The Eastern Iowa
Des Moines	International
KANSAS	
Wichita	Mid-Continent
KENTUCKY	
Lexington	Blue Grass
Louisville	International-Standiford Field
LOUISIANA	
Baton Rouge	Metropolitan, Ryan Field
Lafayette	Regional
Shreveport	Barksdale AFB
Shreveport	Regional
MAINE	
Bangor	International
Portland	International Jetport
MICHIGAN	
Flint	Bishop International
Grand Rapids	Gerald R. Ford International
Lansing	Capital City
MISSISSIPPI	
Columbus	AFB
Jackson	Jackson-Evers International
MISSOURI	
Springfield	Springfield-Branson National
MONTANA	
Billings	Logan International
NEBRASKA	
Lincoln	Lincoln
Omaha	Eppley Airfield
Offutt	AFB
NEVADA	
Reno	Reno/Tahoe International
NEW HAMPSHIRE	
Manchester	Manchester
NEW JERSEY	
Atlantic City	International
NEW MEXICO	
Albuquerque	International Sunport
NEW YORK	
Albany	International
Buffalo	Niagara International
Islip	Long Island MacArthur
Rochester	Greater Rochester International
Syracuse	Hancock International

State/City	Airport
NORTH CAROLINA	
Asheville	Regional
Fayetteville	Regional/Grannis Field
Greensboro	Piedmont Triad International
Pope	AFB
Raleigh	Raleigh-Durham International
OHIO	
Akron	Akron-Canton Regional
Columbus	Port Columbus International
Dayton	James M. Cox International
Toledo	Express
OKLAHOMA	
Oklahoma City	Will Rogers World
Tinker	AFB
Tulsa	International
OREGON	
Portland	International
PENNSYLVANIA	
Allentown	Lehigh Valley International
PUERTO RICO	
San Juan	Luis Munoz Marin International
RHODE ISLAND	
Providence	Theodore Francis Green State
SOUTH CAROLINA	
Charleston	AFB/International
Columbia	Metropolitan
Greer	Greenville-Spartanburg International
Myrtle Beach	Myrtle Beach International
Shaw	AFB
TENNESSEE	
Chattanooga	Lovell Field
Knoxville	McGhee Tyson
Nashville	International
TEXAS	
Abilene	Regional
Amarillo	Rick Husband International
Austin	Austin-Bergstrom International
Corpus Christi	International
Dyess	AFB
El Paso	International
Harlingen	Valley International
Laughlin	AFB
Lubbock	Preston Smith International
Midland	International
San Antonio	International
VERMONT	
Burlington	International
VIRGIN ISLANDS	
St. Thomas	Charlotte Amalie Cyril E. King
VIRGINIA	
Richmond	International
Norfolk	International

State/City	Airport
Roanoke	Regional/Woodrum Field
WASHINGTON	
Point Roberts	Vancouver International
Spokane	Fairchild AFB
Spokane	International
Whidbey Island	NAS, Ault Field
WEST VIRGINIA	
Charleston	Yeager
WISCONSIN	
Green Bay	Austin Straubel International
Madison	Dane County Regional–Traux Field
Milwaukee	General Mitchell International

3–2–5. Class D Airspace

a. Definition. Generally, Class D airspace extends upward from the surface to 2,500 feet above the airport elevation (charted in MSL) surrounding those airports that have an operational control tower. The configuration of each Class D airspace area is individually tailored and when instrument procedures are published, the airspace will normally be designed to contain the procedures.

1. Class D surface areas may be designated as full-time (24 hour tower operations) or part-time. Part-time Class D effective times are published in the Chart Supplement U.S.

2. Where a Class D surface area is part-time, the airspace may revert to either a Class E surface area (see paragraph 3–2–6e1) or Class G airspace. When a part-time Class D surface area changes to Class G, the surface area becomes Class G airspace up to, but not including, the overlying controlled airspace.

NOTE–

1. The airport listing in the Chart Supplement U.S. will state the part-time surface area status (for example, “other times CLASS E” or “other times CLASS G”).

2. Normally, the overlying controlled airspace is the Class E transition area airspace that begins at either 700 feet AGL (charted as magenta vignette) or 1200 feet AGL (charted as blue vignette). This may be determined by consulting the applicable VFR Sectional or Terminal Area Charts.

b. Operating Rules and Pilot/Equipment Requirements:

1. **Pilot Certification.** No specific certification required.

2. **Equipment.** Unless otherwise authorized by ATC, an operable two-way radio is required.

3. **Arrival or Through Flight Entry Requirements.** Two-way radio communication must be established with the ATC facility providing ATC services prior to entry and thereafter maintain those communications while in the Class D airspace. Pilots of arriving aircraft should contact the control tower on the publicized frequency and give their position, altitude, destination, and any request(s). Radio contact should be initiated far enough from the Class D airspace boundary to preclude entering the Class D airspace before two-way radio communications are established.

NOTE–

1. If the controller responds to a radio call with, “[aircraft callsign] standby,” radio communications have been established and the pilot can enter the Class D airspace.

2. If workload or traffic conditions prevent immediate entry into Class D airspace, the controller will inform the pilot to remain outside the Class D airspace until conditions permit entry.

EXAMPLE–

1. “[Aircraft callsign] remain outside the Class Delta airspace and standby.”

It is important to understand that if the controller responds to the initial radio call without using the aircraft callsign, radio communications have not been established and the pilot may not enter the Class D airspace.

2. “Aircraft calling Manassas tower standby.”

At those airports where the control tower does not operate 24 hours a day, the operating hours of the tower will be listed on the appropriate charts and in the Chart Supplement U.S. During the hours the tower is not in operation, the Class E surface area rules or a combination of Class E rules to 700 feet above ground level and Class G rules to the surface will become applicable. Check the Chart Supplement U.S. for specifics.

4. Departures from:

(a) A primary or satellite airport with an operating control tower. Two-way radio communications must be established and maintained with the control tower, and thereafter as instructed by ATC while operating in the Class D airspace.

(b) A satellite airport without an operating control tower. Two-way radio communications must be established as soon as practicable after departing with the ATC facility having jurisdiction over the Class D airspace as soon as practicable after departing.

5. Aircraft Speed. Unless otherwise authorized or required by ATC, no person may operate an aircraft at or below 2,500 feet above the surface within 4 nautical miles of the primary airport of a Class D airspace area at an indicated airspeed of more than 200 knots (230 mph).

c. Class D airspace areas are depicted on Sectional and Terminal charts with blue segmented lines, and on IFR En Route Lows with a boxed [D].

d. Surface area arrival extensions:

1. Class D surface area arrival extensions for instrument approach procedures may be Class D or Class E airspace. As a general rule, if all extensions are 2 miles or less, they remain part of the Class D surface area. However, if any one extension is greater than 2 miles, then all extensions will be Class E airspace.

2. Surface area arrival extensions are effective during the published times of the surface area. For part-time Class D surface areas that revert to Class E airspace, the arrival extensions will remain in effect as Class E airspace. For part-time Class D surface areas that change to Class G airspace, the arrival extensions will become Class G at the same time.

e. Separation for VFR Aircraft. No separation services are provided to VFR aircraft.

3-2-6. Class E Airspace

a. Definition. Class E airspace is controlled airspace that is designated to serve a variety of terminal or en route purposes as described in this paragraph.

b. Operating Rules and Pilot/Equipment Requirements:

1. Pilot Certification. No specific certification required.

2. Equipment. No specific equipment required by the airspace.

3. Arrival or Through Flight Entry Requirements. No specific requirements.

c. Charts. Class E airspace below 14,500 feet MSL is charted on Sectional, Terminal, and IFR Enroute Low Altitude charts.

d. Vertical limits. Except where designated at a lower altitude (see paragraph 3-2-6e, below, for

specifics), Class E airspace in the United States consists of:

1. The airspace extending upward from 14,500 feet MSL to, but not including, 18,000 feet MSL overlying the 48 contiguous states, the District of Columbia and Alaska, including the waters within nautical 12 miles from the coast of the 48 contiguous states and Alaska; excluding:

(a) The Alaska peninsula west of longitude 160°00'00"W.; and

(b) The airspace below 1,500 feet above the surface of the earth unless specifically designated lower (for example, in mountainous terrain higher than 13,000 feet MSL).

2. The airspace above FL 600 is Class E airspace.

e. Functions of Class E Airspace. Class E airspace may be designated for the following purposes:

1. Surface area designated for an airport where a control tower is not in operation. Class E surface areas extend upward from the surface to a designated altitude, or to the adjacent or overlying controlled airspace. The airspace will be configured to contain all instrument procedures.

(a) To qualify for a Class E surface area, the airport must have weather observation and reporting capability, and communications capability must exist with aircraft down to the runway surface.

(b) A Class E surface area may also be designated to accommodate part-time operations at a Class C or Class D airspace location (for example, those periods when the control tower is not in operation).

(c) Pilots should refer to the airport page in the applicable Chart Supplement U.S. for surface area status information.

2. Extension to a surface area. Class E airspace may be designated as extensions to Class B, Class C, Class D, and Class E surface areas. Class E airspace extensions begin at the surface and extend up to the overlying controlled airspace. The extensions provide controlled airspace to contain standard instrument approach procedures without imposing a communications requirement on pilots operating under VFR. Surface area arrival extensions become part of the surface area and are in effect during the same times as the surface area.

NOTE–

When a Class C or Class D surface area is not in effect continuously (for example, where a control tower only operates part-time), the surface area airspace will change to either a Class E surface area or Class G airspace. In such cases, the “Airspace” entry for the airport in the Chart Supplement U.S. will state “other times Class E” or “other times Class G.” When a part-time surface area changes to Class E airspace, the Class E arrival extensions will remain in effect as Class E airspace. If a part-time Class C, Class D, or Class E surface area becomes Class G airspace, the arrival extensions will change to Class G at the same time.

3. Airspace used for transition. Class E airspace areas may be designated for transitioning aircraft to/from the terminal or en route environment.

(a) Class E transition areas extend upward from either 700 feet AGL (shown as magenta vignette on sectional charts) or 1,200 feet AGL (blue vignette) and are designated for airports with an approved instrument procedure.

(b) The 700-foot/1200-foot AGL Class E airspace transition areas remain in effect continuously, regardless of airport operating hours or surface area status.

NOTE–

Do not confuse the 700-foot and 1200-foot Class E transition areas with surface areas or surface area extensions.

4. En Route Domestic Areas. There are Class E airspace areas that extend upward from a specified altitude and are en route domestic airspace areas that provide controlled airspace in those areas where there is a requirement to provide IFR en route

ATC services but the Federal airway system is inadequate.

5. Federal Airways and Low-Altitude RNAV Routes. Federal airways and low-altitude RNAV routes are Class E airspace areas and, unless otherwise specified, extend upward from 1,200 feet AGL to, but not including, 18,000 feet MSL.

(a) Federal airways consist of Low/Medium Frequency (L/MF) airways (colored Federal airways) and VOR Federal airways.

(1) L/MF airways are based on non-directional beacons (NDB) and are identified as green, red, amber, or blue.

(2) VOR Federal airways are based on VOR/VORTAC facilities and are identified by a “V” prefix.

(b) Low-altitude RNAV routes consist of T-routes and helicopter RNAV routes (TK-routes).

NOTE–

See AIM Paragraph 5-3-4, Airways and Route Systems, for more details and charting information.

6. Offshore Airspace Areas. There are Class E airspace areas that extend upward from a specified altitude to, but not including, 18,000 feet MSL and are designated as offshore airspace areas. These areas provide controlled airspace beyond 12 miles from the coast of the U.S. in those areas where there is a requirement to provide IFR en route ATC services and within which the U.S. is applying domestic procedures.

f. Separation for VFR Aircraft. No separation services are provided to VFR aircraft.

Section 3. Class G Airspace

3-3-1. General

Class G airspace (uncontrolled) is that portion of airspace that has not been designated as Class A, Class B, Class C, Class D, or Class E airspace.

3-3-2. VFR Requirements

Rules governing VFR flight have been adopted to assist the pilot in meeting the responsibility to see and avoid other aircraft. Minimum flight visibility and distance from clouds required for VFR flight are contained in 14 CFR Section 91.155.

(See TBL 3-1-1.)

3-3-3. IFR Requirements

a. Title 14 CFR specifies the pilot and aircraft equipment requirements for IFR flight. Pilots are reminded that in addition to altitude or flight level requirements, 14 CFR Section 91.177 includes a requirement to remain at least 1,000 feet (2,000 feet in designated mountainous terrain) above the highest obstacle within a horizontal distance of 4 nautical miles from the course to be flown.

b. IFR Altitudes.
(See TBL 3-3-1.)

TBL 3-3-1
IFR Altitudes
Class G Airspace

If your magnetic course (ground track) is:	And you are below 18,000 feet MSL, fly:
0° to 179°	Odd thousands MSL, (3,000; 5,000; 7,000, etc.)
180° to 359°	Even thousands MSL, (2,000; 4,000; 6,000, etc.)

Section 4. Special Use Airspace

3-4-1. General

a. Special use airspace (SUA) consists of that airspace wherein activities must be confined because of their nature, or wherein limitations are imposed upon aircraft operations that are not a part of those activities, or both. SUA areas are depicted on aeronautical charts, except for controlled firing areas (CFA), temporary military operations areas (MOA), and temporary restricted areas.

b. Prohibited and restricted areas are regulatory special use airspace and are established in 14 CFR Part 73 through the rulemaking process.

c. Warning areas, MOAs, alert areas, CFAs, and national security areas (NSA) are nonregulatory special use airspace.

d. Special use airspace descriptions (except CFAs) are contained in FAA Order JO 7400.8, Special Use Airspace.

e. Permanent SUA (except CFAs) is charted on Sectional Aeronautical, VFR Terminal Area, and applicable En Route charts, and include the hours of operation, altitudes, and the controlling agency.

NOTE-

For temporary restricted areas and temporary MOAs, pilots should review the Notices to Airman Publication (NTAP), the FAA SUA website, and/or contact the appropriate overlying ATC facility to determine the effect of non-depicted SUA areas along their routes of flight.

3-4-2. Prohibited Areas

Prohibited areas contain airspace of defined dimensions identified by an area on the surface of the earth within which the flight of aircraft is prohibited. Such areas are established for security or other reasons associated with the national welfare. These areas are published in the Federal Register and are depicted on aeronautical charts.

3-4-3. Restricted Areas

a. Restricted areas contain airspace identified by an area on the surface of the earth within which the flight of aircraft, while not wholly prohibited, is subject to restrictions. Activities within these areas must be confined because of their nature or

limitations imposed upon aircraft operations that are not a part of those activities or both. Restricted areas denote the existence of unusual, often invisible, hazards to aircraft such as artillery firing, aerial gunnery, or guided missiles. Penetration of restricted areas without authorization from the using or controlling agency may be extremely hazardous to the aircraft and its occupants. Restricted areas are published in the Federal Register and constitute 14 CFR Part 73.

b. ATC facilities apply the following procedures when aircraft are operating on an IFR clearance (including those cleared by ATC to maintain VFR-on-top) via a route which lies within joint-use restricted airspace.

1. If the restricted area is not active and has been released to the controlling agency (FAA), the ATC facility will allow the aircraft to operate in the restricted airspace without issuing specific clearance for it to do so.

2. If the restricted area is active and has not been released to the controlling agency (FAA), the ATC facility will issue a clearance which will ensure the aircraft avoids the restricted airspace unless it is on an approved altitude reservation mission or has obtained its own permission to operate in the airspace and so informs the controlling facility.

NOTE-

The above apply only to joint-use restricted airspace and not to prohibited and nonjoint-use airspace. For the latter categories, the ATC facility will issue a clearance so the aircraft will avoid the restricted airspace unless it is on an approved altitude reservation mission or has obtained its own permission to operate in the airspace and so informs the controlling facility.

c. Permanent restricted areas are charted on Sectional Aeronautical, VFR Terminal Area, and the appropriate En Route charts.

NOTE-

Temporary restricted areas are not charted.

3-4-4. Warning Areas

A warning area is airspace of defined dimensions, extending from three nautical miles outward from the coast of the U.S., that contains activity that may be hazardous to nonparticipating aircraft. The purpose

of such warning areas is to warn nonparticipating pilots of the potential danger. A warning area may be located over domestic or international waters or both.

3-4-5. Military Operations Areas

a. MOAs consist of airspace of defined vertical and lateral limits established for the purpose of separating certain military training activities from IFR traffic. Whenever a MOA is being used, nonparticipating IFR traffic may be cleared through a MOA if IFR separation can be provided by ATC. Otherwise, ATC will reroute or restrict nonparticipating IFR traffic.

b. Examples of activities conducted in MOAs include, but are not limited to: air combat tactics, air intercepts, aerobatics, formation training, and low-altitude tactics. Military pilots flying in an active MOA are exempted from the provisions of 14 CFR Section 91.303(c) and (d) which prohibits aerobatic flight within Class D and Class E surface areas, and within Federal airways. Additionally, the Department of Defense has been issued an authorization to operate aircraft at indicated airspeeds in excess of 250 knots below 10,000 feet MSL within active MOAs.

c. Pilots operating under VFR should exercise extreme caution while flying within a MOA when military activity is being conducted. The activity status (active/inactive) of MOAs may change frequently. Therefore, pilots should contact any FSS within 100 miles of the area to obtain accurate real-time information concerning the MOA hours of operation. Prior to entering an active MOA, pilots should contact the controlling agency for traffic advisories.

d. Permanent MOAs are charted on Sectional Aeronautical, VFR Terminal Area, and the appropriate En Route Low Altitude charts.

NOTE-

Temporary MOAs are not charted.

3-4-6. Alert Areas

Alert areas are depicted on aeronautical charts to inform nonparticipating pilots of areas that may

contain a high volume of pilot training or an unusual type of aerial activity. Pilots should be particularly alert when flying in these areas. All activity within an alert area must be conducted in accordance with CFRs, without waiver, and pilots of participating aircraft as well as pilots transiting the area must be equally responsible for collision avoidance.

3-4-7. Controlled Firing Areas

CFAs contain activities which, if not conducted in a controlled environment, could be hazardous to nonparticipating aircraft. The distinguishing feature of the CFA, as compared to other special use airspace, is that its activities are suspended immediately when spotter aircraft, radar, or ground lookout positions indicate an aircraft might be approaching the area. There is no need to chart CFAs since they do not cause a nonparticipating aircraft to change its flight path.

3-4-8. National Security Areas

NSAs consist of airspace of defined vertical and lateral dimensions established at locations where there is a requirement for increased security and safety of ground facilities. Pilots are requested to voluntarily avoid flying through the depicted NSA. When it is necessary to provide a greater level of security and safety, flight in NSAs may be temporarily prohibited by regulation under the provisions of 14 CFR Section 99.7. Regulatory prohibitions will be issued by System Operations Security and disseminated via NOTAM. Inquiries about NSAs should be directed to System Operations Security.

REFERENCE-

AIM, Para 5-6-1, National Security

3-4-9. Obtaining Special Use Airspace Status

a. Pilots can request the status of SUA by contacting the using or controlling agency. The frequency for the controlling agency is tabulated in the margins of the applicable IFR and VFR charts.

b. Special Use Airspace Information Service (SUAIS) (Alaska Only). The SUAIS is a 24-hour service operated by the military that provides civilian pilots, flying VFR, with information regarding military flight operations in certain MOAs and restricted airspace within central Alaska. The service provides “near real time” information on military flight activity in the interior Alaska MOA and Restricted Area complex. SUAIS also provides

information on artillery firing, known helicopter operations, and unmanned aerial vehicle operations. Pilots flying VFR are encouraged to use SUAIS. See the Alaska Chart Supplement for hours of operation, phone numbers, and radio frequencies.

c. Special use airspace scheduling data for preflight planning is available via the FAA SUA website.

Section 5. Other Airspace Areas

3-5-1. Airport Advisory/Information Services

a. There are two advisory type services available at selected airports.

1. Local Airport Advisory (LAA) service is available only in Alaska and is operated within 10 statute miles of an airport where a control tower is not operating but where a FSS is located on the airport. At such locations, the FSS provides a complete local airport advisory service to arriving and departing aircraft. During periods of fast changing weather the FSS will automatically provide Final Guard as part of the service from the time the aircraft reports “on-final” or “taking-the-active-runway” until the aircraft reports “on-the-ground” or “airborne.”

NOTE-

Current policy, when requesting remote ATC services, requires that a pilot monitor the automated weather broadcast at the landing airport prior to requesting ATC services. The FSS automatically provides Final Guard, when appropriate, during LAA/Remote Airport Advisory (RAA) operations. Final Guard is a value added wind/altimeter monitoring service, which provides an automatic wind and altimeter check during active weather situations when the pilot reports on-final or taking the active runway. During the landing or take-off operation when the winds or altimeter are actively changing the FSS will blind broadcast significant changes when the specialist believes the change might affect the operation. Pilots should acknowledge the first wind/altimeter check but due to cockpit activity no acknowledgement is expected for the blind broadcasts. It is prudent for a pilot to report on-the-ground or airborne to end the service.

2. Remote Airport Information Service (RAIS) is provided in support of short term special events like small to medium fly-ins. The service is advertised by NOTAM D only. The FSS will not have access to a continuous readout of the current winds and altimeter; therefore, RAIS does not include weather and/or Final Guard service. However, known traffic, special event instructions, and all other services are provided.

NOTE-

The airport authority and/or manager should request RAIS support on official letterhead directly with the manager of the FSS that will provide the service at least 60 days in advance. Approval authority rests with the FSS manager and is based on workload and resource availability.

REFERENCE-

AIM, Paragraph 4-1-9, Traffic Advisory Practices at Airports Without Operating Control Towers

b. It is not mandatory that pilots participate in the Airport Advisory programs. Participation enhances safety for everyone operating around busy GA airports; therefore, everyone is encouraged to participate and provide feedback that will help improve the program.

3-5-2. Military Training Routes

a. National security depends largely on the deterrent effect of our airborne military forces. To be proficient, the military services must train in a wide range of airborne tactics. One phase of this training involves “low level” combat tactics. The required maneuvers and high speeds are such that they may occasionally make the see-and-avoid aspect of VFR flight more difficult without increased vigilance in areas containing such operations. In an effort to ensure the greatest practical level of safety for all flight operations, the Military Training Route (MTR) program was conceived.

b. The MTR program is a joint venture by the FAA and the Department of Defense (DOD). MTRs are mutually developed for use by the military for the purpose of conducting low-altitude, high-speed training. The routes above 1,500 feet AGL are developed to be flown, to the maximum extent possible, under IFR. The routes at 1,500 feet AGL and below are generally developed to be flown under VFR.

c. Generally, MTRs are established below 10,000 feet MSL for operations at speeds in excess of 250 knots. However, route segments may be defined at higher altitudes for purposes of route continuity. For example, route segments may be defined for descent, climbout, and mountainous terrain. There are IFR and VFR routes as follows:

1. IFR Military Training Routes-(IR). Operations on these routes are conducted in accordance with IFR regardless of weather conditions.

2. VFR Military Training Routes-(VR). Operations on these routes are conducted in accordance with VFR except flight visibility must be

5 miles or more; and flights must not be conducted below a ceiling of less than 3,000 feet AGL.

d. Military training routes will be identified and charted as follows:

1. Route identification.

(a) MTRs with no segment above 1,500 feet AGL must be identified by four number characters; e.g., IR1206, VR1207.

(b) MTRs that include one or more segments above 1,500 feet AGL must be identified by three number characters; e.g., IR206, VR207.

(c) Alternate IR/VR routes or route segments are identified by using the basic/principal route designation followed by a letter suffix, e.g., IR008A, VR1007B, etc.

2. Route charting.

(a) IFR Enroute Low Altitude Chart. This chart will depict all IR routes and all VR routes that accommodate operations above 1,500 feet AGL.

(b) VFR Sectional Aeronautical Charts. These charts will depict military training activities such as IR and VR information.

(c) Area Planning (AP/1B) Chart (DOD Flight Information Publication–FLIP). This chart is published by the National Geospatial–Intelligence Agency (NGA) primarily for military users and contains detailed information on both IR and VR routes.

REFERENCE–

AIM, Paragraph 9–1–5, Subparagraph a, National Geospatial–Intelligence Agency (NGA) Products

e. The FLIP contains charts and narrative descriptions of these routes. To obtain this publication contact:

Defense Logistics Agency for Aviation
Mapping Customer Operations (DLA AVN/QAM)
8000 Jefferson Davis Highway
Richmond, VA 23297–5339
Toll free phone: 1–800–826–0342
Commercial: 804–279–6500

This NGA FLIP is available for pilot briefings at FSS and many airports.

f. Nonparticipating aircraft are not prohibited from flying within an MTR; however, extreme vigilance should be exercised when conducting flight

through or near these routes. Pilots should contact FSSs within 100 NM of a particular MTR to obtain current information or route usage in their vicinity. Information available includes times of scheduled activity, altitudes in use on each route segment, and actual route width. Route width varies for each MTR and can extend several miles on either side of the charted MTR centerline. Route width information for IR and VR MTRs is also available in the FLIP AP/1B along with additional MTR (slow routes/air refueling routes) information. When requesting MTR information, pilots should give the FSS their position, route of flight, and destination in order to reduce frequency congestion and permit the FSS specialist to identify the MTR which could be a factor.

3–5–3. Temporary Flight Restrictions

a. General. This paragraph describes the types of conditions under which the FAA may impose temporary flight restrictions. It also explains which FAA elements have been delegated authority to issue a temporary flight restrictions NOTAM and lists the types of responsible agencies/offices from which the FAA will accept requests to establish temporary flight restrictions. The 14 CFR is explicit as to what operations are prohibited, restricted, or allowed in a temporary flight restrictions area. Pilots are responsible to comply with 14 CFR Sections 91.137, 91.138, 91.141 and 91.143 when conducting flight in an area where a temporary flight restrictions area is in effect, and should check appropriate NOTAMs during flight planning.

b. The purpose for establishing a temporary flight restrictions area is to:

1. Protect persons and property in the air or on the surface from an existing or imminent hazard associated with an incident on the surface when the presence of low flying aircraft would magnify, alter, spread, or compound that hazard (14 CFR Section 91.137(a)(1));

2. Provide a safe environment for the operation of disaster relief aircraft (14 CFR Section 91.137(a)(2)); or

3. Prevent an unsafe congestion of sightseeing aircraft above an incident or event which may generate a high degree of public interest (14 CFR Section 91.137(a)(3)).

4. Protect declared national disasters for humanitarian reasons in the State of Hawaii (14 CFR Section 91.138).

5. Protect the President, Vice President, or other public figures (14 CFR Section 91.141).

6. Provide a safe environment for space agency operations (14 CFR Section 91.143).

c. Except for hijacking situations, when the provisions of 14 CFR Section 91.137(a)(1) or (a)(2) are necessary, a temporary flight restrictions area will only be established by or through the area manager at the Air Route Traffic Control Center (ARTCC) having jurisdiction over the area concerned. A temporary flight restrictions NOTAM involving the conditions of 14 CFR Section 91.137(a)(3) will be issued at the direction of the service area office director having oversight of the airspace concerned. When hijacking situations are involved, a temporary flight restrictions area will be implemented through the TSA Aviation Command Center. The appropriate FAA air traffic element, upon receipt of such a request, will establish a temporary flight restrictions area under 14 CFR Section 91.137(a)(1).

d. The FAA accepts recommendations for the establishment of a temporary flight restrictions area under 14 CFR Section 91.137(a)(1) from military major command headquarters, regional directors of the Office of Emergency Planning, Civil Defense State Directors, State Governors, or other similar authority. For the situations involving 14 CFR Section 91.137(a)(2), the FAA accepts recommendations from military commanders serving as regional, subregional, or Search and Rescue (SAR) coordinators; by military commanders directing or coordinating air operations associated with disaster relief; or by civil authorities directing or coordinating organized relief air operations (includes representatives of the Office of Emergency Planning, U.S. Forest Service, and State aeronautical agencies). Appropriate authorities for a temporary flight restrictions establishment under 14 CFR Section 91.137(a)(3) are any of those listed above or by State, county, or city government entities.

e. The type of restrictions issued will be kept to a minimum by the FAA consistent with achievement of the necessary objective. Situations which warrant the extreme restrictions of 14 CFR Section 91.137(a)(1) include, but are not limited to: toxic gas leaks or

spills, flammable agents, or fumes which if fanned by rotor or propeller wash could endanger persons or property on the surface, or if entered by an aircraft could endanger persons or property in the air; imminent volcano eruptions which could endanger airborne aircraft and occupants; nuclear accident or incident; and hijackings. Situations which warrant the restrictions associated with 14 CFR Section 91.137(a)(2) include: forest fires which are being fought by releasing fire retardants from aircraft; and aircraft relief activities following a disaster (earthquake, tidal wave, flood, etc.). 14 CFR Section 91.137(a)(3) restrictions are established for events and incidents that would attract an unsafe congestion of sightseeing aircraft.

f. The amount of airspace needed to protect persons and property or provide a safe environment for rescue/relief aircraft operations is normally limited to within 2,000 feet above the surface and within a 3–nautical–mile radius. Incidents occurring within Class B, Class C, or Class D airspace will normally be handled through existing procedures and should not require the issuance of a temporary flight restrictions NOTAM. Temporary flight restrictions affecting airspace outside of the U.S. and its territories and possessions are issued with verbiage excluding that airspace outside of the 12–mile coastal limits.

g. The FSS nearest the incident site is normally the “coordination facility.” When FAA communications assistance is required, the designated FSS will function as the primary communications facility for coordination between emergency control authorities and affected aircraft. The ARTCC may act as liaison for the emergency control authorities if adequate communications cannot be established between the designated FSS and the relief organization. For example, the coordination facility may relay authorizations from the on-scene emergency response official in cases where news media aircraft operations are approved at the altitudes used by relief aircraft.

h. ATC may authorize operations in a temporary flight restrictions area under its own authority only when flight restrictions are established under 14 CFR Section 91.137(a)(2) and (a)(3). The appropriate ARTCC/airport traffic control tower manager will, however, ensure that such authorized flights do not hamper activities or interfere with the event for which restrictions were implemented. However, ATC will

not authorize local IFR flights into the temporary flight restrictions area.

i. To preclude misunderstanding, the implementing NOTAM will contain specific and formatted information. The facility establishing a temporary flight restrictions area will format a NOTAM beginning with the phrase “FLIGHT RESTRICTIONS” followed by: the location of the temporary flight restrictions area; the effective period; the area defined in statute miles; the altitudes affected; the FAA coordination facility and commercial telephone number; the reason for the temporary flight restrictions; the agency directing any relief activities and its commercial telephone number; and other information considered appropriate by the issuing authority.

EXAMPLE—

1. 14 CFR Section 91.137(a)(1):

The following NOTAM prohibits all aircraft operations except those specified in the NOTAM.

Flight restrictions Matthews, Virginia, effective immediately until 9610211200. Pursuant to 14 CFR Section 91.137(a)(1) temporary flight restrictions are in effect. Rescue operations in progress. Only relief aircraft operations under the direction of the Department of Defense are authorized in the airspace at and below 5,000 feet MSL within a 2–nautical–mile radius of Laser AFB, Matthews, Virginia. Commander, Laser AFB, in charge (897) 946–5543 (122.4). Steenson FSS (792) 555–6141 (123.1) is the FAA coordination facility.

2. 14 CFR Section 91.137(a)(2):

The following NOTAM permits flight operations in accordance with 14 CFR Section 91.137(a)(2). The on-site emergency response official to authorize media aircraft operations below the altitudes used by the relief aircraft. Flight restrictions 25 miles east of Bransome, Idaho, effective immediately until 9601202359 UTC. Pursuant to 14 CFR Section 91.137(a)(2) temporary flight restrictions are in effect within a 4–nautical–mile radius of the intersection of county roads 564 and 315 at and below 3,500 feet MSL to provide a safe environment for fire fighting aircraft operations. Davis County sheriff’s department (792) 555–8122 (122.9) is in charge of on-scene emergency response activities. Glivings FSS (792) 555–1618 (122.2) is the FAA coordination facility.

3. 14 CFR Section 91.137(a)(3):

The following NOTAM prohibits sightseeing aircraft operations.

Flight restrictions Brown, Tennessee, due to olympic activity. Effective 9606181100 UTC until 9607190200

UTC. Pursuant to 14 CFR Section 91.137(a)(3) temporary flight restrictions are in effect within a 3–nautical–mile radius of N355783/W835242 and Volunteer VORTAC 019 degree radial 3.7 DME fix at and below 2,500 feet MSL. Norton FSS (423) 555–6742 (126.6) is the FAA coordination facility.

4. 14 CFR Section 91.138:

The following NOTAM prohibits all aircraft except those operating under the authorization of the official in charge of associated emergency or disaster relief response activities, aircraft carrying law enforcement officials, aircraft carrying personnel involved in an emergency or legitimate scientific purposes, carrying properly accredited news media, and aircraft operating in accordance with an ATC clearance or instruction.

Flight restrictions Kapalua, Hawaii, effective 9605101200 UTC until 9605151500 UTC. Pursuant to 14 CFR Section 91.138 temporary flight restrictions are in effect within a 3–nautical–mile radius of N205778/W1564038 and Maui/OGG/VORTAC 275 degree radial at 14.1 nautical miles. John Doe 808–757–4469 or 122.4 is in charge of the operation. Honolulu/HNL 808–757–4470 (123.6) FSS is the FAA coordination facility.

5. 14 CFR Section 91.141:

The following NOTAM prohibits all aircraft.

Flight restrictions Stillwater, Oklahoma, June 21, 1996. Pursuant to 14 CFR Section 91.141 aircraft flight operations are prohibited within a 3–nautical–mile radius, below 2000 feet AGL of N360962/W970515 and the Stillwater/SWO/VOR/DME 176 degree radial 3.8–nautical–mile fix from 1400 local time to 1700 local time June 21, 1996, unless otherwise authorized by ATC.

6. 14 CFR Section 91.143:

The following NOTAM prohibits any aircraft of U.S. registry, or pilot any aircraft under the authority of an airman certificate issued by the FAA.

Kennedy space center space operations area effective immediately until 9610152100 UTC. Pursuant to 14 CFR Section 91.143, flight operations conducted by FAA certificated pilots or conducted in aircraft of U.S. registry are prohibited at any altitude from surface to unlimited, within the following area 30–nautical–mile radius of the Melbourne/MLB/VORTAC 010 degree radial 21–nautical–mile fix. St. Petersburg, Florida/PIE/FSS 813–545–1645 (122.2) is the FAA coordination facility and should be contacted for the current status of any airspace associated with the space shuttle operations. This airspace encompasses R2933, R2932, R2931, R2934, R2935, W497A and W158A. Additional warning and restricted areas will be active in conjunction with the operations. Pilots must consult all NOTAMs regarding this operation.

3-5-4. Parachute Jump Aircraft Operations

a. Procedures relating to parachute jump areas are contained in 14 CFR Part 105. Tabulations of parachute jump areas in the U.S. are contained in the Chart Supplement U.S.

b. Pilots of aircraft engaged in parachute jump operations are reminded that all reported altitudes must be with reference to mean sea level, or flight level, as appropriate, to enable ATC to provide meaningful traffic information.

c. Parachute operations in the vicinity of an airport without an operating control tower – there is no substitute for alertness while in the vicinity of an airport. It is essential that pilots conducting parachute operations be alert, look for other traffic, and exchange traffic information as recommended in Paragraph 4-1-9, Traffic Advisory Practices at Airports Without Operating Control Towers. In addition, pilots should avoid releasing parachutes while in an airport traffic pattern when there are other aircraft in that pattern. Pilots should make appropriate broadcasts on the designated Common Traffic Advisory Frequency (CTAF), and monitor that CTAF until all parachute activity has terminated or the aircraft has left the area. Prior to commencing a jump operation, the pilot should broadcast the

aircraft's altitude and position in relation to the airport, the approximate relative time when the jump will commence and terminate, and listen to the position reports of other aircraft in the area.

3-5-5. Published VFR Routes

Published VFR routes for transitioning around, under and through complex airspace such as Class B airspace were developed through a number of FAA and industry initiatives. All of the following terms, i.e., “VFR Flyway” “VFR Corridor” and “Class B Airspace VFR Transition Route” have been used when referring to the same or different types of routes or airspace. The following paragraphs identify and clarify the functionality of each type of route, and specify where and when an ATC clearance is required.

a. VFR Flyways.

1. VFR Flyways and their associated Flyway Planning Charts were developed from the recommendations of a National Airspace Review Task Group. A VFR Flyway is defined as a general flight path not defined as a specific course, for use by pilots in planning flights into, out of, through or near complex terminal airspace to avoid Class B airspace. An ATC clearance is NOT required to fly these routes.

FIG 3-5-1
VFR Flyway Planning Chart

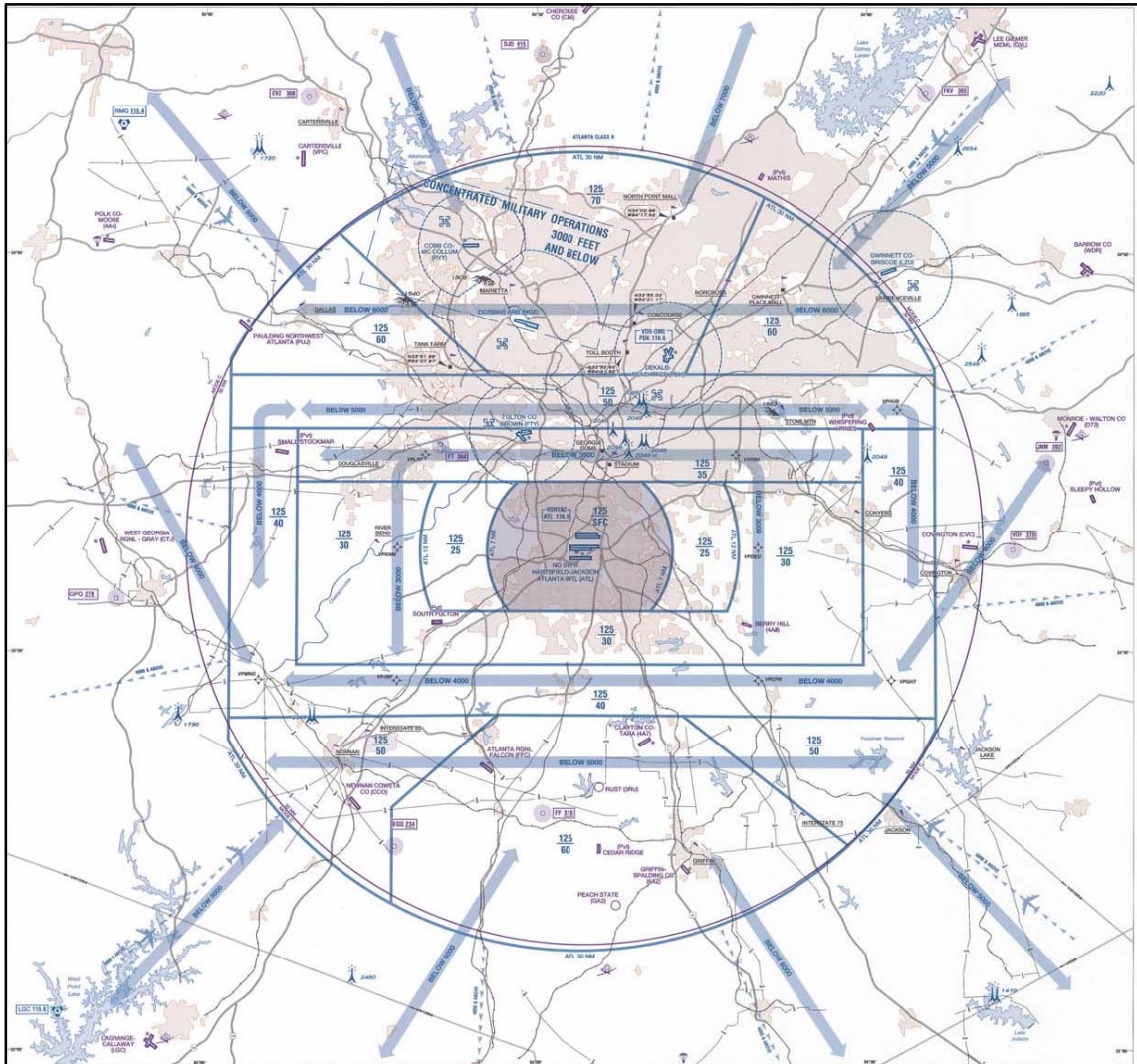

2. VFR Flyways are depicted on the reverse side of some of the VFR Terminal Area Charts (TAC), commonly referred to as Class B airspace charts. (See FIG 3-5-1.) Eventually all TACs will include a VFR Flyway Planning Chart. These charts identify VFR flyways designed to help VFR pilots avoid major controlled traffic flows. They may further depict multiple VFR routings throughout the area which may be used as an alternative to flight within Class B airspace. The ground references provide a guide for improved visual navigation. These routes are not intended to discourage requests for VFR operations within Class B airspace but are designed solely to assist pilots in planning for flights under and around busy Class B airspace without actually entering Class B airspace.

3. It is very important to remember that these suggested routes are not sterile of other traffic. The entire Class B airspace, and the airspace underneath it, may be heavily congested with many different types of aircraft. Pilot adherence to VFR rules must be exercised at all times. Further, when operating beneath Class B airspace, communications must be established and maintained between your aircraft and any control tower while transiting the Class B, Class C, and Class D surface areas of those airports under Class B airspace.

b. VFR Corridors.

1. The design of a few of the first Class B airspace areas provided a corridor for the passage of uncontrolled traffic. A VFR corridor is defined as airspace through Class B airspace, with defined vertical and lateral boundaries, in which aircraft may operate without an ATC clearance or communication with air traffic control.

2. These corridors are, in effect, a “hole” through Class B airspace. (See FIG 3-5-2.) A classic example would be the corridor through the Los Angeles Class B airspace, which has been subsequently changed to Special Flight Rules airspace (SFR). A corridor is surrounded on all sides by Class B airspace and does not extend down to the surface like a VFR Flyway. Because of their finite lateral and vertical limits, and the volume of VFR

traffic using a corridor, extreme caution and vigilance must be exercised.

FIG 3-5-2
Class B Airspace

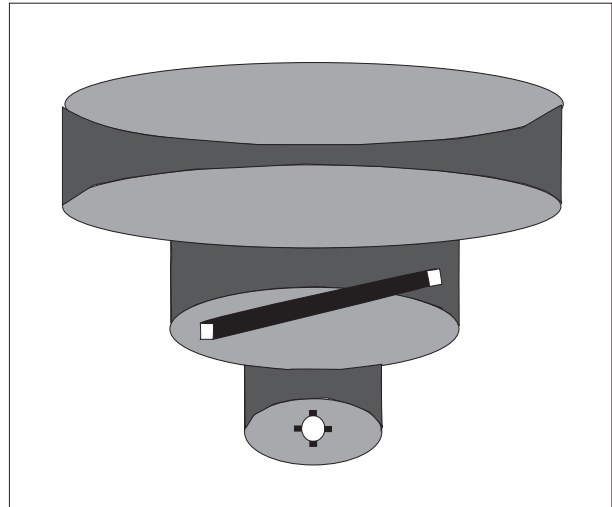

3. Because of the heavy traffic volume and the procedures necessary to efficiently manage the flow of traffic, it has not been possible to incorporate VFR corridors in the development or modifications of Class B airspace in recent years.

c. Class B Airspace VFR Transition Routes.

1. To accommodate VFR traffic through certain Class B airspace, such as Seattle, Phoenix and Los Angeles, Class B Airspace VFR Transition Routes were developed. A Class B Airspace VFR Transition Route is defined as a specific flight course depicted on a TAC for transiting a specific Class B airspace. These routes include specific ATC-assigned altitudes, and pilots must obtain an ATC clearance prior to entering Class B airspace on the route.

2. These routes, as depicted in FIG 3-5-3, are designed to show the pilot where to position the aircraft outside of, or clear of, the Class B airspace where an ATC clearance can normally be expected with minimal or no delay. Until ATC authorization is received, pilots must remain clear of Class B airspace. On initial contact, pilots should advise ATC of their position, altitude, route name desired, and direction of flight. After a clearance is received, pilots must fly the route as depicted and, most importantly, adhere to ATC instructions.

FIG 3-5-3
VFR Transition Route

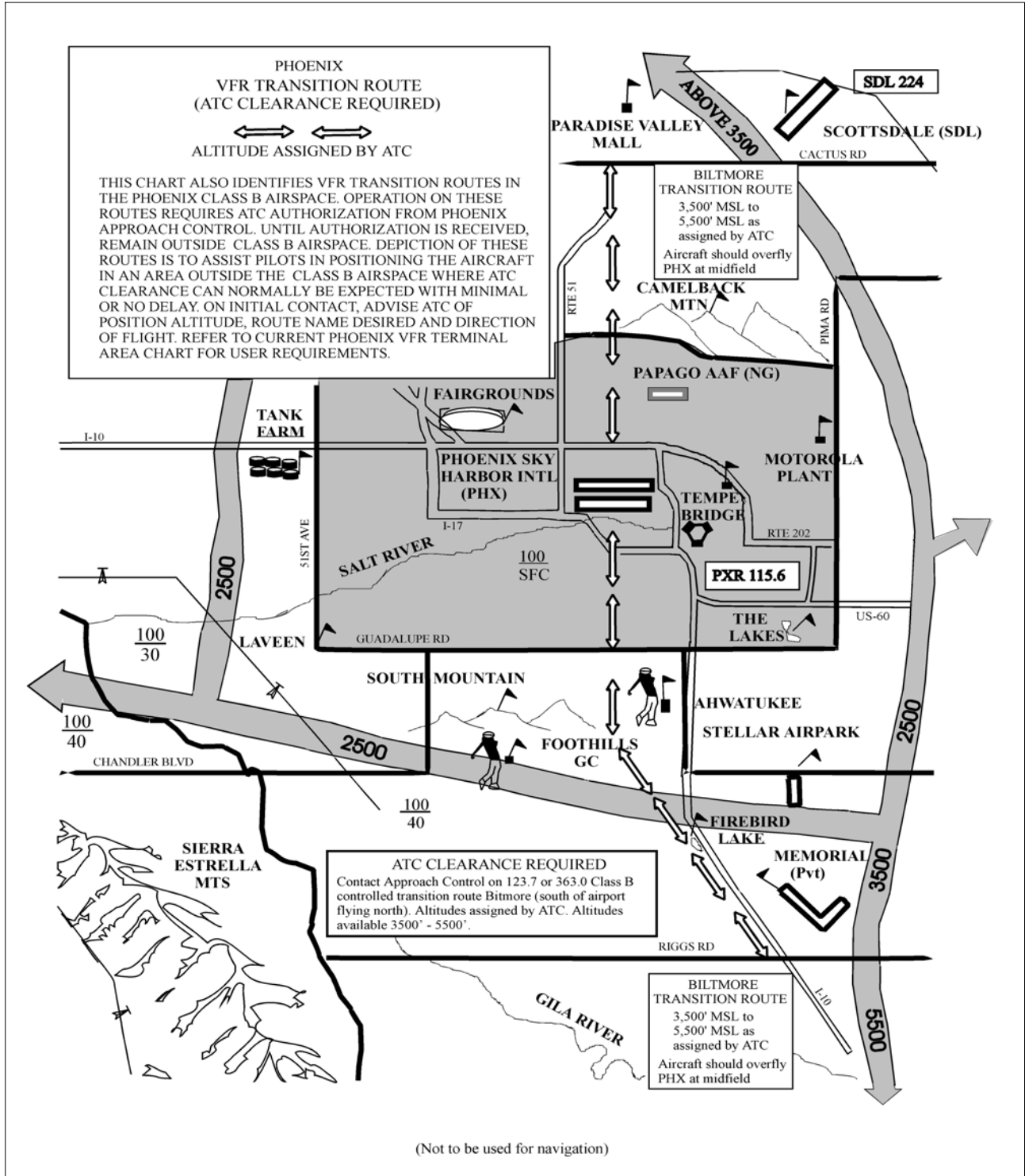

3-5-6. Terminal Radar Service Area (TRSA)

a. Background. TRSAs were originally established as part of the Terminal Radar Program at selected airports. TRSAs were never controlled airspace from a regulatory standpoint because the establishment of TRSAs was never subject to the rulemaking process; consequently, TRSAs are not contained in 14 CFR Part 71 nor are there any TRSA operating rules in 14 CFR Part 91. Part of the Airport Radar Service Area (ARSA) program was to eventually replace all TRSAs. However, the ARSA requirements became relatively stringent and it was subsequently decided that TRSAs would have to meet ARSA criteria before they would be converted. TRSAs do not fit into any of the U.S. airspace classes; therefore, they will continue to be non-Part 71 airspace areas where participating pilots can receive additional radar services which have been redefined as TRSA Service.

b. TRSAs. The primary airport(s) within the TRSA become(s) Class D airspace. The remaining portion of the TRSA overlies other controlled airspace which is normally Class E airspace beginning at 700 or 1,200 feet and established to transition to/from the en route/terminal environment.

c. Participation. Pilots operating under VFR are encouraged to contact the radar approach control and avail themselves of the TRSA Services. However, participation is voluntary on the part of the pilot. See Chapter 4, Air Traffic Control, for details and procedures.

d. Charts. TRSAs are depicted on VFR sectional and terminal area charts with a solid black line and altitudes for each segment. The Class D portion is charted with a blue segmented line.

3-5-7. Special Air Traffic Rules (SATR) and Special Flight Rules Area (SFRA)

a. Background. The Code of Federal Regulations (CFR) prescribes special air traffic rules for aircraft operating within the boundaries of certain designated airspace. These areas are listed in 14 CFR Part 93 and can be found throughout the NAS. Procedures, nature of operations, configuration, size, and density of traffic vary among the identified areas.

b. SFRAs. Airspace of defined dimensions, above land areas or territorial waters, within which the flight of aircraft is subject to the rules set forth in 14 CFR

Part 93, unless otherwise authorized by air traffic control. Not all areas listed in 14 CFR Part 93 are designated SFRA, but special air traffic rules apply to all areas described in 14 CFR Part 93.

REFERENCE-

14 CFR Part 93, Special Air Traffic Rules

FAA Order JO 7110.65, Para 9-2-10, Special Air Traffic Rules (SATR) and Special Flight Rules Area (SFRA)

PCG - Special Air Traffic Rules (SATR)

c. Participation. Each person operating an aircraft to, from, or within airspace designated as a SATR area or SFRA must adhere to the special air traffic rules set forth in 14 CFR Part 93, as applicable, unless otherwise authorized or required by ATC.

d. Charts. SFRAs are depicted on VFR sectional, terminal area, and helicopter route charts. (See FIG 3-5-4.)

FIG 3-5-4
SFRA Boundary

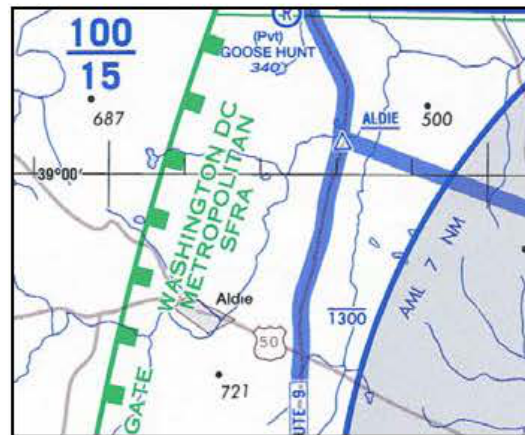

e. Additional information and resources regarding SFRA, including procedures for flight in individual areas, may be found on the FAA Safety website at www.faasafety.gov.

3-5-8. Weather Reconnaissance Area (WRA)

a. General. Hurricane Hunters from the United States Air Force Reserve 53rd Weather Reconnaissance Squadron (WRS) and the National Oceanic and Atmospheric Administration (NOAA) Aircraft Operations Center (AOC) operate weather reconnaissance/research aircraft missions, in support of the National Hurricane Operations Plan (NHOP), to gather meteorological data on hurricanes and tropical cyclones. 53rd WRS and NOAA AOC aircraft normally conduct these missions in airspace

identified in a published WRA Notice to Airmen (NOTAM).

b. WRAs. Airspace with defined dimensions and published by a NOTAM, which is established to support weather reconnaissance/research flights. ATC services are not provided within WRAs. Only participating weather reconnaissance/research aircraft from the 53rd WRS and NOAA AOC are permitted to operate within a WRA. A WRA may only be established in airspace within U. S. Flight

Information Regions (FIR) outside of U. S. territorial airspace.

c. A published WRA NOTAM describes the airspace dimensions of the WRA and the expected activities within the WRA. WRAs may border adjacent foreign FIRs, but are wholly contained within U.S. FIRs. As ATC services are not provided within a WRA, non-participating aircraft should avoid WRAs, and IFR aircraft should expect to be rerouted to avoid WRAs.

Chapter 4. Air Traffic Control

Section 1. Services Available to Pilots

4-1-1. Air Route Traffic Control Centers

Centers are established primarily to provide air traffic service to aircraft operating on IFR flight plans within controlled airspace, and principally during the en route phase of flight.

4-1-2. Control Towers

Towers have been established to provide for a safe, orderly and expeditious flow of traffic on and in the vicinity of an airport. When the responsibility has been so delegated, towers also provide for the separation of IFR aircraft in the terminal areas.

*REFERENCE—
AIM, Paragraph 5-4-3, Approach Control*

4-1-3. Flight Service Stations

Flight Service Stations (FSSs) are air traffic facilities that provide pilot briefings, flight plan processing, en route flight advisories, search and rescue services, and assistance to lost aircraft and aircraft in emergency situations. FSSs also relay ATC clearances, process Notices to Airmen, and broadcast aviation weather and aeronautical information. In Alaska, designated FSSs also provide TWEB recordings, take weather observations, and provide Airport Advisory Services (AAS).

4-1-4. Recording and Monitoring

a. Calls to air traffic control (ATC) facilities (ARTCCs, Towers, FSSs, Central Flow, and Operations Centers) over radio and ATC operational telephone lines (lines used for operational purposes such as controller instructions, briefings, opening and closing flight plans, issuance of IFR clearances and amendments, counter hijacking activities, etc.) may be monitored and recorded for operational uses such as accident investigations, accident prevention, search and rescue purposes, specialist training and evaluation, and technical evaluation and repair of control and communications systems.

b. Where the public access telephone is recorded, a beeper tone is not required. In place of the “beep”

tone the FCC has substituted a mandatory requirement that persons to be recorded be given notice they are to be recorded and give consent. Notice is given by this entry, consent to record is assumed by the individual placing a call to the operational facility.

4-1-5. Communications Release of IFR Aircraft Landing at an Airport Without an Operating Control Tower

Aircraft operating on an IFR flight plan, landing at an airport without an operating control tower will be advised to change to the airport advisory frequency when direct communications with ATC are no longer required. Towers and centers do not have nontower airport traffic and runway in use information. The instrument approach may not be aligned with the runway in use; therefore, if the information has not already been obtained, pilots should make an expeditious change to the airport advisory frequency when authorized.

*REFERENCE—
AIM, Paragraph 5-4-4, Advance Information on Instrument Approach*

4-1-6. Pilot Visits to Air Traffic Facilities

Pilots are encouraged to participate in local pilot/air traffic control outreach activities. However, due to security and workload concerns, requests for air traffic facility visits may not always be approved. Therefore, visit requests should be submitted through the air traffic facility as early as possible. Pilots should contact the facility and advise them of the number of persons in the group, the time and date of the proposed visit, and the primary interest of the group. The air traffic facility will provide further instructions if a request can be approved.

*REFERENCE—
FAA Order 1600.69, FAA Facility Security Management Program*

4-1-7. Operation Rain Check

Operation Rain Check is a program designed and managed by local air traffic control facility management. Its purpose is to familiarize pilots and aspiring pilots with the ATC system, its functions, responsibilities and benefits.

REFERENCE-

FAA Order JO 7210.3, Paragraph 4-2-2, Pilot Education
FAA Order 1600.69, FAA Facility Security Management Program

4-1-8. Approach Control Service for VFR Arriving Aircraft

a. Numerous approach control facilities have established programs for arriving VFR aircraft to contact approach control for landing information. This information includes: wind, runway, and altimeter setting at the airport of intended landing. This information may be omitted if contained in the Automatic Terminal Information Service (ATIS) broadcast and the pilot states the appropriate ATIS code.

NOTE-

Pilot use of “have numbers” does not indicate receipt of the ATIS broadcast. In addition, the controller will provide traffic advisories on a workload permitting basis.

b. Such information will be furnished upon initial contact with concerned approach control facility. The pilot will be requested to change to the *tower* frequency at a predetermined time or point, to receive further landing information.

c. Where available, use of this procedure will not hinder the operation of VFR flights by requiring excessive spacing between aircraft or devious routing.

d. Compliance with this procedure is not mandatory but pilot participation is encouraged.

REFERENCE-

AIM, Paragraph 4-1-18, Terminal Radar Services for VFR Aircraft

NOTE-

Approach control services for VFR aircraft are normally dependent on ATC radar. These services are not available during periods of a radar outage. Approach control services for VFR aircraft are limited when CENRAP is in use.

4-1-9. Traffic Advisory Practices at Airports Without Operating Control Towers

(See TBL 4-1-1.)

a. Airport Operations Without Operating Control Tower

1. There is no substitute for alertness while in the vicinity of an airport. It is essential that pilots be alert and look for other traffic and exchange traffic information when approaching or departing an

airport without an operating control tower. This is of particular importance since other aircraft may not have communication capability or, in some cases, pilots may not communicate their presence or intentions when operating into or out of such airports. To achieve the greatest degree of safety, it is essential that:

(a) All radio-equipped aircraft transmit/receive on a common frequency identified for the purpose of airport advisories; and

(b) Pilots use the correct airport name, as identified in appropriate aeronautical publications, to reduce the risk of confusion when communicating their position, intentions, and/or exchanging traffic information.

2. An airport may have a full or part-time tower or FSS located on the airport, a full or part-time UNICOM station or no aeronautical station at all. There are three ways for pilots to communicate their intention and obtain airport/traffic information when operating at an airport that does not have an operating tower: by communicating with an FSS, a UNICOM operator, or by making a self-announce broadcast.

NOTE-

FSS airport advisories are available only in Alaska.

3. Many airports are now providing completely automated weather, radio check capability and airport advisory information on an automated UNICOM system. These systems offer a variety of features, typically selectable by microphone clicks, on the UNICOM frequency. Availability of the automated UNICOM will be published in the Chart Supplement U.S. and approach charts.

b. Communicating on a Common Frequency

1. The key to communicating at an airport without an operating control tower is selection of the correct common frequency. The acronym CTAF which stands for Common Traffic Advisory Frequency, is synonymous with this program. A CTAF is a frequency designated for the purpose of carrying out airport advisory practices while operating to or from an airport without an operating control tower. The CTAF may be a UNICOM, MULTICOM, FSS, or tower frequency and is identified in appropriate aeronautical publications.

NOTE-

FSS frequencies are available only in Alaska.

TBL 4-1-1

Summary of Recommended Communication Procedures

		Communication/Broadcast Procedures			
	Facility at Airport	Frequency Use	Outbound	Inbound	Practice Instrument Approach
1.	UNICOM (No Tower or FSS)	Communicate with UNICOM station on published CTAF frequency (122.7; 122.8; 122.725; 122.975; or 123.0). If unable to contact UNICOM station, use self-announce procedures on CTAF.	Before taxiing and before taxiing on the runway for departure.	10 miles out. Entering downwind, base, and final. Leaving the runway.	
2.	No Tower, FSS, or UNICOM	Self-announce on MULTICOM frequency 122.9.	Before taxiing and before taxiing on the runway for departure.	10 miles out. Entering downwind, base, and final. Leaving the runway.	Departing final approach fix (name) or on final approach segment inbound.
3.	No Tower in operation, FSS open (Alaska only)	Communicate with FSS on CTAF frequency.	Before taxiing and before taxiing on the runway for departure.	10 miles out. Entering downwind, base, and final. Leaving the runway.	Approach completed/terminated.
4.	FSS Closed (No Tower)	Self-announce on CTAF.	Before taxiing and before taxiing on the runway for departure.	10 miles out. Entering downwind, base, and final. Leaving the runway.	
5.	Tower or FSS not in operation	Self-announce on CTAF.	Before taxiing and before taxiing on the runway for departure.	10 miles out. Entering downwind, base, and final. Leaving the runway.	
6.	Designated CTAF Area (Alaska Only)	Self-announce on CTAF designated on chart or Chart Supplement Alaska.	Before taxiing and before taxiing on the runway for departure until leaving designated area.	When entering designated CTAF area.	

2. CTAF (Alaska Only). In Alaska, a CTAF may also be designated for the purpose of carrying out advisory practices while operating in designated areas with a high volume of VFR traffic.

3. The CTAF frequency for a particular airport or area is contained in the Chart Supplement U.S., Chart Supplement Alaska, Alaska Terminal Publication, Instrument Approach Procedure Charts, and Instrument Departure Procedure (DP) Charts. Also, the CTAF frequency can be obtained by contacting any FSS. Use of the appropriate CTAF, combined with a visual alertness and application of the following recommended good operating practices, will enhance safety of flight into and out of all uncontrolled airports.

c. Recommended Traffic Advisory Practices

1. Pilots of inbound traffic should monitor and communicate as appropriate on the designated CTAF from 10 miles to landing. Pilots of departing aircraft should monitor/communicate on the appropriate frequency from start-up, during taxi, and until 10 miles from the airport unless the CFRs or local procedures require otherwise.

2. Pilots of aircraft conducting other than arriving or departing operations at altitudes normally used by arriving and departing aircraft should monitor/communicate on the appropriate frequency while within 10 miles of the airport unless required to do otherwise by the CFRs or local procedures. Such

operations include parachute jumping/dropping, en route, practicing maneuvers, etc.

3. In Alaska, pilots of aircraft conducting other than arriving or departing operations in designated CTAF areas should monitor/communicate on the appropriate frequency while within the designated area, unless required to do otherwise by CFRs or local procedures. Such operations include parachute jumping/dropping, en route, practicing maneuvers, etc.

REFERENCE-

AIM, Paragraph 3-5-4, Parachute Jump Aircraft Operations

d. Airport Advisory/Information Services Provided by a FSS

1. There are two advisory type services provided at selected airports.

(a) Local Airport Advisory (LAA) is available only in Alaska and provided at airports that have a FSS physically located on the airport, which does not have a control tower or where the tower is operated on a part-time basis. The CTAF for LAA airports is disseminated in the appropriate aeronautical publications.

(b) Remote Airport Information Service (RAIS) is provided in support of special events at nontowered airports by request from the airport authority.

2. In communicating with a CTAF FSS, check the airport's automated weather and establish two-way communications before transmitting out-bound/inbound intentions or information. An inbound aircraft should initiate contact approximately 10 miles from the airport, reporting aircraft identification and type, altitude, location relative to the airport, intentions (landing or over flight), possession of the automated weather, and request airport advisory or airport information service. A departing aircraft should initiate contact before taxiing, reporting aircraft identification and type, VFR or IFR, location on the airport, intentions, direction of take-off, possession of the automated weather, and request airport advisory or information service. Also, report intentions before taxiing onto the active runway for departure. If you must change frequencies for other service after initial report to FSS, return to FSS frequency for traffic update.

(a) Inbound

EXAMPLE-

Vero Beach radio, Centurion Six Niner Delta Delta is ten miles south, two thousand, landing Vero Beach. I have the automated weather, request airport advisory.

(b) Outbound

EXAMPLE-

Vero Beach radio, Centurion Six Niner Delta Delta, ready to taxi to runway 22, VFR, departing to the southwest. I have the automated weather, request airport advisory.

3. Airport advisory service includes wind direction and velocity, favored or designated runway, altimeter setting, known airborne and ground traffic, NOTAMs, airport taxi routes, airport traffic pattern information, and instrument approach procedures. These elements are varied so as to best serve the current traffic situation. Some airport managers have specified that under certain wind or other conditions designated runways be used. Pilots should advise the FSS of the runway they intend to use.

CAUTION-

All aircraft in the vicinity of an airport may not be in communication with the FSS.

e. Information Provided by Aeronautical Advisory Stations (UNICOM)

1. UNICOM is a nongovernment air/ground radio communication station which may provide airport information at public use airports where there is no tower or FSS.

2. On pilot request, UNICOM stations may provide pilots with weather information, wind direction, the recommended runway, or other necessary information. If the UNICOM frequency is designated as the CTAF, it will be identified in appropriate aeronautical publications.

f. Unavailability of Information from FSS or UNICOM

Should LAA by an FSS or Aeronautical Advisory Station UNICOM be unavailable, wind and weather information may be obtainable from nearby controlled airports via Automatic Terminal Information Service (ATIS) or Automated Weather Observing System (AWOS) frequency.

g. Self-Announce Position and/or Intentions

1. **General.** Self-announce is a procedure whereby pilots broadcast their position or intended flight activity or ground operation on the designated CTAF. This procedure is used primarily at airports which do not have an FSS on the airport. The

self-announce procedure should also be used if a pilot is unable to communicate with the FSS on the designated CTAF. Pilots stating, “Traffic in the area, please advise” is not a recognized Self-Announce Position and/or Intention phrase and should not be used under any condition.

2. If an airport has a tower and it is temporarily closed, or operated on a part-time basis and there is no FSS on the airport or the FSS is closed, use the CTAF to self-announce your position or intentions.

3. Where there is no tower, FSS, or UNICOM station on the airport, use MULTICOM frequency 122.9 for self-announce procedures. Such airports will be identified in appropriate aeronautical information publications.

4. **Practice Approaches.** Pilots conducting practice instrument approaches should be particularly alert for other aircraft that may be departing in the opposite direction. When conducting any practice approach, regardless of its direction relative to other airport operations, pilots should make announcements on the CTAF as follows:

(a) Departing the final approach fix, inbound (nonprecision approach) or departing the outer marker or fix used in lieu of the outer marker, inbound (precision approach);

(b) Established on the final approach segment or immediately upon being released by ATC;

(c) Upon completion or termination of the approach; and

(d) Upon executing the missed approach procedure.

5. Departing aircraft should always be alert for arrival aircraft coming from the opposite direction.

6. Recommended self-announce phraseologies: It should be noted that aircraft operating to or from another nearby airport may be making self-announce broadcasts on the same UNICOM or MULTICOM frequency. To help identify one airport from another, the airport name should be spoken at the beginning and end of each self-announce transmission.

(a) Inbound

EXAMPLE–

Strawn traffic, Apache Two Two Five Zulu, (position), (altitude), (descending) or entering downwind/base/final (as appropriate) runway one seven full stop, touch-and–

go, Strawn.

Strawn traffic Apache Two Two Five Zulu clear of runway one seven Strawn.

(b) Outbound

EXAMPLE–

Strawn traffic, Queen Air Seven One Five Five Bravo (location on airport) taxiing to runway two six Strawn.

Strawn traffic, Queen Air Seven One Five Five Bravo departing runway two six. Departing the pattern to the (direction), climbing to (altitude) Strawn.

(c) Practice Instrument Approach

EXAMPLE–

Strawn traffic, Cessna Two One Four Three Quebec (position from airport) inbound descending through (altitude) practice (name of approach) approach runway three five Strawn.

Strawn traffic, Cessna Two One Four Three Quebec practice (type) approach completed or terminated runway three five Strawn.

h. UNICOM Communications Procedures

1. In communicating with a UNICOM station, the following practices will help reduce frequency congestion, facilitate a better understanding of pilot intentions, help identify the location of aircraft in the traffic pattern, and enhance safety of flight:

(a) Select the correct UNICOM frequency.

(b) State the identification of the UNICOM station you are calling in each transmission.

(c) Speak slowly and distinctly.

(d) Report approximately 10 miles from the airport, reporting altitude, and state your aircraft type, aircraft identification, location relative to the airport, state whether landing or overflight, and request wind information and runway in use.

(e) Report on downwind, base, and final approach.

(f) Report leaving the runway.

2. Recommended UNICOM phraseologies:

(a) Inbound

PHRASEOLOGY–

FREDERICK UNICOM CESSNA EIGHT ZERO ONE TANGO FOXTROT 10 MILES SOUTHEAST DESCENDING THROUGH (altitude) LANDING FREDERICK, REQUEST WIND AND RUNWAY INFORMATION FREDERICK.

FREDERICK TRAFFIC CESSNA EIGHT ZERO ONE TANGO FOXTROT ENTERING DOWNWIND/BASE/

*FINAL (as appropriate) FOR RUNWAY ONE NINER (full stop/touch-and-go) FREDERICK.
FREDERICK TRAFFIC CESSNA EIGHT ZERO ONE TANGO FOXTROT CLEAR OF RUNWAY ONE NINER FREDERICK.*

(b) Outbound

PHRASEOLOGY-

FREDERICK UNICOM CESSNA EIGHT ZERO ONE TANGO FOXTROT (location on airport) TAXIING TO RUNWAY ONE NINER, REQUEST WIND AND TRAFFIC INFORMATION FREDERICK.

FREDERICK TRAFFIC CESSNA EIGHT ZERO ONE TANGO FOXTROT DEPARTING RUNWAY ONE NINER. "REMAINING IN THE PATTERN" OR "DEPARTING THE PATTERN TO THE (direction) (as appropriate)" FREDERICK.

4-1-10. IFR Approaches/Ground Vehicle Operations

a. IFR Approaches. When operating in accordance with an IFR clearance and ATC approves a change to the advisory frequency, make an expeditious change to the CTAF and employ the recommended traffic advisory procedures.

b. Ground Vehicle Operation. Airport ground vehicles equipped with radios should monitor the CTAF frequency when operating on the airport movement area and remain clear of runways/taxiways being used by aircraft. Radio transmissions from ground vehicles should be confined to safety-related matters.

c. Radio Control of Airport Lighting Systems. Whenever possible, the CTAF will be used to control airport lighting systems at airports without operating control towers. This eliminates the need for pilots to change frequencies to turn the lights on and allows a continuous listening watch on a single frequency. The CTAF is published on the instrument approach chart and in other appropriate aeronautical information publications. For further details concerning radio controlled lights, see AC 150/5340-27, Air-to-Ground Radio Control of Airport Lighting Systems.

4-1-11. Designated UNICOM/MULTICOM Frequencies

Frequency use

a. The following listing depicts UNICOM and MULTICOM frequency uses as designated by the Federal Communications Commission (FCC). (See TBL 4-1-2.)

*TBL 4-1-2
Unicom/Multicom Frequency Usage*

Use	Frequency
Airports without an operating control tower.	122.700
	122.725
	122.800
	122.975
	123.000
	123.050
(MULTICOM FREQUENCY) Activities of a temporary, seasonal, emergency nature or search and rescue, as well as, airports with no tower, FSS, or UNICOM.	123.075
(MULTICOM FREQUENCY)	122.900
Forestry management and fire suppression, fish and game management and protection, and environmental monitoring and protection.	122.925
Airports with a control tower or FSS on airport.	122.950

NOTE-

- In some areas of the country, frequency interference may be encountered from nearby airports using the same UNICOM frequency. Where there is a problem, UNICOM operators are encouraged to develop a "least interference" frequency assignment plan for airports concerned using the frequencies designated for airports without operating control towers. UNICOM licensees are encouraged to apply for UNICOM 25 kHz spaced channel frequencies. Due to the extremely limited number of frequencies with 50 kHz channel spacing, 25 kHz channel spacing should be implemented. UNICOM licensees may then request FCC to assign frequencies in accordance with the plan, which FCC will review and consider for approval.*
- Wind direction and runway information may not be available on UNICOM frequency 122.950.*

b. The following listing depicts other frequency uses as designated by the Federal Communications Commission (FCC). (See TBL 4-1-3.)

*TBL 4-1-3***Other Frequency Usage Designated by FCC**

Use	Frequency
Air-to-air communication (private fixed wing aircraft).	122.750
Air-to-air communications (general aviation helicopters).	123.025
Aviation instruction, Glider, Hot Air Balloon (not to be used for advisory service).	123.300 123.500

4-1-12. Use of UNICOM for ATC Purposes

UNICOM service may be used for ATC purposes, only under the following circumstances:

- a. Revision to proposed departure time.
- b. Takeoff, arrival, or flight plan cancellation time.
- c. ATC clearance, provided arrangements are made between the ATC facility and the UNICOM licensee to handle such messages.

4-1-13. Automatic Terminal Information Service (ATIS)

a. ATIS is the continuous broadcast of recorded noncontrol information in selected high activity terminal areas. Its purpose is to improve controller effectiveness and to relieve frequency congestion by automating the repetitive transmission of essential but routine information. The information is continuously broadcast over a discrete VHF radio frequency or the voice portion of a local NAVAID. Arrival ATIS transmissions on a discrete VHF radio frequency are engineered according to the individual facility requirements, which would normally be a protected service volume of 20 NM to 60 NM from the ATIS site and a maximum altitude of 25,000 feet AGL. In the case of a departure ATIS, the protected service volume cannot exceed 5 NM and 100 feet AGL. At most locations, ATIS signals may be received on the surface of the airport, but local conditions may limit the maximum ATIS reception distance and/or altitude. Pilots are urged to cooperate in the ATIS program as it relieves frequency congestion on approach control, ground control, and local control frequencies. The Chart Supplement U.S. indicates airports for which ATIS is provided.

b. ATIS information includes:

1. Airport/facility name
2. Phonetic letter code
3. Time of the latest weather sequence (UTC)
4. Weather information consisting of:
 - (a) Wind direction and velocity
 - (b) Visibility
 - (c) Obstructions to vision

(d) Present weather consisting of: sky condition, temperature, dew point, altimeter, a density altitude advisory when appropriate, and other pertinent remarks included in the official weather observation

5. Instrument approach and runway in use.

The ceiling/sky condition, visibility, and obstructions to vision may be omitted from the ATIS broadcast if the ceiling is above 5,000 feet and the visibility is more than 5 miles. The departure runway will only be given if different from the landing runway except at locations having a separate ATIS for departure. The broadcast may include the appropriate frequency and instructions for VFR arrivals to make initial contact with approach control. Pilots of aircraft arriving or departing the terminal area can receive the continuous ATIS broadcast at times when cockpit duties are least pressing and listen to as many repeats as desired. ATIS broadcast must be updated upon the receipt of any official hourly and special weather. A new recording will also be made when there is a change in other pertinent data such as runway change, instrument approach in use, etc.

EXAMPLE-

Dulles International information Sierra. One four zero zero zulu. Wind three five zero at eight. Visibility one zero. Ceiling four thousand five hundred broken. Temperature three four. Dew point two eight. Altimeter three zero one zero. ILS runway one right approach in use. Departing runway three zero. Advise on initial contact you have information sierra.

c. Pilots should listen to ATIS broadcasts whenever ATIS is in operation.

d. Pilots should notify controllers on initial contact that they have received the ATIS broadcast by repeating the alphabetical code word appended to the broadcast.

EXAMPLE–

“Information Sierra received.”

e. When a pilot acknowledges receipt of the ATIS broadcast, controllers may omit those items contained in the broadcast if they are current. Rapidly changing conditions will be issued by ATC and the ATIS will contain words as follows:

EXAMPLE–

“Latest ceiling/visibility/altimeter/wind/(other conditions) will be issued by approach control/tower.”

NOTE–

The absence of a sky condition or ceiling and/or visibility on ATIS indicates a sky condition or ceiling of 5,000 feet or above and visibility of 5 miles or more. A remark may be made on the broadcast, “the weather is better than 5000 and 5,” or the existing weather may be broadcast.

f. Controllers will issue pertinent information to pilots who do not acknowledge receipt of a broadcast or who acknowledge receipt of a broadcast which is not current.

g. To serve frequency limited aircraft, FSSs are equipped to transmit on the omnirange frequency at most en route VORs used as ATIS voice outlets. Such communication interrupts the ATIS broadcast. Pilots of aircraft equipped to receive on other FSS frequencies are encouraged to do so in order that these override transmissions may be kept to an absolute minimum.

h. While it is a good operating practice for pilots to make use of the ATIS broadcast where it is available, some pilots use the phrase “have numbers” in communications with the control tower. Use of this phrase means that the pilot has received wind, runway, and altimeter information ONLY and the tower does not have to repeat this information. It does not indicate receipt of the ATIS broadcast and should never be used for this purpose.

4-1-14. Automatic Flight Information Service (AFIS) – Alaska FSSs Only

a. AFIS is the continuous broadcast of recorded non-control information at airports in Alaska where an FSS provides local airport advisory service. Its purpose is to improve FSS specialist efficiency by reducing frequency congestion on the local airport advisory frequency.

1. The AFIS broadcast will automate the repetitive transmission of essential but routine information (for example, weather, favored runway,

braking action, airport NOTAMs, etc.). The information is continuously broadcast over a discrete VHF radio frequency (usually the ASOS frequency).

2. Use of AFIS is not mandatory, but pilots who choose to utilize two-way radio communications with the FSS are urged to listen to AFIS, as it relieves frequency congestion on the local airport advisory frequency. AFIS broadcasts are updated upon receipt of any official hourly and special weather, and changes in other pertinent data.

3. When a pilot acknowledges receipt of the AFIS broadcast, FSS specialists may omit those items contained in the broadcast if they are current. When rapidly changing conditions exist, the latest ceiling, visibility, altimeter, wind or other conditions may be omitted from the AFIS and will be issued by the FSS specialist on the appropriate radio frequency.

EXAMPLE–

“Kotzebue information ALPHA. One six five five zulu. Wind, two one zero at five; visibility two, fog; ceiling one hundred overcast; temperature minus one two, dew point minus one four; altimeter three one zero five. Altimeter in excess of three one zero zero, high pressure altimeter setting procedures are in effect. Favored runway two six. Weather in Kotzebue surface area is below V-F-R minima – an ATC clearance is required. Contact Kotzebue Radio on 123.6 for traffic advisories and advise intentions. Notice to Airmen, Hotham NDB out of service. Transcribed Weather Broadcast out of service. Advise on initial contact you have ALPHA.”

NOTE–

The absence of a sky condition or ceiling and/or visibility on Alaska FSS AFIS indicates a sky condition or ceiling of 5,000 feet or above and visibility of 5 miles or more. A remark may be made on the broadcast, “the weather is better than 5000 and 5.”

b. Pilots should listen to Alaska FSSs AFIS broadcasts whenever Alaska FSSs AFIS is in operation.

NOTE–

Some Alaska FSSs are open part time and/or seasonally.

c. Pilots should notify controllers on initial contact that they have received the Alaska FSSs AFIS broadcast by repeating the phonetic alphabetic letter appended to the broadcast.

EXAMPLE–

“Information Alpha received.”

d. While it is a good operating practice for pilots to make use of the Alaska FSS AFIS broadcast where it is available, some pilots use the phrase “have

numbers” in communications with the FSS. Use of this phrase means that the pilot has received wind, runway, and altimeter information ONLY and the Alaska FSS does not have to repeat this information. It does not indicate receipt of the AFIS broadcast and should never be used for this purpose.

4-1-15. Radar Traffic Information Service

This is a service provided by radar ATC facilities. Pilots receiving this service are advised of any radar target observed on the radar display which may be in such proximity to the position of their aircraft or its intended route of flight that it warrants their attention. This service is not intended to relieve the pilot of the responsibility for continual vigilance to see and avoid other aircraft.

a. Purpose of the Service

1. The issuance of traffic information as observed on a radar display is based on the principle of assisting and advising a pilot that a particular radar target’s position and track indicates it may intersect or pass in such proximity to that pilot’s intended flight path that it warrants attention. This is to alert the pilot to the traffic, to be on the lookout for it, and thereby be in a better position to take appropriate action should the need arise.

2. Pilots are reminded that the surveillance radar used by ATC does not provide altitude information unless the aircraft is equipped with Mode C and the radar facility is capable of displaying altitude information.

b. Provisions of the Service

1. Many factors, such as limitations of the radar, volume of traffic, controller workload and communications frequency congestion, could prevent the controller from providing this service. Controllers possess complete discretion for determining whether they are able to provide or continue to provide this service in a specific case. The controller’s reason against providing or continuing to provide the service in a particular case is not subject to question nor need it be communicated to the pilot. In other words, the provision of this service is entirely dependent upon whether controllers believe they are in a position to provide it. Traffic information is routinely provided to all aircraft operating on IFR flight plans except when the pilot declines the service, or the pilot is operating within Class A airspace. Traffic informa-

tion may be provided to flights not operating on IFR flight plans when requested by pilots of such flights.

NOTE-

Radar ATC facilities normally display and monitor both primary and secondary radar when it is available, except that secondary radar may be used as the sole display source in Class A airspace, and under some circumstances outside of Class A airspace (beyond primary coverage and in en route areas where only secondary is available). Secondary radar may also be used outside Class A airspace as the sole display source when the primary radar is temporarily unusable or out of service. Pilots in contact with the affected ATC facility are normally advised when a temporary outage occurs; i.e., “primary radar out of service; traffic advisories available on transponder aircraft only.” This means simply that only the aircraft which have transponders installed and in use will be depicted on ATC radar indicators when the primary radar is temporarily out of service.

2. When receiving VFR radar advisory service, pilots should monitor the assigned frequency at all times. This is to preclude controllers’ concern for radio failure or emergency assistance to aircraft under the controller’s jurisdiction. VFR radar advisory service does not include vectors away from conflicting traffic unless requested by the pilot. When advisory service is no longer desired, advise the controller before changing frequencies and then change your transponder code to 1200, if applicable. Pilots should also inform the controller when changing VFR cruising altitude. Except in programs where radar service is automatically terminated, the controller will advise the aircraft when radar is terminated.

NOTE-

Participation by VFR pilots in formal programs implemented at certain terminal locations constitutes pilot request. This also applies to participating pilots at those locations where arriving VFR flights are encouraged to make their first contact with the tower on the approach control frequency.

c. Issuance of Traffic Information. Traffic information will include the following concerning a target which may constitute traffic for an aircraft that is:

1. Radar identified

(a) Azimuth from the aircraft in terms of the 12 hour clock, or

(b) When rapidly maneuvering civil test or military aircraft prevent accurate issuance of traffic as in (a) above, specify the direction from an aircraft’s

position in terms of the eight cardinal compass points (N, NE, E, SE, S, SW, W, NW). This method must be terminated at the pilot's request.

- (c) Distance from the aircraft in nautical miles;
- (d) Direction in which the target is proceeding; and
- (e) Type of aircraft and altitude if known.

EXAMPLE-

Traffic 10 o'clock, 3 miles, west-bound (type aircraft and altitude, if known, of the observed traffic). The altitude may be known, by means of Mode C, but not verified with the pilot for accuracy. (To be valid for separation purposes by ATC, the accuracy of Mode C readouts must be verified. This is usually accomplished upon initial entry into the radar system by a comparison of the readout to pilot stated altitude, or the field elevation in the case of continuous readout being received from an aircraft on the airport.) When necessary to issue traffic advisories containing unverified altitude information, the controller will issue the indicated altitude of the aircraft. The pilot may upon receipt of traffic information, request a vector (heading) to avoid such traffic. The vector will be provided to the extent possible as determined by the controller provided the aircraft to be vectored is within the airspace under the jurisdiction of the controller.

2. Not radar identified

- (a) Distance and direction with respect to a fix;
- (b) Direction in which the target is proceeding; and
- (c) Type of aircraft and altitude if known.

EXAMPLE-

Traffic 8 miles south of the airport northeastbound, (type aircraft and altitude if known).

d. The examples depicted in the following figures point out the possible error in the position of this traffic when it is necessary for a pilot to apply drift correction to maintain this track. This error could also occur in the event a change in course is made at the time radar traffic information is issued.

**FIG 4-1-1
Induced Error in Position of Traffic**

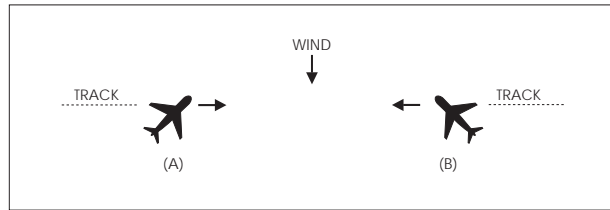

EXAMPLE-

In FIG 4-1-1 traffic information would be issued to the pilot of aircraft "A" as 12 o'clock. The actual position of the traffic as seen by the pilot of aircraft "A" would be 2 o'clock. Traffic information issued to aircraft "B" would also be given as 12 o'clock, but in this case, the pilot of "B" would see the traffic at 10 o'clock.

**FIG 4-1-2
Induced Error in Position of Traffic**

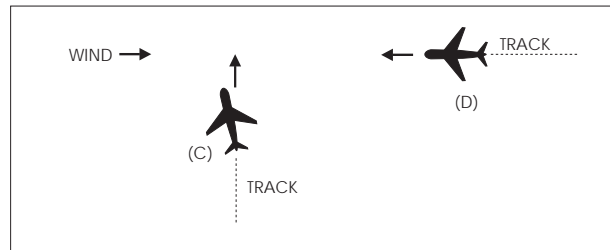

EXAMPLE-

In FIG 4-1-2 traffic information would be issued to the pilot of aircraft "C" as 2 o'clock. The actual position of the traffic as seen by the pilot of aircraft "C" would be 3 o'clock. Traffic information issued to aircraft "D" would be at an 11 o'clock position. Since it is not necessary for the pilot of aircraft "D" to apply wind correction (crab) to remain on track, the actual position of the traffic issued would be correct. Since the radar controller can only observe aircraft track (course) on the radar display, traffic advisories are issued accordingly, and pilots should give due consideration to this fact when looking for reported traffic.

4-1-16. Safety Alert

A safety alert will be issued to pilots of aircraft being controlled by ATC if the controller is aware the aircraft is at an altitude which, in the controller's judgment, places the aircraft in unsafe proximity to terrain, obstructions or other aircraft. The provision of this service is contingent upon the capability of the controller to have an awareness of a situation involving unsafe proximity to terrain, obstructions and uncontrolled aircraft. The issuance of a safety alert cannot be mandated, but it can be expected on a

reasonable, though intermittent basis. Once the alert is issued, it is solely the pilot's prerogative to determine what course of action, if any, to take. This procedure is intended for use in time critical situations where aircraft safety is in question. Noncritical situations should be handled via the normal traffic alert procedures.

a. Terrain or Obstruction Alert

1. Controllers will immediately issue an alert to the pilot of an aircraft under their control when they recognize that the aircraft is at an altitude which, in their judgment, may be in an unsafe proximity to terrain/obstructions. The primary method of detecting unsafe proximity is through Mode C automatic altitude reports.

EXAMPLE–

Low altitude alert Cessna Three Four Juliet, check your altitude immediately. And if the aircraft is not yet on final approach, the MVA (MEA/MIA/MOCA) in your area is six thousand.

2. Most En Route and Terminal radar facilities have an automated function which, if operating, alerts controllers when a tracked Mode C equipped aircraft under their control is below or is predicted to be below a predetermined minimum safe altitude. This function, called Minimum Safe Altitude Warning (MSAW), is designed solely as a controller aid in detecting potentially unsafe aircraft proximity to terrain/obstructions. The radar facility will, when MSAW is operating, provide MSAW monitoring for all aircraft with an operating Mode C altitude encoding transponder that are tracked by the system and are:

- (a) Operating on an IFR flight plan; or
- (b) Operating VFR and have requested MSAW monitoring.

3. Terminal AN/TPX-42A (number beacon decoder system) facilities have an automated function called Low Altitude Alert System (LAAS). Although not as sophisticated as MSAW, LAAS alerts the controller when a Mode C transponder equipped aircraft operating on an IFR flight plan is below a predetermined minimum safe altitude.

NOTE–

Pilots operating VFR may request MSAW or LAAS monitoring if their aircraft are equipped with Mode C transponders.

EXAMPLE–

Apache Three Three Papa request MSAW/LAAS.

4. Due to the lack of terrain and obstacle clearance data, accurate automation databases may not be available for providing MSAW information to aircraft overflying Mexico and Canada. Air traffic facilities along the United States/Mexico/Canada borders may have MSAW computer processing inhibited where accurate terrain data is not available.

b. Aircraft Conflict Alert.

1. Controllers will immediately issue an alert to the pilot of an aircraft under their control if they are aware of another aircraft which is not under their control, at an altitude which, in the controller's judgment, places both aircraft in unsafe proximity to each other. With the alert, when feasible, the controller will offer the pilot the position of the traffic if time permits and an alternate course(s) of action. Any alternate course(s) of action the controller may recommend to the pilot will be predicated only on other traffic being worked by the controller.

EXAMPLE–

American Three, traffic alert, (position of traffic, if time permits), advise you turn right/left heading (degrees) and/or climb/descend to (altitude) immediately.

4-1-17. Radar Assistance to VFR Aircraft

a. Radar equipped FAA ATC facilities provide radar assistance and navigation service (vectors) to VFR aircraft provided the aircraft can communicate with the facility, are within radar coverage, and can be radar identified.

b. Pilots should clearly understand that authorization to proceed in accordance with such radar navigational assistance does not constitute authorization for the pilot to violate CFRs. In effect, assistance provided is on the basis that navigational guidance information issued is advisory in nature and the job of flying the aircraft safely, remains with the pilot.

c. In many cases, controllers will be unable to determine if flight into instrument conditions will result from their instructions. To avoid possible hazards resulting from being vectored into IFR conditions, pilots should keep controllers advised of the weather conditions in which they are operating and along the course ahead.

d. Radar navigation assistance (vectors) may be initiated by the controller when one of the following conditions exist:

1. The controller suggests the vector and the pilot concurs.

2. A special program has been established and vectoring service has been advertised.

3. In the controller's judgment the vector is necessary for air safety.

e. Radar navigation assistance (vectors) and other radar derived information may be provided in response to pilot requests. Many factors, such as limitations of radar, volume of traffic, communications frequency, congestion, and controller workload could prevent the controller from providing it. Controllers have complete discretion for determining if they are able to provide the service in a particular case. Their decision not to provide the service in a particular case is not subject to question.

4-1-18. Terminal Radar Services for VFR Aircraft

a. Basic Radar Service:

1. In addition to the use of radar for the control of IFR aircraft, all commissioned radar facilities provide the following basic radar services for VFR aircraft:

(a) Safety alerts.

(b) Traffic advisories.

(c) Limited radar vectoring (on a workload permitting basis).

(d) Sequencing at locations where procedures have been established for this purpose and/or when covered by a Letter of Agreement.

NOTE-

When the stage services were developed, two basic radar services (traffic advisories and limited vectoring) were identified as "Stage I." This definition became unnecessary and the term "Stage I" was eliminated from use. The term "Stage II" has been eliminated in conjunction with the airspace reclassification, and sequencing services to locations with local procedures and/or letters of agreement to provide this service have been included in basic services to VFR aircraft. These basic services will still be provided by all terminal radar facilities whether they include Class B, Class C, Class D or Class E airspace. "Stage III" services have been replaced with "Class B" and "TRSA" service where applicable.

2. Vectoring service may be provided when requested by the pilot or with pilot concurrence when suggested by ATC.

3. Pilots of arriving aircraft should contact approach control on the publicized frequency and give their position, altitude, aircraft call sign, type aircraft, radar beacon code (if transponder equipped), destination, and request traffic information.

4. Approach control will issue wind and runway, except when the pilot states "have numbers" or this information is contained in the ATIS broadcast and the pilot states that the current ATIS information has been received. Traffic information is provided on a workload permitting basis. Approach control will specify the time or place at which the pilot is to contact the tower on local control frequency for further landing information. Radar service is automatically terminated and the aircraft need not be advised of termination when an arriving VFR aircraft receiving radar services to a tower-controlled airport where basic radar service is provided has landed, or to all other airports, is instructed to change to tower or advisory frequency. (See FAA Order JO 7110.65, Air Traffic Control, Paragraph 5-1-13, Radar Service Termination.)

5. Sequencing for VFR aircraft is available at certain terminal locations (see locations listed in the Chart Supplement U.S.). The purpose of the service is to adjust the flow of arriving VFR and IFR aircraft into the traffic pattern in a safe and orderly manner and to provide radar traffic information to departing VFR aircraft. Pilot participation is urged but is not mandatory. Traffic information is provided on a workload permitting basis. Standard radar separation between VFR or between VFR and IFR aircraft is not provided.

(a) Pilots of arriving VFR aircraft should initiate radio contact on the publicized frequency with approach control when approximately 25 miles from the airport at which sequencing services are being provided. On initial contact by VFR aircraft, approach control will assume that sequencing service is requested. After radar contact is established, the pilot may use pilot navigation to enter the traffic pattern or, depending on traffic conditions, approach control may provide the pilot with routings or vectors necessary for proper sequencing with other participating VFR and IFR traffic en route to the airport. When a flight is positioned behind a preceding aircraft and the pilot reports having that aircraft in

sight, the pilot will be instructed to follow the preceding aircraft. THE ATC INSTRUCTION TO FOLLOW THE PRECEDING AIRCRAFT DOES NOT AUTHORIZE THE PILOT TO COMPLY WITH ANY ATC CLEARANCE OR INSTRUCTION ISSUED TO THE PRECEDING AIRCRAFT. If other “nonparticipating” or “local” aircraft are in the traffic pattern, the tower will issue a landing sequence. If an arriving aircraft does not want radar service, the pilot should state “NEGATIVE RADAR SERVICE” or make a similar comment, on initial contact with approach control.

(b) Pilots of departing VFR aircraft are encouraged to request radar traffic information by notifying ground control, or where applicable, clearance delivery, on initial contact with their request and proposed direction of flight.

EXAMPLE—

Xray ground control, November One Eight Six, Cessna One Seventy Two, ready to taxi, VFR southbound at 2,500, have information bravo and request radar traffic information.

NOTE—

Following takeoff, the tower will advise when to contact departure control.

(c) Pilots of aircraft transiting the area and in radar contact/communication with approach control will receive traffic information on a controller workload permitting basis. Pilots of such aircraft should give their position, altitude, aircraft call sign, aircraft type, radar beacon code (if transponder equipped), destination, and/or route of flight.

b. TRSA Service (Radar Sequencing and Separation Service for VFR Aircraft in a TRSA).

1. This service has been implemented at certain terminal locations. The service is advertised in the Chart Supplement U.S. The purpose of this service is to provide separation between all participating VFR aircraft and all IFR aircraft operating within the airspace defined as the Terminal Radar Service Area (TRSA). Pilot participation is urged but is not mandatory.

2. If any aircraft does not want the service, the pilot should state “NEGATIVE TRSA SERVICE” or make a similar comment, on initial contact with approach control or ground control, as appropriate.

3. TRSAs are depicted on sectional aeronautical charts and listed in the Chart Supplement U.S.

4. While operating within a TRSA, pilots are provided TRSA service and separation as prescribed in this paragraph. In the event of a radar outage, separation and sequencing of VFR aircraft will be suspended as this service is dependent on radar. The pilot will be advised that the service is not available and issued wind, runway information, and the time or place to contact the tower. Traffic information will be provided on a workload permitting basis.

5. Visual separation is used when prevailing conditions permit and it will be applied as follows:

(a) When a VFR flight is positioned behind a preceding aircraft and the pilot reports having that aircraft in sight, the pilot will be instructed by ATC to follow the preceding aircraft. Radar service will be continued to the runway. THE ATC INSTRUCTION TO FOLLOW THE PRECEDING AIRCRAFT DOES NOT AUTHORIZE THE PILOT TO COMPLY WITH ANY ATC CLEARANCE OR INSTRUCTION ISSUED TO THE PRECEDING AIRCRAFT.

(b) If other “nonparticipating” or “local” aircraft are in the traffic pattern, the tower will issue a landing sequence.

(c) Departing VFR aircraft may be asked if they can visually follow a preceding departure out of the TRSA. The pilot will be instructed to follow the other aircraft provided that the pilot can maintain visual contact with that aircraft.

6. VFR aircraft will be separated from VFR/IFR aircraft by one of the following:

(a) 500 feet vertical separation.

(b) Visual separation.

(c) Target resolution (a process to ensure that correlated radar targets do not touch).

7. Participating pilots operating VFR in a TRSA:

(a) Must maintain an altitude when assigned by ATC unless the altitude assignment is to maintain at or below a specified altitude. ATC may assign altitudes for separation that do not conform to 14 CFR Section 91.159. When the altitude assignment is no longer needed for separation or when leaving the TRSA, the instruction will be broadcast, “RESUME APPROPRIATE VFR ALTITUDES.” Pilots must then return to an altitude that conforms to 14 CFR Section 91.159 as soon as practicable.

(b) When not assigned an altitude, the pilot should coordinate with ATC prior to any altitude change.

8. Within the TRSA, traffic information on observed but unidentified targets will, to the extent possible, be provided to all IFR and participating VFR aircraft. The pilot will be vectored upon request to avoid the observed traffic, provided the aircraft to be vectored is within the airspace under the jurisdiction of the controller.

9. Departing aircraft should inform ATC of their intended destination and/or route of flight and proposed cruising altitude.

10. ATC will normally advise participating VFR aircraft when leaving the geographical limits of the TRSA. Radar service is not automatically terminated with this advisory unless specifically stated by the controller.

c. Class C Service. This service provides, in addition to basic radar service, approved separation between IFR and VFR aircraft, and sequencing of VFR arrivals to the primary airport.

d. Class B Service. This service provides, in addition to basic radar service, approved separation of aircraft based on IFR, VFR, and/or weight, and sequencing of VFR arrivals to the primary airport(s).

e. PILOT RESPONSIBILITY. THESE SERVICES ARE NOT TO BE INTERPRETED AS RELIEVING PILOTS OF THEIR RESPONSIBILITIES TO SEE AND AVOID OTHER TRAFFIC OPERATING IN BASIC VFR WEATHER CONDITIONS, TO ADJUST THEIR OPERATIONS AND FLIGHT PATH AS NECESSARY TO PRECLUDE SERIOUS WAKE ENCOUNTERS, TO MAINTAIN APPROPRIATE TERRAIN AND OBSTRUCTION CLEARANCE, OR TO REMAIN IN WEATHER CONDITIONS EQUAL TO OR BETTER THAN THE MINIMUMS REQUIRED BY 14 CFR SECTION 91.155. WHENEVER COMPLIANCE WITH AN ASSIGNED ROUTE, HEADING AND/OR ALTITUDE IS LIKELY TO COMPROMISE PILOT RESPONSIBILITY RESPECTING TERRAIN AND OBSTRUCTION CLEARANCE, VORTEX EXPOSURE, AND WEATHER MINIMUMS, APPROACH CONTROL SHOULD BE SO ADVISED AND A REVISED CLEARANCE OR INSTRUCTION OBTAINED.

f. ATC services for VFR aircraft participating in terminal radar services are dependent on ATC radar. Services for VFR aircraft are not available during periods of a radar outage and are limited during CENRAP operations. The pilot will be advised when VFR services are limited or not available.

NOTE-

Class B and Class C airspace are areas of regulated airspace. The absence of ATC radar does not negate the requirement of an ATC clearance to enter Class B airspace or two way radio contact with ATC to enter Class C airspace.

4-1-19. Tower En Route Control (TEC)

a. TEC is an ATC program to provide a service to aircraft proceeding to and from metropolitan areas. It links designated Approach Control Areas by a network of identified routes made up of the existing airway structure of the National Airspace System. The FAA initiated an expanded TEC program to include as many facilities as possible. The program's intent is to provide an overflow resource in the low altitude system which would enhance ATC services. A few facilities have historically allowed turbojets to proceed between certain city pairs, such as Milwaukee and Chicago, via tower en route and these locations may continue this service. However, the expanded TEC program will be applied, generally, for nonturbojet aircraft operating at and below 10,000 feet. The program is entirely within the approach control airspace of multiple terminal facilities. Essentially, it is for relatively short flights. Participating pilots are encouraged to use TEC for flights of two hours duration or less. If longer flights are planned, extensive coordination may be required within the multiple complex which could result in unanticipated delays.

b. Pilots requesting TEC are subject to the same delay factor at the destination airport as other aircraft in the ATC system. In addition, departure and en route delays may occur depending upon individual facility workload. When a major metropolitan airport is incurring significant delays, pilots in the TEC program may want to consider an alternative airport experiencing no delay.

c. There are no unique requirements upon pilots to use the TEC program. Normal flight plan filing procedures will ensure proper flight plan processing. Pilots should include the acronym "TEC" in the

remarks section of the flight plan when requesting tower en route control.

d. All approach controls in the system may not operate up to the maximum TEC altitude of 10,000 feet. IFR flight may be planned to any satellite airport in proximity to the major primary airport via the same routing.

4-1-20. Transponder Operation

a. General

1. Pilots should be aware that proper application of transponder operating procedures will provide both VFR and IFR aircraft with a higher degree of safety while operating on the ground and airborne. Transponders with altitude reporting mode turned ON (Mode C or S) substantially increase the capability of surveillance systems to see an aircraft, thus providing the Air Traffic Controller increased situational awareness and the ability to identify potential traffic conflicts. Even VFR pilots who are not in contact with ATC will be afforded greater protection from IFR aircraft and VFR aircraft which are receiving traffic advisories. Nevertheless, pilots should never relax their visual scanning for other aircraft.

2. Air Traffic Control Radar Beacon System (ATCRBS) is similar to and compatible with military coded radar beacon equipment. Civil Mode A is identical to military Mode 3.

3. Transponder and ADS-B operations on the ground. Civil and military aircraft should operate with the transponder in the altitude reporting mode (consult the aircraft's flight manual to determine the specific transponder position to enable altitude reporting) and ADS-B Out transmissions enabled (if equipped) at all airports, any time the aircraft is positioned on any portion of an airport movement area. This includes all defined taxiways and runways. Pilots must pay particular attention to ATIS and airport diagram notations, General Notes (included on airport charts), and comply with directions pertaining to transponder and ADS-B usage. Generally, these directions are:

(a) Departures. Select the transponder mode which allows altitude reporting and enable ADS-B (if equipped) during pushback or taxi-out from parking spot. Select TA or TA/RA (if equipped with TCAS) when taking the active runway.

(b) Arrivals. Maintain transponder to the altitude reporting mode or if TCAS-equipped (TA or TA/RA), select the transponder to altitude reporting mode. Maintain ADS-B Out transmissions (if equipped) after clearing the active runway. Select STBY or OFF for transponder and ADS-B (if equipped) upon arriving at the aircraft's parking spot or gate.

4. Transponder and ADS-B Operations in the Air. EACH PILOT OPERATING AN AIRCRAFT EQUIPPED WITH AN OPERABLE ATC TRANSPONDER, MAINTAINED IN ACCORDANCE WITH 14 CFR SECTION 91.413 OR ADS-B TRANSMITTER, MUST OPERATE THE TRANSPONDER/TRANSMITTER, INCLUDING MODE C/S IF INSTALLED, ON THE APPROPRIATE MODE 3/A CODE OR AS ASSIGNED BY ATC. EACH PERSON OPERATING AN AIRCRAFT EQUIPPED WITH ADS-B OUT MUST OPERATE THIS EQUIPMENT IN THE TRANSMIT MODE AT ALL TIMES WHILE AIRBORNE UNLESS OTHERWISE REQUESTED BY ATC.

5. A pilot on an IFR flight who elects to cancel the IFR flight plan prior to reaching destination, should adjust the transponder according to VFR operations.

6. If entering a U.S. OFFSHORE AIRSPACE AREA from outside the U.S., the pilot should advise on first radio contact with a U.S. radar ATC facility that such equipment is available by adding "transponder" to the aircraft identification.

7. It should be noted by all users of ATC transponders and ADS-B Out systems that the surveillance coverage they can expect is limited to "line of sight" with ground radar and ADS-B radio sites. Low altitude or aircraft antenna shielding by the aircraft itself may result in reduced range or loss of aircraft contact. Surveillance coverage can be improved by climbing to a higher altitude.

NOTE-

Pilots of aircraft equipped with ADS-B should refer to AIM, Automatic Dependent Surveillance – Broadcast Services, Paragraph 4-5-7, for a complete description of operating limitations and procedures.

b. Transponder Code Designation

1. For ATC to utilize one or a combination of the 4096 discrete codes FOUR DIGIT CODE DESIGNATION will be used; for example, code 2100 will be expressed as TWO ONE ZERO ZERO. Due to the

operational characteristics of the rapidly expanding automated ATC system, THE LAST TWO DIGITS OF THE SELECTED TRANSPONDER CODE SHOULD ALWAYS READ “00” UNLESS SPECIFICALLY REQUESTED BY ATC TO BE OTHERWISE.

c. Automatic Altitude Reporting (Mode C)

1. Some transponders are equipped with a Mode C automatic altitude reporting capability. This system converts aircraft altitude in 100 foot increments to coded digital information which is transmitted together with Mode C framing pulses to the interrogating radar facility. The manner in which transponder panels are designed differs, therefore, a pilot should be thoroughly familiar with the operation of the transponder so that ATC may realize its full capabilities.

2. Adjust transponder to reply on the Mode A/3 code specified by ATC and, if equipped, to reply on Mode C with altitude reporting capability activated unless deactivation is directed by ATC or unless the installed aircraft equipment has not been tested and calibrated as required by 14 CFR Section 91.217. If deactivation is required by ATC, turn off the altitude reporting feature of your transponder. An instruction by ATC to “STOP ALTITUDE SQUAWK, ALTITUDE DIFFERS (number of feet) FEET,” may be an indication that your transponder is transmitting incorrect altitude information or that you have an incorrect altimeter setting. While an incorrect altimeter setting has no effect on the Mode C altitude information transmitted by your transponder (transponders are preset at 29.92), it would cause you to fly at an actual altitude different from your assigned altitude. When a controller indicates that an altitude readout is invalid, the pilot should initiate a check to verify that the aircraft altimeter is set correctly.

3. Pilots of aircraft with operating Mode C altitude reporting transponders should report exact altitude or flight level to the nearest hundred foot increment when establishing initial contact with an ATC facility. Exact altitude or flight level reports on initial contact provide ATC with information that is required prior to using Mode C altitude information for separation purposes. This will significantly reduce altitude verification requests.

d. Transponder IDENT Feature

1. The transponder must be operated only as specified by ATC. Activate the “IDENT” feature only upon request of the ATC controller.

e. Code Changes

1. When making routine code changes, pilots should avoid inadvertent selection of Codes 7500, 7600 or 7700 thereby causing momentary false alarms at automated ground facilities. For example, when switching from Code 2700 to Code 7200, switch first to 2200 then to 7200, NOT to 7700 and then 7200. This procedure applies to nondiscrete Code 7500 and all discrete codes in the 7600 and 7700 series (i.e., 7600–7677, 7700–7777) which will trigger special indicators in automated facilities. Only nondiscrete Code 7500 will be decoded as the hijack code.

2. Under no circumstances should a pilot of a civil aircraft operate the transponder on Code 7777. This code is reserved for military interceptor operations.

3. Military pilots operating VFR or IFR within restricted/warning areas should adjust their transponders to Code 4000 unless another code has been assigned by ATC.

f. Mode C Transponder Requirements

1. Specific details concerning requirements to carry and operate Mode C transponders, as well as exceptions and ATC authorized deviations from the requirements are found in 14 CFR Section 91.215 and 14 CFR Section 99.12.

2. In general, the CFRs require aircraft to be equipped with Mode C transponders when operating:

(a) At or above 10,000 feet MSL over the 48 contiguous states or the District of Columbia, excluding that airspace below 2,500 feet AGL;

(b) Within 30 miles of a Class B airspace primary airport, below 10,000 feet MSL. Balloons, gliders, and aircraft not equipped with an engine driven electrical system are excepted from the above requirements when operating below the floor of Class A airspace and/or; outside of a Class B airspace and below the ceiling of the Class B airspace (or 10,000 feet MSL, whichever is lower);

(c) Within and above all Class C airspace, up to 10,000 feet MSL;

(d) Within 10 miles of certain designated airports, excluding that airspace which is both outside the Class D surface area and below 1,200 feet AGL. Balloons, gliders and aircraft not equipped with an engine driven electrical system are excepted from this requirement.

3. 14 CFR Section 99.13 requires all aircraft flying into, within, or across the contiguous U.S. ADIZ be equipped with a Mode C or Mode S transponder. Balloons, gliders and aircraft not equipped with an engine driven electrical system are excepted from this requirement.

4. Pilots must ensure that their aircraft transponder is operating on an appropriate ATC assigned VFR/IFR code and Mode C when operating in such airspace. If in doubt about the operational status of either feature of your transponder while airborne, contact the nearest ATC facility or FSS and they will advise you what facility you should contact for determining the status of your equipment.

5. In-flight requests for “immediate” deviation from the transponder requirement may be approved by controllers only when the flight will continue IFR or when weather conditions prevent VFR descent and continued VFR flight in airspace not affected by the CFRs. All other requests for deviation should be made by contacting the nearest Flight Service or Air Traffic facility in person or by telephone. The nearest ARTCC will normally be the controlling agency and is responsible for coordinating requests involving deviations in other ARTCC areas.

g. Transponder Operation Under Visual Flight Rules (VFR)

1. Unless otherwise instructed by an ATC facility, adjust transponder to reply on Mode 3/A Code 1200 regardless of altitude.

NOTE—

1. *Aircraft not in contact with an ATC facility may squawk 1255 in lieu of 1200 while en route to, from, or within the designated fire fighting area(s).*

2. *VFR aircraft which fly authorized SAR missions for the USAF or USCG may be advised to squawk 1277 in lieu of 1200 while en route to, from, or within the designated search area.*

3. *Gliders not in contact with an ATC facility should squawk 1202 in lieu of 1200.*

REFERENCE—

FAA Order JO 7110.66, *National Beacon Code Allocation Plan.*

2. Adjust transponder to reply on Mode C, with altitude reporting *capability activated* if the aircraft is so equipped, unless deactivation is directed by ATC or unless the installed equipment has not been tested and calibrated as required by 14 CFR Section 91.217. If deactivation is required and your transponder is so designed, turn off the altitude reporting switch and continue to transmit Mode C framing pulses. If this capability does not exist, turn off Mode C.

h. Radar Beacon Phraseology

Air traffic controllers, both civil and military, will use the following phraseology when referring to operation of the Air Traffic Control Radar Beacon System (ATCRBS). Instructions by ATC refer only to Mode A/3 or Mode C operation and do not affect the operation of the transponder on other Modes.

1. **SQUAWK (number).** Operate radar beacon transponder on designated code in Mode A/3.

2. **IDENT.** Engage the “IDENT” feature (military I/P) of the transponder.

3. **SQUAWK (number) and IDENT.** Operate transponder on specified code in Mode A/3 and engage the “IDENT” (military I/P) feature.

4. **SQUAWK STANDBY.** Switch transponder to standby position.

5. **SQUAWK LOW/NORMAL.** Operate transponder on low or normal sensitivity as specified. Transponder is operated in “NORMAL” position unless ATC specifies “LOW” (“ON” is used instead of “NORMAL” as a master control label on some types of transponders.)

6. **SQUAWK ALTITUDE.** Activate Mode C with automatic altitude reporting.

7. **STOP ALTITUDE SQUAWK.** Turn off altitude reporting switch and continue transmitting Mode C framing pulses. If your equipment does not have this capability, turn off Mode C.

8. **STOP SQUAWK (mode in use).** Switch off specified mode. (Used for military aircraft when the controller is unaware of military service requirements for the aircraft to continue operation on another Mode.)

9. **STOP SQUAWK.** Switch off transponder.

10. **SQUAWK MAYDAY.** Operate transponder in the emergency position (Mode A Code 7700 for civil transponder. Mode 3 Code 7700 and emergency feature for military transponder.)

11. SQUAWK VFR. Operate radar beacon transponder on Code 1200 in the Mode A/3, or other appropriate VFR code.

4-1-21. Airport Reservation Operations and Special Traffic Management Programs

This section describes procedures for obtaining required airport reservations at airports designated by the FAA and for airports operating under Special Traffic Management Programs.

a. Slot Controlled Airports.

1. The FAA may adopt rules to require advance operations for unscheduled operations at certain airports. In addition to the information in the rules adopted by the FAA, a listing of the airports and relevant information will be maintained on the FAA website listed below.

2. The FAA has established an Airport Reservation Office (ARO) to receive and process reservations for unscheduled flights at the slot controlled airports. The ARO uses the Enhanced Computer Voice Reservation System (e-CVRS) to allocate reservations. Reservations will be available beginning 72 hours in advance of the operation at the slot controlled airport. Standby lists are not maintained. Flights with declared emergencies do not require reservations. Refer to the website or touch-tone phone interface for the current listing of slot controlled airports, limitations, and reservation procedures.

NOTE-

The web interface/telephone numbers to obtain a reservation for unscheduled operations at a slot controlled airport are:

1. <http://www.fly.faa.gov/ecvrs>.
2. Touch-tone: 1-800-875-9694
3. Trouble number: 540-422-4246.

3. For more detailed information on operations and reservation procedures at a Slot Controlled Airport, please see 14 CFR Part 93, Subpart K – High Density Traffic Airports.

b. Special Traffic Management Programs (STMP).

1. Special procedures may be established when a location requires special traffic handling to accommodate above normal traffic demand (for example, the Indianapolis 500, Super Bowl, etc.) or

reduced airport capacity (for example, airport runway/taxiway closures for airport construction). The special procedures may remain in effect until the problem has been resolved or until local traffic management procedures can handle the situation and a need for special handling no longer exists.

2. There will be two methods available for obtaining slot reservations through the ATC-SCC: the web interface and the touch-tone interface. If these methods are used, a NOTAM will be issued relaying the website address and toll free telephone number. Be sure to check current NOTAMs to determine: what airports are included in the STMP, the dates and times reservations are required, the time limits for reservation requests, the point of contact for reservations, and any other instructions.

NOTE-

The telephone numbers/web address to obtain a STMP slot are:

1. Touch-tone interface: 1-800-875-9755.
2. Web interface: www.fly.faa.gov.
3. Trouble number: 540-422-4246.

c. Users may contact the ARO at (540) 422-4246 if they have a problem making a reservation or have a question concerning the slot controlled airport/STMP regulations or procedures.

d. Making Reservations.

1. **Internet Users.** Detailed information and User Instruction Guides for using the Web interface to the reservation systems are available on the websites for the slot controlled airports (e-CVRS), <http://www.fly.faa.gov/ecvrs>; and STMPs (e-STMP), <http://www.fly.faa.gov/estmp>.

4-1-22. Requests for Waivers and Authorizations from Title 14, Code of Federal Regulations (14 CFR)

a. Requests for a Certificate of Waiver or Authorization (FAA Form 7711-2), or requests for renewal of a waiver or authorization, may be accepted by any FAA facility and will be forwarded, if necessary, to the appropriate office having waiver authority.

b. The grant of a Certificate of Waiver or Authorization from 14 CFR constitutes relief from specific regulations, to the degree and for the period of time specified in the certificate, and does not waive any state law or local ordinance. Should the proposed operations conflict with any state law or local

ordinance, or require permission of local authorities or property owners, it is the applicant's responsibility to resolve the matter. The holder of a waiver is responsible for compliance with the terms of the waiver and its provisions.

c. A waiver may be canceled at any time by the Administrator, the person authorized to grant the waiver, or the representative designated to monitor a specific operation. In such case either written notice of cancellation, or written confirmation of a verbal cancellation will be provided to the holder.

4-1-23. Weather System Processor

The Weather System Processor (WSP) was developed for use in the National Airspace System to provide weather processor enhancements to selected Airport Surveillance Radar (ASR)-9 facilities. The WSP provides Air Traffic with warnings of hazardous wind shear and microbursts. The WSP also provides users with terminal area 6-level weather, storm cell locations and movement, as well as the location and predicted future position and intensity of wind shifts that may affect airport operations.

Section 2. Radio Communications Phraseology and Techniques

4-2-1. General

a. Radio communications are a critical link in the ATC system. The link can be a strong bond between pilot and controller or it can be broken with surprising speed and disastrous results. Discussion herein provides basic procedures for new pilots and also highlights safe operating concepts for all pilots.

b. The single, most important thought in pilot-controller communications is understanding. It is essential, therefore, that pilots acknowledge each radio communication with ATC by using the appropriate aircraft call sign. Brevity is important, and contacts should be kept as brief as possible, but controllers must know what you want to do before they can properly carry out their control duties. And you, the pilot, must know exactly what the controller wants you to do. Since concise phraseology may not always be adequate, use whatever words are necessary to get your message across. Pilots are to maintain vigilance in monitoring air traffic control radio communications frequencies for potential traffic conflicts with their aircraft especially when operating on an active runway and/or when conducting a final approach to landing.

c. All pilots will find the Pilot/Controller Glossary very helpful in learning what certain words or phrases mean. Good phraseology enhances safety and is the mark of a professional pilot. Jargon, chatter, and “CB” slang have no place in ATC communications. The Pilot/Controller Glossary is the same glossary used in FAA Order JO 7110.65, Air Traffic Control. We recommend that it be studied and reviewed from time to time to sharpen your communication skills.

4-2-2. Radio Technique

a. Listen before you transmit. Many times you can get the information you want through ATIS or by monitoring the frequency. Except for a few situations where some frequency overlap occurs, if you hear someone else talking, the keying of your transmitter will be futile and you will probably jam their receivers causing them to repeat their call. If you have

just changed frequencies, pause, listen, and make sure the frequency is clear.

b. Think before keying your transmitter. Know what you want to say and if it is lengthy; e.g., a flight plan or IFR position report, jot it down.

c. The microphone should be very close to your lips and after pressing the mike button, a slight pause may be necessary to be sure the first word is transmitted. Speak in a normal, conversational tone.

d. When you release the button, wait a few seconds before calling again. The controller or FSS specialist may be jotting down your number, looking for your flight plan, transmitting on a different frequency, or selecting the transmitter for your frequency.

e. Be alert to the sounds *or the lack of sounds* in your receiver. Check your volume, recheck your frequency, and *make sure that your microphone is not stuck* in the transmit position. Frequency blockage can, and has, occurred for extended periods of time due to unintentional transmitter operation. This type of interference is commonly referred to as a “stuck mike,” and controllers may refer to it in this manner when attempting to assign an alternate frequency. If the assigned frequency is completely blocked by this type of interference, use the procedures described for en route IFR radio frequency outage to establish or reestablish communications with ATC.

f. Be sure that you are within the performance range of your radio equipment and the ground station equipment. Remote radio sites do not always transmit and receive on all of a facility’s available frequencies, particularly with regard to VOR sites where you can hear but not reach a ground station’s receiver. Remember that higher altitudes increase the range of VHF “line of sight” communications.

4-2-3. Contact Procedures

a. Initial Contact.

1. The terms *initial contact* or *initial callup* means the first radio call you make to a given facility or the first call to a different controller or FSS specialist within a facility. Use the following format:

- (a) Name of the facility being called;
- (b) Your *full* aircraft identification as filed in the flight plan or as discussed in paragraph 4-2-4, Aircraft Call Signs;
- (c) When operating on an airport surface, state your position.
- (d) The type of message to follow or your request if it is short; and
- (e) The word “Over” if required.

EXAMPLE-

1. “New York Radio, Mooney Three One One Echo.”
2. “Columbia Ground, Cessna Three One Six Zero Foxtrot, south ramp, I-F-R Memphis.”
3. “Miami Center, Baron Five Six Three Hotel, request V-F-R traffic advisories.”

2. Many FSSs are equipped with Remote Communications Outlets (RCOs) and can transmit on the same frequency at more than one location. The frequencies available at specific locations are indicated on charts above FSS communications boxes. To enable the specialist to utilize the correct transmitter, advise the location and the frequency on which you expect a reply.

EXAMPLE-

St. Louis FSS can transmit on frequency 122.3 at either Farmington, Missouri, or Decatur, Illinois, if you are in the vicinity of Decatur, your callup should be “Saint Louis radio, Piper Six Niner Six Yankee, receiving Decatur One Two Two Point Three.”

3. If radio reception is reasonably assured, inclusion of your request, your position or altitude, and the phrase “(ATIS) Information Charlie received” in the initial contact helps decrease radio frequency congestion. Use discretion; do not overload the controller with information unneeded or superfluous. If you do not get a response from the ground station, recheck your radios or use another transmitter, but keep the next contact short.

EXAMPLE-

Atlanta Center, Duke Four One Romeo, request V-F-R traffic advisories, Twenty Northwest Rome, seven thousand five hundred, over.”

b. Initial Contact When Your Transmitting and Receiving Frequencies are Different.

1. If you are attempting to establish contact with a ground station and you are receiving on a different frequency than that transmitted, indicate the VOR name or the frequency on which you expect a reply.

Most FSSs and control facilities can transmit on several VOR stations in the area. Use the appropriate FSS call sign as indicated on charts.

EXAMPLE-

New York FSS transmits on the Kennedy, the Hampton, and the Calverton VORTACs. If you are in the Calverton area, your callup should be “New York radio, Cessna Three One Six Zero Foxtrot, receiving Calverton V-O-R, over.”

2. If the chart indicates FSS frequencies above the VORTAC or in the FSS communications boxes, transmit or receive on those frequencies nearest your location.

3. When unable to establish contact and you wish to call *any* ground station, use the phrase “ANY RADIO (tower) (station), GIVE CESSNA THREE ONE SIX ZERO FOXTROT A CALL ON (frequency) OR (V-O-R).” If an emergency exists or you need assistance, so state.

c. Subsequent Contacts and Responses to Callup from a Ground Facility.

Use the same format as used for the initial contact except you should state your message or request with the callup in one transmission. The ground station name and the word “Over” may be omitted if the message requires an obvious reply and there is no possibility for misunderstandings. *You should acknowledge all callups or clearances* unless the controller or FSS specialist advises otherwise. There are some occasions when controllers must issue time-critical instructions to other aircraft, and they may be in a position to observe your response, either visually or on radar. If the situation demands your response, take appropriate action or immediately advise the facility of any problem. Acknowledge with your aircraft identification, either at the beginning or at the end of your transmission, and one of the words “Wilco,” “Roger,” “Affirmative,” “Negative,” or other appropriate remarks; e.g., “PIPER TWO ONE FOUR LIMA, ROGER.” If you have been receiving services; e.g., VFR traffic advisories and you are leaving the area or changing frequencies, advise the ATC facility and terminate contact.

d. Acknowledgement of Frequency Changes.

1. When advised by ATC to change frequencies, acknowledge the instruction. If you select the new frequency without an acknowledgement, the controller’s workload is increased because there is no way of knowing whether you received the instruction or have had radio communications failure.

2. At times, a controller/specialist may be working a sector with multiple frequency assignments. In order to eliminate unnecessary verbiage and to free the controller/specialist for higher priority transmissions, the controller/specialist may request the pilot “(Identification), change to my frequency 123.4.” This phrase should alert the pilot that the controller/specialist is only changing frequencies, not controller/specialist, and that initial callup phraseology may be abbreviated.

EXAMPLE-

“United Two Twenty-Two on one two three point four” or “one two three point four, United Two Twenty-Two.”

e. Compliance with Frequency Changes.

When instructed by ATC to change frequencies, select the new frequency as soon as possible unless instructed to make the change at a specific time, fix, or altitude. A delay in making the change could result in an untimely receipt of important information. If you are instructed to make the frequency change at a specific time, fix, or altitude, monitor the frequency you are on until reaching the specified time, fix, or altitudes unless instructed otherwise by ATC.

REFERENCE-

AIM, Paragraph 5-3-1, ARTCC Communications

4-2-4. Aircraft Call Signs

a. Precautions in the Use of Call Signs.

1. Improper use of call signs can result in pilots executing a clearance intended for another aircraft. Call signs should *never be abbreviated on an initial contact or at any time when other aircraft call signs have similar numbers/sounds or identical letters/number*; e.g., Cessna 6132F, Cessna 1622F, Baron 123F, Cherokee 7732F, etc.

EXAMPLE-

Assume that a controller issues an approach clearance to an aircraft at the bottom of a holding stack and an aircraft with a similar call sign (at the top of the stack) acknowledges the clearance with the last two or three numbers of the aircraft’s call sign. If the aircraft at the bottom of the stack did not hear the clearance and intervene, flight safety would be affected, and there would be no reason for either the controller or pilot to suspect that anything is wrong. This kind of “human factors” error can strike swiftly and is extremely difficult to rectify.

2. Pilots, therefore, must be certain that aircraft identification is complete and clearly identified

before taking action on an ATC clearance. ATC specialists will not abbreviate call signs of air carrier or other civil aircraft having authorized call signs. ATC specialists may initiate abbreviated call signs of other aircraft by using the *prefix and the last three digits/letters* of the aircraft identification after communications are established. The pilot may use the abbreviated call sign in subsequent contacts with the ATC specialist. When aware of similar/identical call signs, ATC specialists will take action to minimize errors by emphasizing certain numbers/letters, by repeating the entire call sign, by repeating the prefix, or by asking pilots to use a different call sign temporarily. Pilots should use the phrase “VERIFY CLEARANCE FOR (your complete call sign)” if doubt exists concerning proper identity.

3. Civil aircraft pilots should state the aircraft type, model or manufacturer’s name, followed by the digits/letters of the registration number. When the aircraft manufacturer’s name or model is stated, the prefix “N” is dropped; e.g., Aztec Two Four Six Four Alpha.

EXAMPLE-

1. *Bonanza Six Five Five Golf.*

2. *Breezy Six One Three Romeo Experimental (omit “Experimental” after initial contact).*

4. Air Taxi or other commercial operators *not* having FAA authorized call signs should prefix their normal identification with the phonetic word “Tango.”

EXAMPLE-

Tango Aztec Two Four Six Four Alpha.

5. Air carriers and commuter air carriers having FAA authorized call signs should identify themselves by stating the complete call sign (using group form for the numbers) and the word “super” or “heavy” if appropriate.

EXAMPLE-

1. *United Twenty-Five Heavy.*

2. *Midwest Commuter Seven Eleven.*

6. Military aircraft use a variety of systems including serial numbers, word call signs, and combinations of letters/numbers. Examples include Army Copter 48931; Air Force 61782; REACH 31792; Pat 157; Air Evac 17652; Navy Golf Alfa Kilo 21; Marine 4 Charlie 36, etc.

b. Air Ambulance Flights.

Because of the priority afforded air ambulance flights in the ATC system, extreme discretion is necessary when using the term “MEDEVAC.” It is only intended for those missions of an urgent medical nature and to be utilized only for that portion of the flight requiring expeditious handling. When requested by the pilot, necessary notification to expedite ground handling of patients, etc., is provided by ATC; however, when possible, this information should be passed in advance through non-ATC communications systems.

1. Civilian air ambulance flights responding to medical emergencies (first call to an accident scene, carrying patients, organ donors, organs, or other urgently needed lifesaving medical material) will be expedited by ATC when necessary. When expeditious handling is necessary, include the word “MEDEVAC” in the flight plan per paragraphs 5-1-8 and 5-1-9. In radio communications, use the call sign “MEDEVAC,” followed by the aircraft registration letters/numbers.

EXAMPLE-

MEDEVAC Two Six Four Six.

2. Similar provisions have been made for the use of “AIR EVAC” and “HOSP” by air ambulance flights, except that these flights will receive priority handling only when specifically requested.

3. Air carrier and air taxi flights responding to medical emergencies will also be expedited by ATC when necessary. The nature of these medical emergency flights usually concerns the transportation of urgently needed lifesaving medical materials or vital organs. **IT IS IMPERATIVE THAT THE COMPANY/PILOT DETERMINE, BY THE NATURE/URGENCY OF THE SPECIFIC MEDICAL CARGO, IF PRIORITY ATC ASSISTANCE IS REQUIRED.** Pilots must include the word “MEDEVAC” in the flight plan per paragraphs 5-1-8 and 5-1-9, and use the call sign “MEDEVAC,” followed by the company name and flight number for all transmissions when expeditious handling is required. It is important for ATC to be aware of “MEDEVAC” status, and it is the pilot’s responsibility to ensure that this information is provided to ATC.

EXAMPLE-

MEDEVAC Delta Thirty-Seven.

c. Student Pilots Radio Identification.

1. The FAA desires to help student pilots in acquiring sufficient practical experience in the environment in which they will be required to operate. To receive additional assistance while operating in areas of concentrated air traffic, student pilots need only identify themselves as a student pilot during their initial call to an FAA radio facility.

EXAMPLE-

Dayton tower, Fleetwing One Two Three Four, student pilot.

2. This special identification will alert FAA ATC personnel and enable them to provide student pilots with such extra assistance and consideration as they may need. It is recommended that student pilots identify themselves as such, on initial contact with each clearance delivery prior to taxiing, ground control, tower, approach and departure control frequency, or FSS contact.

4-2-5. Description of Interchange or Leased Aircraft

a. Controllers issue traffic information based on familiarity with airline equipment and color/markings. When an air carrier dispatches a flight using another company’s equipment and the pilot does not advise the terminal ATC facility, the possible confusion in aircraft identification can compromise safety.

b. Pilots flying an “interchange” or “leased” aircraft not bearing the colors/markings of the company operating the aircraft should inform the terminal ATC facility on first contact the name of the operating company and trip number, followed by the company name as displayed on the aircraft, and aircraft type.

EXAMPLE-

Air Cal Three Eleven, United (interchange/lease), Boeing Seven Two Seven.

4-2-6. Ground Station Call Signs

Pilots, when calling a ground station, should begin with the name of the facility being called followed by the type of the facility being called as indicated in TBL 4-2-1.

**TBL 4-2-1
Calling a Ground Station**

Facility	Call Sign
Airport UNICOM	“Shannon UNICOM”
FAA Flight Service Station	“Chicago Radio”
Airport Traffic Control Tower	“Augusta Tower”
Clearance Delivery Position (IFR)	“Dallas Clearance Delivery”
Ground Control Position in Tower	“Miami Ground”
Radar or Nonradar Approach Control Position	“Oklahoma City Approach”
Radar Departure Control Position	“St. Louis Departure”
FAA Air Route Traffic Control Center	“Washington Center”

**TBL 4-2-2
Phonetic Alphabet/Morse Code**

Character	Morse Code	Telephony	Phonic (Pronunciation)
A	• —	Alfa	(AL-FAH)
B	— •••	Bravo	(BRAH-VOH)
C	— • — •	Charlie	(CHAR-LEE) or (SHAR-LEE)
D	— ••	Delta	(DELL-TAH)
E	•	Echo	(ECK-OH)
F	•• — •	Foxtrot	(FOKS-TROT)
G	— — •	Golf	(GOLF)
H	••••	Hotel	(HOH-TEL)
I	••	India	(IN-DEE-AH)
J	• — — —	Juliett	(JEW-LEE-ETT)
K	— • —	Kilo	(KEY-LOH)
L	• — ••	Lima	(LEE-MAH)
M	— —	Mike	(MIKE)
N	— •	November	(NO-VEM-BER)
O	— — —	Oscar	(OSS-CAH)
P	• — — •	Papa	(PAH-PAH)
Q	— — • —	Quebec	(KEH-BECK)
R	• — •	Romeo	(ROW-ME-OH)
S	•••	Sierra	(SEE-AIR-RAH)
T	—	Tango	(TANG-GO)
U	•• —	Uniform	(YOU-NEE-FORM) or (OO-NEE-FORM)
V	••• —	Victor	(VIK-TAH)
W	• — —	Whiskey	(WISS-KEY)
X	— •• —	Xray	(ECKS-RAY)
Y	— • — —	Yankee	(YANG-KEY)
Z	— — ••	Zulu	(ZOO-LOO)
1	• — — — —	One	(WUN)
2	•• — — —	Two	(TOO)
3	••• — —	Three	(TREE)
4	•••• —	Four	(FOW-ER)
5	•••••	Five	(FIFE)
6	— ••••	Six	(SIX)
7	— — •••	Seven	(SEV-EN)
8	— — — ••	Eight	(AIT)
9	— — — — •	Nine	(NIN-ER)
0	— — — — —	Zero	(ZEE-RO)

4-2-7. Phonetic Alphabet

The International Civil Aviation Organization (ICAO) phonetic alphabet is used by FAA personnel when communications conditions are such that the information cannot be readily received without their use. ATC facilities may also request pilots to use phonetic letter equivalents when aircraft with similar sounding identifications are receiving communications on the same frequency. Pilots should use the phonetic alphabet when identifying their aircraft during initial contact with air traffic control facilities. Additionally, use the phonetic equivalents for single letters and to spell out groups of letters or difficult words during adverse communications conditions. (See TBL 4-2-2.)

4-2-8. Figures

a. Figures indicating hundreds and thousands in round number, as for ceiling heights, and upper wind levels up to 9,900 must be spoken in accordance with the following.

EXAMPLE-

1. 500 *five hundred*
2. 4,500 *four thousand five hundred*

b. Numbers above 9,900 must be spoken by separating the digits preceding the word “thousand.”

EXAMPLE-

1. 10,000 *one zero thousand*
2. 13,500 *one three thousand five hundred*

c. Transmit airway or jet route numbers as follows.

EXAMPLE-

1. V12 *Victor Twelve*
2. J533 *J Five Thirty-Three*

d. All other numbers must be transmitted by pronouncing each digit.

EXAMPLE-

10 one zero

e. When a radio frequency contains a decimal point, the decimal point is spoken as “POINT.”

EXAMPLE-

122.1 one two two point one

NOTE-

ICAO procedures require the decimal point be spoken as “DECIMAL.” The FAA will honor such usage by military aircraft and all other aircraft required to use ICAO procedures.

4-2-9. Altitudes and Flight Levels

a. Up to but not including 18,000 feet MSL, state the separate digits of the thousands plus the hundreds if appropriate.

EXAMPLE-

1. 12,000 *one two thousand*
2. 12,500 *one two thousand five hundred*

b. At and above 18,000 feet MSL (FL 180), state the words “flight level” followed by the separate digits of the flight level.

EXAMPLE-

1. 190 *Flight Level One Niner Zero*
2. 275 *Flight Level Two Seven Five*

4-2-10. Directions

The three digits of bearing, course, heading, or wind direction should always be magnetic. The word “true” must be added when it applies.

EXAMPLE-

1. (*Magnetic course*) 005 *zero zero five*
2. (*True course*) 050 *zero five zero true*
3. (*Magnetic bearing*) 360 *three six zero*
4. (*Magnetic heading*) 100 *heading one zero zero*
5. (*Wind direction*) 220 *wind two two zero*

4-2-11. Speeds

The separate digits of the speed followed by the word “KNOTS.” Except, controllers may omit the word “KNOTS” when using speed adjustment procedures; e.g., “REDUCE/INCREASE SPEED TO TWO FIVE ZERO.”

EXAMPLE-

- (*Speed*) 250 *two five zero knots*
 (*Speed*) 190 *one niner zero knots*

The separate digits of the Mach Number preceded by “Mach.”

EXAMPLE-

- (*Mach number*) 1.5 *Mach one point five*
 (*Mach number*) 0.64 *Mach point six four*
 (*Mach number*) 0.7 *Mach point seven*

4-2-12. Time

a. FAA uses Coordinated Universal Time (UTC) for all operations. The word “local” or the time zone equivalent must be used to denote local when local time is given during radio and telephone communications. The term “Zulu” may be used to denote UTC.

EXAMPLE-

- 0920 UTC zero niner two zero,
 zero one two zero pacific or local,
 or one twenty AM*

b. To convert from Standard Time to Coordinated Universal Time:

TBL 4-2-3

Standard Time to Coordinated Universal Time

Eastern Standard Time	Add 5 hours
Central Standard Time	Add 6 hours
Mountain Standard Time	Add 7 hours
Pacific Standard Time	Add 8 hours
Alaska Standard Time	Add 9 hours
Hawaii Standard Time	Add 10 hours

NOTE-

For daylight time, subtract 1 hour.

c. A reference may be made to local daylight or standard time utilizing the 24-hour clock system. The hour is indicated by the first two figures and the minutes by the last two figures.

EXAMPLE-

0000 zero zero zero zero
0920 zero niner two zero

d. Time may be stated in minutes only (two figures) in radiotelephone communications when no misunderstanding is likely to occur.

e. Current time in use at a station is stated in the nearest quarter minute in order that pilots may use this information for time checks. Fractions of a quarter minute less than 8 seconds are stated as the preceding quarter minute; fractions of a quarter minute of 8 seconds or more are stated as the succeeding quarter minute.

EXAMPLE-

0929:05 time, zero niner two niner
0929:10 time, zero niner two niner and one-quarter

4-2-13. Communications with Tower when Aircraft Transmitter or Receiver or Both are Inoperative

a. Arriving Aircraft.

1. Receiver inoperative.

(a) If you have reason to believe your receiver is inoperative, remain outside or above the Class D surface area until the direction and flow of traffic has been determined; then, advise the tower of your type aircraft, position, altitude, intention to land, and request that you be controlled with light signals.

REFERENCE-

AIM, Paragraph 4-3-13, Traffic Control Light Signals

(b) When you are approximately 3 to 5 miles from the airport, advise the tower of your position and join the airport traffic pattern. From this point on, watch the tower for light signals. Thereafter, if a complete pattern is made, transmit your position downwind and/or turning base leg.

2. Transmitter inoperative. Remain outside or above the Class D surface area until the direction and flow of traffic has been determined; then, join the airport traffic pattern. Monitor the primary local control frequency as depicted on Sectional Charts for landing or traffic information, and look for a light signal which may be addressed to your aircraft. During hours of daylight, acknowledge tower transmissions or light signals by rocking your wings. At night, acknowledge by blinking the landing or navigation lights. To acknowledge tower transmissions during daylight hours, hovering helicopters will turn in the direction of the controlling facility and flash the landing light. While in flight, helicopters should show their acknowledgement of receiving a transmission by making shallow banks in opposite directions. At night, helicopters will acknowledge receipt of transmissions by flashing either the landing or the search light.

3. Transmitter and receiver inoperative. Remain outside or above the Class D surface area until the direction and flow of traffic has been determined; then, join the airport traffic pattern and maintain visual contact with the tower to receive light signals. Acknowledge light signals as noted above.

b. Departing Aircraft. If you experience radio failure prior to leaving the parking area, make every effort to have the equipment repaired. If you are unable to have the malfunction repaired, call the tower by telephone and request authorization to depart without two-way radio communications. If tower authorization is granted, you will be given departure information and requested to monitor the tower frequency or watch for light signals as appropriate. During daylight hours, acknowledge tower transmissions or light signals by moving the ailerons or rudder. At night, acknowledge by blinking the landing or navigation lights. If radio malfunction

occurs after departing the parking area, watch the tower for light signals or monitor tower frequency.

REFERENCE-

14 CFR Section 91.125 and 14 CFR Section 91.129.

4-2-14. Communications for VFR Flights

a. FSSs and Supplemental Weather Service Locations (SWSL) are allocated frequencies for different functions; for example, in Alaska, certain FSSs provide Local Airport Advisory on 123.6 MHz or other frequencies which can be found in the Chart Supplement U.S. If you are in doubt as to what frequency to use, 122.2 MHz is assigned to the majority of FSSs as a common en route simplex frequency.

NOTE-

In order to expedite communications, state the frequency being used and the aircraft location during initial callup.

EXAMPLE-

Dayton radio, November One Two Three Four Five on one two two point two, over Springfield V-O-R, over.

b. Certain VOR voice channels are being utilized for recorded broadcasts; i.e., ATIS, HIWAS, etc. These services and appropriate frequencies are listed in the Chart Supplement U.S. On VFR flights, pilots are urged to monitor these frequencies. When in contact with a control facility, notify the controller if you plan to leave the frequency to monitor these broadcasts.

Section 3. Airport Operations

4-3-1. General

Increased traffic congestion, aircraft in climb and descent attitudes, and pilot preoccupation with cockpit duties are some factors that increase the hazardous accident potential near the airport. The situation is further compounded when the weather is marginal, that is, just meeting VFR requirements. Pilots must be particularly alert when operating in the vicinity of an airport. This section defines some rules, practices, and procedures that pilots should be familiar with and adhere to for safe airport operations.

4-3-2. Airports with an Operating Control Tower

a. When operating at an airport where traffic control is being exercised by a control tower, pilots are required to maintain two-way radio contact with the tower while operating within the Class B, Class C, and Class D surface area unless the tower authorizes otherwise. Initial callup should be made about 15 miles from the airport. Unless there is a good reason to leave the tower frequency before exiting the Class B, Class C, and Class D surface areas, it is a good operating practice to remain on the tower frequency for the purpose of receiving traffic information. In the interest of reducing tower frequency congestion, pilots are reminded that it is not necessary to request permission to leave the tower frequency once outside of Class B, Class C, and Class D surface areas. Not all airports with an operating control tower will have Class D airspace. These airports do not have weather reporting which is a requirement for surface based controlled airspace, previously known as a control zone. The controlled airspace over these airports will normally begin at 700 feet or 1,200 feet above ground level and can be determined from the visual aeronautical charts. Pilots are expected to use good operating practices and communicate with the control tower as described in this section.

b. When necessary, the tower controller will issue clearances or other information for aircraft to generally follow the desired flight path (traffic patterns) when flying in Class B, Class C, and Class D surface areas and the proper taxi routes when operating on the ground. If not otherwise authorized

or directed by the tower, pilots of fixed-wing aircraft approaching to land must circle the airport to the left. Pilots approaching to land in a helicopter must avoid the flow of fixed-wing traffic. However, in all instances, an appropriate clearance must be received from the tower before landing.

FIG 4-3-1
Components of a Traffic Pattern

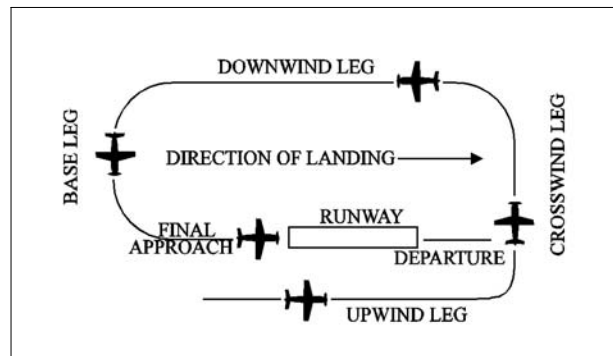

NOTE-

This diagram is intended only to illustrate terminology used in identifying various components of a traffic pattern. It should not be used as a reference or guide on how to enter a traffic pattern.

c. The following terminology for the various components of a traffic pattern has been adopted as standard for use by control towers and pilots (See FIG 4-3-1):

1. **Upwind leg.** A flight path parallel to the landing runway in the direction of landing.
2. **Crosswind leg.** A flight path at right angles to the landing runway off its takeoff end.
3. **Downwind leg.** A flight path parallel to the landing runway in the opposite direction of landing.
4. **Base leg.** A flight path at right angles to the landing runway off its approach end and extending from the downwind leg to the intersection of the extended runway centerline.
5. **Final approach.** A flight path in the direction of landing along the extended runway centerline from the base leg to the runway.
6. **Departure.** The flight path which begins after takeoff and continues straight ahead along the extended runway centerline. The departure climb continues until reaching a point at least $\frac{1}{2}$ mile

beyond the departure end of the runway and within 300 feet of the traffic pattern altitude.

d. Many towers are equipped with a tower radar display. The radar uses are intended to enhance the effectiveness and efficiency of the local control, or tower, position. They are not intended to provide radar services or benefits to pilots except as they may accrue through a more efficient tower operation. The four basic uses are:

1. To determine an aircraft's exact location.

This is accomplished by radar identifying the VFR aircraft through any of the techniques available to a radar position, such as having the aircraft *squawk ident*. Once identified, the aircraft's position and spatial relationship to other aircraft can be quickly determined, and standard instructions regarding VFR operation in Class B, Class C, and Class D surface areas will be issued. Once initial radar identification of a VFR aircraft has been established and the appropriate instructions have been issued, radar monitoring may be discontinued; the reason being that the local controller's primary means of surveillance in VFR conditions is visually scanning the airport and local area.

2. To provide radar traffic advisories. Radar traffic advisories may be provided to the extent that the local controller is able to monitor the radar display. Local control has primary control responsibilities to the aircraft operating on the runways, which will normally supersede radar monitoring duties.

3. To provide a direction or suggested heading. The local controller may provide pilots flying VFR with generalized instructions which will facilitate operations; e.g., "PROCEED SOUTH-WESTBOUND, ENTER A RIGHT DOWNWIND RUNWAY THREE ZERO," or provide a suggested heading to establish radar identification or as an advisory aid to navigation; e.g., "SUGGESTED HEADING TWO TWO ZERO, FOR RADAR IDENTIFICATION." In both cases, the instructions are advisory aids to the pilot flying VFR and are not radar vectors.

NOTE-

Pilots have complete discretion regarding acceptance of the suggested headings or directions and have sole responsibility for seeing and avoiding other aircraft.

4. To provide information and instructions to aircraft operating within Class B, Class C, and

Class D surface areas. In an example of this situation, the local controller would use the radar to advise a pilot on an extended downwind when to turn base leg.

NOTE-

The above tower radar applications are intended to augment the standard functions of the local control position. There is no controller requirement to maintain constant radar identification. In fact, such a requirement could compromise the local controller's ability to visually scan the airport and local area to meet FAA responsibilities to the aircraft operating on the runways and within the Class B, Class C, and Class D surface areas. Normally, pilots will not be advised of being in radar contact since that continued status cannot be guaranteed and since the purpose of the radar identification is not to establish a link for the provision of radar services.

e. A few of the radar equipped towers are authorized to use the radar to ensure separation between aircraft in specific situations, while still others may function as limited radar approach controls. The various radar uses are strictly a function of FAA operational need. The facilities may be indistinguishable to pilots since they are all referred to as tower and no publication lists the degree of radar use. Therefore, when in communication with a tower controller who may have radar available, do not assume that constant radar monitoring and complete ATC radar services are being provided.

4-3-3. Traffic Patterns

a. It is recommended that aircraft enter the airport traffic pattern at one of the following altitudes listed below. These altitudes should be maintained unless another traffic pattern altitude is published in the Chart Supplement U.S. or unless otherwise required by the applicable distance from cloud criteria (14 CFR Section 91.155). (See FIG 4-3-2 and FIG 4-3-3):

1. Propeller-driven aircraft enter the traffic pattern at 1,000 feet above ground level (AGL).

2. Large and turbine-powered aircraft enter the traffic pattern at an altitude of not less than 1,500 feet AGL or 500 feet above the established pattern altitude.

3. Helicopters operating in the traffic pattern may fly a pattern similar to the fixed-wing aircraft pattern, but at a lower altitude (500 AGL) and closer to the runway. This pattern may be on the opposite side of the runway from fixed-wing traffic when

airspeed requires or for practice power-off landings (autorotation) and if local policy permits. Landings not to the runway must avoid the flow of fixed wing traffic.

b. A pilot may vary the size of the traffic pattern depending on the aircraft's performance characteristics. Pilots of en route aircraft should be constantly alert for aircraft in traffic patterns and avoid these areas whenever possible.

c. Unless otherwise indicated, all turns in the traffic pattern must be made to the left, except for helicopters, as applicable.

d. On Sectional, Aeronautical, and VFR Terminal Area Charts, right traffic patterns are indicated at public-use and joint-use airports with the abbreviation "RP" (for Right Pattern), followed by the appropriate runway number(s) at the bottom of the airport data block.

EXAMPLE-

RP 9, 18, 22R

NOTE-

1. *Pilots are encouraged to use the standard traffic pattern. However, those pilots who choose to execute a straight-in approach, maneuvering for and execution of the approach should not disrupt the flow of arriving and departing traffic. Likewise, pilots operating in the traffic pattern should be alert at all times for aircraft executing straight-in approaches.*

REFERENCE-

AC 90-66B, Non-Towered Airport Flight Operations

2. **RP indicates special conditions exist and refers pilots to the Chart Supplement U.S.*

3. *Right traffic patterns are not shown at airports with full-time control towers.*

e. Wind conditions affect all airplanes in varying degrees. Figure 4-3-4 is an example of a chart used to determine the headwind, crosswind, and tailwind components based on wind direction and velocity relative to the runway. Pilots should refer to similar information provided by the aircraft manufacturer when determining these wind components.

FIG 4-3-2
Traffic Pattern Operations
Single Runway

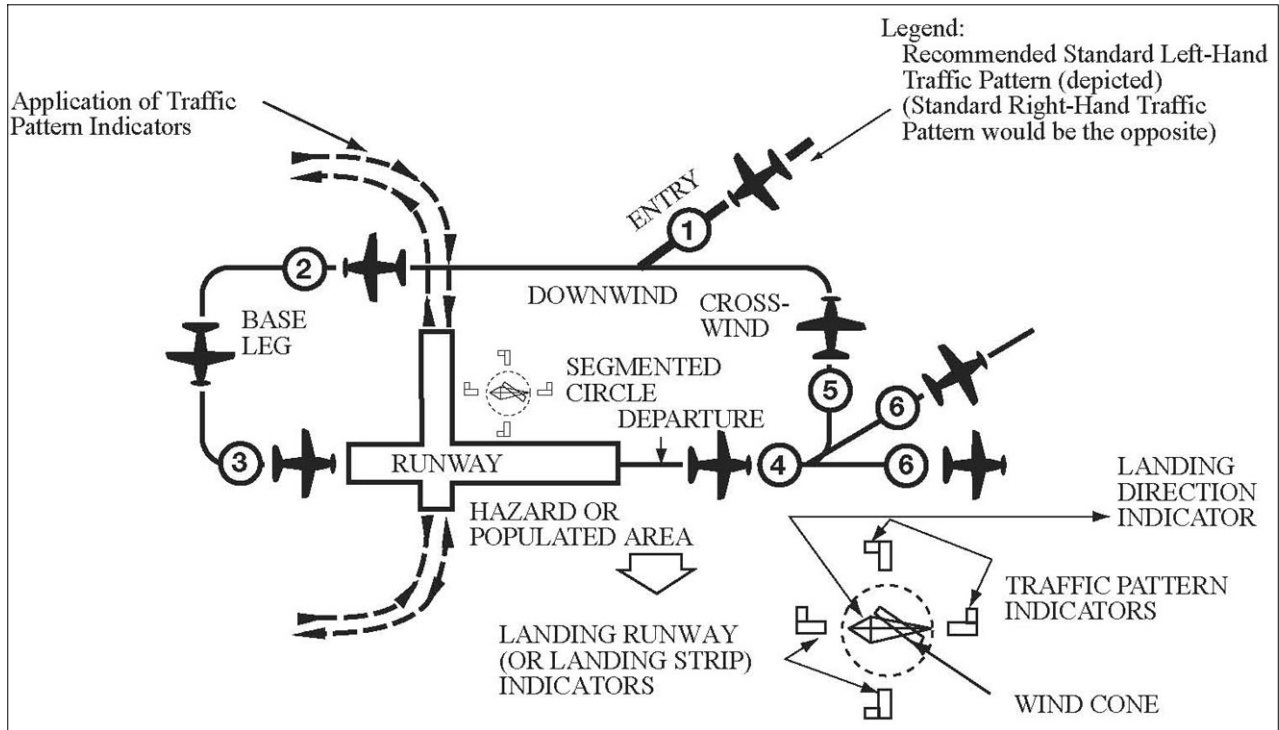

EXAMPLE-

Key to traffic pattern operations

1. Enter pattern in level flight, abeam the midpoint of the runway, at pattern altitude.
2. Maintain pattern altitude until abeam approach end of the landing runway on downwind leg.
3. Complete turn to final at least $\frac{1}{4}$ mile from the runway.
4. Continue straight ahead until beyond departure end of

runway.

5. If remaining in the traffic pattern, commence turn to crosswind leg beyond the departure end of the runway within 300 feet of pattern altitude.
6. If departing the traffic pattern, continue straight out, or exit with a 45 degree turn (to the left when in a left-hand traffic pattern; to the right when in a right-hand traffic pattern) beyond the departure end of the runway, after reaching pattern altitude.

FIG 4-3-3
Traffic Pattern Operations
Parallel Runways

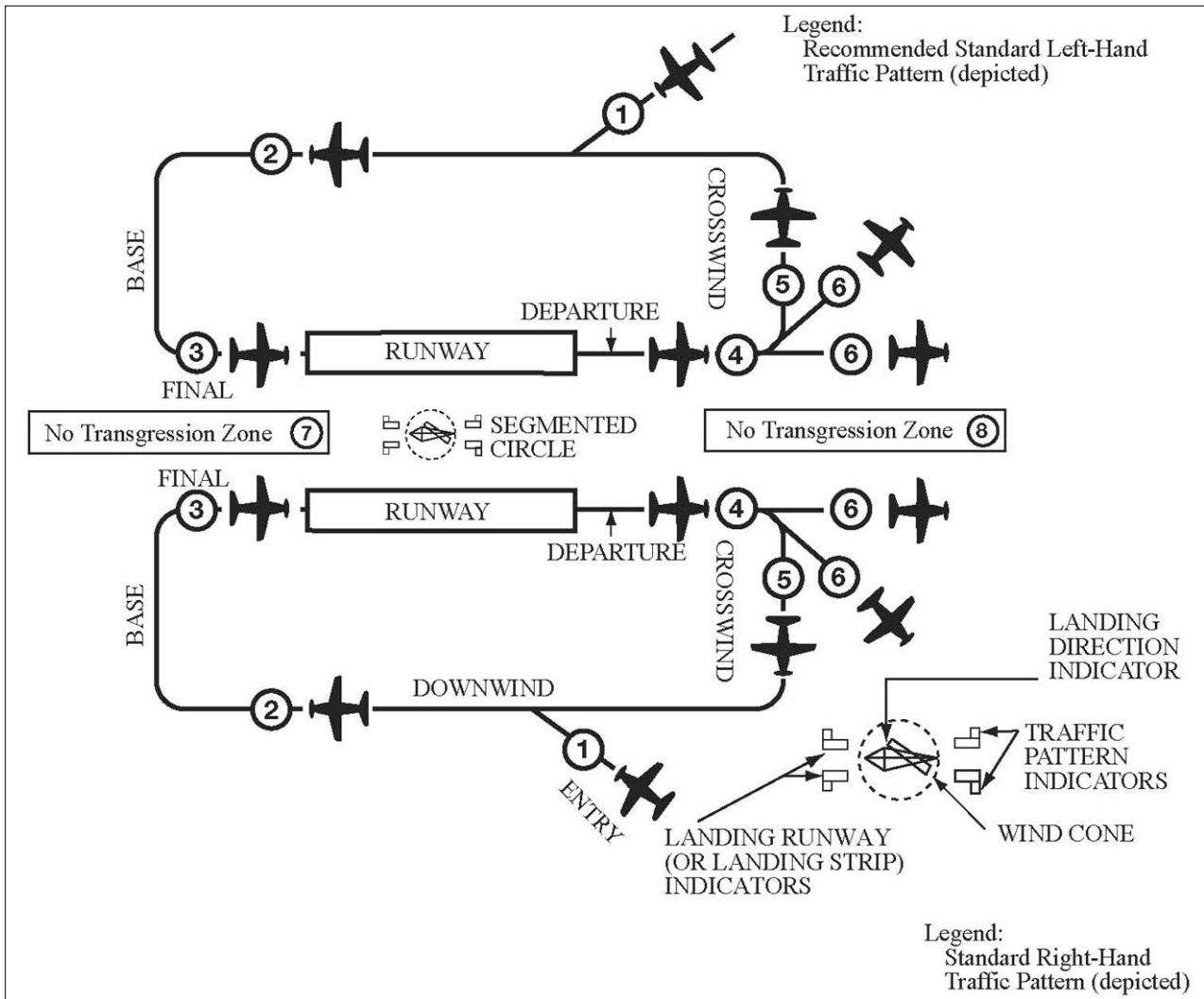

EXAMPLE-
Key to traffic pattern operations

1. Enter pattern in level flight, abeam the midpoint of the runway, at pattern altitude.
2. Maintain pattern altitude until abeam approach end of the landing runway on downwind leg.
3. Complete turn to final at least 1/4 mile from the runway.
4. Continue straight ahead until beyond departure end of runway.
5. If remaining in the traffic pattern, commence turn to

crosswind leg beyond the departure end of the runway within 300 feet of pattern altitude.

6. If departing the traffic pattern, continue straight out, or exit with a 45 degree turn (to the left when in a left-hand traffic pattern; to the right when in a right-hand traffic pattern) beyond the departure end of the runway, after reaching pattern altitude.
7. Do not overshoot final or continue on a track which will penetrate the final approach of the parallel runway.
8. Do not continue on a track which will penetrate the departure path of the parallel runway.

FIG 4-3-4
Headwind/Tailwind/Crosswind Component Calculator

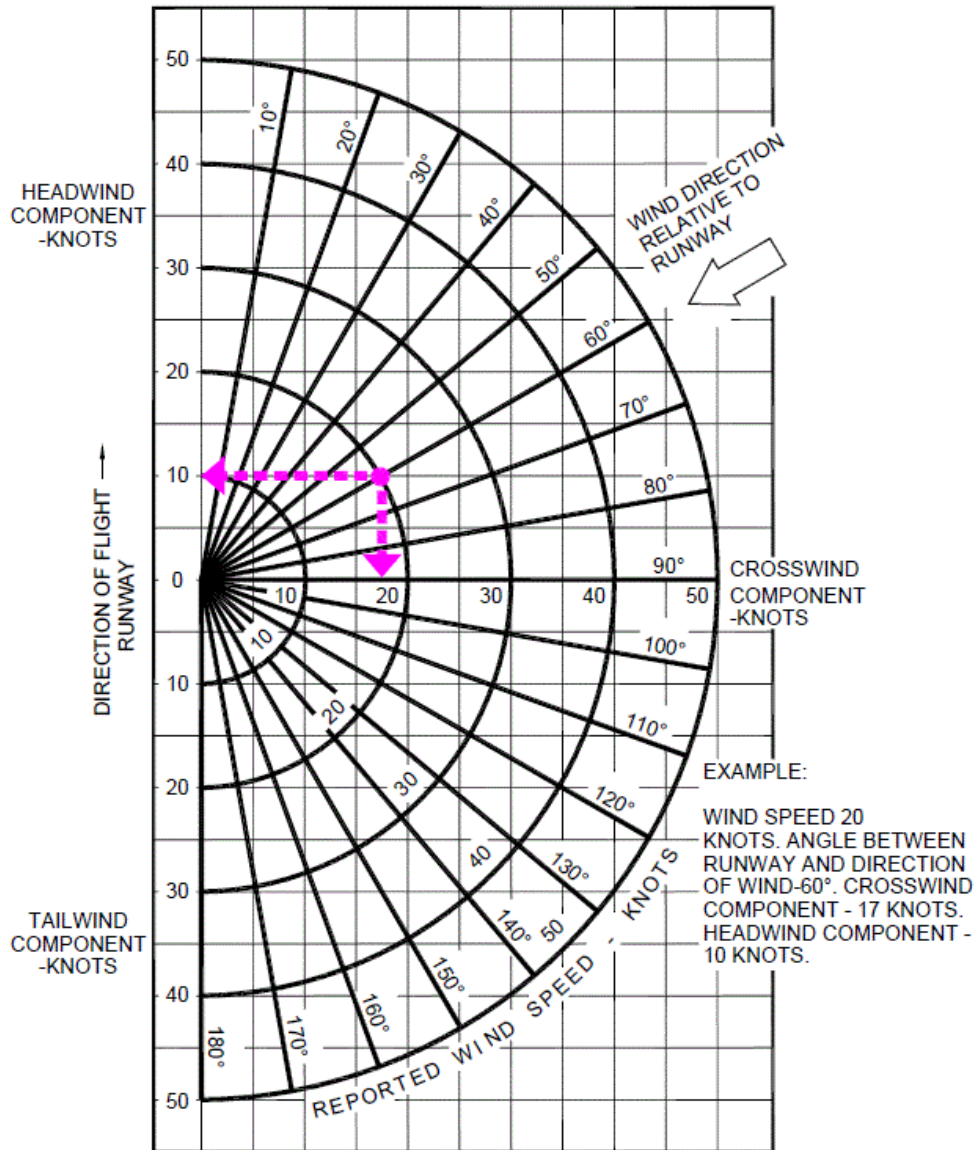

4-3-4. Visual Indicators at Airports Without an Operating Control Tower

a. At those airports *without an operating control tower*, a segmented circle visual indicator system, if installed, is designed to provide traffic pattern information.

REFERENCE-
AIM, Paragraph 4-1-9, *Traffic Advisory Practices at Airports Without Operating Control Towers*

b. The segmented circle system consists of the following components:

1. The segmented circle. Located in a position affording maximum visibility to pilots in the air and on the ground and providing a centralized location for other elements of the system.

2. The wind direction indicator. A wind cone, wind sock, or wind tee installed near the operational runway to indicate wind direction. The large end of the wind cone/wind sock points into the wind as does the large end (cross bar) of the wind tee. In lieu of a tetrahedron and where a wind sock or wind cone is collocated with a wind tee, the wind tee may be manually aligned with the runway in use to indicate landing direction. These signaling devices may be located in the center of the segmented circle and may be lighted for night use. Pilots are cautioned against using a tetrahedron to indicate wind direction.

3. The landing direction indicator. A tetrahedron is installed when conditions at the airport warrant its use. It may be used to indicate the direction of landings and takeoffs. A tetrahedron may be located at the center of a segmented circle and may be lighted for night operations. The small end of the tetrahedron points in the direction of landing. Pilots are cautioned against using a tetrahedron for any purpose other than as an indicator of landing direction. Further, pilots should use extreme caution when making runway selection by use of a tetrahedron in very light or calm wind conditions as the tetrahedron may not be aligned with the designated calm-wind runway. At airports with control towers, the tetrahedron should only be referenced when the control tower is not in operation. Tower instructions supersede tetrahedron indications.

4. Landing strip indicators. Installed in pairs as shown in the segmented circle diagram and used to show the alignment of landing strips.

5. Traffic pattern indicators. Arranged in pairs in conjunction with landing strip indicators and used to indicate the direction of turns when there is a variation from the normal left traffic pattern. (If there is no segmented circle installed at the airport, traffic pattern indicators may be installed on or near the end of the runway.)

c. Preparatory to landing at an airport without a control tower, or when the control tower is not in operation, pilots should concern themselves with the indicator for the approach end of the runway to be used. When approaching for landing, all turns must be made to the left unless a traffic pattern indicator indicates that turns should be made to the right. If the pilot will mentally enlarge the indicator for the runway to be used, the base and final approach legs of the traffic pattern to be flown immediately become apparent. Similar treatment of the indicator at the departure end of the runway will clearly indicate the direction of turn after takeoff.

d. When two or more aircraft are approaching an airport for the purpose of landing, the pilot of the aircraft at the lower altitude has the right-of-way over the pilot of the aircraft at the higher altitude. However, the pilot operating at the lower altitude should not take advantage of another aircraft, which is on final approach to land, by cutting in front of, or overtaking that aircraft.

4-3-5. Unexpected Maneuvers in the Airport Traffic Pattern

There have been several incidents in the vicinity of controlled airports that were caused primarily by aircraft executing unexpected maneuvers. ATC service is based upon observed or known traffic and airport conditions. Controllers establish the sequence of arriving and departing aircraft by requiring them to adjust flight as necessary to achieve proper spacing. These adjustments can only be based on observed traffic, accurate pilot reports, and anticipated aircraft maneuvers. Pilots are expected to cooperate so as to preclude disrupting traffic flows or creating conflicting patterns. The pilot-in-command of an aircraft is directly responsible for and is the final authority as to the operation of the aircraft. On occasion it may be necessary for pilots to maneuver their aircraft to maintain spacing with the traffic they have been sequenced to follow. The controller can anticipate minor maneuvering such as shallow "S" turns. The controller cannot, however, anticipate a

major maneuver such as a 360 degree turn. If a pilot makes a 360 degree turn after obtaining a landing sequence, the result is usually a gap in the landing interval and, more importantly, it causes a chain reaction which may result in a conflict with following traffic and an interruption of the sequence established by the tower or approach controller. Should a pilot decide to make maneuvering turns to maintain spacing behind a preceding aircraft, the pilot should always advise the controller if at all possible. Except when requested by the controller or in emergency situations, a 360 degree turn should never be executed in the traffic pattern or when receiving radar service without first advising the controller.

4-3-6. Use of Runways/Declared Distances

a. Runways are identified by numbers which indicate the nearest 10-degree increment of the azimuth of the runway centerline. For example, where the magnetic azimuth is 183 degrees, the runway designation would be 18; for a magnetic azimuth of 87 degrees, the runway designation would be 9. For a magnetic azimuth ending in the number 5, such as 185, the runway designation could be either 18 or 19. Wind direction issued by the tower is also magnetic and wind velocity is in knots.

b. Airport proprietors are responsible for taking the lead in local aviation noise control. Accordingly, they may propose specific noise abatement plans to the FAA. If approved, these plans are applied in the form of Formal or Informal Runway Use Programs for noise abatement purposes.

REFERENCE-
Pilot/Controller Glossary Term- Runway Use Program

1. At airports where no runway use program is established, ATC clearances may specify:

(a) The runway most nearly aligned with the wind when it is 5 knots or more;

(b) The “calm wind” runway when wind is less than 5 knots; or

(c) Another runway if operationally advantageous.

NOTE-
It is not necessary for a controller to specifically inquire if the pilot will use a specific runway or to offer a choice of runways. If a pilot prefers to use a different runway from that specified, or the one most nearly aligned with the wind, the pilot is expected to inform ATC accordingly.

2. At airports where a runway use program is established, ATC will assign runways deemed to have the least noise impact. If in the interest of safety a runway different from that specified is preferred, the pilot is expected to advise ATC accordingly. ATC will honor such requests and advise pilots when the requested runway is noise sensitive. When use of a runway other than the one assigned is requested, pilot cooperation is encouraged to preclude disruption of traffic flows or the creation of conflicting patterns.

c. Declared Distances.

1. Declared distances for a runway represent the maximum distances available and suitable for meeting takeoff and landing distance performance requirements. These distances are determined in accordance with FAA runway design standards by adding to the physical length of paved runway any clearway or stopway and subtracting from that sum any lengths necessary to obtain the standard runway safety areas, runway object free areas, or runway protection zones. As a result of these additions and subtractions, the declared distances for a runway may be more or less than the physical length of the runway as depicted on aeronautical charts and related publications, or available in electronic navigation databases provided by either the U.S. Government or commercial companies.

2. All 14 CFR Part 139 airports report declared distances for each runway. Other airports may also report declared distances for a runway if necessary to meet runway design standards or to indicate the presence of a clearway or stopway. Where reported, declared distances for each runway end are published in the Chart Supplement U.S. For runways without published declared distances, the declared distances may be assumed to be equal to the physical length of the runway unless there is a displaced landing threshold, in which case the Landing Distance Available (LDA) is shortened by the amount of the threshold displacement.

NOTE-

*A symbol **D** is shown on U.S. Government charts to indicate that runway declared distance information is available (See appropriate Chart Supplement U.S., Chart Supplement Alaska or Pacific).*

(a) The FAA uses the following definitions for runway declared distances (See FIG 4-3-5):

REFERENCE-
Pilot/Controller Glossary Terms: “Accelerate-Stop Distance Available,” “Landing Distance Available,” “Takeoff Distance Available,” “Takeoff Run Available,” “Stopway,” and “Clearway.”

(1) Takeoff Run Available (TORA) – The runway length declared available and suitable for the ground run of an airplane taking off.

The TORA is typically the physical length of the runway, but it may be shorter than the runway length if necessary to satisfy runway design standards. For example, the TORA may be shorter than the runway length if a portion of the runway must be used to satisfy runway protection zone requirements.

(2) Takeoff Distance Available (TODA) – The takeoff run available plus the length of any remaining runway or clearway beyond the far end of the takeoff run available.

The TODA is the distance declared available for satisfying takeoff distance requirements for airplanes where the certification and operating rules and available performance data allow for the consideration of a clearway in takeoff performance computations.

NOTE–

The length of any available clearway will be included in the TODA published in the entry for that runway end within the Chart Supplement U.S.

(3) Accelerate–Stop Distance Available (ASDA) – The runway plus stopway length declared available and suitable for the acceleration and deceleration of an airplane aborting a takeoff.

The ASDA may be longer than the physical length of the runway when a stopway has been designated available by the airport operator, or it may be shorter than the physical length of the runway if necessary to use a portion of the runway to satisfy runway design standards; for example, where the airport operator uses a portion of the runway to achieve the runway safety area requirement. ASDA is the distance used to satisfy the airplane accelerate–stop distance performance requirements where the certification and operating rules require accelerate–stop distance computations.

NOTE–

The length of any available stopway will be included in the ASDA published in the entry for that runway end within the Chart Supplement U.S.

(4) Landing Distance Available (LDA) – The runway length declared available and suitable for a landing airplane.

The LDA may be less than the physical length of the runway or the length of the runway remaining beyond a displaced threshold if necessary to satisfy runway design standards; for example, where the airport operator uses a portion of the runway to achieve the runway safety area requirement.

Although some runway elements (such as stopway length and clearway length) may be available information, pilots must use the declared distances determined by the airport operator and not attempt to independently calculate declared distances by adding those elements to the reported physical length of the runway.

(b) The airplane operating rules and/or the airplane operating limitations establish minimum distance requirements for takeoff and landing and are based on performance data supplied in the Airplane Flight Manual or Pilot’s Operating Handbook. The minimum distances required for takeoff and landing obtained either in planning prior to takeoff or in performance assessments conducted at the time of landing must fall within the applicable declared distances before the pilot can accept that runway for takeoff or landing.

(c) Runway design standards may impose restrictions on the amount of runway available for use in takeoff and landing that are not apparent from the reported physical length of the runway or from runway markings and lighting. The runway elements of Runway Safety Area (RSA), Runway Object Free Area (ROFA), and Runway Protection Zone (RPZ) may reduce a runway’s declared distances to less than the physical length of the runway at geographically constrained airports (See FIG 4–3–6). When considering the amount of runway available for use in takeoff or landing performance calculations, the declared distances published for a runway must always be used in lieu of the runway’s physical length.

REFERENCE–

AC 150/5300–13, Airport Design

(d) While some runway elements associated with declared distances may be identifiable through runway markings or lighting (for example, a displaced threshold or a stopway), the individual declared distance limits are not marked or otherwise identified on the runway. An aircraft is not prohibited from operating beyond a declared distance limit during the takeoff, landing, or taxi operation

provided the runway surface is appropriately marked as usable runway (See FIG 4-3-6). The following examples clarify the intent of this paragraph.

REFERENCE-

AIM, Paragraph 2-3-3, Runway Markings
AC 150/5340-1, Standards for Airport Markings

EXAMPLE-

1. *The declared LDA for runway 9 must be used when showing compliance with the landing distance requirements of the applicable airplane operating rules and/or airplane operating limitations or when making a before landing performance assessment. The LDA is less than the physical runway length, not only because of the displaced*

threshold, but also because of the subtractions necessary to meet the RSA beyond the far end of the runway. However, during the actual landing operation, it is permissible for the airplane to roll beyond the unmarked end of the LDA.

2. *The declared ASDA for runway 9 must be used when showing compliance with the accelerate-stop distance requirements of the applicable airplane operating rules and/or airplane operating limitations. The ASDA is less than the physical length of the runway due to subtractions necessary to achieve the full RSA requirement. However, in the event of an aborted takeoff, it is permissible for the airplane to roll beyond the unmarked end of the ASDA as it is brought to a full-stop on the remaining usable runway.*

FIG 4-3-5

Declared Distances with Full-Standard Runway Safety Areas, Runway Object Free Areas, and Runway Protection Zones

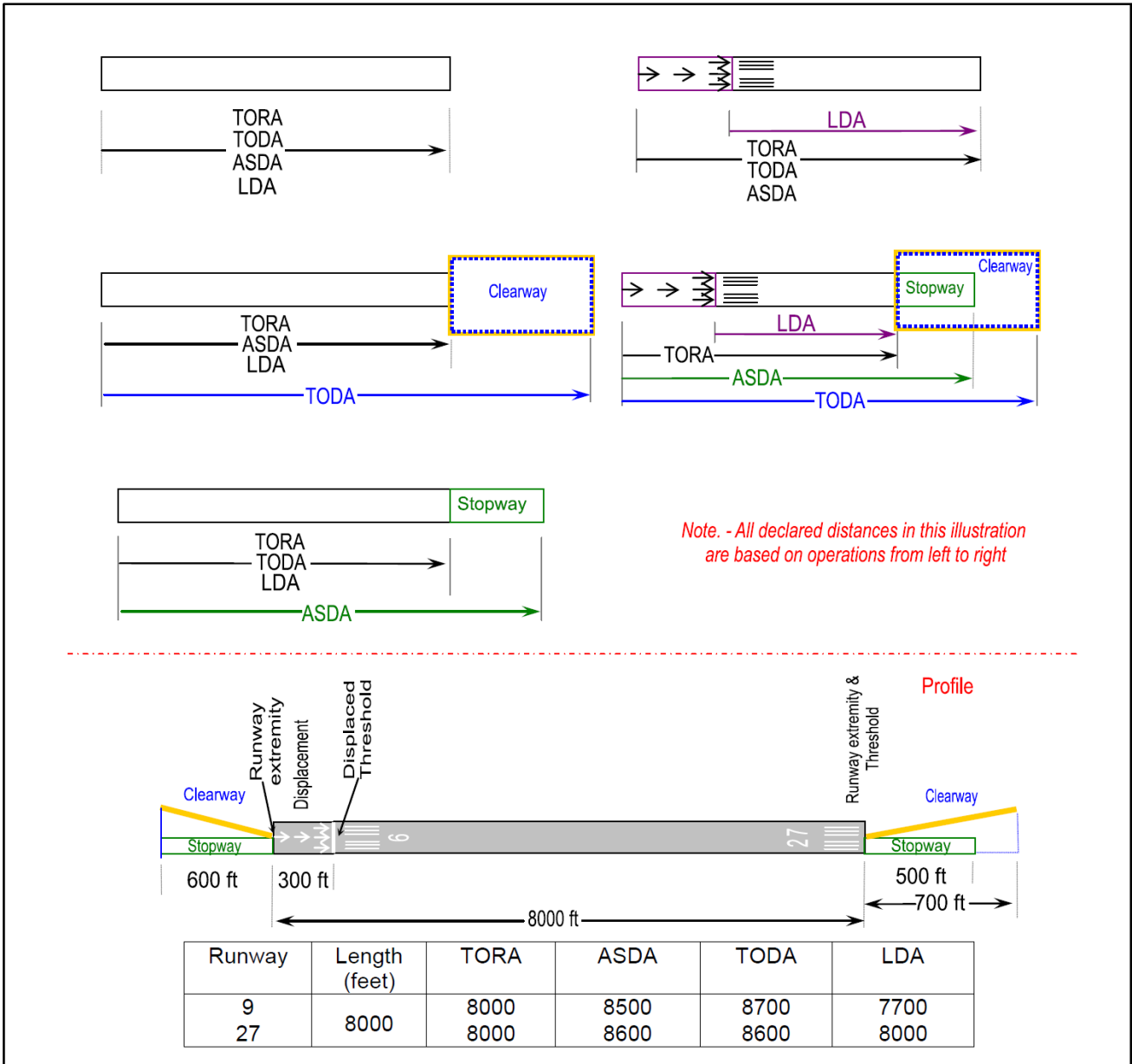
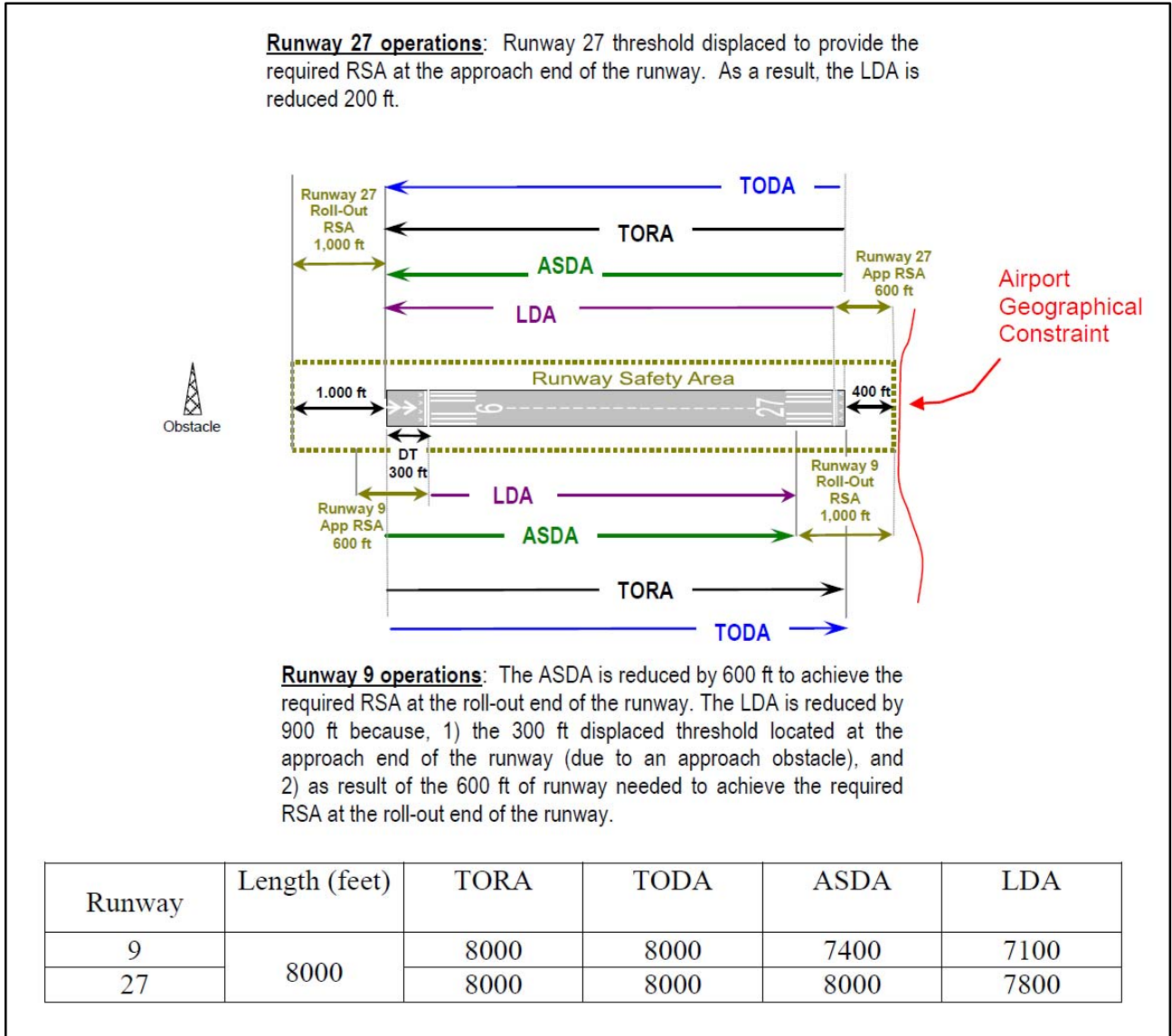

FIG 4-3-6

Effects of a Geographical Constraint on a Runway's Declared Distances



NOTE-

A runway's RSA begins a set distance prior to the threshold and will extend a set distance beyond the end of the runway depending on the runway's design criteria. If these required lengths cannot be achieved, the ASDA and/or LDA will be reduced as necessary to obtain the required lengths to the extent practicable.

4-3-7. Low Level Wind Shear/Microburst Detection Systems

Low Level Wind Shear Alert System (LLWAS), Terminal Doppler Weather Radar (TDWR), Weather System Processor (WSP), and Integrated Terminal Weather System (ITWS) display information on hazardous wind shear and microburst activity in the vicinity of an airport to air traffic controllers who relay this information to pilots.

a. LLWAS provides wind shear alert and gust front information but does not provide microburst alerts. The LLWAS is designed to detect low level wind shear conditions around the periphery of an airport. It does not detect wind shear beyond that limitation. Controllers will provide this information to pilots by giving the pilot the airport wind followed by the boundary wind.

EXAMPLE-

Wind shear alert, airport wind 230 at 8, south boundary wind 170 at 20.

b. LLWAS “network expansion,” (LLWAS NE) and LLWAS Relocation/Sustainment (LLWAS-RS) are systems integrated with TDWR. These systems provide the capability of detecting microburst alerts and wind shear alerts. Controllers will issue the appropriate wind shear alerts or microburst alerts. In some of these systems controllers also have the ability to issue wind information oriented to the threshold or departure end of the runway.

EXAMPLE-

Runway 17 arrival microburst alert, 40 knot loss 3 mile final.

REFERENCE-

AIM, Paragraph 7-1-26, Microbursts

c. More advanced systems are in the field or being developed such as ITWS. ITWS provides alerts for microbursts, wind shear, and significant thunderstorm activity. ITWS displays wind information oriented to the threshold or departure end of the runway.

d. The WSP provides weather processor enhancements to selected Airport Surveillance Radar (ASR)-9 facilities. The WSP provides Air Traffic with detection and alerting of hazardous weather such as wind shear, microbursts, and significant thunderstorm activity. The WSP displays terminal area 6 level weather, storm cell locations and movement, as well as the location and predicted future position

and intensity of wind shifts that may affect airport operations. Controllers will receive and issue alerts based on Areas Noted for Attention (ARENA). An ARENA extends on the runway center line from a 3 mile final to the runway to a 2 mile departure.

e. An airport equipped with the LLWAS, ITWS, or WSP is so indicated in the Chart Supplement U.S. under Weather Data Sources for that particular airport.

4-3-8. Braking Action Reports and Advisories

a. When available, ATC furnishes pilots the quality of braking action received from pilots. The quality of braking action is described by the terms “good,” “good to medium,” “medium,” “medium to poor,” “poor,” and “nil.” When pilots report the quality of braking action by using the terms noted above, they should use descriptive terms that are easily understood, such as, “braking action poor the first/last half of the runway,” together with the particular type of aircraft.

b. FICON NOTAMs will provide contaminant measurements for paved runways; however, a FICON NOTAM for braking action will only be used for non-paved runway surfaces, taxiways, and aprons. These NOTAMs are classified according to the most critical term (“good to medium,” “medium,” “medium to poor,” and “poor”).

1. FICON NOTAM reporting of a braking condition for paved runway surfaces is not permissible by Federally Obligated Airports or those airports certificated under 14 CFR Part 139.

2. A “NIL” braking condition at these airports must be mitigated by closure of the affected surface. Do not include the type of vehicle in the FICON NOTAM.

c. When tower controllers receive runway braking action reports which include the terms medium, poor, or nil, or whenever weather conditions are conducive to deteriorating or rapidly changing runway braking conditions, the tower will include on the ATIS broadcast the statement, “**BRAKING ACTION ADVISORIES ARE IN EFFECT.**”

d. During the time that braking action advisories are in effect, ATC will issue the most recent braking action report for the runway in use to each arriving and departing aircraft. Pilots should be prepared for

deteriorating braking conditions and should request current runway condition information if not issued by controllers. Pilots should also be prepared to provide a descriptive runway condition report to controllers after landing.

4-3-9. Runway Condition Reports

a. Aircraft braking coefficient is dependent upon the surface friction between the tires on the aircraft wheels and the pavement surface. Less friction means less aircraft braking coefficient and less aircraft braking response.

b. Runway condition code (RwyCC) values range from 1 (poor) to 6 (dry). For frozen contaminants on runway surfaces, a runway condition code reading of 4 indicates the level when braking deceleration or directional control is between good and medium.

NOTE-

A RwyCC of “0” is used to delineate a braking action report of NIL and is prohibited from being reported in a FICON NOTAM.

c. Airport management should conduct runway condition assessments on wet runways or runways covered with compacted snow and/or ice.

1. Numerical readings may be obtained by using the Runway Condition Assessment Matrix (RCAM). The RCAM provides the airport operator with data to complete the report that includes the following:

- (a)** Runway(s) in use
- (b)** Time of the assessment
- (c)** Runway condition codes for each zone (touchdown, mid-point, roll-out)

(d) Pilot-reported braking action report (if available)

(e) The contaminant (for example, wet snow, dry snow, slush, ice, etc.)

2. Assessments for each zone (see 4-3-9c1(c)) will be issued in the direction of takeoff and landing on the runway, ranging from “1” to “6” to describe contaminated surfaces.

NOTE-

A RwyCC of “0” is used to delineate a braking action report of NIL and is prohibited from being reported in a FICON NOTAM.

3. When any 1 or more runway condition codes are reported as less than 6, airport management must notify ATC for dissemination to pilots.

4. Controllers will not issue runway condition codes when all 3 segments of a runway are reporting values of 6.

d. When runway condition code reports are provided by airport management, the ATC facility providing approach control or local airport advisory must provide the report to all pilots.

e. Pilots should use runway condition code information with other knowledge including aircraft performance characteristics, type, and weight, previous experience, wind conditions, and aircraft tire type (such as bias ply vs. radial constructed) to determine runway suitability.

f. The Runway Condition Assessment Matrix identifies the descriptive terms “good,” “good to medium,” “medium,” “medium to poor,” “poor,” and “nil” used in braking action reports.

REFERENCE-

Advisory Circular AC 91-79A (Revision 1), Mitigating the Risks of a Runway Overrun Upon Landing, Appendix 1

**FIG 4-3-7
Runway Condition Assessment Matrix (RCAM)**

Assessment Criteria		Control/Braking Assessment Criteria	
Runway Condition Description	RwyCC	Deceleration or Directional Control Observation	Pilot Reported Braking Action
<ul style="list-style-type: none"> • Dry 	6	---	---
<ul style="list-style-type: none"> • Frost • Wet (Includes damp and 1/8 inch depth or less of water) <p>1/8 inch (3mm) depth or less of:</p> <ul style="list-style-type: none"> • Slush • Dry Snow • Wet Snow 	5	Braking deceleration is normal for the wheel braking effort applied AND directional control is normal.	Good
<p>-15°C and Colder outside air temperature:</p> <ul style="list-style-type: none"> • Compacted Snow 	4	Braking deceleration OR directional control is between Good and Medium.	Good to Medium
<ul style="list-style-type: none"> • Slippery When Wet (wet runway) • Dry Snow or Wet Snow (any depth) over Compacted Snow <p>Greater than 1/8 inch (3 mm) depth of:</p> <ul style="list-style-type: none"> • Dry Snow • Wet Snow <p>Warmer than -15°C outside air temperature:</p> <ul style="list-style-type: none"> • Compacted Snow 	3	Braking deceleration is noticeably reduced for the wheel braking effort applied OR directional control is noticeably reduced.	Medium
<p>Greater than 1/8 inch(3 mm) depth of:</p> <ul style="list-style-type: none"> • Water • Slush 	2	Braking deceleration OR directional control is between Medium and Poor.	Medium to Poor
<ul style="list-style-type: none"> • Ice 	1	Braking deceleration is significantly reduced for the wheel braking effort applied OR directional control is significantly reduced.	Poor
<ul style="list-style-type: none"> • Wet Ice • Slush over Ice • Water over Compacted Snow • Dry Snow or Wet Snow over Ice 	0	Braking deceleration is minimal to non-existent for the wheel braking effort applied OR directional control is uncertain.	Nil

4-3-10. Intersection Takeoffs

a. In order to enhance airport capacities, reduce taxiing distances, minimize departure delays, and provide for more efficient movement of air traffic, controllers may initiate intersection takeoffs as well as approve them when the pilot requests. If for ANY reason a pilot prefers to use a different intersection or the full length of the runway or desires to obtain the distance between the intersection and the runway end, **THE PILOT IS EXPECTED TO INFORM ATC ACCORDINGLY.**

b. Pilots are expected to assess the suitability of an intersection for use at takeoff during their preflight planning. They must consider the resultant length reduction to the published runway length and to the published declared distances from the intersection intended to be used for takeoff. The minimum runway required for takeoff must fall within the reduced runway length and the reduced declared distances before the intersection can be accepted for takeoff.

REFERENCE-

AIM, Paragraph 4-3-6, Use of Runways/Declared Distances

c. Controllers will issue the measured distance from the intersection to the runway end rounded “down” to the nearest 50 feet to any pilot who requests and to all military aircraft, unless use of the intersection is covered in appropriate directives. Controllers, however, will not be able to inform pilots of the distance from the intersection to the end of any of the published declared distances.

REFERENCE-

FAA Order JO 7110.65, Paragraph 3-7-1, Ground Traffic Movement

d. An aircraft is expected to taxi to (but not onto) the end of the assigned runway unless prior approval for an intersection departure is received from ground control.

e. Pilots should state their position on the airport when calling the tower for takeoff from a runway intersection.

EXAMPLE-

Cleveland Tower, Apache Three Seven Two Two Papa, at the intersection of taxiway Oscar and runway two three right, ready for departure.

f. Controllers are required to separate small aircraft that are departing from an intersection on the same runway (same or opposite direction) behind a large nonheavy aircraft (except B757), by ensuring that at least a 3-minute interval exists between the

time the preceding large aircraft has taken off and the succeeding small aircraft begins takeoff roll. The 3-minute separation requirement will also be applied to small aircraft with a maximum certificated takeoff weight of 12,500 pounds or less departing behind a small aircraft with a maximum certificated takeoff weight of more than 12,500 pounds. To inform the pilot of the required 3-minute hold, the controller will state, “Hold for wake turbulence.” If after considering wake turbulence hazards, the pilot feels that a lesser time interval is appropriate, the pilot may request a waiver to the 3-minute interval. To initiate such a request, simply say “Request waiver to 3-minute interval” or a similar statement. Controllers may then issue a takeoff clearance if other traffic permits, since the pilot has accepted the responsibility for wake turbulence separation.

g. The 3-minute interval is not required when the intersection is 500 feet or less from the departure point of the preceding aircraft and both aircraft are taking off in the same direction. Controllers may permit the small aircraft to alter course after takeoff to avoid the flight path of the preceding departure.

h. A 4-minute interval is mandatory for small, large, and heavy aircraft behind a super aircraft. The 3-minute interval is mandatory behind a heavy aircraft in all cases, and for small aircraft behind a B757.

4-3-11. Pilot Responsibilities When Conducting Land and Hold Short Operations (LAHSO)

a. LAHSO is an acronym for “Land and Hold Short Operations.” These operations include landing and holding short of an intersecting runway, an intersecting taxiway, or some other designated point on a runway other than an intersecting runway or taxiway. (See FIG 4-3-8, FIG 4-3-9, FIG 4-3-10.)

b. Pilot Responsibilities and Basic Procedures.

1. LAHSO is an air traffic control procedure that requires pilot participation to balance the needs for increased airport capacity and system efficiency, consistent with safety. This procedure can be done safely provided pilots and controllers are knowledgeable and understand their responsibilities. The following paragraphs outline specific pilot/operator responsibilities when conducting LAHSO.

2. At controlled airports, air traffic may clear a pilot to land and hold short. Pilots may accept such a

clearance provided that the pilot-in-command determines that the aircraft can safely land and stop within the Available Landing Distance (ALD). ALD data are published in the special notices section of the Chart Supplement U.S. and in the U.S. Terminal Procedures Publications. Controllers will also provide ALD data upon request. Student pilots or pilots not familiar with LAHSO should not participate in the program.

3. The pilot-in-command has the final authority to accept or decline any land and hold short clearance. The safety and operation of the aircraft remain the responsibility of the pilot. Pilots are expected to decline a LAHSO clearance if they determine it will compromise safety.

4. To conduct LAHSO, pilots should become familiar with all available information concerning LAHSO at their destination airport. Pilots should have, *readily available*, the published ALD and runway slope information for all LAHSO runway combinations at each airport of intended landing. Additionally, knowledge about landing performance data permits the pilot to *readily* determine that the ALD for the assigned runway is sufficient for safe LAHSO. As part of a pilot's preflight planning process, pilots should determine if their destination airport has LAHSO. If so, their preflight planning process should include an assessment of which LAHSO combinations would work for them given their aircraft's required landing distance. Good pilot decision making is knowing in advance whether one can accept a LAHSO clearance if offered.

FIG 4-3-8
Land and Hold Short of an Intersecting Runway

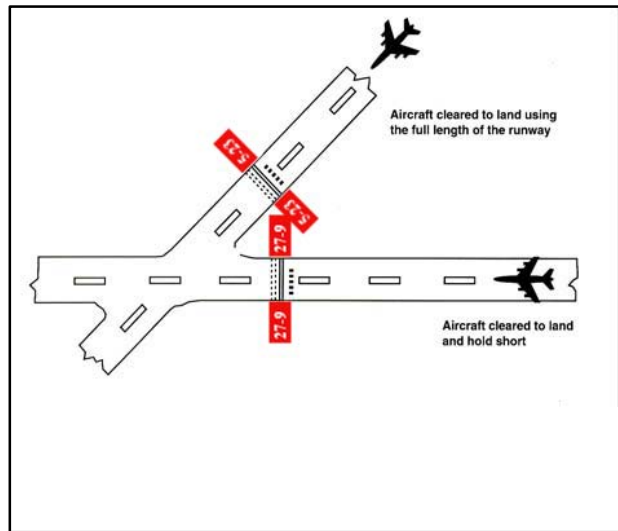

EXAMPLE-

FIG 4-3-10 – holding short at a designated point may be required to avoid conflicts with the runway safety area/flight path of a nearby runway.

NOTE-

Each figure shows the approximate location of LAHSO markings, signage, and in-pavement lighting when installed.

REFERENCE-

AIM, Chapter 2, Aeronautical Lighting and Other Airport Visual Aids.

FIG 4-3-9
Land and Hold Short of an Intersecting Taxiway

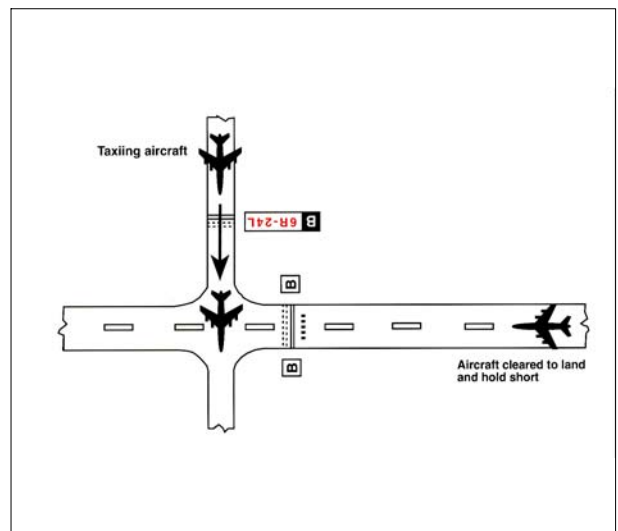
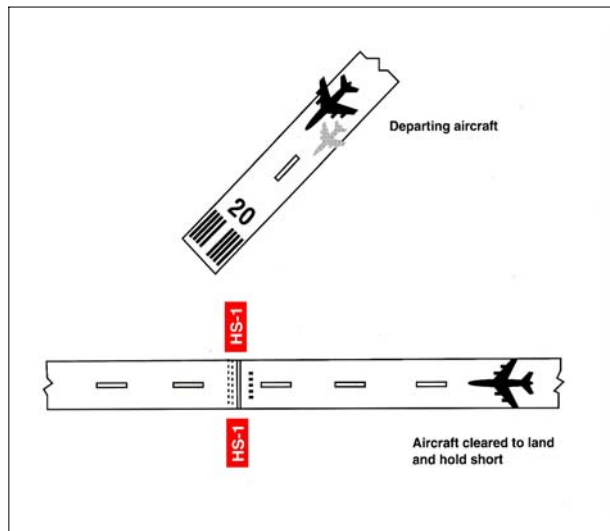

FIG 4-3-10
Land and Hold Short of a Designated Point
on a Runway Other Than an Intersecting
Runway or Taxiway



5. If, for any reason, such as difficulty in discerning the location of a LAHSO intersection, wind conditions, aircraft condition, etc., the pilot elects to request to land on the full length of the runway, to land on another runway, or to decline LAHSO, a pilot is expected to promptly inform air traffic, ideally even before the clearance is issued. A LAHSO clearance, once accepted, must be adhered to, just as any other ATC clearance, unless an amended clearance is obtained or an emergency occurs. A LAHSO clearance does not preclude a rejected landing.

6. A pilot who accepts a LAHSO clearance should land and exit the runway at the first convenient taxiway (unless directed otherwise) before reaching the hold short point. Otherwise, the pilot must stop and hold at the hold short point. If a rejected landing becomes necessary after accepting a LAHSO clearance, the pilot should maintain safe separation from other aircraft or vehicles, and should promptly notify the controller.

7. Controllers need a full read back of all LAHSO clearances. Pilots should read back their LAHSO clearance and include the words, “HOLD SHORT OF (RUNWAY/TAXIWAY/OR POINT)” in their acknowledgment of all LAHSO clearances. In order to reduce frequency congestion, pilots are encouraged to read back the LAHSO clearance

without prompting. Don’t make the controller have to ask for a read back!

c. LAHSO Situational Awareness

1. Situational awareness is vital to the success of LAHSO. Situational awareness starts with having current airport information in the cockpit, readily accessible to the pilot. (An airport diagram assists pilots in identifying their location on the airport, thus reducing requests for “progressive taxi instructions” from controllers.)

2. Situational awareness includes effective pilot-controller radio communication. ATC expects pilots to specifically acknowledge and read back all LAHSO clearances as follows:

EXAMPLE-

ATC: “(Aircraft ID) cleared to land runway six right, hold short of taxiway bravo for crossing traffic (type aircraft).”

Aircraft: “(Aircraft ID), wilco, cleared to land runway six right to hold short of taxiway bravo.”

ATC: “(Aircraft ID) cross runway six right at taxiway bravo, landing aircraft will hold short.”

Aircraft: “(Aircraft ID), wilco, cross runway six right at bravo, landing traffic (type aircraft) to hold.”

3. For those airplanes flown with two crewmembers, effective intra-cockpit communication between cockpit crewmembers is also critical. There have been several instances where the pilot working the radios accepted a LAHSO clearance but then simply forgot to tell the pilot flying the aircraft.

4. Situational awareness also includes a thorough understanding of the airport markings, signage, and lighting associated with LAHSO. These visual aids consist of a three-part system of yellow hold-short markings, red and white signage and, in certain cases, in-pavement lighting. Visual aids assist the pilot in determining where to hold short. FIG 4-3-8, FIG 4-3-9, FIG 4-3-10 depict how these markings, signage, and lighting combinations will appear once installed. Pilots are cautioned that not all airports conducting LAHSO have installed any or all of the above markings, signage, or lighting.

5. Pilots should only receive a LAHSO clearance when there is a minimum ceiling of 1,000 feet and 3 statute miles visibility. The intent of having “basic” VFR weather conditions is to allow pilots to maintain visual contact with other aircraft and ground vehicle operations. Pilots should consider the effects of prevailing inflight visibility (such as landing into the sun) and how it may affect overall

situational awareness. Additionally, surface vehicles and aircraft being taxied by maintenance personnel may also be participating in LAHSO, especially in those operations that involve crossing an active runway.

4-3-12. Low Approach

a. A low approach (sometimes referred to as a low pass) is the go-around maneuver following an approach. Instead of landing or making a touch-and-go, a pilot may wish to go around (low approach) in order to expedite a particular operation (a series of practice instrument approaches is an example of such an operation). Unless otherwise authorized by ATC, the low approach should be made straight ahead, with no turns or climb made until the pilot has made a thorough visual check for other aircraft in the area.

b. When operating within a Class B, Class C, and Class D surface area, a pilot intending to make a low approach should contact the tower for approval. This request should be made prior to starting the final approach.

c. When operating to an airport, not within a Class B, Class C, and Class D surface area, a pilot intending to make a low approach should, prior to leaving the final approach fix inbound (nonprecision approach) or the outer marker or fix used in lieu of the outer marker inbound (precision approach), so advise the FSS, UNICOM, or make a broadcast as appropriate.

REFERENCE-

AIM, Paragraph 4-1-9, Traffic Advisory Practices at Airports Without Operating Control Towers

4-3-13. Traffic Control Light Signals

a. The following procedures are used by ATCTs in the control of aircraft, ground vehicles, equipment,

and personnel not equipped with radio. These same procedures will be used to control aircraft, ground vehicles, equipment, and personnel equipped with radio if radio contact cannot be established. ATC personnel use a directive traffic control signal which emits an intense narrow light beam of a selected color (either red, white, or green) when controlling traffic by light signals.

b. Although the traffic signal light offers the advantage that some control may be exercised over nonradio equipped aircraft, pilots should be cognizant of the disadvantages which are:

1. Pilots may not be looking at the control tower at the time a signal is directed toward their aircraft.

2. The directions transmitted by a light signal are very limited since only approval or disapproval of a pilot's anticipated actions may be transmitted. No supplement or explanatory information may be transmitted except by the use of the "General Warning Signal" which advises the pilot to be on the alert.

c. Between sunset and sunrise, a pilot wishing to attract the attention of the control tower should turn on a landing light and taxi the aircraft into a position, clear of the active runway, so that light is visible to the tower. The landing light should remain on until appropriate signals are received from the tower.

d. Airport Traffic Control Tower Light Gun Signals. (See TBL 4-3-1.)

e. During daylight hours, acknowledge tower transmissions or light signals by moving the ailerons or rudder. At night, acknowledge by blinking the landing or navigation lights. If radio malfunction occurs after departing the parking area, watch the tower for light signals or monitor tower frequency.

TBL 4-3-1
Airport Traffic Control Tower Light Gun Signals

Meaning			
Color and Type of Signal	Movement of Vehicles, Equipment and Personnel	Aircraft on the Ground	Aircraft in Flight
Steady green	Cleared to cross, proceed or go	Cleared for takeoff	Cleared to land
Flashing green	Not applicable	Cleared for taxi	Return for landing (to be followed by steady green at the proper time)
Steady red	STOP	STOP	Give way to other aircraft and continue circling
Flashing red	Clear the taxiway/runway	Taxi clear of the runway in use	Airport unsafe, do not land
Flashing white	Return to starting point on airport	Return to starting point on airport	Not applicable
Alternating red and green	Exercise extreme caution	Exercise extreme caution	Exercise extreme caution

4-3-14. Communications

a. Pilots of departing aircraft should communicate with the control tower on the appropriate ground control/clearance delivery frequency prior to starting engines to receive engine start time, taxi and/or clearance information. Unless otherwise advised by the tower, remain on that frequency during taxiing and runup, then change to local control frequency when ready to request takeoff clearance.

NOTE-

Pilots are encouraged to monitor the local tower frequency as soon as practical consistent with other ATC requirements.

REFERENCE-

AIM, Paragraph 4-1-13, Automatic Terminal Information Service (ATIS)

b. The tower controller will consider that pilots of turbine-powered aircraft are ready for takeoff when they reach the runway or warm-up block unless advised otherwise.

c. The majority of ground control frequencies are in the 121.6-121.9 MHz bandwidth. Ground control frequencies are provided to eliminate frequency congestion on the tower (local control) frequency and are limited to communications between the tower and aircraft on the ground and between the tower and utility vehicles on the airport, provide a clear VHF channel for arriving and departing aircraft. They are used for issuance of taxi information, clearances, and other necessary contacts between the tower and aircraft or other vehicles operated on the airport. A pilot who has just landed should not change from the

tower frequency to the ground control frequency until directed to do so by the controller. Normally, only one ground control frequency is assigned at an airport; however, at locations where the amount of traffic so warrants, a second ground control frequency and/or another frequency designated as a clearance delivery frequency, may be assigned.

d. A controller may omit the ground or local control frequency if the controller believes the pilot knows which frequency is in use. If the ground control frequency is in the 121 MHz bandwidth the controller may omit the numbers preceding the decimal point; e.g., 121.7, "CONTACT GROUND POINT SEVEN." However, if any doubt exists as to what frequency is in use, the pilot should promptly request the controller to provide that information.

e. Controllers will normally avoid issuing a radio frequency change to helicopters, known to be single-piloted, which are hovering, air taxiing, or flying near the ground. At times, it may be necessary for pilots to alert ATC regarding single pilot operations to minimize delay of essential ATC communications. Whenever possible, ATC instructions will be relayed through the frequency being monitored until a frequency change can be accomplished. You must promptly advise ATC if you are unable to comply with a frequency change. Also, you should advise ATC if you must land to accomplish the frequency change unless it is clear the landing will have no impact on other air traffic; e.g., on a taxiway or in a helicopter operating area.

4-3-15. Gate Holding Due to Departure Delays

a. Pilots should contact ground control or clearance delivery prior to starting engines as gate hold procedures will be in effect whenever departure delays exceed or are anticipated to exceed 15 minutes. The sequence for departure will be maintained in accordance with initial call up unless modified by flow control restrictions. Pilots should monitor the ground control or clearance delivery frequency for engine startup advisories or new proposed start time if the delay changes.

b. The tower controller will consider that pilots of turbine-powered aircraft are ready for takeoff when they reach the runway or warm-up block unless advised otherwise.

4-3-16. VFR Flights in Terminal Areas

Use reasonable restraint in exercising the prerogative of VFR flight, especially in terminal areas. The weather minimums and distances from clouds are minimums. Giving yourself a greater margin in specific instances is just good judgment.

a. Approach Area. Conducting a VFR operation in a Class B, Class C, Class D, and Class E surface area when the official visibility is 3 or 4 miles is not prohibited, but good judgment would dictate that you keep out of the approach area.

b. Reduced Visibility. It has always been recognized that precipitation reduces forward visibility. Consequently, although again it may be perfectly legal to cancel your IFR flight plan at any time you can proceed VFR, it is good practice, when precipitation is occurring, to continue IFR operation into a terminal area until you are reasonably close to your destination.

c. Simulated Instrument Flights. In conducting simulated instrument flights, be sure that the weather is good enough to compensate for the restricted visibility of the safety pilot and your greater concentration on your flight instruments. Give yourself a little greater margin when your flight plan lies in or near a busy airway or close to an airport.

4-3-17. VFR Helicopter Operations at Controlled Airports

a. General.

1. The following ATC procedures and phraseologies recognize the unique capabilities of helicopters and were developed to improve service to all users. Helicopter design characteristics and user needs often require operations from movement areas and nonmovement areas within the airport boundary. In order for ATC to properly apply these procedures, it is essential that pilots familiarize themselves with the local operations and make it known to controllers when additional instructions are necessary.

2. Insofar as possible, helicopter operations will be instructed to avoid the flow of fixed-wing aircraft to minimize overall delays; however, there will be many situations where faster/larger helicopters may be integrated with fixed-wing aircraft for the benefit of all concerned. Examples would include IFR flights, avoidance of noise sensitive areas, or use of runways/taxiways to minimize the hazardous effects of rotor downwash in congested areas.

3. Because helicopter pilots are intimately familiar with the effects of rotor downwash, they are best qualified to determine if a given operation can be conducted safely. Accordingly, the pilot has the final authority with respect to the specific airspeed/altitude combinations. ATC clearances are in no way intended to place the helicopter in a hazardous position. It is expected that pilots will advise ATC if a specific clearance will cause undue hazards to persons or property.

b. Controllers normally limit ATC ground service and instruction to *movement* areas; therefore, operations from *nonmovement* areas are conducted at pilot discretion and should be based on local policies, procedures, or letters of agreement. In order to maximize the flexibility of helicopter operations, it is necessary to rely heavily on sound pilot judgment. For example, hazards such as debris, obstructions, vehicles, or personnel must be recognized by the pilot, and action should be taken as necessary to avoid such hazards. Taxi, hover taxi, and air taxi operations are considered to be ground movements. Helicopters conducting such operations are expected to adhere to the same conditions, requirements, and practices as apply to other ground taxiing and ATC procedures in the AIM.

1. The phraseology *taxi* is used when it is intended or expected that the helicopter will taxi on the airport surface, either via taxiways or other prescribed routes. *Taxi* is used primarily for helicopters equipped with wheels or in response to a

pilot request. Preference should be given to this procedure whenever it is necessary to minimize effects of rotor downwash.

2. Pilots may request a *hover taxi* when slow forward movement is desired or when it may be appropriate to move very short distances. Pilots should avoid this procedure if rotor downwash is likely to cause damage to parked aircraft or if blowing dust/snow could obscure visibility. If it is necessary to operate above 25 feet AGL when hover taxiing, the pilot should initiate a request to ATC.

3. *Air taxi* is the preferred method for helicopter ground movements on airports provided ground operations and conditions permit. Unless otherwise requested or instructed, pilots are expected to remain below 100 feet AGL. However, if a higher than normal airspeed or altitude is desired, the request should be made prior to lift-off. The pilot is solely responsible for selecting a safe airspeed for the altitude/operation being conducted. Use of *air taxi* enables the pilot to proceed at an optimum airspeed/altitude, minimize downwash effect, conserve fuel, and expedite movement from one point to another. Helicopters should avoid overflight of other aircraft, vehicles, and personnel during air-taxi operations. Caution must be exercised concerning active runways and pilots must be certain that air taxi instructions are understood. Special precautions may be necessary at unfamiliar airports or airports with multiple/intersecting active runways. The taxi procedures given in Paragraph 4-3-18, Taxiing, Paragraph 4-3-19, Taxi During Low Visibility, and Paragraph 4-3-20, Exiting the Runway After Landing, also apply.

REFERENCE-

Pilot/Controller Glossary Term- Taxi.

Pilot/Controller Glossary Term- Hover Taxi.

Pilot/Controller Glossary Term- Air Taxi.

c. Takeoff and Landing Procedures.

1. Helicopter operations may be conducted from a runway, taxiway, portion of a landing strip, or any clear area which could be used as a landing site such as the scene of an accident, a construction site, or the roof of a building. The terms used to describe designated areas from which helicopters operate are: movement area, landing/takeoff area, apron/ramp, heliport and helipad (See Pilot/Controller Glossary).

These areas may be improved or unimproved and may be separate from or located on an airport/heliport. ATC will issue takeoff clearances from *movement* areas other than active runways, or in diverse directions from active runways, with additional instructions as necessary. Whenever possible, takeoff clearance will be issued in lieu of extended hover/air taxi operations. Phraseology will be “CLEARED FOR TAKEOFF FROM (taxiway, helipad, runway number, etc.), MAKE RIGHT/LEFT TURN FOR (direction, heading, NAVAID radial) DEPARTURE/DEPARTURE ROUTE (number, name, etc.)” Unless requested by the pilot, downwind takeoffs will not be issued if the tailwind exceeds 5 knots.

2. Pilots should be alert to wind information as well as to wind indications in the vicinity of the helicopter. ATC should be advised of the intended method of departing. A pilot request to takeoff in a given direction indicates that the pilot is willing to accept the wind condition and controllers will honor the request if traffic permits. Departure points could be a significant distance from the control tower and it may be difficult or impossible for the controller to determine the helicopter’s relative position to the wind.

3. If takeoff is requested from *nonmovement* areas, an area not authorized for helicopter use, an area not visible from the tower, an unlighted area at night, or an area off the airport, the phraseology “DEPARTURE FROM (requested location) WILL BE AT YOUR OWN RISK (additional instructions, as necessary). USE CAUTION (if applicable).” The pilot is responsible for operating in a safe manner and should exercise due caution.

4. Similar phraseology is used for helicopter landing operations. Every effort will be made to permit helicopters to proceed direct and land as near as possible to their final destination on the airport. Traffic density, the need for detailed taxiing instructions, frequency congestion, or other factors may affect the extent to which service can be expedited. As with ground movement operations, a high degree of pilot/controller cooperation and communication is necessary to achieve safe and efficient operations.

4-3-18. Taxiing

a. General. Approval must be obtained prior to moving an aircraft or vehicle onto the movement area during the hours an Airport Traffic Control Tower is in operation.

1. Always state your position on the airport when calling the tower for taxi instructions.

2. The movement area is normally described in local bulletins issued by the airport manager or control tower. These bulletins may be found in FSSs, fixed base operators offices, air carrier offices, and operations offices.

3. The control tower also issues bulletins describing areas where they cannot provide ATC service due to nonvisibility or other reasons.

4. A clearance must be obtained prior to taxiing on a runway, taking off, or landing during the hours an Airport Traffic Control Tower is in operation.

5. A clearance must be obtained prior to crossing any runway. ATC will issue an explicit clearance for all runway crossings.

6. When assigned a takeoff runway, ATC will first specify the runway, issue taxi instructions, and state any hold short instructions or runway crossing clearances if the taxi route will cross a runway. This does not authorize the aircraft to “enter” or “cross” the assigned departure runway at any point. In order to preclude misunderstandings in radio communications, ATC will not use the word “cleared” in conjunction with authorization for aircraft to taxi.

7. When issuing taxi instructions to any point other than an assigned takeoff runway, ATC will specify the point to taxi to, issue taxi instructions, and state any hold short instructions or runway crossing clearances if the taxi route will cross a runway.

NOTE-

ATC is required to obtain a readback from the pilot of all runway hold short instructions.

8. If a pilot is expected to hold short of a runway approach/departure (*Runway XX APPCH/Runway XX DEP*) hold area or ILS holding position (see FIG 2-3-15, Taxiways Located in Runway Approach Area), ATC will issue instructions.

9. When taxi instructions are received from the controller, pilots should always read back:

(a) The runway assignment.

(b) Any clearance to enter a specific runway.

(c) Any instruction to hold short of a specific runway or line up and wait.

10. Controllers are required to request a readback of runway hold short assignment when it is not received from the pilot/vehicle.

b. ATC clearances or instructions pertaining to taxiing are predicated on known traffic and known physical airport conditions. Therefore, it is important that pilots clearly understand the clearance or instruction. Although an ATC clearance is issued for taxiing purposes, when operating in accordance with the CFRs, it is the responsibility of the pilot to avoid collision with other aircraft. Since “the pilot-in-command of an aircraft is directly responsible for, and is the final authority as to, the operation of that aircraft” the pilot should obtain clarification of any clearance or instruction which is not understood.

REFERENCE-

AIM, Paragraph 7-3-1, General

1. Good operating practice dictates that pilots acknowledge all runway crossing, hold short, or takeoff clearances unless there is some misunderstanding, at which time the pilot should query the controller until the clearance is understood.

NOTE-

Air traffic controllers are required to obtain from the pilot a readback of all runway hold short instructions.

2. Pilots operating a single pilot aircraft should monitor only assigned ATC communications after being cleared onto the active runway for departure. Single pilot aircraft should not monitor other than ATC communications until flight from Class B, Class C, or Class D surface area is completed. This same procedure should be practiced from after receipt of the clearance for landing until the landing and taxi activities are complete. Proper effective scanning for other aircraft, surface vehicles, or other objects should be continuously exercised in all cases.

3. If the pilot is unfamiliar with the airport or for any reason confusion exists as to the correct taxi routing, a request may be made for progressive taxi instructions which include step-by-step routing directions. Progressive instructions may also be issued if the controller deems it necessary due to traffic or field conditions (for example, construction or closed taxiways).

c. At those airports where the U.S. Government operates the control tower and ATC has authorized noncompliance with the requirement for two-way radio communications while operating within the Class B, Class C, or Class D surface area, or at those airports where the U.S. Government does not operate the control tower and radio communications cannot be established, pilots must obtain a clearance by visual light signal prior to taxiing on a runway and prior to takeoff and landing.

d. The following phraseologies and procedures are used in radiotelephone communications with aeronautical ground stations.

1. Request for taxi instructions prior to departure. State your aircraft identification, location, type of operation planned (VFR or IFR), and the point of first intended landing.

EXAMPLE–

Aircraft: “Washington ground, Beechcraft One Three One Five Niner at hangar eight, ready to taxi, I–F–R to Chicago.”

Tower: “Beechcraft one three one five niner, Washington ground, runway two seven, taxi via taxiways Charlie and Delta, hold short of runway three three left.”

Aircraft: “Beechcraft One Three One Five Niner, hold short of runway three three left.”

2. Receipt of ATC clearance. ARTCC clearances are relayed to pilots by airport traffic controllers in the following manner.

EXAMPLE–

Tower: “Beechcraft One Three One Five Niner, cleared to the Chicago Midway Airport via Victor Eight, maintain eight thousand.”

Aircraft: “Beechcraft One Three One Five Niner, cleared to the Chicago Midway Airport via Victor Eight, maintain eight thousand.”

NOTE–

Normally, an ATC IFR clearance is relayed to a pilot by the ground controller. At busy locations, however, pilots may be instructed by the ground controller to “contact clearance delivery” on a frequency designated for this purpose. No surveillance or control over the movement of traffic is exercised by this position of operation.

3. Request for taxi instructions after landing. State your aircraft identification, location, and that you request taxi instructions.

EXAMPLE–

Aircraft: “Dulles ground, Beechcraft One Four Two Six One clearing runway one right on taxiway echo three, request clearance to Page.”

Tower: “Beechcraft One Four Two Six One, Dulles ground, taxi to Page via taxiways echo three, echo one, and echo niner.”

or

Aircraft: “Orlando ground, Beechcraft One Four Two Six One clearing runway one eight left at taxiway bravo three, request clearance to Page.”

Tower: “Beechcraft One Four Two Six One, Orlando ground, hold short of runway one eight right.”

Aircraft: “Beechcraft One Four Two Six One, hold short of runway one eight right.”

e. During ground operations, jet blast, prop wash, and rotor wash can cause damage and upsets if encountered at close range. Pilots should consider the effects of jet blast, prop wash, and rotor wash on aircraft, vehicles, and maintenance equipment during ground operations.

4–3–19. Taxi During Low Visibility

a. Pilots and aircraft operators should be constantly aware that during certain low visibility conditions the movement of aircraft and vehicles on airports may not be visible to the tower controller. This may prevent visual confirmation of an aircraft’s adherence to taxi instructions.

b. Of vital importance is the need for pilots to notify the controller when difficulties are encountered or at the first indication of becoming disoriented. Pilots should proceed with extreme caution when taxiing toward the sun. When vision difficulties are encountered pilots should immediately inform the controller.

c. Advisory Circular 120–57, Low Visibility Operations Surface Movement Guidance and Control System, commonly known as LVOSMGCS (pronounced “LVO SMIGS”) describes an adequate example of a low visibility taxi plan for any airport which has takeoff or landing operations in less than 1,200 feet runway visual range (RVR) visibility conditions. These plans, which affect aircrew and vehicle operators, may incorporate additional lighting, markings, and procedures to control airport

surface traffic. They will be addressed at two levels; operations less than 1,200 feet RVR to 500 feet RVR and operations less than 500 feet RVR.

NOTE–

Specific lighting systems and surface markings may be found in Paragraph 2-1-11, Taxiway Lights, and Paragraph 2-3-4, Taxiway Markings.

d. When low visibility conditions exist, pilots should focus their entire attention on the safe operation of the aircraft while it is moving. Checklists and nonessential communication should be withheld until the aircraft is stopped and the brakes set.

4-3-20. Exiting the Runway After Landing

The following procedures must be followed after landing and reaching taxi speed.

a. Exit the runway without delay at the first available taxiway or on a taxiway as instructed by ATC. Pilots must not exit the landing runway onto another runway unless authorized by ATC. At airports with an operating control tower, pilots should not stop or reverse course on the runway without first obtaining ATC approval.

b. Taxi clear of the runway unless otherwise directed by ATC. An aircraft is considered clear of the runway when all parts of the aircraft are past the runway edge and there are no restrictions to its continued movement beyond the runway holding position markings. In the absence of ATC instructions, the pilot is expected to taxi clear of the landing runway by taxiing beyond the runway holding position markings associated with the landing runway, even if that requires the aircraft to protrude into or cross another taxiway or ramp area. Once all parts of the aircraft have crossed the runway holding position markings, the pilot must hold unless further instructions have been issued by ATC.

NOTE–

1. *The tower will issue the pilot instructions which will permit the aircraft to enter another taxiway, runway, or ramp area when required.*

2. *Guidance contained in subparagraphs a and b above is considered an integral part of the landing clearance and satisfies the requirement of 14 CFR Section 91.129.*

c. Immediately change to ground control frequency when advised by the tower and obtain a taxi clearance.

NOTE–

1. *The tower will issue instructions required to resolve any potential conflicts with other ground traffic prior to advising the pilot to contact ground control.*

2. *Ground control will issue taxi clearance to parking. That clearance does not authorize the aircraft to “enter” or “cross” any runways. Pilots not familiar with the taxi route should request specific taxi instructions from ATC.*

4-3-21. Practice Instrument Approaches

a. Various air traffic incidents have indicated the necessity for adoption of measures to achieve more organized and controlled operations where practice instrument approaches are conducted. Practice instrument approaches are considered to be instrument approaches made by either a VFR aircraft not on an IFR flight plan or an aircraft on an IFR flight plan. To achieve this and thereby enhance air safety, it is Air Traffic’s policy to provide for separation of such operations at locations where approach control facilities are located and, as resources permit, at certain other locations served by ARTCCs or parent approach control facilities. Pilot requests to practice instrument approaches may be approved by ATC subject to traffic and workload conditions. Pilots should anticipate that in some instances the controller may find it necessary to deny approval or withdraw previous approval when traffic conditions warrant. It must be clearly understood, however, that even though the controller may be providing separation, pilots on VFR flight plans are required to comply with basic VFR weather minimums (14 CFR Section 91.155). Application of ATC procedures or any action taken by the controller to avoid traffic conflicts does not relieve IFR and VFR pilots of their responsibility to see-and-avoid other traffic while operating in VFR conditions (14 CFR Section 91.113). In addition to the normal IFR separation minimums (which includes visual separation) during VFR conditions, 500 feet vertical separation may be applied between VFR aircraft and between a VFR aircraft and the IFR aircraft. Pilots not on IFR flight plans desiring practice instrument approaches should always state ‘practice’ when making requests to ATC. Controllers will instruct VFR aircraft requesting an instrument approach to maintain VFR. This is to preclude misunderstandings between the pilot and controller as to the status of the aircraft. If pilots wish to proceed in accordance with instrument flight rules, they must specifically request and obtain, an IFR clearance.

b. Before practicing an instrument approach, pilots should inform the approach control facility or the tower of the type of practice approach they desire to make and how they intend to terminate it, i.e., full-stop landing, touch-and-go, or missed or low approach maneuver. This information may be furnished progressively when conducting a series of approaches. Pilots on an IFR flight plan, who have made a series of instrument approaches to full stop landings should inform ATC when they make their final landing. The controller will control flights practicing instrument approaches so as to ensure that they do not disrupt the flow of arriving and departing itinerant IFR or VFR aircraft. The priority afforded itinerant aircraft over practice instrument approaches is not intended to be so rigidly applied that it causes grossly inefficient application of services. A minimum delay to itinerant traffic may be appropriate to allow an aircraft practicing an approach to complete that approach.

NOTE-

A clearance to land means that appropriate separation on the landing runway will be ensured. A landing clearance does not relieve the pilot from compliance with any previously issued restriction.

c. At airports without a tower, pilots wishing to make practice instrument approaches should notify the facility having control jurisdiction of the desired approach as indicated on the approach chart. All approach control facilities and ARTCCs are required to publish a Letter to Airmen depicting those airports where they provide standard separation to both VFR and IFR aircraft conducting practice instrument approaches.

d. The controller will provide approved separation between both VFR and IFR aircraft when authorization is granted to make practice approaches to airports where an approach control facility is located and to certain other airports served by approach control or an ARTCC. Controller responsibility for separation of VFR aircraft begins at the point where the approach clearance becomes effective, or when the aircraft enters Class B or Class C airspace, or a TRSA, whichever comes first.

e. VFR aircraft practicing instrument approaches are not automatically authorized to execute the missed approach procedure. This authorization must be specifically requested by the pilot and approved by the controller. Where ATC procedures require

application of IFR separation to VFR aircraft practicing instrument approaches, separation will be provided throughout the procedure including the missed approach. Where no separation services are provided during the practice approach, no separation services will be provided during the missed approach.

f. Except in an emergency, aircraft cleared to practice instrument approaches must not deviate from the approved procedure until cleared to do so by the controller.

g. At radar approach control locations when a full approach procedure (procedure turn, etc.) cannot be approved, pilots should expect to be vectored to a final approach course for a practice instrument approach which is compatible with the general direction of traffic at that airport.

h. When granting approval for a practice instrument approach, the controller will usually ask the pilot to report to the tower prior to or over the final approach fix inbound (nonprecision approaches) or over the outer marker or fix used in lieu of the outer marker inbound (precision approaches).

i. When authorization is granted to conduct practice instrument approaches to an airport with a tower, but where approved standard separation is not provided to aircraft conducting practice instrument approaches, the tower will approve the practice approach, instruct the aircraft to maintain VFR and issue traffic information, as required.

j. When an aircraft notifies a FSS providing Local Airport Advisory to the airport concerned of the intent to conduct a practice instrument approach and whether or not separation is to be provided, the pilot will be instructed to contact the appropriate facility on a specified frequency prior to initiating the approach. At airports where separation is not provided, the FSS will acknowledge the message and issue known traffic information but will neither approve or disapprove the approach.

k. Pilots conducting practice instrument approaches should be particularly alert for other aircraft operating in the local traffic pattern or in proximity to the airport.

4-3-22. Option Approach

The “Cleared for the Option” procedure will permit an instructor, flight examiner or pilot the option to make a touch-and-go, low approach, missed

approach, stop-and-go, or full stop landing. This procedure can be very beneficial in a training situation in that neither the student pilot nor examinee would know what maneuver would be accomplished. The pilot should make a request for this procedure passing the final approach fix inbound on an instrument approach or entering downwind for a VFR traffic pattern. After ATC approval of the option, the pilot should inform ATC as soon as possible of any delay on the runway during their stop-and-go or full stop landing. The advantages of this procedure as a training aid are that it enables an instructor or examiner to obtain the reaction of a trainee or examinee under changing conditions, the pilot would not have to discontinue an approach in the middle of the procedure due to student error or pilot proficiency requirements, and finally it allows more flexibility and economy in training programs. This procedure will only be used at those locations with an operational control tower and will be subject to ATC approval.

4-3-23. Use of Aircraft Lights

a. Aircraft position lights are required to be lighted on aircraft operated on the surface and in flight from sunset to sunrise. In addition, aircraft equipped with an anti-collision light system are required to operate that light system during all types of operations (day and night). However, during any adverse meteorological conditions, the pilot-in-command may determine that the anti-collision lights should be turned off when their light output would constitute a hazard to safety (14 CFR Section 91.209). Supplementary strobe lights should be turned off on the ground when they adversely affect ground personnel or other pilots, and in flight when there are adverse reflection from clouds.

b. An aircraft anti-collision light system can use one or more rotating beacons and/or strobe lights, be colored either red or white, and have different (higher than minimum) intensities when compared to other aircraft. Many aircraft have both a rotating beacon and a strobe light system.

c. The FAA has a voluntary pilot safety program, Operation Lights On, to enhance the *see-and-avoid* concept. Pilots are encouraged to turn on their landing lights during takeoff; i.e., either after takeoff clearance has been received or when beginning takeoff roll. Pilots are further encouraged to turn on

their landing lights when operating below 10,000 feet, day or night, especially when operating within 10 miles of any airport, or in conditions of reduced visibility and in areas where flocks of birds may be expected, i.e., coastal areas, lake areas, around refuse dumps, etc. Although turning on aircraft lights does enhance the *see-and-avoid* concept, pilots should not become complacent about keeping a sharp lookout for other aircraft. Not all aircraft are equipped with lights and some pilots may not have their lights turned on. Aircraft manufacturer's recommendations for operation of landing lights and electrical systems should be observed.

d. Prop and jet blast forces generated by large aircraft have overturned or damaged several smaller aircraft taxiing behind them. To avoid similar results, and in the interest of preventing upsets and injuries to ground personnel from such forces, the FAA recommends that air carriers and commercial operators turn on their rotating beacons anytime their aircraft engines are in operation. General aviation pilots using rotating beacon equipped aircraft are also encouraged to participate in this program which is designed to alert others to the potential hazard. Since this is a voluntary program, exercise caution and do not rely solely on the rotating beacon as an indication that aircraft engines are in operation.

e. Prior to commencing taxi, it is recommended to turn on navigation, position, anti-collision, and logo lights (if equipped). To signal intent to other pilots, consider turning on the taxi light when the aircraft is moving or intending to move on the ground, and turning it off when stopped or yielding to other ground traffic. Strobe lights should not be illuminated during taxi if they will adversely affect the vision of other pilots or ground personnel.

f. At the discretion of the pilot-in-command, all exterior lights should be illuminated when taxiing on or across any runway. This increases the conspicuity of the aircraft to controllers and other pilots approaching to land, taxiing, or crossing the runway. Pilots should comply with any equipment operating limitations and consider the effects of landing and strobe lights on other aircraft in their vicinity.

g. When entering the departure runway for takeoff or to "line up and wait," all lights, except for landing lights, should be illuminated to make the aircraft conspicuous to ATC and other aircraft on approach. Landing lights should be turned on when takeoff

clearance is received or when commencing takeoff roll at an airport without an operating control tower.

4-3-24. Flight Inspection/‘Flight Check’ Aircraft in Terminal Areas

a. *Flight check* is a call sign used to alert pilots and air traffic controllers when a FAA aircraft is engaged in flight inspection/certification of NAVAIDs and flight procedures. Flight check aircraft fly preplanned high/low altitude flight patterns such as grids, orbits, DME arcs, and tracks, including low passes along the full length of the runway to verify NAVAID performance.

b. Pilots should be especially watchful and avoid the flight paths of any aircraft using the call sign “Flight Check.” These flights will normally receive special handling from ATC. Pilot patience and cooperation in allowing uninterrupted recordings can significantly help expedite flight inspections, minimize costly, repetitive runs, and reduce the burden on the U.S. taxpayer.

4-3-25. Hand Signals

FIG 4-3-11
Signalman Directs Towing

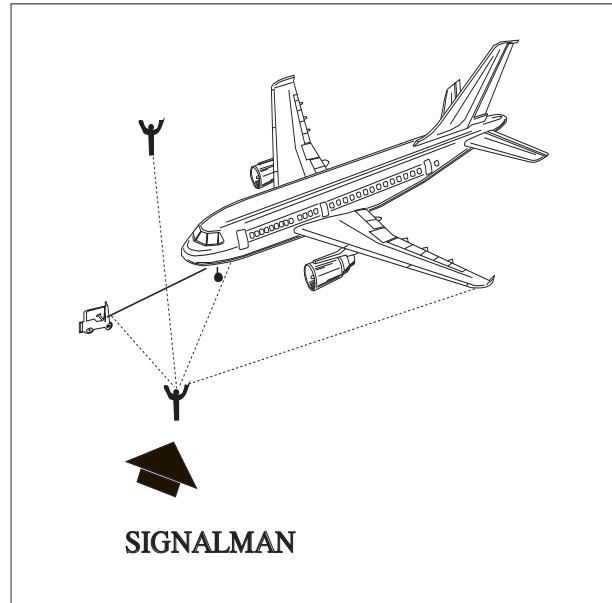

FIG 4-3-12
Signalman's Position

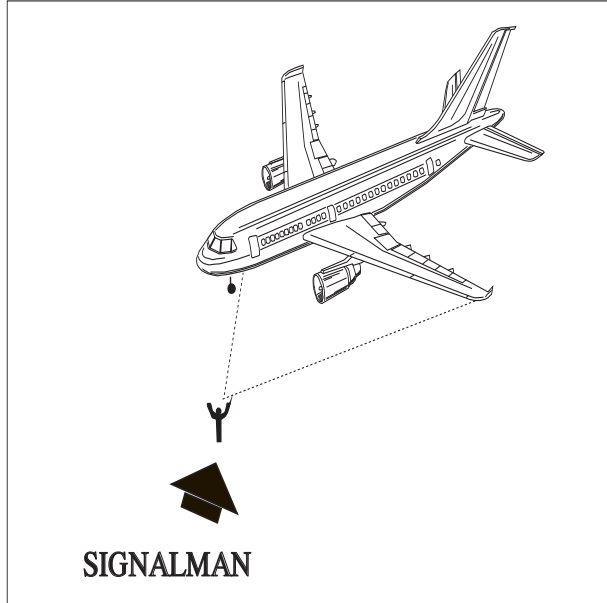

FIG 4-3-14
Start Engine

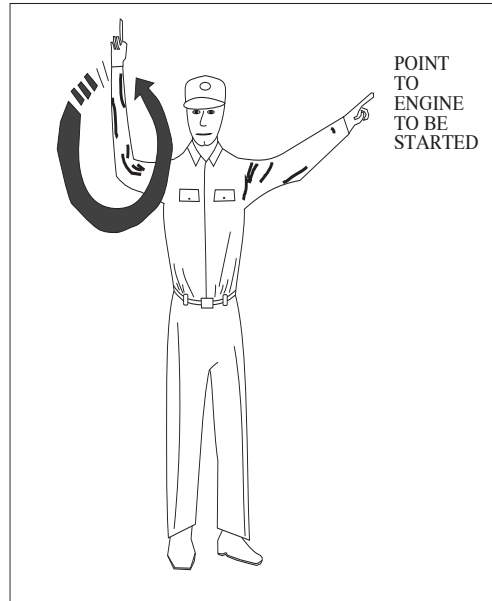

FIG 4-3-13
All Clear
(O.K.)

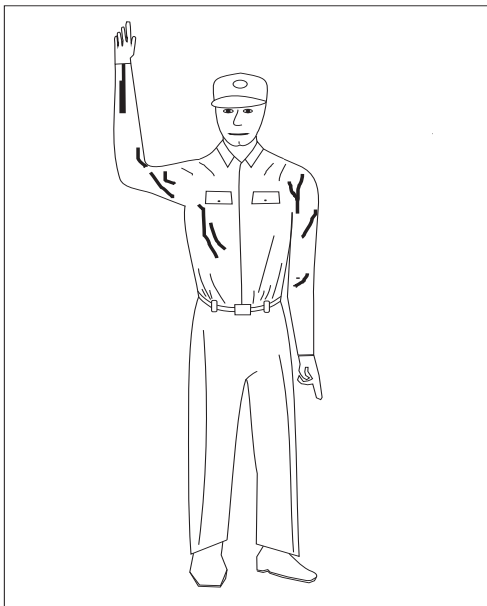

FIG 4-3-15
Pull Chocks

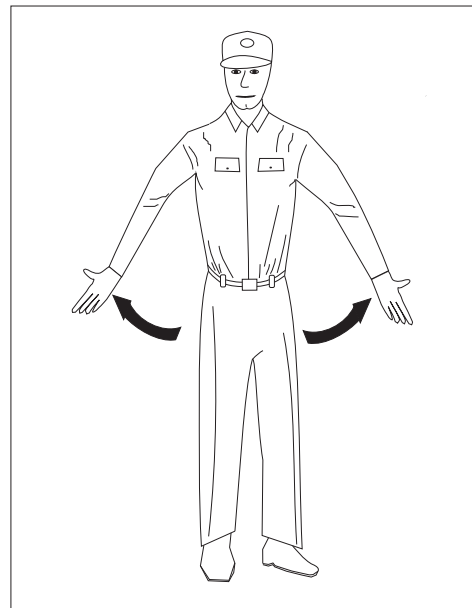

FIG 4-3-16
Proceed Straight Ahead

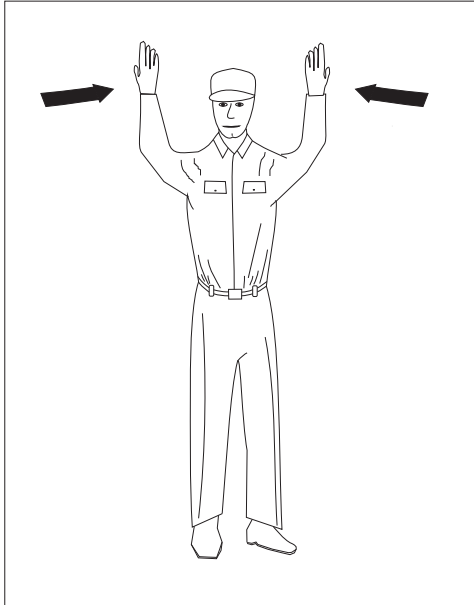

FIG 4-3-18
Right Turn

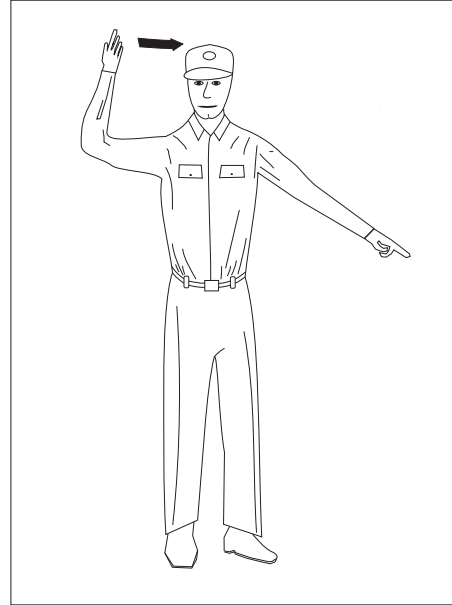

FIG 4-3-17
Left Turn

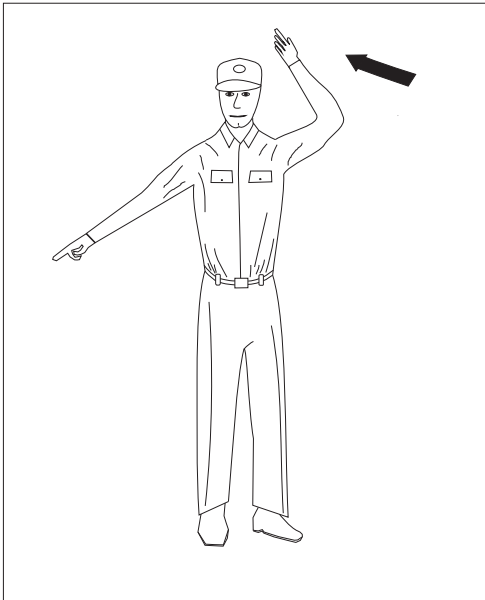

FIG 4-3-19
Slow Down

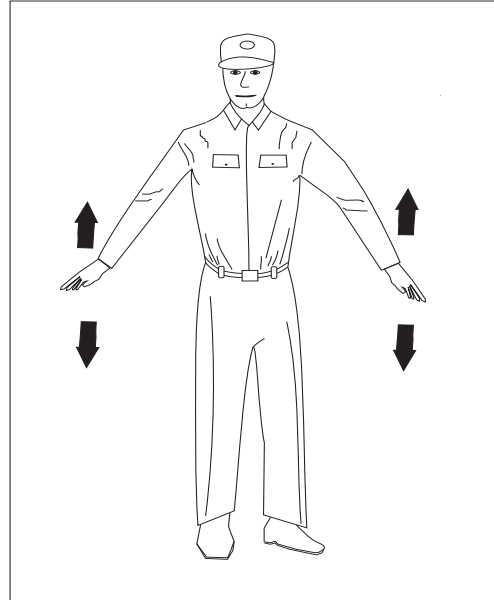

FIG 4-3-20
Flagman Directs Pilot

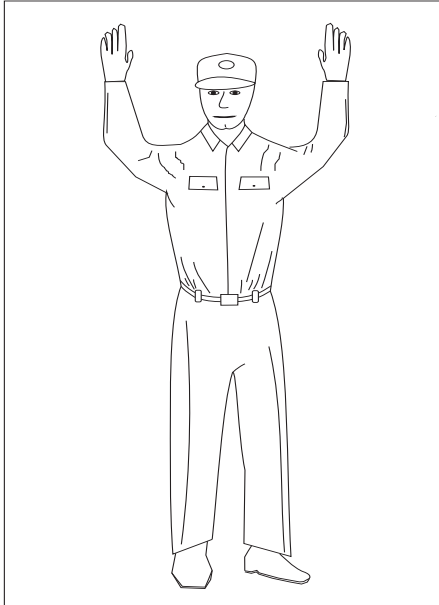

FIG 4-3-22
Cut Engines

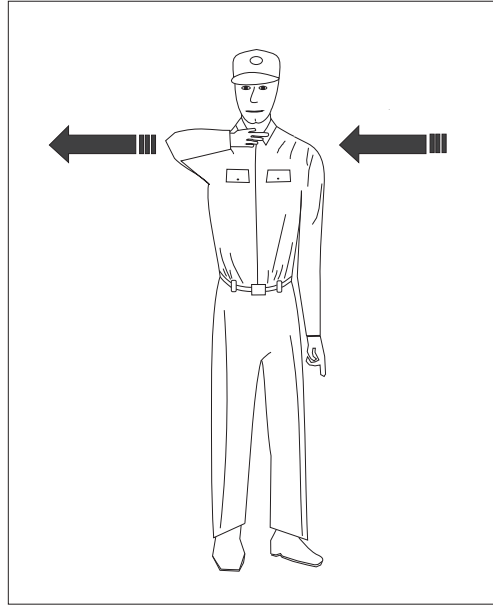

FIG 4-3-21
Insert Chocks

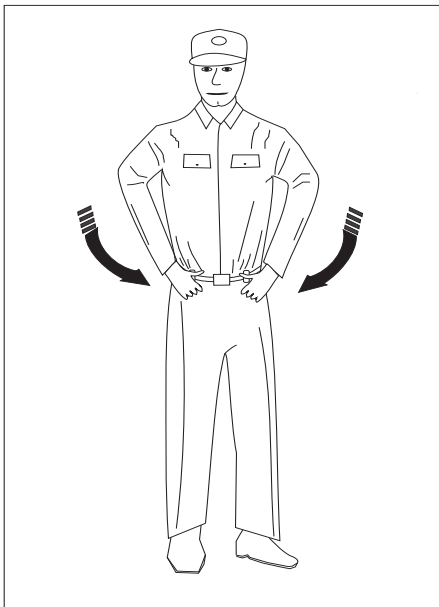

FIG 4-3-23
Night Operation

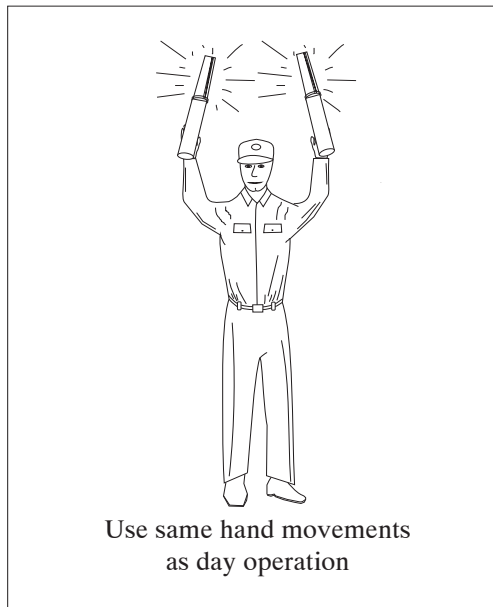
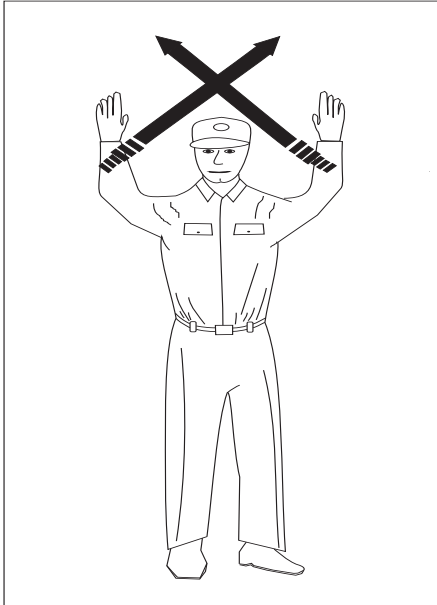

FIG 4-3-24
Stop



4-3-26. Operations at Uncontrolled Airports With Automated Surface Observing System (ASOS)/Automated Weather Observing System (AWOS)

a. Many airports throughout the National Airspace System are equipped with either ASOS or AWOS. At most airports with an operating control tower or human observer, the weather will be available to you in an Aviation Routine Weather Report (METAR) hourly or special observation format on the Automatic Terminal Information Service (ATIS) or directly transmitted from the controller/observer.

b. At uncontrolled airports that are equipped with ASOS/AWOS with ground-to-air broadcast capability, the one-minute updated airport weather should be available to you within approximately 25 NM of the airport below 10,000 feet. The frequency for the weather broadcast will be published on sectional charts and in the Chart Supplement U.S. Some part-time towered airports may also broadcast the automated weather on their ATIS frequency during the hours that the tower is closed.

c. Controllers issue SVFR or IFR clearances based on pilot request, known traffic and reported weather, i.e., METAR/Nonroutine (Special) Aviation Weather Report (SPECI) observations, when they are available. Pilots have access to more current weather at uncontrolled ASOS/AWOS airports than do the controllers who may be located several miles away. Controllers will rely on the pilot to determine the current airport weather from the ASOS/AWOS. All aircraft arriving or departing an ASOS/AWOS equipped uncontrolled airport should monitor the airport weather frequency to ascertain the status of the airspace. Pilots in Class E airspace must be alert for changing weather conditions which may affect the status of the airspace from IFR/VFR. If ATC service is required for IFR/SVFR approach/departure or requested for VFR service, the pilot should advise the controller that he/she has received the one-minute weather and state his/her intentions.

EXAMPLE-

"I have the (airport) one-minute weather, request an ILS Runway 14 approach."

REFERENCE-

AIM, Paragraph 7-1-12, Weather Observing Programs

Section 4. ATC Clearances and Aircraft Separation

4-4-1. Clearance

a. A clearance issued by ATC is predicated on known traffic and known physical airport conditions. An ATC clearance means an authorization by ATC, for the purpose of preventing collision between known aircraft, for an aircraft to proceed under specified conditions within controlled airspace. **IT IS NOT AUTHORIZATION FOR A PILOT TO DEVIATE FROM ANY RULE, REGULATION, OR MINIMUM ALTITUDE NOR TO CONDUCT UNSAFE OPERATION OF THE AIRCRAFT.**

b. 14 CFR Section 91.3(a) states: “The pilot-in-command of an aircraft is directly responsible for, and is the final authority as to, the operation of that aircraft.” If ATC issues a clearance that would cause a pilot to deviate from a rule or regulation, or in the pilot’s opinion, would place the aircraft in jeopardy, **IT IS THE PILOT’S RESPONSIBILITY TO REQUEST AN AMENDED CLEARANCE.** Similarly, if a pilot prefers to follow a different course of action, such as make a 360 degree turn for spacing to follow traffic when established in a landing or approach sequence, land on a different runway, takeoff from a different intersection, takeoff from the threshold instead of an intersection, or delay operation, **THE PILOT IS EXPECTED TO INFORM ATC ACCORDINGLY.** When the pilot requests a different course of action, however, the pilot is expected to cooperate so as to preclude disruption of traffic flow or creation of conflicting patterns. The pilot is also expected to use the appropriate aircraft call sign to acknowledge all ATC clearances, frequency changes, or advisory information.

c. Each pilot who deviates from an ATC clearance in response to a Traffic Alert and Collision Avoidance System resolution advisory must notify ATC of that deviation as soon as possible.

REFERENCE—
Pilot/Controller Glossary Term—Traffic Alert and Collision Avoidance System.

d. When weather conditions permit, during the time an IFR flight is operating, it is the direct responsibility of the pilot to avoid other aircraft since VFR flights may be operating in the same area without the knowledge of ATC. Traffic clearances

provide standard separation only between IFR flights.

4-4-2. Clearance Prefix

A clearance, control information, or a response to a request for information originated by an ATC facility and relayed to the pilot through an air-to-ground communication station will be prefixed by “ATC clears,” “ATC advises,” or “ATC requests.”

4-4-3. Clearance Items

ATC clearances normally contain the following:

a. Clearance Limit. The traffic clearance issued prior to departure will normally authorize flight to the airport of intended landing. Many airports and associated NAVAIDs are collocated with the same name and/or identifier, so care should be exercised to ensure a clear understanding of the clearance limit. When the clearance limit is the airport of intended landing, the clearance should contain the airport name followed by the word “airport.” Under certain conditions, a clearance limit may be a NAVAID or other fix. When the clearance limit is a NAVAID, intersection, or waypoint and the type is known, the clearance should contain type. Under certain conditions, at some locations a short-range clearance procedure is utilized whereby a clearance is issued to a fix within or just outside of the terminal area and pilots are advised of the frequency on which they will receive the long-range clearance direct from the center controller.

b. Departure Procedure. Headings to fly and altitude restrictions may be issued to separate a departure from other air traffic in the terminal area. Where the volume of traffic warrants, DPs have been developed.

REFERENCE—

AIM, Paragraph 5-2-5, Abbreviated IFR Departure Clearance (Cleared . . . as Filed) Procedures

AIM, Paragraph 5-2-9, Instrument Departure Procedures (DP) – Obstacle Departure Procedures (ODP) and Standard Instrument Departures (SID)

c. Route of Flight.

1. Clearances are normally issued for the altitude or flight level and route filed by the pilot. However, due to traffic conditions, it is frequently necessary for ATC to specify an altitude or flight level

or route different from that requested by the pilot. In addition, flow patterns have been established in certain congested areas or between congested areas whereby traffic capacity is increased by routing all traffic on preferred routes. Information on these flow patterns is available in offices where preflight briefing is furnished or where flight plans are accepted.

2. When required, air traffic clearances include data to assist pilots in identifying radio reporting points. It is the responsibility of pilots to notify ATC immediately if their radio equipment cannot receive the type of signals they must utilize to comply with their clearance.

d. Altitude Data.

1. The altitude or flight level instructions in an ATC clearance normally require that a pilot “MAINTAIN” the altitude or flight level at which the flight will operate when in controlled airspace. Altitude or flight level changes while en route should be requested prior to the time the change is desired.

2. When possible, if the altitude assigned is different from the altitude requested by the pilot, ATC will inform the pilot when to expect climb or descent clearance or to request altitude change from another facility. If this has not been received prior to crossing the boundary of the ATC facility’s area and assignment at a different altitude is still desired, the pilot should reinitiate the request with the next facility.

3. The term “cruise” may be used instead of “MAINTAIN” to assign a block of airspace to a pilot from the minimum IFR altitude up to and including the altitude specified in the cruise clearance. The pilot may level off at any intermediate altitude within this block of airspace. Climb/descent within the block is to be made at the discretion of the pilot. However, once the pilot starts descent and verbally reports leaving an altitude in the block, the pilot may not return to that altitude without additional ATC clearance.

REFERENCE–

Pilot/Controller Glossary Term– Cruise.

e. Holding Instructions.

1. Whenever an aircraft has been cleared to a fix other than the destination airport and delay is expected, it is the responsibility of the ATC controller to issue complete holding instructions (unless the

pattern is charted), an EFC time, and a best estimate of any additional en route/terminal delay.

2. If the holding pattern is charted and the controller doesn’t issue complete holding instructions, the pilot is expected to hold as depicted on the appropriate chart. When the pattern is charted, the controller may omit all holding instructions except the charted holding direction and the statement *AS PUBLISHED*, e.g., “*HOLD EAST AS PUBLISHED.*” Controllers must always issue complete holding instructions when pilots request them.

NOTE–

Only those holding patterns depicted on U.S. government or commercially produced charts which meet FAA requirements should be used.

3. If no holding pattern is charted and holding instructions have not been issued, the pilot should ask ATC for holding instructions prior to reaching the fix. This procedure will eliminate the possibility of an aircraft entering a holding pattern other than that desired by ATC. If unable to obtain holding instructions prior to reaching the fix (due to frequency congestion, stuck microphone, etc.), hold in a standard pattern on the course on which you approached the fix and request further clearance as soon as possible. In this event, the altitude/flight level of the aircraft at the clearance limit will be protected so that separation will be provided as required.

4. When an aircraft is 3 minutes or less from a clearance limit and a clearance beyond the fix has not been received, the pilot is expected to start a speed reduction so that the aircraft will cross the fix, initially, at or below the maximum holding airspeed.

5. When no delay is expected, the controller should issue a clearance beyond the fix as soon as possible and, whenever possible, at least 5 minutes before the aircraft reaches the clearance limit.

6. Pilots should report to ATC the time and altitude/flight level at which the aircraft reaches the clearance limit and report leaving the clearance limit.

NOTE–

In the event of two-way communications failure, pilots are required to comply with 14 CFR Section 91.185.

4-4-4. Amended Clearances

a. Amendments to the initial clearance will be issued at any time an air traffic controller deems such

action necessary to avoid possible confliction between aircraft. Clearances will require that a flight “hold” or change altitude prior to reaching the point where standard separation from other IFR traffic would no longer exist.

NOTE—

Some pilots have questioned this action and requested “traffic information” and were at a loss when the reply indicated “no traffic report.” In such cases the controller has taken action to prevent a traffic confliction which would have occurred at a distant point.

b. A pilot may wish an explanation of the handling of the flight at the time of occurrence; however, controllers are not able to take time from their immediate control duties nor can they afford to overload the ATC communications channels to furnish explanations. Pilots may obtain an explanation by directing a letter or telephone call to the chief controller of the facility involved.

c. Pilots have the privilege of requesting a different clearance from that which has been issued by ATC if they feel that they have information which would make another course of action more practicable or if aircraft equipment limitations or company procedures forbid compliance with the clearance issued.

4-4-5. Coded Departure Route (CDR)

a. CDRs provide air traffic control a rapid means to reroute departing aircraft when the filed route is constrained by either weather or congestion.

b. CDRs consist of an eight-character designator that represents a route of flight. The first three alphanumeric characters represent the departure airport, characters four through six represent the arrival airport, and the last two characters are chosen by the overlying ARTCC. For example, PITORDN1 is an alternate route from Pittsburgh to Chicago. Participating aircrews may then be re-cleared by air traffic control via the CDR abbreviated clearance, PITORDN1.

c. CDRs are updated on the 56 day charting cycle. Participating aircrews must ensure that their CDR is current.

d. Traditionally, CDRs have been used by air transport companies that have signed a Memorandum of Agreement with the local air traffic control facility. General aviation customers who wish to participate in

the program may now enter “CDR Capable” in the remarks section of their flight plan.

e. When “CDR Capable” is entered into the remarks section of the flight plan the general aviation customer communicates to ATC the ability to decode the current CDR into a flight plan route and the willingness to fly a different route than that which was filed.

4-4-6. Special VFR Clearances

a. An ATC clearance must be obtained *prior* to operating within a Class B, Class C, Class D, or Class E surface area when the weather is less than that required for VFR flight. A VFR pilot may request and be given a clearance to enter, leave, or operate within most Class D and Class E surface areas and some Class B and Class C surface areas in special VFR conditions, traffic permitting, and providing such flight will not delay IFR operations. All special VFR flights must remain clear of clouds. The visibility requirements for special VFR aircraft (other than helicopters) are:

1. At least 1 statute mile flight visibility for operations within Class B, Class C, Class D, and Class E surface areas.

2. At least 1 statute mile ground visibility if taking off or landing. If ground visibility is not reported at that airport, the flight visibility must be at least 1 statute mile.

3. The restrictions in subparagraphs 1 and 2 do not apply to helicopters. Helicopters must remain clear of clouds and may operate in Class B, Class C, Class D, and Class E surface areas with less than 1 statute mile visibility.

b. When a control tower is located within the Class B, Class C, or Class D surface area, requests for clearances should be to the tower. In a Class E surface area, a clearance may be obtained from the nearest tower, FSS, or center.

c. It is not necessary to file a complete flight plan with the request for clearance, but pilots should state their intentions in sufficient detail to permit ATC to fit their flight into the traffic flow. The clearance will not contain a specific altitude as the pilot must remain clear of clouds. The controller may require the pilot to fly at or below a certain altitude due to other traffic, but the altitude specified will permit flight at or above the minimum safe altitude. In addition, at radar

locations, flights may be vectored if necessary for control purposes or on pilot request.

NOTE—

The pilot is responsible for obstacle or terrain clearance.

REFERENCE—

14 CFR Section 91.119, Minimum safe altitudes: General.

d. Special VFR clearances are effective within Class B, Class C, Class D, and Class E surface areas only. ATC does not provide separation after an aircraft leaves the Class B, Class C, Class D, or Class E surface area on a special VFR clearance.

e. Special VFR operations by fixed-wing aircraft are prohibited in some Class B and Class C surface areas due to the volume of IFR traffic. A list of these Class B and Class C surface areas is contained in 14 CFR Part 91, Appendix D, Section 3. They are also depicted on sectional aeronautical charts.

f. ATC provides separation between Special VFR flights and between these flights and other IFR flights.

g. Special VFR operations by fixed-wing aircraft are prohibited between sunset and sunrise unless the pilot is instrument rated and the aircraft is equipped for IFR flight.

h. Pilots arriving or departing an uncontrolled airport that has automated weather broadcast capability (ASOS/AWOS) should monitor the broadcast frequency, advise the controller that they have the “one-minute weather” and state intentions prior to operating within the Class B, Class C, Class D, or Class E surface areas.

REFERENCE—

Pilot/Controller Glossary Term— One-minute Weather.

4-4-7. Pilot Responsibility upon Clearance Issuance

a. Record ATC clearance. When conducting an IFR operation, make a written record of your clearance. The specified conditions which are a part of your air traffic clearance may be somewhat different from those included in your flight plan. Additionally, ATC may find it necessary to ADD conditions, such as particular departure route. The very fact that ATC specifies different or additional conditions means that other aircraft are involved in the traffic situation.

b. ATC Clearance/Instruction Readback.

Pilots of airborne aircraft should read back *those parts* of ATC clearances and instructions containing altitude assignments, vectors, or runway assignments as a means of mutual verification. The read back of the “numbers” serves as a double check between pilots and controllers and reduces the kinds of communications errors that occur when a number is either “misheard” or is incorrect.

1. Include the aircraft identification in all readbacks and acknowledgments. This aids controllers in determining that the correct aircraft received the clearance or instruction. The requirement to include aircraft identification in all readbacks and acknowledgements becomes more important as frequency congestion increases and when aircraft with similar call signs are on the same frequency.

EXAMPLE—

“Climbing to Flight Level three three zero, United Twelve” or “November Five Charlie Tango, roger, cleared to land runway nine left.”

2. Read back altitudes, altitude restrictions, and vectors in the same sequence as they are given in the clearance or instruction.

3. Altitudes contained in charted procedures, such as DPs, instrument approaches, etc., should not be read back unless they are specifically stated by the controller.

4. Initial read back of a taxi, departure or landing clearance should include the runway assignment, including left, right, center, etc. if applicable.

c. It is the responsibility of the pilot to accept or refuse the clearance issued.

4-4-8. IFR Clearance VFR-on-top

a. A pilot on an IFR flight plan operating in VFR weather conditions, may request VFR-on-top in lieu of an assigned altitude. This permits a pilot to select an altitude or flight level of their choice (subject to any ATC restrictions.)

b. Pilots desiring to climb through a cloud, haze, smoke, or other meteorological formation and then either cancel their IFR flight plan or operate VFR-on-top may request a climb to VFR-on-top. The ATC authorization must contain either a top report or a statement that no top report is available, and a request to report reaching VFR-on-top. Additionally, the ATC authorization may contain a clearance limit,

routing and an alternative clearance if VFR-on-top is not reached by a specified altitude.

c. A pilot on an IFR flight plan, operating in VFR conditions, may request to climb/descend in VFR conditions.

d. ATC may not authorize VFR-on-top/VFR conditions operations unless the pilot requests the VFR operation or a clearance to operate in VFR conditions will result in noise abatement benefits where part of the IFR departure route does not conform to an FAA approved noise abatement route or altitude.

e. When operating in VFR conditions with an ATC authorization to “maintain VFR-on-top/maintain VFR conditions” pilots on IFR flight plans must:

1. Fly at the appropriate VFR altitude as prescribed in 14 CFR Section 91.159.

2. Comply with the VFR visibility and distance from cloud criteria in 14 CFR Section 91.155 (Basic VFR Weather Minimums).

3. Comply with instrument flight rules that are applicable to this flight; i.e., minimum IFR altitudes, position reporting, radio communications, course to be flown, adherence to ATC clearance, etc.

NOTE–

Pilots should advise ATC prior to any altitude change to ensure the exchange of accurate traffic information.

f. ATC authorization to “maintain VFR-on-top” is not intended to restrict pilots so that they must operate only *above* an obscuring meteorological formation (layer). Instead, it permits operation above, below, between layers, or in areas where there is no meteorological obscuration. It is imperative, however, that pilots understand that clearance to operate “VFR-on-top/VFR conditions” does not imply cancellation of the IFR flight plan.

g. Pilots operating VFR-on-top/VFR conditions may receive traffic information from ATC on other pertinent IFR or VFR aircraft. However, aircraft operating in Class B airspace/TRSAs must be separated as required by FAA Order JO 7110.65, Air Traffic Control.

NOTE–

When operating in VFR weather conditions, it is the pilot’s responsibility to be vigilant so as to see-and-avoid other aircraft.

h. ATC will not authorize VFR or VFR-on-top operations in Class A airspace.

REFERENCE–

AIM, Paragraph 3–2–2, Class A Airspace

4–4–9. VFR/IFR Flights

A pilot departing VFR, either intending to or needing to obtain an IFR clearance en route, must be aware of the position of the aircraft and the relative terrain/obstructions. When accepting a clearance below the MEA/MIA/MVA/OROCA, pilots are responsible for their own terrain/obstruction clearance until reaching the MEA/MIA/MVA/OROCA. If pilots are unable to maintain terrain/obstruction clearance, the controller should be advised and pilots should state their intentions.

NOTE–

OROCA is an off-route altitude which provides obstruction clearance with a 1,000 foot buffer in nonmountainous terrain areas and a 2,000 foot buffer in designated mountainous areas within the U.S. This altitude may not provide signal coverage from ground-based navigational aids, air traffic control radar, or communications coverage.

4–4–10. Adherence to Clearance

a. When air traffic clearance has been obtained under either visual or instrument flight rules, the pilot-in-command of the aircraft must not deviate from the provisions thereof unless an amended clearance is obtained. When ATC issues a clearance or instruction, pilots are expected to execute its provisions upon receipt. ATC, in certain situations, will include the word “IMMEDIATELY” in a clearance or instruction to impress urgency of an imminent situation and expeditious compliance by the pilot is expected and necessary for safety. The addition of a VFR or other restriction; i.e., climb or descent point or time, crossing altitude, etc., does not authorize a pilot to deviate from the route of flight or any other provision of the ATC clearance.

b. When a heading is assigned or a turn is requested by ATC, pilots are expected to promptly initiate the turn, to complete the turn, and maintain the new heading unless issued additional instructions.

c. The term “AT PILOT’S DISCRETION” included in the altitude information of an ATC clearance means that ATC has offered the pilot the option to start climb or descent when the pilot wishes,

is authorized to conduct the climb or descent at any rate, and to temporarily level off at any intermediate altitude as desired. However, once the aircraft has vacated an altitude, it may not return to that altitude.

d. When ATC has not used the term “AT PILOT’S DISCRETION” nor imposed any climb or descent restrictions, pilots should initiate climb or descent promptly on acknowledgement of the clearance. Descend or climb at an optimum rate consistent with the operating characteristics of the aircraft to 1,000 feet above or below the assigned altitude, and then attempt to descend or climb at a rate of between 500 and 1,500 fpm until the assigned altitude is reached. If at anytime the pilot is unable to climb or descend at a rate of at least 500 feet a minute, advise ATC. If it is necessary to level off at an intermediate altitude during climb or descent, advise ATC, except when leveling off at 10,000 feet MSL on descent, or 2,500 feet above airport elevation (prior to entering a Class C or Class D surface area), when required for speed reduction.

REFERENCE–
14 CFR Section 91.117.

NOTE–
Leveling off at 10,000 feet MSL on descent or 2,500 feet above airport elevation (prior to entering a Class C or Class D surface area) to comply with 14 CFR Section 91.117 airspeed restrictions is commonplace. Controllers anticipate this action and plan accordingly. Leveling off at any other time on climb or descent may seriously affect air traffic handling by ATC. Consequently, it is imperative that pilots make every effort to fulfill the above expected actions to aid ATC in safely handling and expediting traffic.

e. If the altitude information of an ATC DESCENT clearance includes a provision to “CROSS (fix) AT” or “AT OR ABOVE/BELOW (altitude),” the manner in which the descent is executed to comply with the crossing altitude is at the pilot’s discretion. This authorization to descend at pilot’s discretion is only applicable to that portion of the flight to which the crossing altitude restriction applies, and the pilot is expected to comply with the crossing altitude as a provision of the clearance. Any other clearance in which pilot execution is optional will so state “AT PILOT’S DISCRETION.”

EXAMPLE–
1. “United Four Seventeen, descend and maintain six thousand.”

NOTE–
1. *The pilot is expected to commence descent upon receipt of the clearance and to descend at the suggested rates until reaching the assigned altitude of 6,000 feet.*

EXAMPLE–
2. “United Four Seventeen, descend at pilot’s discretion, maintain six thousand.”

NOTE–
2. *The pilot is authorized to conduct descent within the context of the term at pilot’s discretion as described above.*

EXAMPLE–
3. “United Four Seventeen, cross Lakeview V–O–R at or above Flight Level two zero zero, descend and maintain six thousand.”

NOTE–
3. *The pilot is authorized to conduct descent at pilot’s discretion until reaching Lakeview VOR and must comply with the clearance provision to cross the Lakeview VOR at or above FL 200. After passing Lakeview VOR, the pilot is expected to descend at the suggested rates until reaching the assigned altitude of 6,000 feet.*

EXAMPLE–
4. “United Four Seventeen, cross Lakeview V–O–R at six thousand, maintain six thousand.”

NOTE–
4. *The pilot is authorized to conduct descent at pilot’s discretion, however, must comply with the clearance provision to cross the Lakeview VOR at 6,000 feet.*

EXAMPLE–
5. “United Four Seventeen, descend now to Flight Level two seven zero, cross Lakeview V–O–R at or below one zero thousand, descend and maintain six thousand.”

NOTE–
5. *The pilot is expected to promptly execute and complete descent to FL 270 upon receipt of the clearance. After reaching FL 270 the pilot is authorized to descend “at pilot’s discretion” until reaching Lakeview VOR. The pilot must comply with the clearance provision to cross Lakeview VOR at or below 10,000 feet. After Lakeview VOR the pilot is expected to descend at the suggested rates until reaching 6,000 feet.*

EXAMPLE–
6. “United Three Ten, descend now and maintain Flight Level two four zero, pilot’s discretion after reaching Flight Level two eight zero.”

NOTE–
6. *The pilot is expected to commence descent upon receipt of the clearance and to descend at the suggested rates until reaching FL 280. At that point, the pilot is authorized to continue descent to FL 240 within the context of the term “at pilot’s discretion” as described above.*

f. In case emergency authority is used to deviate from provisions of an ATC clearance, the pilot-in-

command must notify ATC as soon as possible and obtain an amended clearance. In an emergency situation which does not result in a deviation from the rules prescribed in 14 CFR Part 91 but which requires ATC to give priority to an aircraft, the pilot of such aircraft must, when requested by ATC, make a report within 48 hours of such emergency situation to the manager of that ATC facility.

g. The guiding principle is that the last ATC clearance has precedence over the previous ATC clearance. When the route or altitude in a previously issued clearance is amended, the controller will restate applicable altitude restrictions. If altitude to maintain is changed or restated, whether prior to departure or while airborne, and previously issued altitude restrictions are omitted, those altitude restrictions are canceled, including departure procedures and STAR altitude restrictions.

EXAMPLE–

1. *A departure flight receives a clearance to destination airport to maintain FL 290. The clearance incorporates a DP which has certain altitude crossing restrictions. Shortly after takeoff, the flight receives a new clearance changing the maintaining FL from 290 to 250. If the altitude restrictions are still applicable, the controller restates them.*

2. *A departing aircraft is cleared to cross Fluky Intersection at or above 3,000 feet, Gordonville VOR at or above 12,000 feet, maintain FL 200. Shortly after departure, the altitude to be maintained is changed to FL 240. If the altitude restrictions are still applicable, the controller issues an amended clearance as follows: “cross Fluky Intersection at or above three thousand, cross Gordonville V–O–R at or above one two thousand, maintain Flight Level two four zero.”*

3. *An arriving aircraft is cleared to the destination airport via V45 Delta VOR direct; the aircraft is cleared to cross Delta VOR at 10,000 feet, and then to maintain 6,000 feet. Prior to Delta VOR, the controller issues an amended clearance as follows: “turn right heading one eight zero for vector to runway three six I–L–S approach, maintain six thousand.”*

NOTE–

Because the altitude restriction “cross Delta V–O–R at 10,000 feet” was omitted from the amended clearance, it is no longer in effect.

h. Pilots of turbojet aircraft equipped with afterburner engines should advise ATC prior to takeoff if they intend to use afterburning during their climb to the en route altitude. Often, the controller

may be able to plan traffic to accommodate a high performance climb and allow the aircraft to climb to the planned altitude without restriction.

i. If an “expedite” climb or descent clearance is issued by ATC, and the altitude to maintain is subsequently changed or restated without an expedite instruction, the expedite instruction is canceled. Expedite climb/descent normally indicates to the pilot that the approximate best rate of climb/descent should be used without requiring an exceptional change in aircraft handling characteristics. Normally controllers will inform pilots of the reason for an instruction to expedite.

4–4–11. IFR Separation Standards

a. ATC effects separation of aircraft vertically by assigning different altitudes; longitudinally by providing an interval expressed in time or distance between aircraft on the same, converging, or crossing courses, and laterally by assigning different flight paths.

b. Separation will be provided between all aircraft operating on IFR flight plans except during that part of the flight (outside Class B airspace or a TRSA) being conducted on a VFR–on–top/VFR conditions clearance. Under these conditions, ATC may issue traffic advisories, but it is the sole responsibility of the pilot to be vigilant so as to see and avoid other aircraft.

c. When radar is employed in the separation of aircraft at the same altitude, a minimum of 3 miles separation is provided between aircraft operating within 40 miles of the radar antenna site, and 5 miles between aircraft operating beyond 40 miles from the antenna site. These minima may be increased or decreased in certain specific situations.

NOTE–

Certain separation standards are increased in the terminal environment when CENRAP is being utilized.

4–4–12. Speed Adjustments

a. ATC will issue speed adjustments to pilots of radar–controlled aircraft to achieve or maintain required or desired spacing.

b. ATC will express all speed adjustments in terms of knots based on indicated airspeed (IAS) in 5 or 10 knot increments except that at or above FL 240 speeds may be expressed in terms of Mach numbers in 0.01 increments. The use of Mach

numbers is restricted to turbojet aircraft with Mach meters.

c. Pilots complying with speed adjustments are expected to maintain a speed within plus or minus 10 knots or 0.02 Mach number of the specified speed.

d. When ATC assigns speed adjustments, it will be in accordance with the following recommended minimums:

1. To aircraft operating between FL 280 and 10,000 feet, a speed not less than 250 knots or the equivalent Mach number.

NOTE-

1. On a standard day the Mach numbers equivalent to 250 knots CAS (subject to minor variations) are:

FL 240–0.6

FL 250–0.61

FL 260–0.62

FL 270–0.64

FL 280–0.65

FL 290–0.66.

2. When an operational advantage will be realized, speeds lower than the recommended minima may be applied.

2. To arriving turbojet aircraft operating below 10,000 feet:

(a) A speed not less than 210 knots, except;

(b) Within 20 flying miles of the airport of intended landing, a speed not less than 170 knots.

3. To arriving reciprocating engine or turboprop aircraft within 20 flying miles of the runway threshold of the airport of intended landing, a speed not less than 150 knots.

4. To departing aircraft:

(a) Turbojet aircraft, a speed not less than 230 knots.

(b) Reciprocating engine aircraft, a speed not less than 150 knots.

e. When ATC combines a speed adjustment with a descent clearance, the sequence of delivery, with the word “then” between, indicates the expected order of execution.

EXAMPLE-

1. Descend and maintain (altitude); then, reduce speed to (speed).

2. Reduce speed to (speed); then, descend and maintain (altitude).

NOTE-

The maximum speeds below 10,000 feet as established in 14 CFR Section 91.117 still apply. If there is any doubt concerning the manner in which such a clearance is to be executed, request clarification from ATC.

f. If ATC determines (before an approach clearance is issued) that it is no longer necessary to apply speed adjustment procedures, they will:

1. Advise the pilot to “resume normal speed.”

Normal speed is used to terminate ATC assigned speed adjustments on segments where no published speed restrictions apply. It does not cancel published restrictions on upcoming procedures. This does not relieve the pilot of those speed restrictions which are applicable to 14 CFR Section 91.117.

EXAMPLE-

(An aircraft is flying a SID with no published speed restrictions. ATC issues a speed adjustment and instructs the aircraft where the adjustment ends): “Maintain two two zero knots until BALTR then resume normal speed.”

NOTE-

The ATC assigned speed assignment of two two zero knots would apply until BALTR. The aircraft would then resume a normal operating speed while remaining in compliance with 14 CFR Section 91.117.

2. Instruct pilots to “comply with speed restrictions” when the aircraft is joining or resuming a charted procedure or route with published speed restrictions.

EXAMPLE-

(ATC vectors an aircraft off of a SID to rejoin the procedure at a subsequent waypoint. When instructing the aircraft to resume the procedure, ATC also wants the aircraft to comply with the published procedure speed restrictions): “Resume the SALTY ONE departure. Comply with speed restrictions.”

CAUTION-

The phraseology “Descend via/Climb via SID” requires compliance with all altitude and/or speed restrictions depicted on the procedure.

3. Instruct the pilot to “resume published speed.” Resume published speed is issued to terminate a speed adjustment where speed restrictions are published on a charted procedure.

NOTE-

When instructed to “comply with speed restrictions” or to “resume published speed,” ATC anticipates pilots will begin adjusting speed the minimum distance necessary prior to a published speed restriction so as to cross the waypoint/fix at the published speed. Once at the published

speed, ATC expects pilots will maintain the published speed until additional adjustment is required to comply with further published or ATC assigned speed restrictions or as required to ensure compliance with 14 CFR Section 91.117.

EXAMPLE–

(An aircraft is flying a SID/STAR with published speed restrictions. ATC issues a speed adjustment and instructs the aircraft where the adjustment ends): “Maintain two two zero knots until BALTR then resume published speed.”

NOTE–

The ATC assigned speed assignment of two two zero knots would apply until BALTR. The aircraft would then comply with the published speed restrictions.

4. Advise the pilot to “delete speed restrictions” when either ATC assigned or published speed restrictions on a charted procedure are no longer required.

EXAMPLE–

(An aircraft is flying a SID with published speed restrictions designed to prevent aircraft overtake on departure. ATC determines there is no conflicting traffic and deletes the speed restriction): “Delete speed restrictions.”

NOTE–

When deleting published restrictions, ATC must ensure obstacle clearance until aircraft are established on a route where no published restrictions apply. This does not relieve the pilot of those speed restrictions which are applicable to 14 CFR Section 91.117.

5. Instruct the pilot to “climb via” or “descend via.” A climb via or descend via clearance cancels any previously issued speed restrictions and, once established on the depicted departure or arrival, to climb or descend, and to meet all published or assigned altitude and/or speed restrictions.

EXAMPLE–

1. (An aircraft is flying a SID with published speed restrictions. ATC has issued a speed restriction of 250 knots for spacing. ATC determines that spacing between aircraft is adequate and desires the aircraft to comply with published restrictions): “United 436, Climb via SID.”

2. (An aircraft is established on a STAR. ATC must slow an aircraft for the purposes of spacing and assigns it a speed of 280 knots. When spacing is adequate, ATC deletes the speed restriction and desires that the aircraft comply with all published restrictions on the STAR): “Gulfstream two three papa echo, descend via the TYLER One arrival.”

NOTE–

1. In example 1, when ATC issues a “Climb via SID” clearance, it deletes any previously issued speed and/or

altitude restrictions. The pilot should then vertically navigate to comply with all speed and/or altitude restrictions published on the SID.

2. In example 2, when ATC issues a “Descend via <STAR name> arrival,” ATC has canceled any previously issued speed and/or altitude restrictions. The pilot should vertically navigate to comply with all speed and/or altitude restrictions published on the STAR.

CAUTION–

When descending on a STAR, pilots should not speed up excessively beyond the previously issued speed. Otherwise, adequate spacing between aircraft descending on the STAR that was established by ATC with the previous restriction may be lost.

g. Approach clearances supersede any prior speed adjustment assignments, and pilots are expected to make their own speed adjustments as necessary to complete the approach. However, under certain circumstances, it may be necessary for ATC to issue further speed adjustments after approach clearance is issued to maintain separation between successive arrivals. Under such circumstances, previously issued speed adjustments will be restated if that speed is to be maintained or additional speed adjustments are requested. Speed adjustments should not be assigned inside the final approach fix on final or a point 5 miles from the runway, whichever is closer to the runway.

h. The pilots retain the prerogative of rejecting the application of speed adjustment by ATC if the minimum safe airspeed for any particular operation is greater than the speed adjustment.

NOTE–

In such cases, pilots are expected to advise ATC of the speed that will be used.

i. Pilots are reminded that they are responsible for rejecting the application of speed adjustment by ATC if, in their opinion, it will cause them to exceed the maximum indicated airspeed prescribed by 14 CFR Section 91.117(a), (c) and (d). **IN SUCH CASES, THE PILOT IS EXPECTED TO SO INFORM ATC.** Pilots operating at or above 10,000 feet MSL who are issued speed adjustments which exceed 250 knots IAS and are subsequently cleared below 10,000 feet MSL are expected to comply with 14 CFR Section 91.117(a).

j. Speed restrictions of 250 knots do not apply to U.S. registered aircraft operating beyond 12 nautical miles from the coastline within the U.S. Flight

Information Region, in Class E airspace below 10,000 feet MSL. However, in airspace underlying a Class B airspace area designated for an airport, or in a VFR corridor designated through such as a Class B airspace area, pilots are expected to comply with the 200 knot speed limit specified in 14 CFR Section 91.117(c).

k. For operations in a Class C and Class D surface area, ATC is authorized to request or approve a speed greater than the maximum indicated airspeeds prescribed for operation within that airspace (14 CFR Section 91.117(b)).

NOTE-

Pilots are expected to comply with the maximum speed of 200 knots when operating beneath Class B airspace or in a Class B VFR corridor (14 CFR Section 91.117(c) and (d)).

l. When in communications with the ARTCC or approach control facility, pilots should, as a good operating practice, state any ATC assigned speed restriction on initial radio contact associated with an ATC communications frequency change.

4-4-13. Runway Separation

Tower controllers establish the sequence of arriving and departing aircraft by requiring them to adjust flight or ground operation as necessary to achieve proper spacing. They may “HOLD” an aircraft short of the runway to achieve spacing between it and an arriving aircraft; the controller may instruct a pilot to “EXTEND DOWNWIND” in order to establish spacing from an arriving or departing aircraft. At times a clearance may include the word “IMMEDIATE.” For example: “CLEARED FOR IMMEDIATE TAKEOFF.” In such cases “IMMEDIATE” is used for purposes of *air traffic separation*. It is up to the pilot to refuse the clearance if, in the pilot’s opinion, compliance would adversely affect the operation.

REFERENCE-

AIM, Paragraph 4-3-15, Gate Holding due to Departure Delays

4-4-14. Visual Separation

a. Visual separation is a means employed by ATC to separate aircraft in terminal areas and en route airspace in the NAS. There are two methods employed to effect this separation:

1. The tower controller sees the aircraft involved and issues instructions, as necessary, to ensure that the aircraft avoid each other.

2. A pilot sees the other aircraft involved and upon instructions from the controller provides separation by maneuvering the aircraft to avoid it. When pilots accept responsibility to maintain visual separation, they must maintain constant visual surveillance and not pass the other aircraft until it is no longer a factor.

NOTE-

Traffic is no longer a factor when during approach phase the other aircraft is in the landing phase of flight or executes a missed approach; and during departure or en route, when the other aircraft turns away or is on a diverging course.

b. A pilot’s acceptance of instructions to follow another aircraft or provide visual separation from it is an acknowledgment that the pilot will maneuver the aircraft as necessary to avoid the other aircraft or to maintain in-trail separation. In operations conducted behind heavy aircraft, or a small aircraft behind a B757 or other large aircraft, it is also an acknowledgment that the pilot accepts the responsibility for wake turbulence separation. Visual separation is prohibited behind super aircraft.

NOTE-

When a pilot has been told to follow another aircraft or to provide visual separation from it, the pilot should promptly notify the controller if visual contact with the other aircraft is lost or cannot be maintained or if the pilot cannot accept the responsibility for the separation for any reason.

c. Scanning the sky for other aircraft is a key factor in collision avoidance. Pilots and copilots (or the right seat passenger) should continuously scan to cover all areas of the sky visible from the cockpit. Pilots must develop an effective scanning technique which maximizes one’s visual capabilities. Spotting a potential collision threat increases directly as more time is spent looking outside the aircraft. One must use timesharing techniques to effectively scan the surrounding airspace while monitoring instruments as well.

d. Since the eye can focus only on a narrow viewing area, effective scanning is accomplished with a series of short, regularly spaced eye movements that bring successive areas of the sky into the central visual field. Each movement should not exceed ten degrees, and each area should be observed for at least one second to enable collision detection.

Although many pilots seem to prefer the method of horizontal back-and-forth scanning every pilot should develop a scanning pattern that is not only comfortable but assures optimum effectiveness. Pilots should remember, however, that they have a regulatory responsibility (14 CFR Section 91.113(a)) to see and avoid other aircraft when weather conditions permit.

4-4-15. Use of Visual Clearing Procedures

a. Before Takeoff. Prior to taxiing onto a runway or landing area in preparation for takeoff, pilots should scan the approach areas for possible landing traffic and execute the appropriate clearing maneuvers to provide them a clear view of the approach areas.

b. Climbs and Descents. During climbs and descents in flight conditions which permit visual detection of other traffic, pilots should execute gentle banks, left and right at a frequency which permits continuous visual scanning of the airspace about them.

c. Straight and Level. Sustained periods of straight and level flight in conditions which permit visual detection of other traffic should be broken at intervals with appropriate clearing procedures to provide effective visual scanning.

d. Traffic Pattern. Entries into traffic patterns while descending create specific collision hazards and should be avoided.

e. Traffic at VOR Sites. All operators should emphasize the need for sustained vigilance in the vicinity of VORs and airway intersections due to the convergence of traffic.

f. Training Operations. Operators of pilot training programs are urged to adopt the following practices:

1. Pilots undergoing flight instruction at all levels should be requested to verbalize clearing procedures (call out “clear” left, right, above, or below) to instill and sustain the habit of vigilance during maneuvering.

2. **High-wing airplane.** Momentarily raise the wing in the direction of the intended turn and look.

3. **Low-wing airplane.** Momentarily lower the wing in the direction of the intended turn and look.

4. Appropriate clearing procedures should precede the execution of all turns including chandelles, lazy eights, stalls, slow flight, climbs, straight and level, spins, and other combination maneuvers.

4-4-16. Traffic Alert and Collision Avoidance System (TCAS I & II)

a. TCAS I provides proximity warning only, to assist the pilot in the visual acquisition of intruder aircraft. No recommended avoidance maneuvers are provided nor authorized as a direct result of a TCAS I warning. It is intended for use by smaller commuter aircraft holding 10 to 30 passenger seats, and general aviation aircraft.

b. TCAS II provides traffic advisories (TA) and resolution advisories (RA). Resolution advisories provide recommended maneuvers in a vertical direction (climb or descend only) to avoid conflicting traffic. Transport category aircraft, and larger commuter and business aircraft holding 31 passenger seats or more, are required to be TCAS II equipped.

1. When a TA occurs, attempt to establish visual contact with the traffic but do not deviate from an assigned clearance based only on TA information.

2. When an RA occurs, pilots should respond immediately to the RA displays and maneuver as indicated unless doing so would jeopardize the safe operation of the flight, or the flight crew can ensure separation with the help of definitive visual acquisition of the aircraft causing the RA.

3. Each pilot who deviates from an ATC clearance in response to an RA must notify ATC of that deviation as soon as practicable, and notify ATC when clear of conflict and returning to their previously assigned clearance.

c. Deviations from rules, policies, or clearances should be kept to the minimum necessary to satisfy an RA. Most RA maneuvering requires minimum excursion from assigned altitude.

d. The serving IFR air traffic facility is not responsible to provide approved standard IFR separation to an IFR aircraft, from other aircraft, terrain, or obstructions after an RA maneuver until one of the following conditions exists:

1. The aircraft has returned to its assigned altitude and course.

2. Alternate ATC instructions have been issued.

3. A crew member informs ATC that the TCAS maneuver has been completed.

NOTE—

TCAS does not alter or diminish the pilot's basic authority and responsibility to ensure safe flight. Since TCAS does not respond to aircraft which are not transponder equipped or aircraft with a transponder failure, TCAS alone does not ensure safe separation in every case. At this time, no air traffic service nor handling is predicated on the availability of TCAS equipment in the aircraft.

4-4-17. Traffic Information Service (TIS)

a. TIS provides proximity warning only, to assist the pilot in the visual acquisition of intruder aircraft. No recommended avoidance maneuvers are provided nor authorized as a direct result of a TIS intruder

display or TIS alert. It is intended for use by aircraft in which TCAS is not required.

b. TIS does not alter or diminish the pilot's basic authority and responsibility to ensure safe flight. Since TIS does not respond to aircraft which are not transponder equipped, aircraft with a transponder failure, or aircraft out of radar coverage, TIS alone does not ensure safe separation in every case.

c. At this time, no air traffic service nor handling is predicated on the availability of TIS equipment in the aircraft.

d. Presently, no air traffic services or handling is predicated on the availability of an ADS-B cockpit display. A "traffic-in-sight" reply to ATC must be based on seeing an aircraft out-the-window, NOT on the cockpit display.

Section 5. Surveillance Systems

4-5-1. Radar

a. Capabilities

1. Radar is a method whereby radio waves are transmitted into the air and are then received when they have been reflected by an object in the path of the beam. Range is determined by measuring the time it takes (at the speed of light) for the radio wave to go out to the object and then return to the receiving antenna. The direction of a detected object from a radar site is determined by the position of the rotating antenna when the reflected portion of the radio wave is received.

2. More reliable maintenance and improved equipment have reduced radar system failures to a negligible factor. Most facilities actually have some components duplicated, one operating and another which immediately takes over when a malfunction occurs to the primary component.

b. Limitations

1. It is very important for the aviation community to recognize the fact that there are limitations to radar service and that ATC controllers may not always be able to issue traffic advisories concerning aircraft which are not under ATC control and cannot be seen on radar. (See FIG 4-5-1.)

FIG 4-5-1
Limitations to Radar Service

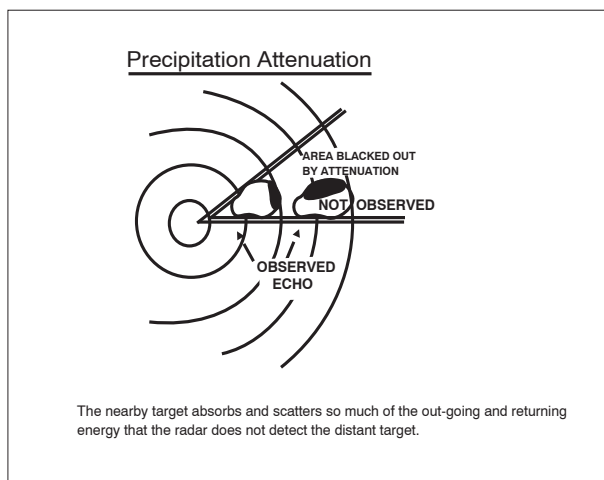

(a) The characteristics of radio waves are such that they normally travel in a continuous straight line unless they are:

(1) “Bent” by abnormal atmospheric phenomena such as temperature inversions;

(2) Reflected or attenuated by dense objects such as heavy clouds, precipitation, ground obstacles, mountains, etc.; or

(3) Screened by high terrain features.

(b) The bending of radar pulses, often called anomalous propagation or ducting, may cause many extraneous blips to appear on the radar operator’s display if the beam has been bent toward the ground or may decrease the detection range if the wave is bent upward. It is difficult to solve the effects of anomalous propagation, but using beacon radar and electronically eliminating stationary and slow moving targets by a method called moving target indicator (MTI) usually negate the problem.

(c) Radar energy that strikes dense objects will be reflected and displayed on the operator’s scope thereby blocking out aircraft at the same range and greatly weakening or completely eliminating the display of targets at a greater range. Again, radar beacon and MTI are very effectively used to combat ground clutter and weather phenomena, and a method of circularly polarizing the radar beam will eliminate some weather returns. A negative characteristic of MTI is that an aircraft flying a speed that coincides with the canceling signal of the MTI (tangential or “blind” speed) may not be displayed to the radar controller.

(d) Relatively low altitude aircraft will not be seen if they are screened by mountains or are below the radar beam due to earth curvature. The only solution to screening is the installation of strategically placed multiple radars which has been done in some areas.

(e) There are several other factors which affect radar control. The amount of reflective surface of an aircraft will determine the size of the radar return. Therefore, a small light airplane or a sleek jet fighter will be more difficult to see on radar than a large commercial jet or military bomber. Here again, the use of radar beacon is invaluable if the aircraft is

equipped with an airborne transponder. All ARTCCs' radars in the conterminous U.S. and many airport surveillance radars have the capability to interrogate Mode C and display altitude information to the controller from appropriately equipped aircraft. However, there are a number of airport surveillance radars that don't have Mode C display capability and; therefore, altitude information must be obtained from the pilot.

(f) At some locations within the ATC en route environment, secondary-radar-only (no primary radar) gap filler radar systems are used to give lower altitude radar coverage between two larger radar systems, each of which provides both primary and secondary radar coverage. In those geographical areas served by secondary-radar only, aircraft without transponders cannot be provided with radar service. Additionally, transponder equipped aircraft cannot be provided with radar advisories concerning primary targets and weather.

REFERENCE-
Pilot/Controller Glossary Term- Radar.

(g) The controller's ability to advise a pilot flying on instruments or in visual conditions of the aircraft's proximity to another aircraft will be limited if the unknown aircraft is not observed on radar, if no flight plan information is available, or if the volume of traffic and workload prevent issuing traffic information. The controller's first priority is given to establishing vertical, lateral, or longitudinal separation between aircraft flying IFR under the control of ATC.

c. FAA radar units operate continuously at the locations shown in the Chart Supplement U.S., and their services are available to all pilots, both civil and military. Contact the associated FAA control tower or ARTCC on any frequency guarded for initial instructions, or in an emergency, any FAA facility for information on the nearest radar service.

4-5-2. Air Traffic Control Radar Beacon System (ATCRBS)

a. The ATCRBS, sometimes referred to as secondary surveillance radar, consists of three main components:

1. Interrogator. Primary radar relies on a signal being transmitted from the radar antenna site and for this signal to be reflected or "bounced back"

from an object (such as an aircraft). This reflected signal is then displayed as a "target" on the controller's radarscope. In the ATCRBS, the Interrogator, a ground based radar beacon transmitter-receiver, scans in synchronism with the primary radar and transmits discrete radio signals which repetitiously request all transponders, on the mode being used, to reply. The replies received are then mixed with the primary returns and both are displayed on the same radarscope.

2. Transponder. This airborne radar beacon transmitter-receiver automatically receives the signals from the interrogator and selectively replies with a specific pulse group (code) only to those interrogations being received on the mode to which it is set. These replies are independent of, and much stronger than a primary radar return.

3. Radarscope. The radarscope used by the controller displays returns from both the primary radar system and the ATCRBS. These returns, called targets, are what the controller refers to in the control and separation of traffic.

b. The job of identifying and maintaining identification of primary radar targets is a long and tedious task for the controller. Some of the advantages of ATCRBS over primary radar are:

1. Reinforcement of radar targets.
2. Rapid target identification.
3. Unique display of selected codes.

c. A part of the ATCRBS ground equipment is the decoder. This equipment enables a controller to assign discrete transponder codes to each aircraft under his/her control. Normally only one code will be assigned for the entire flight. Assignments are made by the ARTCC computer on the basis of the National Beacon Code Allocation Plan. The equipment is also designed to receive Mode C altitude information from the aircraft.

NOTE-

Refer to figures with explanatory legends for an illustration of the target symbology depicted on radar scopes in the NAS Stage A (en route), the ARTS III (terminal) Systems, and other nonautomated (broadband) radar systems. (See FIG 4-5-2 and FIG 4-5-3.)

d. It should be emphasized that aircraft transponders greatly improve the effectiveness of radar systems.

REFERENCE-
AIM, Paragraph 4-1-20, Transponder Operation

FIG 4-5-2
ARTS III Radar Scope With Alphanumeric Data

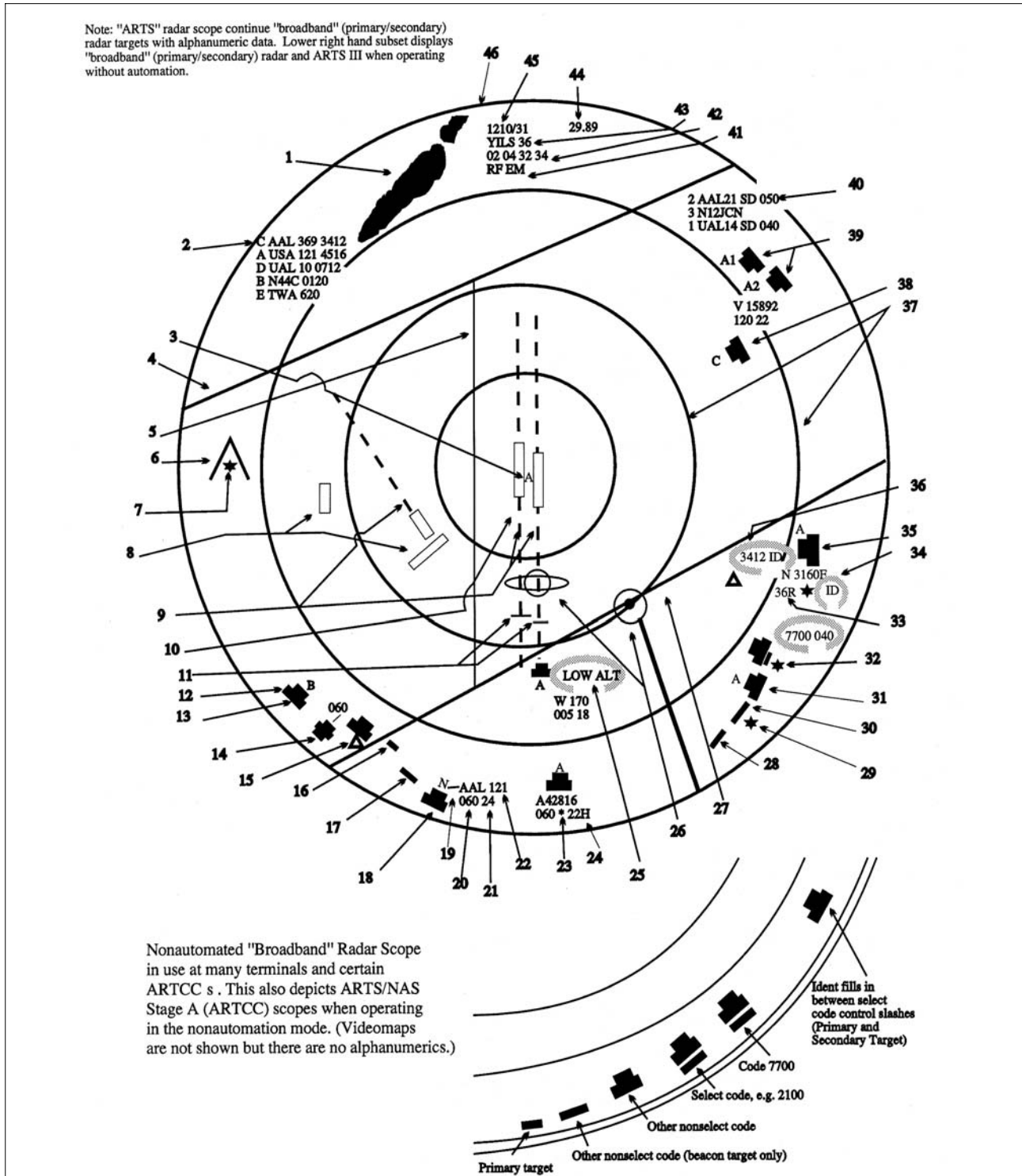

NOTE-

A number of radar terminals do not have ARTS equipment. Those facilities and certain ARTCCs outside the contiguous U.S. would have radar displays similar to the lower right hand subset. ARTS facilities and NAS Stage A ARTCCs, when operating in the nonautomation mode, would also have similar displays and certain services based on automation may not be available.

EXAMPLE-

1. Areas of precipitation (can be reduced by CP)
2. Arrival/departure tabular list
3. Trackball (control) position symbol (A)
4. Airway (lines are sometimes deleted in part)
5. Radar limit line for control
6. Obstruction (video map)
7. Primary radar returns of obstacles or terrain (can be removed by MTI)
8. Satellite airports
9. Runway centerlines (marks and spaces indicate miles)
10. Primary airport with parallel runways
11. Approach gates
12. Tracked target (primary and beacon target)
13. Control position symbol
14. Untracked target select code (monitored) with Mode C readout of 5,000'
15. Untracked target without Mode C
16. Primary target
17. Beacon target only (secondary radar) (transponder)
18. Primary and beacon target
19. Leader line
20. Altitude Mode C readout is 6,000'
(Note: readouts may not be displayed because of nonreceipt of beacon information, garbled beacon signals, and flight plan data which is displayed alternately with the altitude readout)
21. Ground speed readout is 240 knots
(Note: readouts may not be displayed because of a loss of beacon signal, a controller alert that a pilot was squawking emergency, radio failure, etc.)
22. Aircraft ID
23. Asterisk indicates a controller entry in Mode C block. In this case 5,000' is entered and "05" would alternate with Mode C readout.
24. Indicates heavy
25. "Low ALT" flashes to indicate when an aircraft's predicted descent places the aircraft in an unsafe proximity to terrain.
(Note: this feature does not function if the aircraft is not squawking Mode C. When a helicopter or aircraft is known to be operating below the lower safe limit, the "low ALT" can be changed to "inhibit" and flashing ceases.)
26. NAVAIDs
27. Airways
28. Primary target only
29. Nonmonitored. No Mode C (an asterisk would indicate nonmonitored with Mode C)
30. Beacon target only (secondary radar based on aircraft transponder)
31. Tracked target (primary and beacon target) control position A
32. Aircraft is squawking emergency Code 7700 and is nonmonitored, untracked, Mode C
33. Controller assigned runway 36 right alternates with Mode C readout
(Note: a three letter identifier could also indicate the arrival is at specific airport)
34. Ident flashes
35. Identifying target blossoms
36. Untracked target identifying on a selected code
37. Range marks (10 and 15 miles) (can be changed/offset)
38. Aircraft controlled by center
39. Targets in suspend status
40. Coast/suspend list (aircraft holding, temporary loss of beacon/target, etc.)
41. Radio failure (emergency information)
42. Select beacon codes (being monitored)
43. General information (ATIS, runway, approach in use)
44. Altimeter setting
45. Time
46. System data area

FIG 4-5-3
NAS Stage A Controllers View Plan Display

This figure illustrates the controller’s radar scope (PVD) when operating in the full automation (RDP) mode, which is normally 20 hours per day.

(When not in automation mode, the display is similar to the broadband mode shown in the ARTS III radar scope figure. Certain ARTCCs outside the contiguous U.S. also operate in “broadband” mode.)

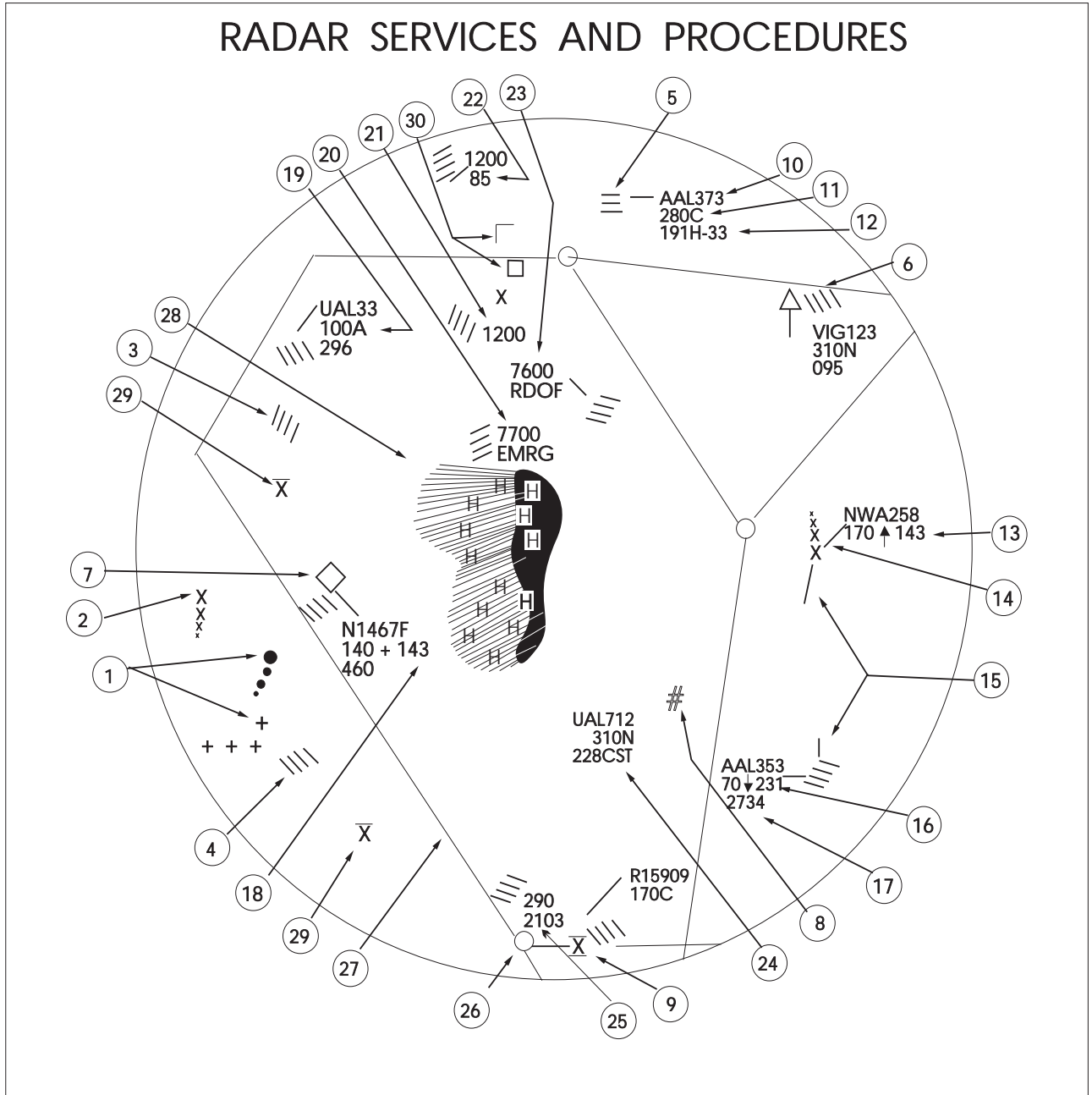

EXAMPLE-**Target symbols:**

1. Uncorrelated primary radar target [○] [+]
2. Correlated primary radar target [×]
*See note below.
3. Uncorrelated beacon target [/]
4. Correlated beacon target [\]
5. Identifying beacon target [≡]

*Note: in Number 2 correlated means the association of radar data with the computer projected track of an identified aircraft.

Position symbols:

6. Free track (no flight plan tracking) [△]
7. Flat track (flight plan tracking) [◇]
8. Coast (beacon target lost) [#]
9. Present position hold [⊠]

Data block information:

10. Aircraft ident
*See note below.
11. Assigned altitude FL 280, Mode C altitude same or within $\pm 200'$ of assigned altitude.
*See note below.
12. Computer ID #191, handoff is to sector 33
(0-33 would mean handoff accepted)
*See note below.
13. Assigned altitude 17,000', aircraft is climbing, Mode C readout was 14,300 when last beacon interrogation was received.
14. Leader line connecting target symbol and data block
15. Track velocity and direction vector line (projected ahead of target)

16. Assigned altitude 7,000, aircraft is descending, last Mode C readout (or last reported altitude) was 100' above FL 230

17. Transponder code shows in full data block only when different than assigned code

18. Aircraft is 300' above assigned altitude

19. Reported altitude (no Mode C readout) same as assigned. (An "n" would indicate no reported altitude.)

20. Transponder set on emergency Code 7700 (EMRG flashes to attract attention)

21. Transponder Code 1200 (VFR) with no Mode C

22. Code 1200 (VFR) with Mode C and last altitude readout

23. Transponder set on radio failure Code 7600 (RDOF flashes)

24. Computer ID #228, CST indicates target is in coast status

25. Assigned altitude FL 290, transponder code (these two items constitute a "limited data block")

*Note: numbers 10, 11, and 12 constitute a "full data block"

Other symbols:

26. Navigational aid
27. Airway or jet route
28. Outline of weather returns based on primary radar. "H" represents areas of high density precipitation which might be thunderstorms. Radial lines indicated lower density precipitation.
29. Obstruction
30. Airports
Major: □
Small: ▣

4-5-3. Surveillance Radar

a. Surveillance radars are divided into two general categories: Airport Surveillance Radar (ASR) and Air Route Surveillance Radar (ARSR).

1. ASR is designed to provide relatively short-range coverage in the general vicinity of an airport and to serve as an expeditious means of handling terminal area traffic through observation of precise aircraft locations on a radarscope. The ASR can also be used as an instrument approach aid.

2. ARSR is a long-range radar system designed primarily to provide a display of aircraft locations over large areas.

3. Center Radar Automated Radar Terminal Systems (ARTS) Processing (CENRAP) was developed to provide an alternative to a nonradar environment at terminal facilities should an ASR fail or malfunction. CENRAP sends aircraft radar beacon target information to the ASR terminal facility equipped with ARTS. Procedures used for the separation of aircraft may increase under certain conditions when a facility is utilizing CENRAP because radar target information updates at a slower rate than the normal ASR radar. Radar services for VFR aircraft are also limited during CENRAP operations because of the additional workload required to provide services to IFR aircraft.

b. Surveillance radars scan through 360 degrees of azimuth and present target information on a radar display located in a tower or center. This information is used independently or in conjunction with other navigational aids in the control of air traffic.

4-5-4. Precision Approach Radar (PAR)

a. PAR is designed for use as a landing aid rather than an aid for sequencing and spacing aircraft. PAR equipment may be used as a primary landing aid (See Chapter 5, Air Traffic Procedures, for additional information), or it may be used to monitor other types of approaches. It is designed to display range, azimuth, and elevation information.

b. Two antennas are used in the PAR array, one scanning a vertical plane, and the other scanning

horizontally. Since the range is limited to 10 miles, azimuth to 20 degrees, and elevation to 7 degrees, only the final approach area is covered. Each scope is divided into two parts. The upper half presents altitude and distance information, and the lower half presents azimuth and distance.

4-5-5. Airport Surface Detection Equipment (ASDE-X)/Airport Surface Surveillance Capability (ASSC)

a. ASDE-X/ASSC is a multi-sensor surface surveillance system the FAA is acquiring for airports in the United States. This system provides high resolution, short-range, clutter free surveillance information about aircraft and vehicles, both moving and fixed, located on or near the surface of the airport's runways and taxiways under all weather and visibility conditions. The system consists of:

1. **A Primary Radar System.** ASDE-X/ASSC system coverage includes the airport surface and the airspace up to 200 feet above the surface. Typically located on the control tower or other strategic location on the airport, the Primary Radar antenna is able to detect and display aircraft that are not equipped with or have malfunctioning transponders.

2. **Interfaces.** ASDE-X/ASSC contains an automation interface for flight identification via all automation platforms and interfaces with the terminal radar for position information.

3. **Automation.** A Multi-sensor Data Processor (MSDP) combines all sensor reports into a single target which is displayed to the air traffic controller.

4. **Air Traffic Control Tower Display.** A high resolution, color monitor in the control tower cab provides controllers with a seamless picture of airport operations on the airport surface.

b. The combination of data collected from the multiple sensors ensures that the most accurate information about aircraft location is received in the tower, thereby increasing surface safety and efficiency.

c. The following facilities are operational with ASDE-X:

TBL 4-5-1

BWI	Baltimore Washington International
BOS	Boston Logan International
BDL	Bradley International
MDW	Chicago Midway
ORD	Chicago O’Hare International
CLT	Charlotte Douglas International
DFW	Dallas/Fort Worth International
DEN	Denver International
DTW	Detroit Metro Wayne County
FLL	Fort Lauderdale/Hollywood Intl
MKE	General Mitchell International
IAH	George Bush International
ATL	Hartsfield–Jackson Atlanta Intl
HNL	Honolulu International
JFK	John F. Kennedy International
SNA	John Wayne–Orange County
LGA	LaGuardia
STL	Lambert St. Louis International
LAS	Las Vegas McCarran International
LAX	Los Angeles International
SDF	Louisville International
MEM	Memphis International
MIA	Miami International
MSP	Minneapolis St. Paul International
EWR	Newark International
MCO	Orlando International
PHL	Philadelphia International
PHX	Phoenix Sky Harbor International
DCA	Ronald Reagan Washington National
SAN	San Diego International
SLC	Salt Lake City International
SEA	Seattle–Tacoma International
PVD	Theodore Francis Green State
IAD	Washington Dulles International
HOU	William P. Hobby International

d. The following facilities have been projected to receive ASSC:

TBL 4-5-2

SFO	San Francisco International
CLE	Cleveland–Hopkins International
MCI	Kansas City International
CVG	Cincinnati/Northern Kentucky Intl
PDX	Portland International
MSY	Louis Armstrong New Orleans Intl
PIT	Pittsburgh International
ANC	Ted Stevens Anchorage International
ADW	Joint Base Andrews AFB

4-5-6. Traffic Information Service (TIS)

a. Introduction.

The Traffic Information Service (TIS) provides information to the cockpit via data link, that is similar to VFR radar traffic advisories normally received over voice radio. Among the first FAA-provided data services, TIS is intended to improve the safety and efficiency of “see and avoid” flight through an automatic display that informs the pilot of nearby traffic and potential conflict situations. This traffic display is intended to assist the pilot in visual acquisition of these aircraft. TIS employs an enhanced capability of the terminal Mode S radar system, which contains the surveillance data, as well as the data link required to “uplink” this information to suitably-equipped aircraft (known as a TIS “client”). TIS provides estimated position, altitude, altitude trend, and ground track information for up to 8 intruder aircraft within 7 NM horizontally, +3,500 and -3,000 feet vertically of the client aircraft (see FIG 4-5-4, TIS Proximity Coverage Volume). The range of a target reported at a distance greater than 7 NM only indicates that this target will be a threat within 34 seconds and does not display an precise distance. TIS will alert the pilot to aircraft (under surveillance of the Mode S radar) that are estimated to be within 34 seconds of potential collision, regardless of distance of altitude. TIS surveillance data is derived from the same radar used by ATC; this data is uplinked to the client aircraft on each radar scan (nominally every 5 seconds).

b. Requirements.

1. In order to use TIS, the client and any intruder aircraft must be equipped with the appropriate cockpit equipment and fly within the radar coverage volume of a Mode S radar capable of providing TIS.

Typically, this will be within 55 NM of the sites depicted in FIG 4-5-5, Terminal Mode S Radar Sites. ATC communication is not a requirement to receive TIS, although it may be required by the particular airspace or flight operations in which TIS is being used.

**FIG 4-5-4
TIS Proximity Coverage Volume**

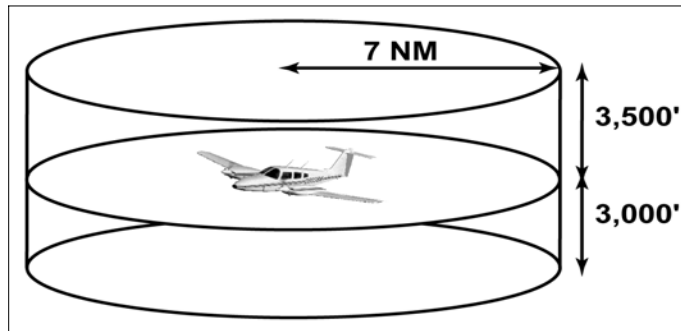

**FIG 4-5-5
Terminal Mode S Radar Sites**

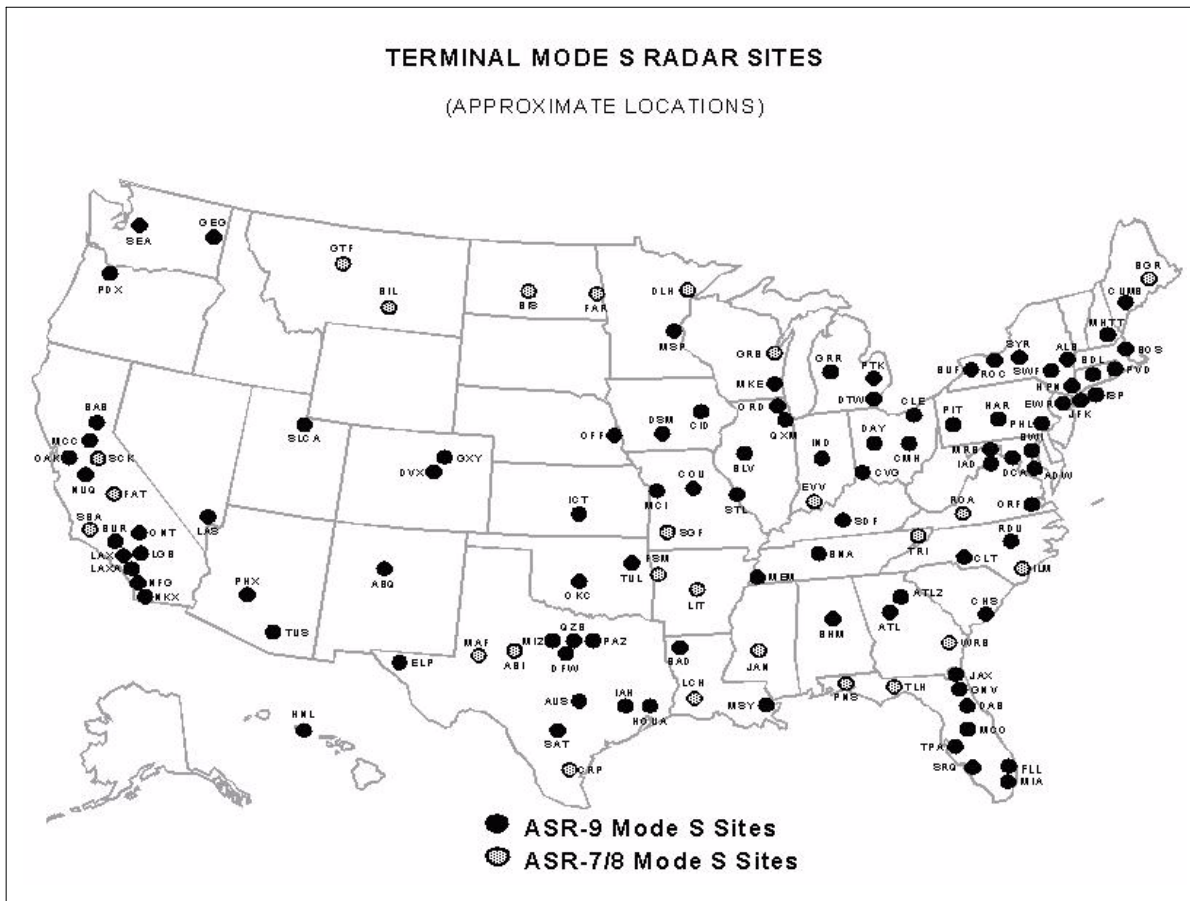
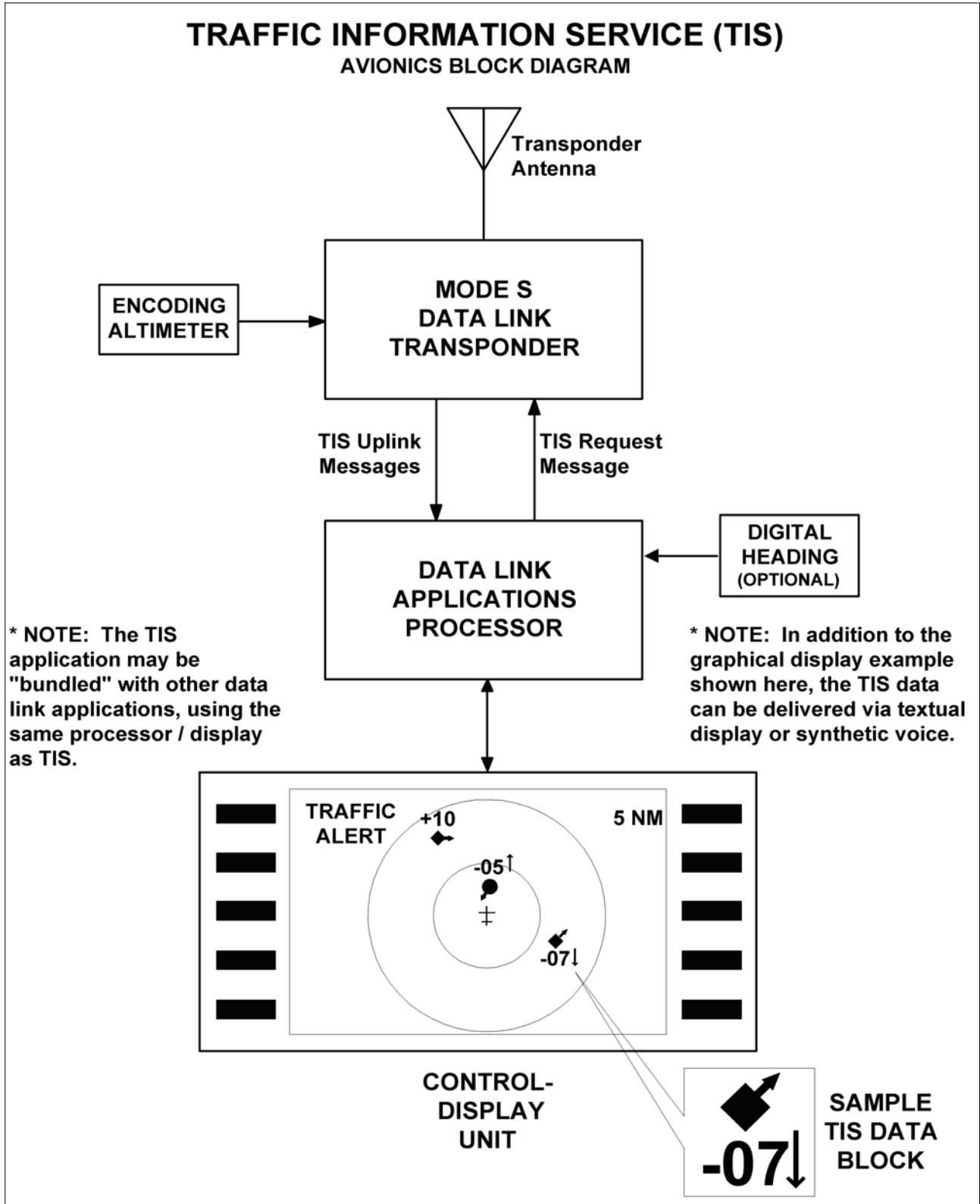

FIG 4-5-6
Traffic Information Service (TIS)
Avionics Block Diagram



2. The cockpit equipment functionality required by a TIS client aircraft to receive the service consists of the following (refer to FIG 4-5-6):

(a) Mode S data link transponder with altitude encoder.

(b) Data link applications processor with TIS software installed.

(c) Control–display unit.

(d) Optional equipment includes a digital heading source to correct display errors caused by “crab angle” and turning maneuvers.

NOTE–

Some of the above functions will likely be combined into single pieces of avionics, such as (a) and (b).

3. To be visible to the TIS client, the intruder aircraft must, at a minimum, have an operating transponder (Mode A, C or S). All altitude information provided by TIS from intruder aircraft is derived from Mode C reports, if appropriately equipped.

4. TIS will initially be provided by the terminal Mode S systems that are paired with ASR-9 digital primary radars. These systems are in locations with the greatest traffic densities, thus will provide the greatest initial benefit. The remaining terminal Mode S sensors, which are paired with ASR-7 or ASR-8 analog primary radars, will provide TIS pending modification or relocation of these sites. See FIG 4-5-5, Terminal Mode S Radar Sites, for site locations. There is no mechanism in place, such as NOTAMs, to provide status update on individual radar sites since TIS is a nonessential, supplemental information service.

The FAA also operates en route Mode S radars (not illustrated) that rotate once every 12 seconds. These sites will require additional development of TIS before any possible implementation. There are no plans to implement TIS in the en route Mode S radars at the present time.

c. Capabilities.

1. TIS provides ground–based surveillance information over the Mode S data link to properly equipped client aircraft to aid in visual acquisition of proximate air traffic. The actual avionics capability of each installation will vary and the supplemental handbook material must be consulted prior to using

TIS. A maximum of eight (8) intruder aircraft may be displayed; if more than eight aircraft match intruder parameters, the eight “most significant” intruders are uplinked. These “most significant” intruders are usually the ones in closest proximity and/or the greatest threat to the TIS client.

2. TIS, through the Mode S ground sensor, provides the following data on each intruder aircraft:

(a) Relative bearing information in 6–degree increments.

(b) Relative range information in 1/8 NM to 1 NM increments (depending on range).

(c) Relative altitude in 100–foot increments (within 1,000 feet) or 500–foot increments (from 1,000–3,500 feet) if the intruder aircraft has operating altitude reporting capability.

(d) Estimated intruder ground track in 45–degree increments.

(e) Altitude trend data (level within 500 fpm or climbing/descending >500 fpm) if the intruder aircraft has operating altitude reporting capability.

(f) Intruder priority as either an “traffic advisory” or “proximate” intruder.

3. When flying from surveillance coverage of one Mode S sensor to another, the transfer of TIS is an automatic function of the avionics system and requires no action from the pilot.

4. There are a variety of status messages that are provided by either the airborne system or ground equipment to alert the pilot of high priority intruders and data link system status. These messages include the following:

(a) **Alert.** Identifies a potential collision hazard within 34 seconds. This alert may be visual and/or audible, such as a flashing display symbol or a headset tone. A target is a threat if the time to the closest approach in vertical and horizontal coordinates is less than 30 seconds and the closest approach is expected to be within 500 feet vertically and 0.5 nautical miles laterally.

(b) **TIS Traffic.** TIS traffic data is displayed.

(c) **Coasting.** The TIS display is more than 6 seconds old. This indicates a missing uplink from the ground system. When the TIS display information is more than 12 seconds old, the “No Traffic” status will be indicated.

(d) No Traffic. No intruders meet proximate or alert criteria. This condition may exist when the TIS system is fully functional or may indicate “coasting” between 12 and 59 seconds old (see (c) above).

(e) TIS Unavailable. The pilot has requested TIS, but no ground system is available. This condition will also be displayed when TIS uplinks are missing for 60 seconds or more.

(f) TIS Disabled. The pilot has not requested TIS or has disconnected from TIS.

(g) Good-bye. The client aircraft has flown outside of TIS coverage.

NOTE–

Depending on the avionics manufacturer implementation, it is possible that some of these messages will not be directly available to the pilot.

5. Depending on avionics system design, TIS may be presented to the pilot in a variety of different displays, including text and/or graphics. Voice annunciation may also be used, either alone or in combination with a visual display. FIG 4–5–6, Traffic Information Service (TIS), Avionics Block Diagram, shows an example of a TIS display using symbology similar to the Traffic Alert and Collision Avoidance System (TCAS) installed on most passenger air carrier/commuter aircraft in the U.S. The small symbol in the center represents the client aircraft and the display is oriented “track up,” with the 12 o’clock position at the top. The range rings indicate 2 and 5 NM. Each intruder is depicted by a symbol positioned at the approximate relative bearing and range from the client aircraft. The circular symbol near the center indicates an “alert” intruder and the diamond symbols indicate “proximate” intruders.

6. The inset in the lower right corner of FIG 4–5–6, Traffic Information Service (TIS), Avionics Block Diagram, shows a possible TIS data block display. The following information is contained in this data block:

(a) The intruder, located approximately four o’clock, three miles, is a “proximate” aircraft and currently not a collision threat to the client aircraft. This is indicated by the diamond symbol used in this example.

(b) The intruder ground track diverges to the right of the client aircraft, indicated by the small arrow.

(c) The intruder altitude is 700 feet less than or below the client aircraft, indicated by the “–07” located under the symbol.

(d) The intruder is descending >500 fpm, indicated by the downward arrow next to the “–07” relative altitude information. The absence of this arrow when an altitude tag is present indicates level flight or a climb/descent rate less than 500 fpm.

NOTE–

If the intruder did not have an operating altitude encoder (Mode C), the altitude and altitude trend “tags” would have been omitted.

d. Limitations.

1. TIS is **NOT** intended to be used as a collision avoidance system and does not relieve the pilot responsibility to “see and avoid” other aircraft (see paragraph 5–5–8, See and Avoid). TIS must not be for avoidance maneuvers during IMC or other times when there is no visual contact with the intruder aircraft. TIS is intended only to assist in visual acquisition of other aircraft in VMC. **No recommended avoidance maneuvers are provided for, nor authorized, as a direct result of a TIS intruder display or TIS alert.**

2. While TIS is a useful aid to visual traffic avoidance, it has some system limitations that must be fully understood to ensure proper use. Many of these limitations are inherent in secondary radar surveillance. In other words, the information provided by TIS will be no better than that provided to ATC. Other limitations and anomalies are associated with the TIS predictive algorithm.

(a) Intruder Display Limitations. TIS will only display aircraft with operating transponders installed. TIS relies on surveillance of the Mode S radar, which is a “secondary surveillance” radar similar to the ATCRBS described in paragraph 4–5–2.

(b) TIS Client Altitude Reporting Requirement. Altitude reporting is required by the TIS client aircraft in order to receive TIS. If the altitude encoder is inoperative or disabled, TIS will be unavailable, as TIS requests will not be honored by the ground system. As such, TIS requires altitude reporting to determine the Proximity Coverage Volume as

indicated in FIG 4-5-4. TIS users must be alert to altitude encoder malfunctions, as TIS has no mechanism to determine if client altitude reporting is correct. A failure of this nature will cause erroneous and possibly unpredictable TIS operation. If this malfunction is suspected, confirmation of altitude reporting with ATC is suggested.

(c) Intruder Altitude Reporting. Intruders without altitude reporting capability will be displayed without the accompanying altitude tag. Additionally, nonaltitude reporting intruders are assumed to be at the same altitude as the TIS client for alert computations. This helps to ensure that the pilot will be alerted to all traffic under radar coverage, but the actual altitude difference may be substantial. Therefore, visual acquisition may be difficult in this instance.

(d) Coverage Limitations. Since TIS is provided by ground-based, secondary surveillance radar, it is subject to all limitations of that radar. If an aircraft is not detected by the radar, it cannot be displayed on TIS. Examples of these limitations are as follows:

(1) TIS will typically be provided within 55 NM of the radars depicted in FIG 4-5-5, Terminal Mode S Radar Sites. This maximum range can vary by radar site and is always subject to “line of sight” limitations; the radar and data link signals will be blocked by obstructions, terrain, and curvature of the earth.

(2) TIS will be unavailable at low altitudes in many areas of the country, particularly in mountainous regions. Also, when flying near the “floor” of radar coverage in a particular area, intruders below the client aircraft may not be detected by TIS.

(3) TIS will be temporarily disrupted when flying directly over the radar site providing coverage if no adjacent site assumes the service. A ground-based radar, like a VOR or NDB, has a zenith cone, sometimes referred to as the cone of confusion or cone of silence. This is the area of ambiguity directly above the station where bearing information is unreliable. The zenith cone setting for TIS is 34 degrees: Any aircraft above that angle with respect to the radar horizon will lose TIS coverage from that radar until it is below this 34 degree angle. The aircraft may not actually lose service in areas of

multiple radar coverage since an adjacent radar will provide TIS. If no other TIS-capable radar is available, the “Good-bye” message will be received and TIS terminated until coverage is resumed.

(e) Intermittent Operations. TIS operation may be intermittent during turns or other maneuvering, particularly if the transponder system does not include antenna diversity (antenna mounted on the top and bottom of the aircraft). As in (d) above, TIS is dependent on two-way, “line of sight” communications between the aircraft and the Mode S radar. Whenever the structure of the client aircraft comes between the transponder antenna (usually located on the underside of the aircraft) and the ground-based radar antenna, the signal may be temporarily interrupted.

(f) TIS Predictive Algorithm. TIS information is collected one radar scan prior to the scan during which the uplink occurs. Therefore, the surveillance information is approximately 5 seconds old. In order to present the intruders in a “real time” position, TIS uses a “predictive algorithm” in its tracking software. This algorithm uses track history data to extrapolate intruders to their expected positions consistent with the time of display in the cockpit. Occasionally, aircraft maneuvering will cause this algorithm to induce errors in the TIS display. These errors primarily affect relative bearing information; intruder distance and altitude will remain relatively accurate and may be used to assist in “see and avoid.” Some of the more common examples of these errors are as follows:

(1) When client or intruder aircraft maneuver excessively or abruptly, the tracking algorithm will report incorrect horizontal position until the maneuvering aircraft stabilizes.

(2) When a rapidly closing intruder is on a course that crosses the client at a shallow angle (either overtaking or head on) and either aircraft abruptly changes course within $\frac{1}{4}$ NM, TIS will display the intruder on the opposite side of the client than it actually is.

These are relatively rare occurrences and will be corrected in a few radar scans once the course has stabilized.

(g) Heading/Course Reference. Not all TIS aircraft installations will have onboard heading reference information. In these installations, aircraft course reference to the TIS display is provided by the

Mode S radar. The radar only determines ground track information and has no indication of the client aircraft heading. In these installations, all intruder bearing information is referenced to ground track and does not account for wind correction. Additionally, since ground-based radar will require several scans to determine aircraft course following a course change, a lag in TIS display orientation (intruder aircraft bearing) will occur. As in (f) above, intruder distance and altitude are still usable.

(h) Closely-Spaced Intruder Errors.

When operating more than 30 NM from the Mode S sensor, TIS forces any intruder within 3/8 NM of the TIS client to appear at the same horizontal position as the client aircraft. Without this feature, TIS could display intruders in a manner confusing to the pilot in critical situations (e.g., a closely-spaced intruder that is actually to the right of the client may appear on the TIS display to the left). At longer distances from the radar, TIS cannot accurately determine relative bearing/distance information on intruder aircraft that are in close proximity to the client.

Because TIS uses a ground-based, rotating radar for surveillance information, the accuracy of TIS data is dependent on the distance from the sensor (radar) providing the service. This is much the same phenomenon as experienced with ground-based navigational aids, such as VOR or NDB. As distance from the radar increases, the accuracy of surveillance decreases. Since TIS does not inform the pilot of distance from the Mode S radar, the pilot must assume that any intruder appearing at the same position as the client aircraft may actually be up to 3/8 NM away in any direction. Consistent with the operation of TIS, an alert on the display (regardless of distance from the radar) should stimulate an outside visual scan, intruder acquisition, and traffic avoidance based on outside reference.

e. Reports of TIS Malfunctions.

1. Users of TIS can render valuable assistance in the early correction of malfunctions by reporting their observations of undesirable performance. Reporters should identify the time of observation, location, type and identity of aircraft, and describe the condition observed; the type of transponder processor, and software in use can also be useful information. Since TIS performance is monitored by maintenance personnel rather than ATC, it is suggested that

malfunctions be reported by radio or telephone to the nearest Flight Service Station (FSS) facility.

4-5-7. Automatic Dependent Surveillance-Broadcast (ADS-B) Services

a. Introduction.

1. Automatic Dependent Surveillance-Broadcast (ADS-B) is a surveillance technology deployed throughout the NAS (see FIG 4-5-7). The ADS-B system is composed of aircraft avionics and a ground infrastructure. Onboard avionics determine the position of the aircraft by using the GNSS and transmit its position along with additional information about the aircraft to ground stations for use by ATC and other ADS-B services. This information is transmitted at a rate of approximately once per second. (See FIG 4-5-8 and FIG 4-5-9.)

2. In the United States, ADS-B equipped aircraft exchange information is on one of two frequencies: 978 or 1090 MHz. The 1090 MHz frequency is associated with Mode A, C, and S transponder operations. 1090 MHz transponders with integrated ADS-B functionality extend the transponder message sets with additional ADS-B information. This additional information is known as an “extended squitter” message and referred to as 1090ES. ADS-B equipment operating on 978 MHz is known as the Universal Access Transceiver (UAT).

3. ADS B avionics can have the ability to both transmit and receive information. The transmission of ADS-B information from an aircraft is known as ADS-B Out. The receipt of ADS-B information by an aircraft is known as ADS-B In. On January 1, 2020, all aircraft operating within the airspace defined in 14 CFR Part 91 § 91.225 will be required to transmit the information defined in § 91.227 using ADS-B Out avionics.

4. In general, operators flying at 18,000 feet and above will require equipment which uses 1090 ES. Those that do not fly above 18,000 may use either UAT or 1090ES equipment. (Refer to 14 CFR 91.225 and 91.227.) While the regulation will not require it, operators equipped with ADS-B In will realize additional benefits from ADS-B broadcast services: Traffic Information Service – Broadcast (TIS-B) (Paragraph 4-5-8) and Flight Information Service – Broadcast (FIS-B) (Paragraph 4-5-9).

**FIG 4-5-7
ADS-B, TIS-B, and FIS-B:
Broadcast Services Architecture**

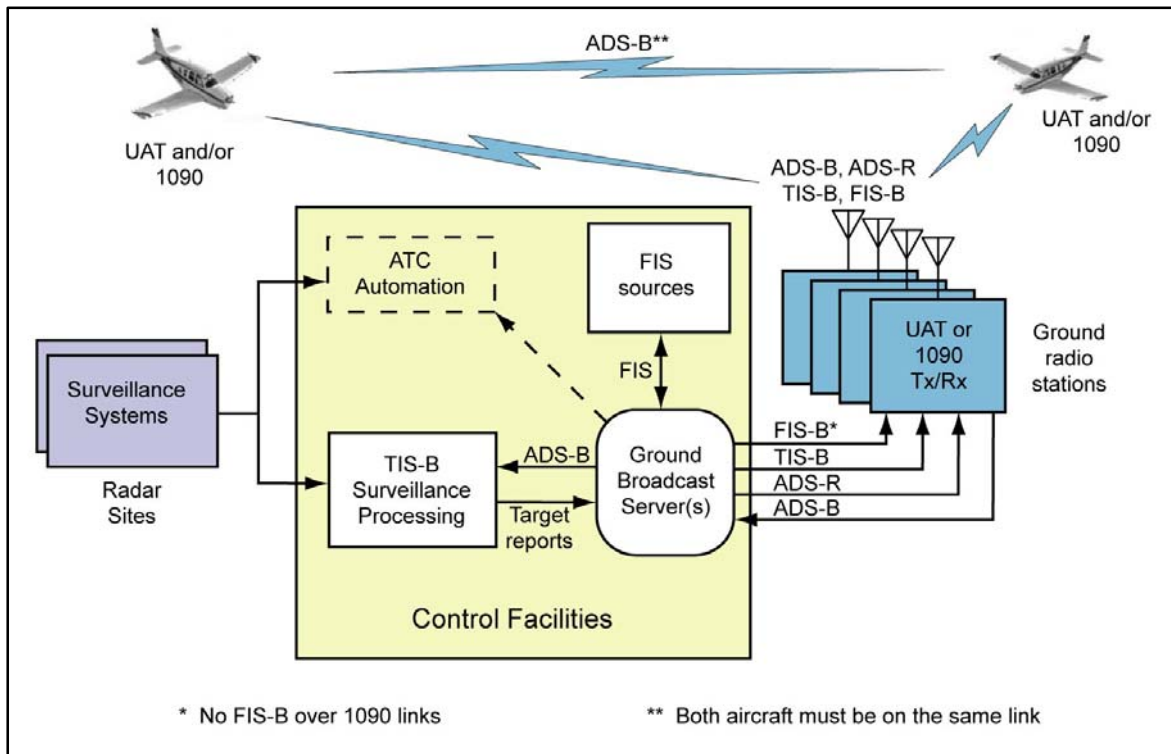

b. ADS-B Certification and Performance Requirements.

ADS-B equipment may be certified as a surveillance source for air traffic separation services using ADS-B Out. ADS-B equipment may also be certified for use with ADS-B In advisory services that enable appropriately equipped aircraft to display traffic and flight information. Refer to the aircraft’s flight manual supplement or Pilot Operating Handbook for the capabilities of a specific aircraft installation.

c. ADS-B Capabilities and Procedures.

1. ADS-B enables improved surveillance services, both air-to-air and air-to-ground, especially in areas where radar is ineffective due to terrain or where it is impractical or cost prohibitive. Initial NAS applications of air-to-air ADS-B are for “advisory” use only, enhancing a pilot’s visual acquisition of other nearby equipped aircraft either when airborne or on the airport surface. Additionally, ADS-B will enable ATC and fleet operators to monitor aircraft throughout the available ground station coverage area.

FIG 4-5-8
En Route – ADS-B/ADS-R/TIS-B/FIS-B Service Ceilings/Floors

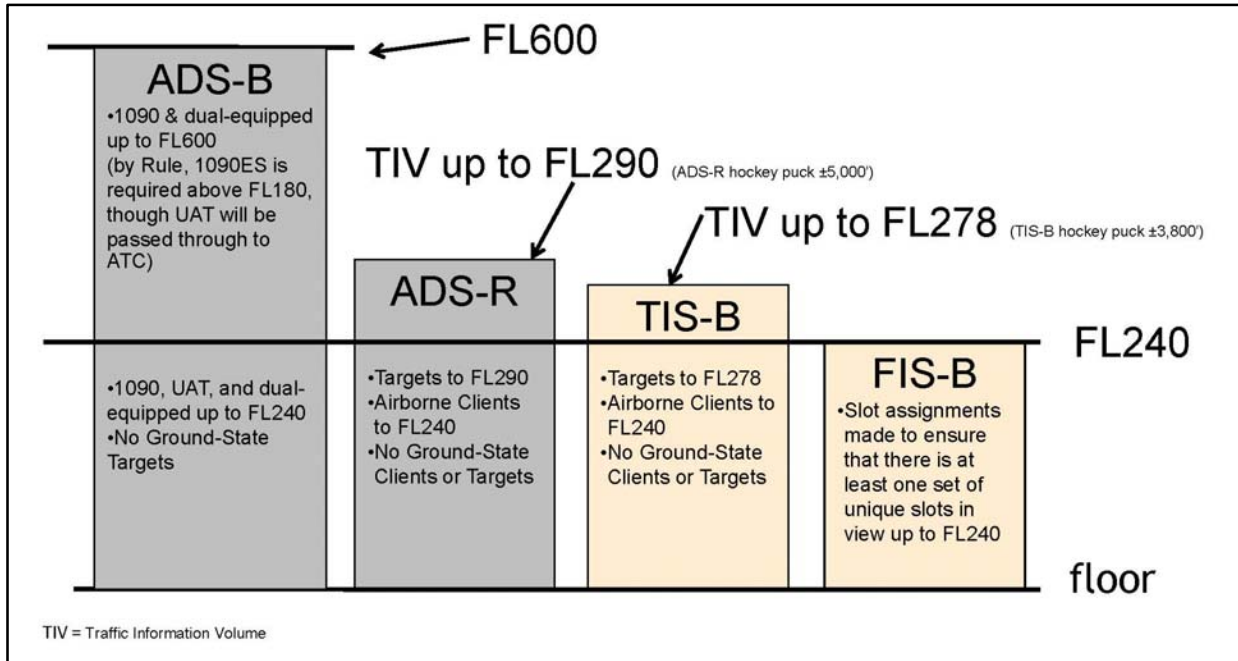
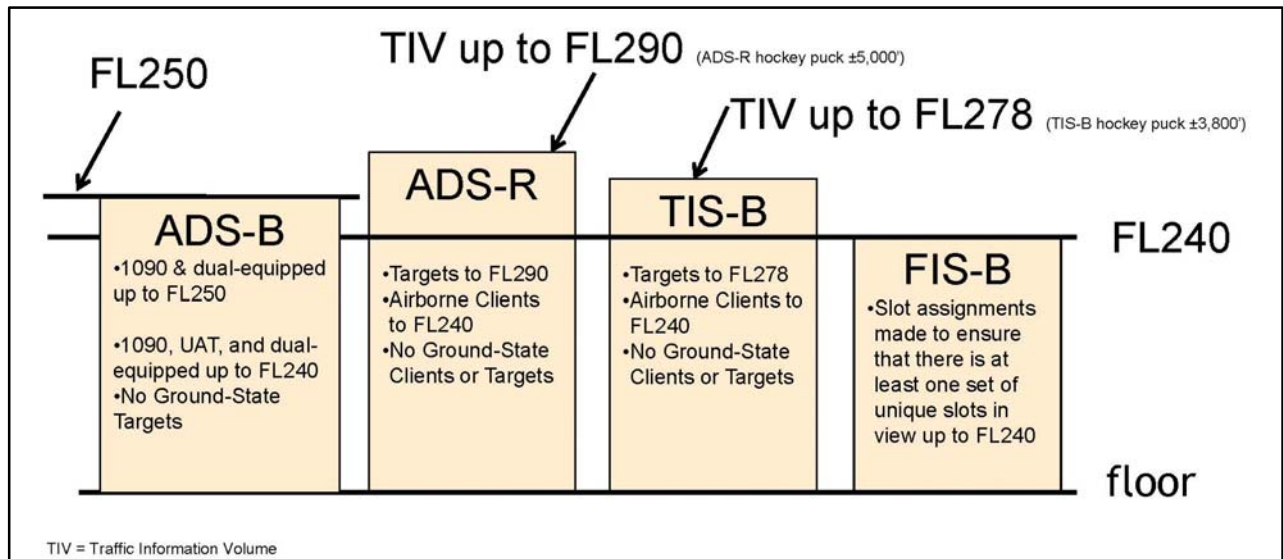

FIG 4-5-9
Terminal – ADS-B/ADS-R/TIS-B/FIS-B Service Ceilings/Floors



2. One of the data elements transmitted by ADS-B is the aircraft's Flight Identification (FLT ID). The FLT ID is comprised of a maximum of seven alphanumeric characters and must correspond to the aircraft identification filed in the flight plan. For airline and commuter aircraft, the FLT ID is usually the company name and flight number (for example, AAL3432), and is typically entered into the avionics by the flight crew during preflight. For general aviation (GA), if aircraft avionics allow dynamic modification of the FLT ID, the pilot can enter it prior to flight. However, some ADS-B avionics require the FLT ID to be set to the aircraft registration number (for example, N1234Q) by the installer and cannot be changed by the pilot from the cockpit. In both cases, the FLT ID must correspond to the aircraft identification filed in its flight plan.

ATC automation systems use the transmitted ADS-B FLT ID to uniquely identify each aircraft within a given airspace, and to correlate it to its filed flight plan for the purpose of providing surveillance and separation services. If the FLT ID and the filed aircraft identification are not identical, a Call Sign Mis-Match (CSMM) is generated and ATC automation systems may not associate the aircraft with its filed flight plan. In this case, air traffic services may be delayed or unavailable until the CSMM is corrected. Consequently, it is imperative that flight crews and GA pilots ensure the FLT ID entry correctly matches the aircraft identification filed in their flight plan.

3. Each ADS-B aircraft is assigned a unique ICAO address (also known as a 24-bit address) that is broadcast by the ADS-B transmitter. This ICAO address is programmed at installation. Should multiple aircraft broadcast the same ICAO address while transiting the same ADS-B Only Service Volume, the ADS-B network may be unable to track the targets correctly. If radar reinforcement is available, tracking will continue. If radar is unavailable, the controller may lose target tracking entirely on one or both targets. Consequently, it is imperative that the ICAO address entry is correct. Aircraft that are equipped with ADS-B avionics on the UAT datalink have a feature that allows them to broadcast an anonymous 24-bit ICAO address. In this mode, the UAT system creates a randomized address that does not match the actual ICAO address

assigned to the aircraft. After January 1, 2020, and in the airspace identified in 14 CFR 91.225, the UAT anonymous 24-bit address feature may only be used when the operator has not filed a flight plan and is not requesting ATC services. In the anonymity mode, the aircraft's beacon code must be set to 1200 and, depending on the manufacturer's implementation, the aircraft FLT ID might not be transmitted. Operators should be aware that in UAT anonymous mode, they will not be eligible to receive ATC separation and flight-following services and will likely not benefit from enhanced ADS-B search and rescue capabilities.

4. ADS-B systems integrated with the transponder will automatically set the applicable emergency status when 7500, 7600, or 7700 are entered into the transponder. ADS-B systems not integrated with the transponder, or systems with optional emergency codes, will require that the appropriate emergency code is entered through a pilot interface. ADS-B is intended for inflight and airport surface use. ADS-B systems should be turned "on" and remain "on" whenever operating in the air and moving on the airport surface. Civilian and military Mode A/C transponders and ADS-B systems should be adjusted to the "on" or normal operating position as soon as practical, unless the change to "standby" has been accomplished previously at the request of ATC.

d. ATC Surveillance Services using ADS-B – Procedures and Recommended Phraseology

Radar procedures, with the exceptions found in this paragraph, are identical to those procedures prescribed for radar in AIM Chapter 4 and Chapter 5.

1. Preflight:

If ATC services are anticipated when either a VFR or IFR flight plan is filed, the aircraft identification (as entered in the flight plan) must be entered as the FLT ID in the ADS-B avionics.

2. Inflight:

When requesting surveillance services while airborne, pilots must disable the anonymous feature, if so equipped, prior to contacting ATC. Pilots must also ensure that their transmitted ADS-B FLT ID matches the aircraft identification as entered in their flight plan.

3. Aircraft with an Inoperative/Malfunctioning ADS-B Transmitter:

(a) ATC will inform the flight crew when the aircraft's ADS-B transmitter appears to be inoperative or malfunctioning:

PHRASEOLOGY-

YOUR ADS-B TRANSMITTER APPEARS TO BE INOPERATIVE/MALFUNCTIONING. STOP ADS-B TRANSMISSIONS.

(b) ATC will inform the flight crew if it becomes necessary to turn off the aircraft's ADS-B transmitter.

PHRASEOLOGY-

STOP ADS-B TRANSMISSIONS.

(c) Other malfunctions and considerations:

Loss of automatic altitude reporting capabilities (encoder failure) will result in loss of ATC altitude advisory services.

e. ADS-B Limitations.

1. The ADS-B cockpit display of traffic is NOT intended to be used as a collision avoidance system and does not relieve the pilot's responsibility to "see and avoid" other aircraft. (See paragraph 5-5-8, See and Avoid). ADS-B must not be used for avoidance maneuvers during IMC or other times when there is no visual contact with the intruder aircraft. ADS-B is intended only to assist in visual acquisition of other aircraft. No avoidance maneuvers are provided nor authorized, as a direct result of an ADS-B target being displayed in the cockpit.

2. Use of ADS-B radar services is limited to the service volume of the GBT.

NOTE-

The coverage volume of GBTs are limited to line-of-sight.

f. Reports of ADS-B Malfunctions.

Users of ADS-B can provide valuable assistance in the correction of malfunctions by reporting instances of undesirable system performance. Since ADS-B performance is monitored by maintenance personnel rather than ATC, report malfunctions to the nearest Flight Service Station (FSS) facility by radio or telephone. Reporters should identify:

1. Condition observed.
2. Date and time of observation.
3. Altitude and location of observation.

4. Type and call sign of the aircraft.

5. Type and software version of avionics system.

4-5-8. Traffic Information Service-Broadcast (TIS-B)

a. Introduction

TIS-B is the broadcast of ATC derived traffic information to ADS-B equipped (1090ES or UAT) aircraft from ground radio stations. The source of this traffic information is derived from ground-based air traffic surveillance sensors. TIS-B service will be available throughout the NAS where there are both adequate surveillance coverage from ground sensors and adequate broadcast coverage from ADS-B ground radio stations. The quality level of traffic information provided by TIS-B is dependent upon the number and type of ground sensors available as TIS-B sources and the timeliness of the reported data. (See FIG 4-5-8 and FIG 4-5-9.)

b. TIS-B Requirements.

In order to receive TIS-B service, the following conditions must exist:

1. Aircraft must be equipped with an ADS-B transmitter/receiver or transceiver, and a cockpit display of traffic information (CDTI).

2. Aircraft must fly within the coverage volume of a compatible ground radio station that is configured for TIS-B uplinks. (Not all ground radio stations provide TIS-B due to a lack of radar coverage or because a radar feed is not available).

3. Aircraft must be within the coverage of and detected by at least one ATC radar serving the ground radio station in use.

c. TIS-B Capabilities.

1. TIS-B is intended to provide ADS-B equipped aircraft with a more complete traffic picture in situations where not all nearby aircraft are equipped with ADS-B Out. This advisory-only application is intended to enhance a pilot's visual acquisition of other traffic.

2. Only transponder-equipped targets (i.e., Mode A/C or Mode S transponders) are transmitted through the ATC ground system architecture. Current radar siting may result in limited radar surveillance coverage at lower

altitudes near some airports, with subsequently limited TIS-B service volume coverage. If there is no radar coverage in a given area, then there will be no TIS-B coverage in that area.

d. TIS-B Limitations.

1. TIS-B is NOT intended to be used as a collision avoidance system and does not relieve the pilot's responsibility to "see and avoid" other aircraft, in accordance with 14CFR §91.113b. TIS-B must not be used for avoidance maneuvers during times when there is no visual contact with the intruder aircraft. TIS-B is intended only to assist in the visual acquisition of other aircraft.

NOTE-

No aircraft avoidance maneuvers are authorized as a direct result of a TIS-B target being displayed in the cockpit.

2. While TIS-B is a useful aid to visual traffic avoidance, its inherent system limitations must be understood to ensure proper use.

(a) A pilot may receive an intermittent TIS-B target of themselves, typically when maneuvering (e.g., climbing turns) due to the radar not tracking the aircraft as quickly as ADS-B.

(b) The ADS-B-to-radar association process within the ground system may at times have difficulty correlating an ADS-B report with corresponding radar returns from the same aircraft. When this happens the pilot may see duplicate traffic symbols (i.e., "TIS-B shadows") on the cockpit display.

(c) Updates of TIS-B traffic reports will occur less often than ADS-B traffic updates. TIS-B position updates will occur approximately once every 3–13 seconds depending on the type of radar system in use within the coverage area. In comparison, the update rate for ADS-B is nominally once per second.

(d) The TIS-B system only uplinks data pertaining to transponder-equipped aircraft. Aircraft without a transponder will not be displayed as TIS-B traffic.

(e) There is no indication provided when any aircraft is operating inside or outside the TIS-B

service volume, therefore it is difficult to know if one is receiving uplinked TIS-B traffic information.

3. Pilots and operators are reminded that the airborne equipment that displays TIS-B targets is for pilot situational awareness only and is not approved as a collision avoidance tool. Unless there is an imminent emergency requiring immediate action, any deviation from an air traffic control clearance in response to perceived converging traffic appearing on a TIS-B display must be approved by the controlling ATC facility before commencing the maneuver, except as permitted under certain conditions in 14CFR §91.123. Uncoordinated deviations may place an aircraft in close proximity to other aircraft under ATC control not seen on the airborne equipment and may result in a pilot deviation or other incident.

e. Reports of TIS-B Malfunctions.

Users of TIS-B can provide valuable assistance in the correction of malfunctions by reporting instances of undesirable system performance. Since TIS-B performance is monitored by maintenance personnel rather than ATC, report malfunctions to the nearest Flight Service Station (FSS) facility by radio or telephone. Reporters should identify:

1. Condition observed.
2. Date and time of observation.
3. Altitude and location of observation.
4. Type and call sign of the aircraft.
5. Type and software version of avionics system.

4-5-9. Flight Information Service-Broadcast (FIS-B)

a. Introduction.

FIS-B is a ground broadcast service provided through the ADS-B Services network over the 978 MHz UAT data link. The FAA FIS-B system provides pilots and flight crews of properly equipped aircraft with a cockpit display of certain aviation weather and aeronautical information. FIS-B reception is line-of-sight within the service volume of the ground infrastructure. (See FIG 4-5-8 and FIG 4-5-9.)

b. Weather Products.

FIS-B does not replace a preflight weather briefing from a source listed in Paragraph 7-1-2, FAA Weather Services, or inflight updates from an FSS or ATC. FIS-B information may be used by the pilot for the safe conduct of flight and aircraft movement; however, the information should not be the only source of weather or aeronautical information. A pilot should be particularly alert and understand the limitations and quality assurance issues associated with individual products. This includes graphical representation of next generation weather radar (NEXRAD) imagery and Notices to Airmen (NOTAM)/temporary flight restrictions (TFR).

REFERENCE-
 AIM, Paragraph 7-1-11, Flight Information Services
 Advisory Circular (AC) 00-63, "Use of Cockpit Displays of Digital Weather and Aeronautical Information"

c. Reports of FIS-B Malfunctions.

Users of FIS-B can provide valuable assistance in the correction of malfunctions by reporting instances of undesirable system performance. Since FIS-B performance is monitored by maintenance personnel rather than ATC, report malfunctions to the nearest Flight Service Station (FSS) facility by radio or telephone. Reporters should identify:

1. Condition observed.
2. Date and time of observation.
3. Altitude and location of observation.
4. Type and call sign of the aircraft.
5. Type and software version of avionics system.

TBL 4-5-3

FIS-B Basic Product Update and Transmission Intervals

Product	FIS-B Service Update Interval¹	FIS-B Service Transmission Interval²
AIRMET	As available	5 minutes
Convective SIGMET	As available	5 minutes
METAR/SPECI	Hourly/as available	5 minutes
NEXRAD Reflectivity (CONUS)	5 minutes	15 minutes
NEXRAD Reflectivity (Regional)	5 minutes	2.5 minutes
NOTAM-D/FDC	As available	10 minutes
PIREP	As available	10 minutes
SIGMET	As available	5 minutes
SUA Status	As available	10 minutes
TAF/AMEND	8 hours/as available	10 minutes
Temperature Aloft	6 hours	10 minutes
Winds Aloft	6 hours	10 minutes

¹ The Update Interval is the rate at which the product data is available from the source.

² The Transmission Interval is the amount of time within which a new or updated product transmission must be completed and the rate or repetition interval at which the product is rebroadcast.

NOTE-
 Details concerning the content, format, and symbols of the various data link products provided should be obtained from the specific avionics manufacturer.

4-5-10. Automatic Dependent Surveillance-Rebroadcast (ADS-R)

a. Introduction.

ADS-R is a datalink translation function of the ADS-B ground system required to accommodate the two separate operating frequencies (978 MHz and 1090 ES). The ADS-B system receives the ADS-B messages transmitted on one frequency and ADS-R translates and reformats the information for rebroadcast and use on the other frequency. This allows ADS-B In equipped aircraft to see nearby ADS-B Out traffic regardless of the operating link of the other aircraft. Aircraft operating on the same ADS-B frequency exchange information directly and do not require the ADS-R translation function. (See FIG 4-5-8 and FIG 4-5-9.)

b. Reports of ADS-R Malfunctions.

Users of ADS-R can provide valuable assistance in the correction of malfunctions by reporting instances of undesirable system performance. Since ADS-R performance is monitored by maintenance personnel rather than ATC, report malfunctions to the nearest Flight Service Station (FSS) facility by radio or telephone. Reporters should identify:

1. Condition observed.
2. Date and time of observation.
3. Altitude and location of observation.
4. Type and call sign of the aircraft.
5. Type and software version of avionics system.

Section 6. Operational Policy/Procedures for Reduced Vertical Separation Minimum (RVSM) in the Domestic U.S., Alaska, Offshore Airspace and the San Juan FIR

4-6-1. Applicability and RVSM Mandate (Date/Time and Area)

a. Applicability. The policies, guidance and direction in this section apply to RVSM operations in the airspace over the lower 48 states, Alaska, Atlantic and Gulf of Mexico High Offshore Airspace and airspace in the San Juan FIR where VHF or UHF voice direct controller-pilot communication (DCPC) is normally available. Policies, guidance and direction for RVSM operations in oceanic airspace where VHF or UHF voice DCPC is not available and the airspace of other countries are posted on the FAA “RVSM Documentation” web page described in Paragraph 4-6-3, Aircraft and Operator Approval Policy/Procedures, RVSM Monitoring and Databases for Aircraft and Operator Approval.

b. Mandate. At 0901 UTC on January 20, 2005, the FAA implemented RVSM between flight level (FL) 290-410 (inclusive) in the following airspace: the airspace of the lower 48 states of the United States, Alaska, Atlantic and Gulf of Mexico High Offshore Airspace and the San Juan FIR. On the same time and date, RVSM was also introduced into the adjoining airspace of Canada and Mexico to provide a seamless environment for aircraft traversing those borders. In addition, RVSM was implemented on the same date in the Caribbean and South American regions.

c. RVSM Authorization. In accordance with 14 CFR Section 91.180, with only limited exceptions, prior to operating in RVSM airspace, operators and aircraft must have received RVSM authorization from the responsible civil aviation authority. (See Paragraph 4-6-10, Procedures for Accommodation of Non-RVSM Aircraft.) If the operator or aircraft or both have not been authorized for RVSM operations, the aircraft will be referred to as a “non-RVSM” aircraft. Paragraph 4-6-10 discusses ATC policies for accommodation of non-RVSM aircraft flown by the Department of Defense, Air Ambulance (MEDEVAC) operators, foreign State governments and aircraft flown for certification and development.

Paragraph 4-6-11, Non-RVSM Aircraft Requesting Climb to and Descent from Flight Levels Above RVSM Airspace Without Intermediate Level Off, contains policies for non-RVSM aircraft climbing and descending through RVSM airspace to/from flight levels above RVSM airspace.

d. Benefits. RVSM enhances ATC flexibility, mitigates conflict points, enhances sector throughput, reduces controller workload and enables crossing traffic. Operators gain fuel savings and operating efficiency benefits by flying at more fuel efficient flight levels and on more user preferred routings.

4-6-2. Flight Level Orientation Scheme

Altitude assignments for direction of flight follow a scheme of odd altitude assignment for magnetic courses 000-179 degrees and even altitudes for magnetic courses 180-359 degrees for flights up to and including FL 410, as indicated in FIG 4-6-1.

FIG 4-6-1
Flight Level Orientation Scheme

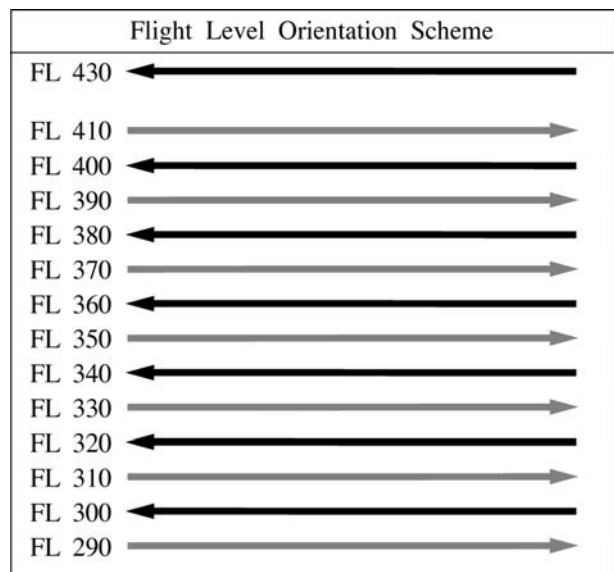

NOTE-
Odd Flight Levels: Magnetic Course 000-179 Degrees
Even Flight Levels: Magnetic Course 180-359 Degrees.

4-6-3. Aircraft and Operator Approval Policy/Procedures, RVSM Monitoring and Databases for Aircraft and Operator Approval

a. RVSM Authority. 14 CFR Section 91.180 applies to RVSM operations within the U.S. 14 CFR Section 91.706 applies to RVSM operations outside the U.S. Both sections require that the operator obtain authorization prior to operating in RVSM airspace. 14 CFR Section 91.180 requires that, prior to conducting RVSM operations within the U.S., the operator obtain authorization from the FAA or from the responsible authority, as appropriate. In addition, it requires that the operator and the operator's aircraft comply with the standards of 14 CFR Part 91 Appendix G (Operations in RVSM Airspace).

b. Sources of Information. Advisory Circular (AC) 91-85, Authorization of Aircraft and Operators for Flight in Reduced Vertical Separation Minimum (RVSM) Airspace, and the FAA RVSM website.

c. TCAS Equipage. TCAS equipage requirements are contained in 14 CFR Sections 121.356, 125.224, 129.18 and 135.189. Part 91 Appendix G does not contain TCAS equipage requirements specific to RVSM, however, Appendix G does require that aircraft equipped with TCAS II and flown in RVSM airspace be modified to incorporate TCAS II Version 7.0 or a later version.

d. Aircraft Monitoring. Operators are required to participate in the RVSM aircraft monitoring program. The "Monitoring Requirements and Procedures" section of the RVSM Documentation web page contains policies and procedures for participation in the monitoring program. Ground-based and GPS-based monitoring systems are available for the Domestic RVSM program. Monitoring is a quality control program that enables the FAA and other civil aviation authorities to assess the in-service altitude-keeping performance of aircraft and operators.

e. Purpose of RVSM Approvals Databases. ATC does not use RVSM approvals databases to determine whether or not a clearance can be issued into RVSM airspace. RVSM program managers do regularly review the operators and aircraft that operate in RVSM airspace to identify and investigate those aircraft and operators flying in RVSM airspace, but not listed on the RVSM approvals databases.

f. Registration of U.S. Operators. When U.S. operators and aircraft are granted RVSM authority, the Separation Standards Group at the FAA Technical Center obtains PTRS operator and aircraft information to update the FAA maintained U.S. Operator/Aircraft RVSM Approvals database. Basic database operator and aircraft information can be viewed on the RVSM Documentation web page in the "RVSM Approvals" section.

4-6-4. Flight Planning into RVSM Airspace

a. Operators that do not file the correct aircraft equipment suffix on the FAA or ICAO Flight Plan may be denied clearance into RVSM airspace. Policies for the FAA Flight Plan are detailed in subparagraph c below. Policies for the ICAO Flight Plan are detailed in subparagraph d.

b. The operator will annotate the equipment block of the FAA or ICAO Flight Plan with an aircraft equipment suffix indicating RVSM capability only after the responsible civil aviation authority has determined that both the operator and its aircraft are RVSM-compliant and has issued RVSM authorization to the operator.

c. General Policies for FAA Flight Plan Equipment Suffix. TBL 5-1-3, Aircraft Suffixes, allows operators to indicate that the aircraft has both RVSM and Advanced Area Navigation (RNAV) capabilities or has only RVSM capability.

1. The operator will annotate the equipment block of the FAA Flight Plan with the appropriate aircraft equipment suffix from TBL 5-1-3.

2. Operators can only file one equipment suffix in block 3 of the FAA Flight Plan. Only this equipment suffix is displayed directly to the controller.

3. Aircraft with RNAV Capability. For flight in RVSM airspace, aircraft with RNAV capability, but not Advanced RNAV capability, will file "/W". Filing "/W" will not preclude such aircraft from filing and flying direct routes in en route airspace.

d. Policy for ICAO Flight Plan Equipment Suffixes.

1. Operators/aircraft that are RVSM-compliant and that file ICAO flight plans will file "/W" in block 10 (Equipment) to indicate RVSM authorization and will also file the appropriate ICAO Flight

Plan suffixes to indicate navigation and communication capabilities. The equipment suffixes in TBL 5-1-3 are for use only in an FAA Flight Plan (FAA Form 7233-1).

2. Operators/aircraft that file ICAO flight plans that include flight in Domestic U.S. RVSM airspace must file “/W” in block 10 to indicate RVSM authorization.

e. Importance of Flight Plan Equipment Suffixes. The operator must file the appropriate equipment suffix in the equipment block of the FAA Flight Plan (FAA Form 7233-1) or the ICAO Flight Plan. The equipment suffix informs ATC:

1. Whether or not the operator and aircraft are authorized to fly in RVSM airspace.

2. The navigation and/or transponder capability of the aircraft (e.g., advanced RNAV, transponder with Mode C).

f. Significant ATC uses of the flight plan equipment suffix information are:

1. To issue or deny clearance into RVSM airspace.

2. To apply a 2,000 foot vertical separation minimum in RVSM airspace to aircraft that are not authorized for RVSM, but are in one of the limited categories that the FAA has agreed to accommodate. (See Paragraphs 4-6-10, Procedures for Accommodation of Non-RVSM Aircraft, and 4-6-11, Non-RVSM Aircraft Requesting Climb to and Descent from Flight Levels Above RVSM Airspace Without Intermediate Level Off, for policy on limited operation of unapproved aircraft in RVSM airspace).

3. To determine if the aircraft has “Advanced RNAV” capabilities and can be cleared to fly procedures for which that capability is required.

g. Improperly changing an aircraft equipment suffix and/or adding “NON-RVSM” in the NOTES or REMARKS section (Field 18) while not removing the “W” from Field 10, will not provide air traffic control with the proper visual indicator necessary to detect Non-RVSM aircraft. To ensure information processes correctly for Non-RVSM aircraft, the “W” in Field 10 must be removed. Entry of information in the NOTES or REMARKS section (Field 18) will not affect the determination of RVSM capability and must not be used to indicate a flight is Non-RVSM.

4-6-5. Pilot RVSM Operating Practices and Procedures

a. RVSM Mandate. If either the operator or the aircraft or both have not received RVSM authorization (non-RVSM aircraft), the pilot will neither request nor accept a clearance into RVSM airspace unless:

1. The flight is conducted by a non-RVSM DOD, MEDEVAC, certification/development or foreign State (government) aircraft in accordance with Paragraph 4-6-10, Procedures for Accommodation of Non-RVSM Aircraft.

2. The pilot intends to climb to or descend from FL 430 or above in accordance with Paragraph 4-6-11, Non-RVSM Aircraft Requesting Climb to and Descent from Flight Levels Above RVSM Airspace Without Intermediate Level Off.

3. An emergency situation exists.

b. Basic RVSM Operating Practices and Procedures. Appendix B of AC 91-85, *Authorization of Aircraft and Operators for Flight in Reduced Vertical Separation Minimum Airspace*, contains pilot practices and procedures for RVSM. Operators must incorporate Appendix B practices and procedures, as supplemented by the applicable paragraphs of this section, into operator training or pilot knowledge programs and operator documents containing RVSM operational policies.

c. Appendix B contains practices and procedures for flight planning, preflight procedures at the aircraft, procedures prior to RVSM airspace entry, inflight (en route) procedures, contingency procedures and post flight.

d. The following paragraphs either clarify or supplement Appendix B practices and procedures.

4-6-6. Guidance on Severe Turbulence and Mountain Wave Activity (MWA)

a. Introduction/Explanation

1. The information and practices in this paragraph are provided to emphasize to pilots and controllers the importance of taking appropriate action in RVSM airspace when aircraft experience severe turbulence and/or MWA that is of sufficient magnitude to significantly affect altitude-keeping.

2. Severe Turbulence. Severe turbulence causes large, abrupt changes in altitude and/or

attitude usually accompanied by large variations in indicated airspeed. Aircraft may be momentarily out of control. Encounters with severe turbulence must be remedied immediately in any phase of flight. Severe turbulence may be associated with MWA.

3. Mountain Wave Activity (MWA)

(a) Significant MWA occurs both below and above the floor of RVSM airspace, FL 290. MWA often occurs in western states in the vicinity of mountain ranges. It may occur when strong winds blow perpendicular to mountain ranges resulting in up and down or wave motions in the atmosphere. Wave action can produce altitude excursions and airspeed fluctuations accompanied by only light turbulence. With sufficient amplitude, however, wave action can induce altitude and airspeed fluctuations accompanied by severe turbulence. MWA is difficult to forecast and can be highly localized and short lived.

(b) Wave activity is not necessarily limited to the vicinity of mountain ranges. Pilots experiencing wave activity anywhere that significantly affects altitude—keeping can follow the guidance provided below.

(c) Inflight MWA Indicators (Including Turbulence). Indicators that the aircraft is being subjected to MWA are:

(1) Altitude excursions and/or airspeed fluctuations with or without associated turbulence.

(2) Pitch and trim changes required to maintain altitude with accompanying airspeed fluctuations.

(3) Light to severe turbulence depending on the magnitude of the MWA.

4. Priority for Controller Application of Merging Target Procedures

(a) **Explanation of Merging Target Procedures.** As described in subparagraph c3 below, ATC will use “merging target procedures” to mitigate the effects of both severe turbulence and MWA. The procedures in subparagraph c3 have been adapted from existing procedures published in FAA Order JO 7110.65, Air Traffic Control, Paragraph 5–1–8, Merging Target Procedures. Paragraph 5–1–8 calls for en route controllers to advise pilots of potential traffic that they perceive may fly directly above or below his/her aircraft at minimum vertical separa-

tion. In response, pilots are given the option of requesting a radar vector to ensure their radar target will not merge or overlap with the traffic’s radar target.

(b) The provision of “merging target procedures” to mitigate the effects of severe turbulence and/or MWA is not optional for the controller, but rather is a priority responsibility. Pilot requests for vectors for traffic avoidance when encountering MWA or pilot reports of “Unable RVSM due turbulence or MWA” are considered first priority aircraft separation and sequencing responsibilities. (FAA Order JO 7110.65, Paragraph 2–1–2, Duty Priority, states that the controller’s first priority is to separate aircraft and issue safety alerts).

(c) Explanation of the term “traffic permitting.” The contingency actions for MWA and severe turbulence detailed in Paragraph 4–6–9, Contingency Actions: Weather Encounters and Aircraft System Failures that Occur After Entry into RVSM Airspace, state that the controller will “vector aircraft to avoid merging targets with traffic at adjacent flight levels, traffic permitting.” The term “traffic permitting” is not intended to imply that merging target procedures are not a priority duty. The term is intended to recognize that, as stated in FAA Order JO 7110.65, Paragraph 2–1–2, Duty Priority, there are circumstances when the controller is required to perform more than one action and must “exercise their best judgment based on the facts and circumstances known to them” to prioritize their actions. Further direction given is: “That action which is most critical from a safety standpoint is performed first.”

5. TCAS Sensitivity. For both MWA and severe turbulence encounters in RVSM airspace, an additional concern is the sensitivity of collision avoidance systems when one or both aircraft operating in close proximity receive TCAS advisories in response to disruptions in altitude hold capability.

b. Pre-flight tools. Sources of observed and forecast information that can help the pilot ascertain the possibility of MWA or severe turbulence are: Forecast Winds and Temperatures Aloft (FD), Area Forecast (FA), Graphical Turbulence Guidance (GTG), SIGMETs and PIREPs.

c. Pilot Actions When Encountering Weather (e.g., Severe Turbulence or MWA)

1. Weather Encounters Inducing Altitude Deviations of Approximately 200 feet. When the pilot experiences weather induced altitude deviations of approximately 200 feet, the pilot will contact ATC and state “Unable RVSM Due (state reason)” (e.g., turbulence, mountain wave). See contingency actions in paragraph 4–6–9.

2. Severe Turbulence (including that associated with MWA). When pilots encounter severe turbulence, they should contact ATC and report the situation. Until the pilot reports clear of severe turbulence, the controller will apply merging target vectors to one or both passing aircraft to prevent their targets from merging:

EXAMPLE–

“Yankee 123, FL 310, unable RVSM due severe turbulence.”

“Yankee 123, fly heading 290; traffic twelve o’clock, 10 miles, opposite direction; eastbound MD–80 at FL 320” (or the controller may issue a vector to the MD–80 traffic to avoid Yankee 123).

3. MWA. When pilots encounter MWA, they should contact ATC and report the magnitude and location of the wave activity. When a controller makes a merging targets traffic call, the pilot may request a vector to avoid flying directly over or under the traffic. In situations where the pilot is experiencing altitude deviations of 200 feet or greater, the pilot will request a vector to avoid traffic. Until the pilot reports clear of MWA, the controller will apply merging target vectors to one or both passing aircraft to prevent their targets from merging:

EXAMPLE–

“Yankee 123, FL 310, unable RVSM due mountain wave.”

“Yankee 123, fly heading 290; traffic twelve o’clock, 10 miles, opposite direction; eastbound MD–80 at FL 320” (or the controller may issue a vector to the MD–80 traffic to avoid Yankee 123).

4. FL Change or Re–route. To leave airspace where MWA or severe turbulence is being encountered, the pilot may request a FL change and/or re–route, if necessary.

4–6–7. Guidance on Wake Turbulence

a. Pilots should be aware of the potential for wake turbulence encounters in RVSM airspace. Experience

gained since 1997 has shown that such encounters in RVSM airspace are generally moderate or less in magnitude.

b. Prior to DRVSM implementation, the FAA established provisions for pilots to report wake turbulence events in RVSM airspace using the NASA Aviation Safety Reporting System (ASRS). A “Safety Reporting” section established on the FAA RVSM Documentation web page provides contacts, forms, and reporting procedures.

c. To date, wake turbulence has not been reported as a significant factor in DRVSM operations. European authorities also found that reports of wake turbulence encounters did not increase significantly after RVSM implementation (eight versus seven reports in a ten–month period). In addition, they found that reported wake turbulence was generally similar to moderate clear air turbulence.

d. Pilot Action to Mitigate Wake Turbulence Encounters

1. Pilots should be alert for wake turbulence when operating:

(a) In the vicinity of aircraft climbing or descending through their altitude.

(b) Approximately 10–30 miles after passing 1,000 feet below opposite–direction traffic.

(c) Approximately 10–30 miles behind and 1,000 feet below same–direction traffic.

2. Pilots encountering or anticipating wake turbulence in DRVSM airspace have the option of requesting a vector, FL change, or if capable, a lateral offset.

NOTE–

1. *Offsets of approximately a wing span upwind generally can move the aircraft out of the immediate vicinity of another aircraft’s wake vortex.*

2. *In domestic U.S. airspace, pilots must request clearance to fly a lateral offset. Strategic lateral offsets flown in oceanic airspace do not apply.*

4–6–8. Pilot/Controller Phraseology

TBL 4–6–1 shows standard phraseology that pilots and controllers will use to communicate in DRVSM operations.

TBL 4-6-1
Pilot/Controller Phraseology

Message	Phraseology
For a controller to ascertain the RVSM approval status of an aircraft:	(call sign) confirm RVSM approved
Pilot indication that flight is RVSM approved	Affirm RVSM
Pilot report of lack of RVSM approval (non-RVSM status). Pilot will report non-RVSM status, as follows: a. On the initial call on any frequency in the RVSM airspace and . . . b. In all requests for flight level changes pertaining to flight levels within the RVSM airspace and . . . c. In all read backs to flight level clearances pertaining to flight levels within the RVSM airspace and . . . d. In read back of flight level clearances involving climb and descent through RVSM airspace (FL 290 – 410).	Negative RVSM, (supplementary information, e.g., “Certification flight”).
Pilot report of one of the following after entry into RVSM airspace: all primary altimeters, automatic altitude control systems or altitude alerters have failed. (See Paragraph 4-6-9, Contingency Actions: Weather Encounters and Aircraft System Failures that Occur After Entry into RVSM Airspace.) NOTE- <i>This phrase is to be used to convey both the initial indication of RVSM aircraft system failure and on initial contact on all frequencies in RVSM airspace until the problem ceases to exist or the aircraft has exited RVSM airspace.</i>	Unable RVSM Due Equipment
ATC denial of clearance into RVSM airspace	Unable issue clearance into RVSM airspace, maintain FL
*Pilot reporting inability to maintain cleared flight level due to weather encounter. (See Paragraph 4-6-9, Contingency Actions: Weather Encounters and Aircraft System Failures that Occur After Entry into RVSM Airspace.).	*Unable RVSM due (state reason) (e.g., turbulence, mountain wave)
ATC requesting pilot to confirm that an aircraft has regained RVSM-approved status or a pilot is ready to resume RVSM	Confirm able to resume RVSM
Pilot ready to resume RVSM after aircraft system or weather contingency	Ready to resume RVSM

4-6-9. Contingency Actions: Weather Encounters and Aircraft System Failures that Occur After Entry into RVSM Airspace

TBL 4-6-2 provides pilot guidance on actions to take under certain conditions of aircraft system

failure that occur after entry into RVSM airspace and weather encounters. It also describes the expected ATC controller actions in these situations. It is recognized that the pilot and controller will use judgment to determine the action most appropriate to any given situation.

TBL 4-6-2

Contingency Actions: Weather Encounters and Aircraft System Failures that Occur After Entry into RVSM Airspace

Initial Pilot Actions in Contingency Situations	
<p>Initial pilot actions when unable to maintain flight level (FL) or unsure of aircraft altitude-keeping capability:</p> <ul style="list-style-type: none"> •Notify ATC and request assistance as detailed below. •Maintain cleared flight level, to the extent possible, while evaluating the situation. •Watch for conflicting traffic both visually and by reference to TCAS, if equipped. •Alert nearby aircraft by illuminating exterior lights (commensurate with aircraft limitations). 	
Severe Turbulence and/or Mountain Wave Activity (MWA) Induced Altitude Deviations of Approximately 200 feet	
<p>Pilot will:</p> <ul style="list-style-type: none"> •When experiencing severe turbulence and/or MWA induced altitude deviations of approximately 200 feet or greater, pilot will contact ATC and state “Unable RVSM Due (state reason)” (e.g., turbulence, mountain wave) •If not issued by the controller, request vector clear of traffic at adjacent FLs •If desired, request FL change or re-route •Report location and magnitude of turbulence or MWA to ATC <p>See Paragraph 4-6-6, Guidance on Severe Turbulence and Mountain Wave Activity (MWA) for detailed guidance.</p>	<p>Controller will:</p> <ul style="list-style-type: none"> •Vector aircraft to avoid merging target with traffic at adjacent flight levels, traffic permitting •Advise pilot of conflicting traffic •Issue FL change or re-route, traffic permitting •Issue PIREP to other aircraft <p>Paragraph 4-6-6 explains “traffic permitting.”</p>

Mountain Wave Activity (MWA) Encounters – General	
<p>Pilot actions:</p> <ul style="list-style-type: none"> •Contact ATC and report experiencing MWA •If so desired, pilot may request a FL change or re-route •Report location and magnitude of MWA to ATC <p>See paragraph 4-6-6 for guidance on MWA.</p>	<p>Controller actions:</p> <ul style="list-style-type: none"> •Advise pilot of conflicting traffic at adjacent FL •If pilot requests, vector aircraft to avoid merging target with traffic at adjacent RVSM flight levels, traffic permitting •Issue FL change or re-route, traffic permitting •Issue PIREP to other aircraft <p>Paragraph 4-6-6 explains “traffic permitting.”</p>
<p>NOTE- <i>MWA encounters do not necessarily result in altitude deviations on the order of 200 feet. The guidance below is intended to address less significant MWA encounters.</i></p>	
Wake Turbulence Encounters	
<p>Pilot should:</p> <ul style="list-style-type: none"> •Contact ATC and request vector, FL change or, if capable, a lateral offset <p>See Paragraph 4-6-7, Guidance on Wake Turbulence.</p>	<p>Controller should:</p> <ul style="list-style-type: none"> •Issue vector, FL change or lateral offset clearance, traffic permitting <p>Paragraph 4-6-6 explains “traffic permitting.”</p>
“Unable RVSM Due Equipment” Failure of Automatic Altitude Control System, Altitude Alerter or All Primary Altimeters	
<p>Pilot will:</p> <ul style="list-style-type: none"> •Contact ATC and state “Unable RVSM Due Equipment” •Request clearance out of RVSM airspace unless operational situation dictates otherwise 	<p>Controller will:</p> <ul style="list-style-type: none"> •Provide 2,000 feet vertical separation or appropriate horizontal separation •Clear aircraft out of RVSM airspace unless operational situation dictates otherwise
One Primary Altimeter Remains Operational	
<p>Pilot will:</p> <ul style="list-style-type: none"> •Cross check stand-by altimeter •Notify ATC of operation with single primary altimeter •If unable to confirm primary altimeter accuracy, follow actions for failure of all primary altimeters 	<p>Controller will:</p> <ul style="list-style-type: none"> •Acknowledge operation with single primary altimeter

Transponder Failure	
<p>Pilot will:</p> <ul style="list-style-type: none"> •Contact ATC and request authority to continue to operate at cleared flight level •Comply with revised ATC clearance, if issued <p><i>NOTE– 14 CFR Section 91.215 (ATC transponder and altitude reporting equipment and use) regulates operation with the transponder inoperative.</i></p>	<p>Controller will:</p> <ul style="list-style-type: none"> •Consider request to continue to operate at cleared flight level •Issue revised clearance, if necessary

4–6–10. Procedures for Accommodation of Non–RVSM Aircraft

a. General Policies for Accommodation of Non–RVSM Aircraft

1. The RVSM mandate calls for only RVSM authorized aircraft/operators to fly in designated RVSM airspace with limited exceptions. The policies detailed below are intended exclusively for use by aircraft that the FAA has agreed to accommodate. They are not intended to provide other operators a means to circumvent the normal RVSM approval process.

2. If either the operator or aircraft or both have not been authorized to conduct RVSM operations, the aircraft will be referred to as a “non–RVSM” aircraft. 14 CFR Section 91.180 and Part 91 Appendix G enable the FAA to authorize a deviation to operate a non–RVSM aircraft in RVSM airspace.

3. Non–RVSM aircraft flights will be handled on a workload permitting basis. The vertical separation standard applied between aircraft not approved for RVSM and all other aircraft must be 2,000 feet.

4. **Required Pilot Calls.** The pilot of non–RVSM aircraft will inform the controller of the lack of RVSM approval in accordance with the direction provided in Paragraph 4–6–8, Pilot/Controller Phraseology.

b. Categories of Non–RVSM Aircraft that may be Accommodated

Subject to FAA approval and clearance, the following categories of non–RVSM aircraft may operate in domestic U.S. RVSM airspace provided they have an operational transponder.

1. Department of Defense (DOD) aircraft.
2. Flights conducted for aircraft certification and development purposes.
3. Active air ambulance flights utilizing a “MEDEVAC” call sign.
4. Aircraft climbing/descending through RVSM flight levels (without intermediate level off) to/from FLs above RVSM airspace (Policies for these flights are detailed in Paragraph 4–6–11, Non–RVSM Aircraft Requesting Climb to and Descent from Flight Levels Above RVSM Airspace Without Intermediate Level Off.
5. Foreign State (government) aircraft.

c. Methods for operators of non–RVSM aircraft to request access to RVSM Airspace. Operators may:

1. **LOA/MOU.** Enter into a Letter of Agreement (LOA)/Memorandum of Understanding (MOU) with the RVSM facility (the Air Traffic facility that provides air traffic services in RVSM airspace). Operators must comply with LOA/MOU.

2. **File–and–Fly.** File a flight plan to notify the FAA of their intention to request access to RVSM airspace.

*NOTE–
Priority for access to RVSM airspace will be afforded to RVSM compliant aircraft, then File–and–Fly flights.*

4-6-11. Non-RVSM Aircraft Requesting Climb to and Descent from Flight Levels Above RVSM Airspace Without Intermediate Level Off

a. File-and-Fly. Operators of Non-RVSM aircraft climbing to and descending from RVSM flight levels should just file a flight plan.

b. Non-RVSM aircraft climbing to and descending from flight levels above RVSM airspace will be handled on a workload permitting basis. The vertical separation standard applied in RVSM airspace between non-RVSM aircraft and all other aircraft must be 2,000 feet.

c. Non-RVSM aircraft climbing to/descending from RVSM airspace can only be considered for accommodation provided:

1. Aircraft is capable of a continuous climb/descent and does not need to level off at an intermediate altitude for any operational considerations and

2. Aircraft is capable of climb/descent at the normal rate for the aircraft.

d. Required Pilot Calls. The pilot of non-RVSM aircraft will inform the controller of the lack of RVSM approval in accordance with the direction provided in Paragraph 4-6-8, Pilot/Controller Phraseology.

Section 7. Operational Policy/Procedures for the Gulf of Mexico 50 NM Lateral Separation Initiative

4-7-1. Introduction and General Policies

a. Air traffic control (ATC) may apply 50 nautical mile (NM) lateral separation (i.e., lateral spacing) between airplanes authorized for Required Navigation Performance (RNP) 10 or RNP 4 operating in the Gulf of Mexico. 50 NM lateral separation may be applied in the following airspace:

1. Houston Oceanic Control Area (CTA)/Flight Information Region (FIR).

2. Gulf of Mexico portion of the Miami Oceanic CTA/FIR.

3. Monterrey CTA.

4. Merida High CTA within the Mexico FIR/UTA.

b. Within the Gulf of Mexico airspace described above, pairs of airplanes whose flight plans indicate approval for PBN and either RNP 10 or RNP 4 may be spaced by ATC at lateral intervals of 50 NM. ATC will space any airplane without RNP 10 or RNP 4 capability such that at least 90 NM lateral separation is maintained with other airplanes in the Miami Oceanic CTA, and at least 100 NM separation is maintained in the Houston, Monterrey, and Merida CTAs.

c. The reduced lateral separation allows more airplanes to fly on optimum routes/altitudes over the Gulf of Mexico.

d. 50 NM lateral separation is not applied on routes defined by ground navigation aids or on Gulf RNAV Routes Q100, Q102, or Q105.

e. Information useful for flight planning and operations over the Gulf of Mexico under this 50 NM lateral separation policy, as well as information on how to obtain RNP 10 or RNP 4 authorization, can be found in the West Atlantic Route System, Gulf of Mexico, and Caribbean Resource Guide for U.S. Operators located at:

www.faa.gov/about/office_org/headquarters_offices/avs/offices/afx/afs/afs400/afs470/media/WATRS.pdf

f. Pilots should use Strategic Lateral Offset Procedures (SLOP) in the course of regular operations within the Gulf of Mexico CTAs. SLOP procedures and limitations are published in the U.S. Aeronautical Information Publication (AIP), ENR Section 7.1, General Procedures; Advisory Circular (AC) 91-70, Oceanic and Remote Continental Airspace Operations; and ICAO Document 4444, Procedures for Air Navigation Services – Air Traffic Management.

4-7-2. Accommodating Non-RNP 10 Aircraft

a. Operators not authorized for RNP 10 or RNP 4 may still file for any route and altitude within the Gulf of Mexico CTAs. However, clearance on the operator's preferred route and/or altitude will be provided as traffic allows for 90 or 100 NM lateral separation between the non-RNP 10 aircraft and any others. Priority will be given to RNP 10 or RNP 4 aircraft.

b. Operators of aircraft not authorized RNP 10 or RNP 4 must include the annotation "RMK/NON-RNP10" in Item 18 of their ATC flight plan.

c. Pilots of non-RNP 10 aircraft are to remind ATC of their RNP status; i.e., report "negative RNP 10" upon initial contact with ATC in each Gulf CTA.

d. Operators will likely benefit from the effort they invest to obtain RNP 10 or RNP 4 authorization, provided they are flying aircraft equipped to meet RNP 10 or RNP 4 standards.

4-7-3. Obtaining RNP 10 or RNP 4 Operational Authorization

a. For U.S. operators, AC 90-105, Approval Guidance for RNP Operations and Barometric Vertical Navigation in the U.S. National Airspace System and in Oceanic and Remote Continental Airspace, provides the aircraft and operator qualification criteria for RNP 10 or RNP 4 authorizations. FAA personnel at flight standards district offices (FSDO) and certificate management offices (CMO) will use the guidance contained in

AC 90–105 to evaluate an operator’s application for RNP 10 or RNP 4 authorization. Authorization to conduct RNP operations in oceanic airspace is provided to all U.S. operators through issuance of Operations Specification (OpSpec), Management Specification (MSpec), or Letter of Authorization (LOA) B036, as applicable to the nature of the operation; for example, Part 121, Part 91, etc. Operators may wish to review FAA Order 8900.1, Flight Standards Information Management System, volume 3, chapter 18, section 4, to understand the specific criteria for issuing OpSpec, MSpec, and/or LOA B036.

b. The operator’s RNP 10 or RNP 4 authorization should include any equipment requirements and RNP 10 time limits (if operating solely inertial-based navigation systems), which must be observed when conducting RNP operations. RNP 4 requires tighter navigation and track maintenance accuracy than RNP 10.

4–7–4. Authority for Operations with a Single Long-Range Navigation System

Operators may be authorized to take advantage of 50 NM lateral separation in the Gulf of Mexico CTAs when equipped with only a single long-range navigation system. RNP 10 with a single long-range navigation system is authorized via OpSpec, MSpec, or LOA B054. Operators should contact their FSDO or CMO to obtain information on the specific requirements for obtaining B054. Volume 3, chapter 18, section 4 of FAA Order 8900.1 provides the qualification criteria to be used by FAA aviation safety inspectors in issuing B054.

4–7–5. Flight Plan Requirements

a. In order for an operator with RNP 10 or RNP 4 authorization to obtain 50 NM lateral separation in

the Gulf of Mexico CTAs, and therefore obtain preferred routing available to RNP authorized aircraft, the international flight plan form (FAA 7233–4) must be annotated as follows:

1. Item 10a (Equipment) must include the letter “R.”

2. Item 18 must include either “PBN/A1” for RNP 10 authorization or “PBN/L1” for RNP 4 authorization.

b. Indication of RNP 4 authorization implies the aircraft and pilots are also authorized RNP 10.

c. Chapter 5, section 1, of this manual includes information on all flight plan codes. RNP 10 has the same meaning and application as RNAV 10. They share the same code.

4–7–6. Contingency Procedures

Pilots operating under reduced lateral separation must be particularly familiar with, and prepared to rapidly implement, the standard contingency procedures specifically written for operations when outside ATC surveillance and direct VHF communications (for example, the oceanic environment). Specific procedures have been developed for weather deviations. Operators should ensure all flight crews operating in this type of environment have been provided the standard contingency procedures in a readily accessible format. The margin for error when operating at reduced separation mandates correct and expeditious application of the standard contingency procedures. These internationally accepted procedures are published in ICAO Document 4444, chapter 15. The procedures are also reprinted in the U.S. Aeronautical Information Publication (AIP), En Route (ENR) Section 7.3, Special Procedures for In-flight Contingencies in Oceanic Airspace; and AC 91–70.

Chapter 5. Air Traffic Procedures

Section 1. Preflight

5-1-1. Preflight Preparation

a. Every pilot is urged to receive a preflight briefing and to file a flight plan. This briefing should consist of the latest or most current weather, airport, and en route NAVAID information. Briefing service may be obtained from an FSS either by telephone or radio when airborne. Pilots within the contiguous U.S. may access Flight Service through **www.1800wxbrief.com** or by contacting them at 1-800-WX-Brief to obtain preflight weather data and to file IFR and VFR flight plans.

NOTE-

Pilots filing flight plans via “fast file” who desire to have their briefing recorded, should include a statement at the end of the recording as to the source of their weather briefing.

b. The information required by the FAA to process flight plans is contained on FAA Form 7233-1, Flight Plan, or FAA Form 7233-4, International Flight Plan. The forms are available at all flight service stations. Additional copies will be provided on request.

REFERENCE-

AIM, Paragraph 5-1-4, Flight Plan- VFR Flights

AIM, Paragraph 5-1-8, Flight Plan- IFR Flights

AIM, Paragraph 5-1-9, International Flight Plan- IFR Flights

c. Consult an FSS for preflight weather briefing.

d. FSSs are required to advise of pertinent NOTAMs if a *standard* briefing is requested, but if they are overlooked, do not hesitate to remind the specialist that you have not received NOTAM information.

NOTE-

NOTAMs, graphic notices, and other information published in the Notices to Airmen Publication (NTAP) are not provided during a briefing unless specifically requested by the pilot since the FSS specialist has no way of knowing whether the pilot has already checked the NTAP prior to calling. Airway NOTAMs, procedural NOTAMs, and NOTAMs that are general in nature and not tied to a specific airport/facility (for example, flight advisories and restrictions, open duration special security instructions, and special flight rules areas) are briefed solely by pilot request. Remember to ask for NOTAMs and graphic notices published in the NTAP if you have not already reviewed this

information, and to request all pertinent NOTAMs specific to your flight.

REFERENCE-

AIM, Paragraph 5-1-3, Notice to Airmen (NOTAM) System

e. Pilots are urged to use only the latest issue of aeronautical charts in planning and conducting flight operations. Aeronautical charts are revised and reissued on a regular scheduled basis to ensure that depicted data are current and reliable. In the conterminous U.S., Sectional Charts are updated every 6 months, IFR En Route Charts every 56 days, and amendments to civil IFR Approach Charts are accomplished on a 56-day cycle with a change notice volume issued on the 28-day midcycle. Charts that have been superseded by those of a more recent date may contain obsolete or incomplete flight information.

REFERENCE-

AIM, Paragraph 9-1-4, General Description of Each Chart Series

f. When requesting a preflight briefing, identify yourself as a pilot and provide the following:

1. Type of flight planned; e.g., VFR or IFR.
2. Aircraft's number or pilot's name.
3. Aircraft type.
4. Departure Airport.
5. Route of flight.
6. Destination.
7. Flight altitude(s).
8. ETD and ETE.

g. Prior to conducting a briefing, briefers are required to have the background information listed above so that they may tailor the briefing to the needs of the proposed flight. The objective is to communicate a “picture” of meteorological and aeronautical information necessary for the conduct of a safe and efficient flight. Briefers use all available weather and aeronautical information to summarize data applicable to the proposed flight. They do not read weather reports and forecasts verbatim unless specifically requested by the pilot. FSS briefers do not provide FDC NOTAM information for special

instrument approach procedures unless specifically asked. Pilots authorized by the FAA to use special instrument approach procedures must specifically request FDC NOTAM information for these procedures. Pilots who receive the information electronically will receive NOTAMs for special IAPs automatically.

REFERENCE-

AIM, Paragraph 7-1-5, Preflight Briefings, contains those items of a weather briefing that should be expected or requested.

h. FAA by 14 CFR Part 93, Subpart K, has designated High Density Traffic Airports (HDTA) and has prescribed air traffic rules and requirements for operating aircraft (excluding helicopter operations) to and from these airports.

REFERENCE-

*Chart Supplement U.S., Special Notices Section
AIM, Paragraph 4-1-21, Airport Reservation Operations and Special Traffic Management Programs*

i. In addition to the filing of a flight plan, if the flight will traverse or land in one or more foreign countries, it is particularly important that pilots leave a complete itinerary with someone directly concerned and keep that person advised of the flight's progress. If serious doubt arises as to the safety of the flight, that person should first contact the FSS.

REFERENCE-

AIM, Paragraph 5-1-11, Flights Outside the U.S. and U.S. Territories

j. Pilots operating under provisions of 14 CFR Part 135 on a domestic flight without having an FAA assigned 3-letter designator, must prefix the normal registration (N) number with the letter "T" on flight plan filing; for example, TN1234B.

REFERENCE-

*AIM, Paragraph 4-2-4, Aircraft Call Signs
FAA Order JO 7110.65, Paragraph 2-3-5a, Aircraft Identity
FAA Order JO 7110.10, Paragraph 6-2-1b1, Flight Plan Recording*

5-1-2. Follow IFR Procedures Even When Operating VFR

a. To maintain IFR proficiency, pilots are urged to practice IFR procedures whenever possible, even when operating VFR. Some suggested practices include:

1. Obtain a complete preflight and weather briefing. Check the NOTAMs.

2. File a flight plan. This is an excellent low cost insurance policy. The cost is the time it takes to fill it out. The insurance includes the knowledge that

someone will be looking for you if you become overdue at your destination.

3. Use current charts.

4. Use the navigation aids. Practice maintaining a good course—keep the needle centered.

5. Maintain a constant altitude which is appropriate for the direction of flight.

6. Estimate en route position times.

7. Make accurate and frequent position reports to the FSSs along your route of flight.

b. Simulated IFR flight is recommended (under the hood); however, pilots are cautioned to review and adhere to the requirements specified in 14 CFR Section 91.109 before and during such flight.

c. When flying VFR at night, in addition to the altitude appropriate for the direction of flight, pilots should maintain an altitude which is at or above the minimum en route altitude as shown on charts. This is especially true in mountainous terrain, where there is usually very little ground reference. Do not depend on your eyes alone to avoid rising unlighted terrain, or even lighted obstructions such as TV towers.

5-1-3. Notice to Airmen (NOTAM) System

a. Time-critical aeronautical information which is of either a temporary nature or not sufficiently known in advance to permit publication on aeronautical charts or in other operational publications receives immediate dissemination via the National NOTAM System.

NOTE-

1. NOTAM information is that aeronautical information that could affect a pilot's decision to make a flight. It includes such information as airport or aerodrome primary runway closures, taxiways, ramps, obstructions, communications, airspace, changes in the status of navigational aids, ILSs, radar service availability, and other information essential to planned en route, terminal, or landing operations.

2. NOTAM information is transmitted using standard contractions to reduce transmission time. See TBL 5-1-2 for a listing of the most commonly used contractions. For a complete listing, see FAA JO Order 7340.2, Contractions.

b. NOTAM information is classified into five categories. These are NOTAM (D) or distant, Flight Data Center (FDC) NOTAMs, Pointer NOTAMs,

Special Activity Airspace (SAA) NOTAMs, and Military NOTAMs.

1. NOTAM (D) information is disseminated for all navigational facilities that are part of the National Airspace System (NAS), all public use airports, seaplane bases, and heliports listed in the Chart Supplement U.S. The complete file of all NOTAM (D) information is maintained in a computer database at the Weather Message Switching Center (WMSC), located in Atlanta, Georgia. This category of information is distributed automatically via Service A telecommunications system. Air traffic facilities, primarily FSSs, with Service A capability have access to the entire WMSC database of NOTAMs. These NOTAMs remain available via Service A for the duration of their validity or until published. Once published, the NOTAM data is deleted from the system. NOTAM (D) information includes such data as taxiway closures, personnel and equipment near or crossing runways, and airport lighting aids that do not affect instrument approach criteria, such as VASI.

All NOTAM Ds must have one of the keywords listed in TBL 5-1-1 as the first part of the text after the location identifier.

2. FDC NOTAMs. On those occasions when it becomes necessary to disseminate information which is regulatory in nature, the National Flight Data Center (NFDC), in Washington, DC, will issue an FDC NOTAM. FDC NOTAMs contain such things as amendments to published IAPs and other current aeronautical charts. They are also used to advertise temporary flight restrictions caused by such things as natural disasters or large-scale public events that may generate a congestion of air traffic over a site.

NOTE-

NOTAM data may not always be current due to the changeable nature of national airspace system components, delays inherent in processing information, and occasional temporary outages of the U.S. NOTAM system. While en route, pilots should contact FSSs and obtain updated information for their route of flight and destination.

3. Pointer NOTAMs. NOTAMs issued by a flight service station to highlight or point out another NOTAM, such as an FDC or NOTAM (D) NOTAM. This type of NOTAM will assist users in cross-referencing important information that may

not be found under an airport or NAVAID identifier. Keywords in pointer NOTAMs must match the keywords in the NOTAM that is being pointed out. The keyword in pointer NOTAMs related to Temporary Flight Restrictions (TFR) must be AIRSPACE.

4. SAA NOTAMs. These NOTAMs are issued when Special Activity Airspace will be active outside the published schedule times and when required by the published schedule. Pilots and other users are still responsible to check published schedule times for Special Activity Airspace as well as any NOTAMs for that airspace.

5. Military NOTAMs. NOTAMs pertaining to U.S. Air Force, Army, Marine, and Navy navigational aids/airports that are part of the NAS.

c. Notices to Airmen Publication (NTAP). The NTAP is published by Mission Support Services, ATC Products and Publications, every 28 days. Data of a permanent nature can be published in the NTAP as an interim step between publication cycles of the Chart Supplement U.S. and aeronautical charts. The NTAP is divided into three parts:

1. Part 1, provided by NFDC, contains Part 95 Revisions, Revisions to Minimum En Route IFR Altitudes and Changeover Points.

2. Part 2, International NOTAMs, is divided into two sections:

(a) Section 1, International Flight Prohibitions, Potential Hostile Situations, and Foreign Notices.

(b) Section 2, International Oceanic Airspace Notices.

3. Part 3, Graphic Notices, compiled by ATC Products and Publications from data provided by FAA service area offices and other lines of business, contains special notices and graphics pertaining to almost every aspect of aviation such as: military training areas, large scale sporting events, air show information, Special Traffic Management Programs (STMP), and airport-specific information. This part is comprised of 6 sections: General, Special Military Operations, Airport and Facility Notices, Major Sporting and Entertainment Events, Airshows, and Special Notices.

TBL 5-1-1
NOTAM Keywords

Keyword	Definition
RWY <i>Example</i>	Runway !BNA BNA RWY 36 CLSD 1309131300-1309132000EST
TWY <i>Example</i>	Taxiway !BTV BTV TWY C EDGE LGT OBSC 1310131300-1310141300EST
APRON <i>Example</i>	Apron/Ramp !BNA BNA APRON NORTH APRON EAST SIDE CLSD 13111221500-1312220700
AD <i>Example</i>	Aerodrome !BET BET AD ELK NEAR MVMT AREAS 1309251300-1309262200EST
OBST <i>Example</i>	Obstruction !SJT SJT OBST MOORED BALLOON WITHIN AREA DEFINED AS 1NM RADIUS OF SJT 2430FT (510FT AGL) FLAGGED 1309251400-1309261400EST
NAV <i>Example</i>	Navigation Aids !SHV SHV NAV ILS RWY 32 110.3 COMMISSIONED 1311251600-PERM
COM <i>Example</i>	Communications !INW INW COM REMOTE COM OUTLET 122.6 OUT OF SERVICE 1307121330-1307151930EST
SVC <i>Example</i>	Services !ROA ROA SVC TWR COMMISSIONED 1301050001-PERM
AIRSPACE .. <i>Example</i>	Airspace !MIV MIV AIRSPACE AIRSHOW ACFT WITHIN AREA DEFINED AS 5NM RADIUS OF MIV SFC-10000FT AVOIDANCE ADVISED 1308122100-1308122300
ODP <i>Example</i>	Obstacle Departure Procedure !FDC 2/9700 DIK ODP DICKINSON - THEODORE ROOSEVELT RGNL, DICKINSON, ND. TAKEOFF MINIMUMS AND (OBSTACLE) DEPARTURE PROCEDURES AMDT 1... DEPARTURE PROCEDURE: RWY 25, CLIMB HEADING 250 TO 3500 BEFORE TURNING LEFT. ALL OTHER DATA REMAINS AS PUBLISHED. THIS IS TAKEOFF MINIMUMS AND (OBSTACLE) DEPARTURE PROCEDURES, AMDT 1A. 1305011200-PERM
SID <i>Example</i>	Standard Instrument Departure !FDC x/xxxx DFW SID DALLAS/FORT WORTH INTL, DALLAS, TX. PODDE THREE DEPARTURE... CHANGE NOTES TO READ: RWYS 17C/R, 18L/R: DO NOT EXCEED 240KT UNTIL LARRN. RWYS 35L/C, 36L/R: DONOT EXCEED 240KT UNTIL KMART 1305011200-1312111200EST
STAR <i>Example</i>	Standard Terminal Arrival !FDC x/xxxx DCA STAR RONALD REAGAN WASHINGTON NATIONAL, WASHINGTON, DC. WZRRD TWO ARRIVAL... SHAAR TRANSITION: ROUTE FROM DRUZZ INT TO WZRRD INT NOT AUTHORIZED. AFTER DRUZZ INT EXPECT RADAR VECTORS TO AML VORTAC 1305011200-1312111200ES

Keyword	Definition
CHART <i>Example</i>	Chart !FDC 2/9997 DAL IAP DALLAS LOVE FIELD, DALLAS, TX. ILS OR LOC RWY 31R, AMDT 5... CHART NOTE: SIMULTANEOUS APPROACH AUTHORIZED WITH RWY 31L. MISSED APPROACH: CLIMB TO 1000 THEN CLIMBING RIGHT TURN TO 5000 ON HEADING 330 AND CVE R-046 TO FINGR INT/CVE 36.4 DME AND HOLD. CHART LOC RWY 31L. THIS IS ILS OR LOC RWY 31R, AMDT 5A. 1305011200-PERM
DATA <i>Example</i>	Data !FDC 2/9700 DIK ODP DICKINSON - THEODORE ROOSEVELT RGNL, DICKINSON, ND. TAKEOFF MINIMUMS AND (OBSTACLE) DEPARTURE PROCEDURES AMDT 1... DEPARTURE PROCEDURE: RWY 25, CLIMB HEADING 250 TO 3500 BEFORE TURNING LEFT. ALL OTHER DATA REMAINS AS PUBLISHED. THIS IS TAKEOFF MINIMUMS AND (OBSTACLE) DEPARTURE PROCEDURES, AMDT 1A. 1305011200-PERM
IAP <i>Example</i>	Instrument Approach Procedure !FDC 2/9997 DAL IAP DALLAS LOVE FIELD, DALLAS, TX. ILS OR LOC RWY 31R, AMDT 5... CHART NOTE: SIMULTANEOUS APPROACH AUTHORIZED WITH RWY 31L. MISSED APPROACH: CLIMB TO 1000 THEN CLIMBING RIGHT TURN TO 5000 ON HEADING 330 AND CVE R-046 TO FINGR INT/CVE 36.4 DME AND HOLD. CHART LOC RWY 31L. THIS IS ILS OR LOC RWY 31R, AMDT 5A. 1305011200-PERM
VFP <i>Example</i>	Visual Flight Procedures !FDC X/XXXX JFK VFP JOHN F KENNEDY INTL, NEW YORK, NY. PARKWAY VISUAL RWY 13L/R, ORIG...WEATHER MINIMUMS 3000 FOOT CEILING AND 3 MILES VISIBILITY. 1303011200-1308011400EST
ROUTE <i>Example</i>	Route !FDC x/xxxx ZFW OK..ROUTE ZFW ZKC. V140 SAYRE (SYO) VORTAC, OK TO TULSA (TUL) VORTAC, OK MEA 4300. 1305041000-1306302359EST
SPECIAL ... <i>Example</i>	Special !FDC x/xxxx PAJN SPECIAL JUNEAU INTERNATIONAL, JUNEAU, AK. LDA-2 RWY 8 AMDT 9 PROCEDURE TURN NA. 1305011200-1312111200EST
SECURITY .. <i>Example</i>	Security !FDC ZZZ SECURITY..SPECIAL NOTICE..THIS NOTICE IS TO EMPHASIZE THAT BEFORE OPERATING IN OR ADJACENT TO IRANIAN AIRSPACE ALL U.S. AIRMEN AND OPERATORS SHOULD BE FAMILIAR WITH CURRENT CONDITIONS IN THE MIDDLE EAST. THE U.S. DEPART- MENT OF STATE HAS ISSUED A TRAVEL WARNING FOR IRAN ADVISING, IN PART, THAT THE U.S. GOVERNMENT DOES NOT CURRENTLY MAINTAIN DIPLOMATIC OR CONSULAR RELATIONS WITH THE ISLAMIC REPUBLIC OF IRAN. ANY U.S. OPERATOR PLANNING A FLIGHT THROUGH IRANIAN AIRSPACE SHOULD PLAN IN ADVANCE AND HAVE ALL CURRENT NOTAMS AND AERONAUTICAL INFORMATION FOR ANY PLANNED FLIGHT 1311011200-1403301800EST
U	Unverified Aeronautical Information (for use only where authorized by Letter of Agreement)*
O	Other Aeronautical Information**

NOTE-

1. * Unverified Aeronautical Information can be movement area or other information received that meets NOTAM criteria and has not been confirmed by the Airport Manager (AMGR) or their designee. If Flight Service is unable to contact airport management, Flight Service must forward (U) NOTAM information to the United States NOTAM System (USNS). Subsequent to USNS distribution of a (U) NOTAM, Flight Service will inform airport management of the action taken as soon as practical. Any such NOTAM will be prefaced with “(U)” as the keyword and followed by the appropriate keyword contraction, following the location identifier.

2. ** Other Aeronautical Information is that which is received from any authorized source that may be beneficial to aircraft operations and does not meet defined NOTAM criteria. Any such NOTAM will be prefaced with “(O)” as the keyword following the location identifier.

TBL 5-1-2

Contractions Commonly Found in NOTAMS

A	
ABN	Aerodrome Beacon
ABV	Above
ACFT	Aircraft
ACT	Active
ADJ	Adjacent
AGL	Above Ground Level
ALS	Approach Light System
ALT	Altitude
ALTN/ALTNLY .	Alternate/Alternately
AMDT	Amendment
APCH	Approach
ARFF	Aircraft Rescue & Fire Fighting
ASDA	Accelerate Stop Distance Available
ASOS	Automated Surface Observing System
ASPH	Asphalt
ATC	Air Traffic Control
ATIS	Automated Terminal Information Service
AVBL	Available
AWOS	Automatic Weather Observing System
AZM	Azimuth
B	
BTN	Between
C	
CAT	Category
CH	Channel
CL	Centerline
CLSD	Closed
COM	Communication
CONC	Concrete
CONT	Continue/Continuously
CTL	Control
D	
DCT	Direct
DEP	Depart/Departure
DH	Decision Height
DLA/DLAD	Delay/Delayed
DME	Distance Measuring Equipment
DWPNT	Dew Point Temperature
E	
E	East
EB	Eastbound
ELEV	Elevate/Elevation
ENG	Engine
EST	Estimated
EXC	Except
F	
FAC	Facility
FAF	Final Approach Fix
FDC	Flight Data Center
FICON	Field Condition
FREQ	Frequency
FSS	Flight Service Station

FT	Feet
G	
GCA	Ground Controlled Approach
GP	Glide Path
GPS	Global Positioning System
GRVL	Gravel
H	
HEL	Helicopter
HIRL	High Intensity Runway Lights
HR	Hour
I	
ID	Identify/Identifier
IFR	Instrument Flight Rules
ILS	Instrument Landing System
IM	Inner Marker
IN	Inch/Inches
INOP	Inoperative
INST	Instrument
INT	Intersection
INTST	Intensity
L	
L	Left
LB	Pound/Pounds
LDA	Landing Distance Available
LDG	Landing
LGT/LGTD	Light/Lighted
LIRL	Low Intensity Runway Edge Lights
LNDG	Landing
LOC	Localizer
M	
MALS	Medium Intensity Approach Lighting System
MALSF	Medium Intensity Approach Lighting System with Sequenced Flashers
MALSRL	Medium Intensity Approach Lighting System with Runway Alignment Indicator Lights
MCA	Minimum Crossing Altitude
MDA	Minimum Descent Altitude
MEA	Minimum En Route Altitude
MIRL	Medium Intensity Runway Edge Lights
MKR	Marker
MM	Middle Marker
MNM	Minimum
MOA	Military Operations Area
MOCA	Minimum Obstruction Clearance Altitude
MSG	Message
MSL	Mean Sea Level
MU	Designate a Friction Value Representing Runway Surface Conditions
N	
N	North
NDB	Nondirectional Radio Beacon
NE	Northeast
NM	Nautical Mile/s
NTAP	Notice To Airmen Publication

NW	Northwest
O	
OBSC	Obscured
OM	Outer Marker
OPR	Operate
ORIG	Original
P	
PAPI	Precision Approach Path Indicator
PARL	Parallel
PAX	Passenger/s
PCL	Pilot Controlled Lighting
PERM	Permanent
PJE	Parachute Jumping Activities
PLA	Practice Low Approach
PN	Prior Notice Required
PPR	Prior Permission Required
PT	Procedure Turn
R	
RAI	Runway Alignment Indicator
RCL	Runway Centerline
RCLL	Runway Centerline Light
REC	Receive/Receiver
RLLS	Runway Lead-in Light System
RNAV	Area Navigation
RVR	Runway Visual Range
RVRM	RVR Midpoint
RVRR	RVR Rollout
RVRT	RVR Touchdown
RWY	Runway
S	
S	South
SAA	Special Activity Airspace
SE	Southeast
SFC	Surface
SKED	Scheduled
SN	Snow
SR	Sunrise
SS	Sunset
SSALF	Simplified Short Approach Lighting System with Sequenced Flashers
SSALR	Simplified Short Approach Lighting System with Runway Alignment Indicator Lights
SSALS	Simplified Short Approach Lighting System
STAR	Standard Terminal Arrival
STD	Standard
SW	Southwest
T	
TACAN	Tactical Air Navigational Aid
TDZ	Touchdown Zone
TEMPO	Temporary
TFC	Traffic
TFR	Temporary Flight Restriction
TGL	Touch and Go Landings
THR	Threshold
TKOF	Takeoff

TODA	Take-off Distance Available
TORA	Take-off Run Available
TWR	Aerodrome Control Tower
TWY	Taxiway
U	
UNL	Unlimited
UNREL	Unreliable
V	
VASI	Visual Approach Slope Indicator
VFR	Visual Flight Rules
VHF	Very High Frequency
VIS	Visibility
VMC	Visual Meteorological Conditions
VOLMET	Meteorological Information for Aircraft in Flight
VOR	VHF Omni-Directional Radio Range
VORTAC	VOR and TACAN (collocated)
VOT	VOR Test Facility
W	
W	West
WAAS	Wide Area Augmentation System
WDI	Wind Direction Indicator
WPT	Waypoint
WX	Weather

5-1-4. Flight Plan – VFR Flights

a. Except for operations in or penetrating an ADIZ, a flight plan is not required for VFR flight.

REFERENCE-

AIM, Chapter 5, Section 6, National Security and Interception Procedures

b. It is strongly recommended that a flight plan (for a VFR flight) be filed with an FAA FSS. This will ensure that you receive VFR Search and Rescue Protection.

REFERENCE-

AIM, Paragraph 6-2-6, Search and Rescue, gives the proper method of filing a VFR flight plan.

c. To obtain maximum benefits from the flight plan program, flight plans should be filed directly with the nearest FSS. For your convenience, FSSs provide aeronautical and meteorological briefings while accepting flight plans. Radio may be used to file if no other means are available.

NOTE-

Some states operate aeronautical communications facilities which will accept and forward flight plans to the FSS for further handling.

d. When a “stopover” flight is anticipated, it is recommended that a separate flight plan be filed for each “leg” when the stop is expected to be more than 1 hour duration.

e. Pilots are encouraged to give their departure times directly to the FSS serving the departure airport or as otherwise indicated by the FSS when the flight plan is filed. This will ensure more efficient flight plan service and permit the FSS to advise you of significant changes in aeronautical facilities or meteorological conditions. When a VFR flight plan is filed, it will be held by the FSS until 1 hour after the proposed departure time unless:

1. The actual departure time is received.
2. A revised proposed departure time is received.
3. At a time of filing, the FSS is informed that the proposed departure time will be met, but actual time cannot be given because of inadequate communications (assumed departures).

f. On pilot's request, at a location having an active tower, the aircraft identification will be forwarded by the tower to the FSS for reporting the actual departure time. This procedure should be avoided at busy airports.

g. Although position reports are not required for VFR flight plans, periodic reports to FAA FSSs along the route are good practice. Such contacts permit

significant information to be passed to the transiting aircraft and also serve to check the progress of the flight should it be necessary for any reason to locate the aircraft.

EXAMPLE-

1. *Bonanza 314K, over Kingfisher at (time), VFR flight plan, Tulsa to Amarillo.*

2. *Cherokee 5133J, over Oklahoma City at (time), Shreveport to Denver, no flight plan.*

h. Pilots not operating on an IFR flight plan and when in level cruising flight, are cautioned to conform with VFR cruising altitudes appropriate to the direction of flight.

i. When filing VFR flight plans, indicate aircraft equipment capabilities by appending the appropriate suffix to aircraft type in the same manner as that prescribed for IFR flight.

REFERENCE-

AIM, Paragraph 5-1-8, Flight Plan- Domestic IFR Flights

j. Under some circumstances, ATC computer tapes can be useful in constructing the radar history of a downed or crashed aircraft. In each case, knowledge of the aircraft's transponder equipment is necessary in determining whether or not such computer tapes might prove effective.

FIG 5-1-1
FAA Flight Plan
Form 7233-1 (8-82)

U.S. DEPARTMENT OF TRANSPORTATION FEDERAL AVIATION ADMINISTRATION		(FAA USE ONLY) <input type="checkbox"/> PILOT BRIEFING <input type="checkbox"/> VNR			TIME STARTED	SPECIALIST INITIALS
FLIGHT PLAN		<input type="checkbox"/> STOPOVER				
1. TYPE	2. AIRCRAFT IDENTIFICATION	3. AIRCRAFT TYPE/SPECIAL EQUIPMENT	4. TRUE AIRSPEED	5. DEPARTURE POINT	6. DEPARTURE TIME	
VFR IFR DVFR			KTS		PROPOSED (Z) ACTUAL (Z)	7. CRUISING ALTITUDE
8. ROUTE OF FLIGHT						
9. DESTINATION (Name of airport and city)		10. EST. TIME ENROUTE		11. REMARKS		
		HOURS	MINUTES			
12. FUEL ON BOARD		13. ALTERNATE AIRPORT(S)		14. PILOT'S NAME, ADDRESS & TELEPHONE NUMBER & AIRCRAFT HOME BASE		15. NUMBER ABOARD
HOURS	MINUTES					
16. COLOR OF AIRCRAFT		<small>CIVIL AIRCRAFT PILOTS, FAR 91 requires you file an IFR flight plan to operate under instrument flight rules in controlled airspace. Failure to file could result in a civil penalty not to exceed \$1,000 for each violation (Section 901 of the Federal Aviation Act of 1958, as amended). Filing of a VFR flight plan is recommended as a good operating practice. See also Part 99 for requirements concerning DVFR flight plans.</small>				

FAA Form 7233-1 (8-82) **CLOSE VFR FLIGHT PLAN WITH _____ FSS ON ARRIVAL**

k. Flight Plan Form – (See FIG 5-1-1).

l. Explanation of VFR Flight Plan Items.

1. Block 1. Check the type flight plan. Check both the VFR and IFR blocks if composite VFR/IFR.

2. Block 2. Enter your complete aircraft identification including the prefix “N” if applicable.

3. Block 3. Enter the designator for the aircraft, or if unknown, consult an FSS briefer.

4. Block 4. Enter your true airspeed (TAS).

5. Block 5. Enter the departure airport identifier code, or if unknown, the name of the airport.

6. Block 6. Enter the proposed departure time in Coordinated Universal Time (UTC) (Z). If airborne, specify the actual or proposed departure time as appropriate.

7. Block 7. Enter the appropriate VFR altitude (to assist the briefer in providing weather and wind information).

8. Block 8. Define the route of flight by using NAVAID identifier codes and airways.

9. Block 9. Enter the destination airport identifier code, or if unknown, the airport name.

NOTE–
Include the city name (or even the state name) if needed for clarity.

10. Block 10. Enter your estimated time en route in hours and minutes.

11. Block 11. Enter only those remarks that may aid in VFR search and rescue, such as planned stops en route or student cross country, or remarks pertinent to the clarification of other flight plan information, such as the radiotelephony (call sign) associated with a designator filed in Block 2, if the radiotelephony is new, has changed within the last 60 days, or is a special FAA-assigned temporary radiotelephony. Items of a personal nature are not accepted.

12. Block 12. Specify the fuel on board in hours and minutes.

13. Block 13. Specify an alternate airport if desired.

14. Block 14. Enter your complete name, address, and telephone number. Enter sufficient information to identify home base, airport, or operator.

NOTE–

This information is essential in the event of search and rescue operations.

15. Block 15. Enter total number of persons on board (POB) including crew.

16. Block 16. Enter the predominant colors.

17. Block 17. Record the FSS name for closing the flight plan. If the flight plan is closed with a different FSS or facility, state the recorded FSS name that would normally have closed your flight plan.

NOTE–

1. Optional– record a destination telephone number to assist search and rescue contact should you fail to report or cancel your flight plan within 1/2 hour after your estimated time of arrival (ETA).

2. The information transmitted to the destination FSS will consist only of flight plan blocks 2, 3, 9, and 10. Estimated time en route (ETE) will be converted to the correct ETA.

5–1–5. Operational Information System (OIS)

a. The FAA’s Air Traffic Control System Command Center (ATCSCC) maintains a website with near real–time National Airspace System (NAS) status information. NAS operators are encouraged to access the website at <http://www.fly.faa.gov> prior to filing their flight plan.

b. The website consolidates information from advisories. An advisory is a message that is disseminated electronically by the ATCSCC that contains information pertinent to the NAS.

1. Advisories are normally issued for the following items:

- (a) Ground Stops.
- (b) Ground Delay Programs.

(c) Route Information.

(d) Plan of Operations.

(e) Facility Outages and Scheduled Facility Outages.

(f) Volcanic Ash Activity Bulletins.

(g) Special Traffic Management Programs.

2. This list is not all–inclusive. Any time there is information that may be beneficial to a large number of people, an advisory may be sent. Additionally, there may be times when an advisory is not sent due to workload or the short length of time of the activity.

3. Route information is available on the website and in specific advisories. Some route information, subject to the 56–day publishing cycle, is located on the “OIS” under “Products,” Route Management Tool (RMT), and “What’s New” Playbook. The RMT and Playbook contain routings for use by Air Traffic and NAS operators when they are coordinated “real–time” and are then published in an ATCSCC advisory.

4. Route advisories are identified by the word “Route” in the header; the associated action is required (RQD), recommended (RMD), planned (PLN), or for your information (FYI). Operators are expected to file flight plans consistent with the Route RQD advisories.

5. Electronic System Impact Reports are on the intranet at <http://www.atcsc.faa.gov/ois/> under “System Impact Reports.” This page lists scheduled outages/events/projects that significantly impact the NAS; for example, runway closures, air shows, and construction projects. Information includes anticipated delays and traffic management initiatives (TMI) that may be implemented.

5–1–6. Flight Plan– Defense VFR (DVFR) Flights

VFR flights (except DOD or law enforcement flights) into an ADIZ are required to file DVFR flight plans for security purposes. Detailed ADIZ procedures are found in Section 6, National Security and Interception Procedures, of this chapter. (See 14 CFR Part 99, Security Control of Air Traffic)

5-1-7. Composite Flight Plan (VFR/IFR Flights)

a. Flight plans which specify VFR operation for one portion of a flight, and IFR for another portion, will be accepted by the FSS at the point of departure. If VFR flight is conducted for the first portion of the flight, pilots should report their departure time to the FSS with whom the VFR/IFR flight plan was filed; and, subsequently, close the VFR portion and request ATC clearance from the FSS nearest the point at which change from VFR to IFR is proposed. Regardless of the type facility you are communicating with (FSS, center, or tower), it is the pilot's responsibility to request that facility to "CLOSE VFR FLIGHT PLAN." The pilot must remain in VFR weather conditions until operating in accordance with the IFR clearance.

b. When a flight plan indicates IFR for the first portion of flight and VFR for the latter portion, the pilot will normally be cleared to the point at which the change is proposed. After reporting over the clearance limit and not desiring further IFR clearance, the pilot should advise ATC to cancel the IFR portion of the flight plan. Then, the pilot should contact the nearest FSS to activate the VFR portion of the flight plan. If the pilot desires to continue the IFR flight plan beyond the clearance limit, the pilot should contact ATC at least 5 minutes prior to the clearance limit and request further IFR clearance. If the requested clearance is not received prior to reaching the clearance limit fix, the pilot will be expected to enter into a standard holding pattern on the radial or course to the fix unless a holding pattern for the clearance limit fix is depicted on a U.S. Government or commercially produced (meeting FAA requirements) low or high altitude enroute, area or STAR chart. In this case the pilot will hold according to the depicted pattern.

5-1-8. Flight Plan (FAA Form 7233-1)- Domestic IFR Flights

NOTE-

1. Procedures outlined in this section apply to operators filing FAA Form 7233-1 (Flight Plan) and to flights that will be conducted entirely within U.S. domestic airspace.

2. Filers utilizing FAA Form 7233-1 may not be eligible for assignment of RNAV SIDs and STARs. Filers desiring assignment of these procedures should file using FAA Form

7233-4 (International Flight Plan), as described in paragraph 5-1-9.

a. General

1. Prior to departure from within, or prior to entering controlled airspace, a pilot must submit a complete flight plan and receive an air traffic clearance, if weather conditions are below VFR minimums. Instrument flight plans may be submitted to the nearest FSS or ATCT either in person or by telephone (or by radio if no other means are available). Pilots should file IFR flight plans at least 30 minutes prior to estimated time of departure to preclude possible delay in receiving a departure clearance from ATC. In order to provide FAA traffic management units strategic route planning capabilities, nonscheduled operators conducting IFR operations above FL 230 are requested to voluntarily file IFR flight plans at least 4 hours prior to estimated time of departure (ETD). To minimize your delay in entering Class B, Class C, Class D, and Class E surface areas at destination when IFR weather conditions exist or are forecast at that airport, an IFR flight plan should be filed before departure. Otherwise, a 30 minute delay is not unusual in receiving an ATC clearance because of time spent in processing flight plan data. Traffic saturation frequently prevents control personnel from accepting flight plans by radio. In such cases, the pilot is advised to contact the nearest FSS for the purpose of filing the flight plan.

NOTE-

1. There are several methods of obtaining IFR clearances at nontower, non-FSS, and outlying airports. The procedure may vary due to geographical features, weather conditions, and the complexity of the ATC system. To determine the most effective means of receiving an IFR clearance, pilots should ask the nearest FSS the most appropriate means of obtaining the IFR clearance.

2. When requesting an IFR clearance, it is highly recommended that the departure airport be identified by stating the city name and state and/or the airport location identifier in order to clarify to ATC the exact location of the intended airport of departure.

2. When filing an IFR flight plan, include as a prefix to the aircraft type, the number of aircraft when more than one and/or heavy aircraft indicator "H/" if appropriate.

EXAMPLE-

H/DC10/A
2/F15/A

3. When filing an IFR flight plan, identify the equipment capability by adding a suffix, preceded by a slant, to the AIRCRAFT TYPE, as shown in TBL 5-1-3, Aircraft Suffixes.

NOTE-

1. ATC issues clearances based on filed suffixes. Pilots should determine the appropriate suffix based upon desired services and/or routing. For example, if a desired route/procedure requires GPS, a pilot should file /G even if the aircraft also qualifies for other suffixes.
2. For procedures requiring GPS, if the navigation system does not automatically alert the flight crew of a loss of GPS, the operator must develop procedures to verify correct GPS operation.
3. The suffix is not to be added to the aircraft identification or be transmitted by radio as part of the aircraft

identification.

4. It is recommended that pilots file the maximum transponder or navigation capability of their aircraft in the equipment suffix. This will provide ATC with the necessary information to utilize all facets of navigational equipment and transponder capabilities available.

5. When filing an IFR flight plan via telephone or radio, it is highly recommended that the departure airport be clearly identified by stating the city name and state and/or airport location identifier. With cell phone use and flight service specialists covering larger areas of the country, clearly identifying the departure airport can prevent confusing your airport of departure with those of identical or similar names in other states.

**TBL 5-1-3
Aircraft Equipment Suffixes**

	Navigation Capability	Transponder Capability	Suffix
RVSM	No GNSS, No RNAV	Transponder with Mode C	/W
	RNAV, No GNSS	Transponder with Mode C	/Z
	GNSS	Transponder with Mode C	/L
No RVSM	No DME	No Transponder	/X
		Transponder with no Mode C	/T
		Transponder with Mode C	/U
	DME	No Transponder	/D
		Transponder with no Mode C	/B
		Transponder with Mode C	/A
	TACAN	No Transponder	/M
		Transponder with no Mode C	/N
		Transponder with Mode C	/P
	RNAV, no GNSS	No Transponder	/Y
		Transponder with no Mode C	/C
		Transponder with Mode C	/I
	GNSS	No Transponder	/V
		Transponder with no Mode C	/S
		Transponder with Mode C	/G

b. Airways and Jet Routes Depiction on Flight Plan

1. It is vitally important that the route of flight be accurately and completely described in the flight plan. To simplify definition of the proposed route, and to facilitate ATC, pilots are requested to file via airways or jet routes established for use at the altitude or flight level planned.

2. If flight is to be conducted via designated airways or jet routes, describe the route by indicating the type and number designators of the airway(s) or jet route(s) requested. If more than one airway or jet route is to be used, clearly indicate points of transition. If the transition is made at an unnamed intersection, show the next succeeding NAVAID or named intersection on the intended route and the complete route from that point. Reporting points may be identified by using authorized name/code as depicted on appropriate aeronautical charts. The following two examples illustrate the need to specify the transition point when two routes share more than one transition fix.

EXAMPLE–

1. ALB J37 BUMPY J14 BHM

Spelled out: from Albany, New York, via Jet Route 37 transitioning to Jet Route 14 at BUMPY intersection, thence via Jet Route 14 to Birmingham, Alabama.

2. ALB J37 ENO J14 BHM

Spelled out: from Albany, New York, via Jet Route 37 transitioning to Jet Route 14 at Smyrna VORTAC (ENO) thence via Jet Route 14 to Birmingham, Alabama.

3. The route of flight may also be described by naming the reporting points or NAVAIDs over which the flight will pass, provided the points named are established for use at the altitude or flight level planned.

EXAMPLE–

BWI V44 SWANN V433 DQO

Spelled out: from Baltimore-Washington International, via Victor 44 to Swann intersection, transitioning to Victor 433 at Swann, thence via Victor 433 to Dupont.

4. When the route of flight is defined by named reporting points, whether alone or in combination with airways or jet routes, and the navigational aids (VOR, VORTAC, TACAN, NDB) to be used for the flight are a combination of different types of aids,

enough information should be included to clearly indicate the route requested.

EXAMPLE–

*LAX J5 LKV J3 GEG YXC FL 330 J500 VLR J515 YWG
Spelled out: from Los Angeles International via Jet Route 5 Lakeview, Jet Route 3 Spokane, direct Cranbrook, British Columbia VOR/DME, Flight Level 330 Jet Route 500 to Langruth, Manitoba VORTAC, Jet Route 515 to Winnipeg, Manitoba.*

5. When filing IFR, it is to the pilot's advantage to file a preferred route.

REFERENCE–

Preferred IFR Routes are described and tabulated in the Chart Supplement U.S.

6. ATC may issue a SID or a STAR, as appropriate.

REFERENCE–

AIM, Paragraph 5–2–9, Instrument Departure Procedures (DP) – Obstacle Departure Procedures (ODP) and Standard Instrument Departures (SID)

AIM, Paragraph 5–4–1, Standard Terminal Arrival (STAR) Procedures

NOTE–

Pilots not desiring a SID or STAR should so indicate in the remarks section of the flight plan as “no SID” or “no STAR.”

c. Direct Flights

1. All or any portions of the route which will not be flown on the radials or courses of established airways or routes, such as direct route flights, must be defined by indicating the radio fixes over which the flight will pass. Fixes selected to define the route must be those over which the position of the aircraft can be accurately determined. Such fixes automatically become compulsory reporting points for the flight, unless advised otherwise by ATC. Only those navigational aids established for use in a particular structure; i.e., in the low or high structures, may be used to define the en route phase of a direct flight within that altitude structure.

2. The azimuth feature of VOR aids and that azimuth and distance (DME) features of VORTAC and TACAN aids are assigned certain frequency protected areas of airspace which are intended for application to established airway and route use, and to provide guidance for planning flights outside of established airways or routes. These areas of airspace are expressed in terms of cylindrical service volumes of specified dimensions called “class limits” or “categories.”

REFERENCE–

AIM, Paragraph 1–1–8, Navigational Aid (NAVAID) Service Volumes

3. An operational service volume has been established for each class in which adequate signal coverage and frequency protection can be assured. To facilitate use of VOR, VORTAC, or TACAN aids, consistent with their operational service volume limits, pilot use of such aids for defining a direct route of flight in controlled airspace should not exceed the following:

(a) Operations above FL 450 – Use aids not more than 200 NM apart. These aids are depicted on enroute high altitude charts.

(b) Operation off established routes from 18,000 feet MSL to FL 450 – Use aids not more than 260 NM apart. These aids are depicted on enroute high altitude charts.

(c) Operation off established airways below 18,000 feet MSL – Use aids not more than 80 NM apart. These aids are depicted on enroute low altitude charts.

(d) Operation off established airways between 14,500 feet MSL and 17,999 feet MSL in the conterminous U.S. – (H) facilities not more than 200 NM apart may be used.

4. Increasing use of self-contained airborne navigational systems which do not rely on the VOR/VORTAC/TACAN system has resulted in pilot requests for direct routes that exceed NAVAID service volume limits. With the exception of GNSS-equipped aircraft, these direct route requests will be approved only in a radar environment, with approval based on pilot responsibility for navigation on the authorized direct route. Radar flight following will be provided by ATC for ATC purposes. For GNSS-equipped aircraft, ATC may approve a direct route that exceeds ground based NAVAID service volume limits; however, in a non-radar environment, the routing must be “point-to-point,” defined as navigation from a published point to a published point, and navigational assistance will not be available. (See subparagraph 5-1-8d below.)

5. At times, ATC will initiate a direct route in a radar environment that exceeds NAVAID service volume limits. In such cases ATC will provide radar monitoring and navigational assistance as necessary. For GNSS-equipped aircraft, if the route is point-to-point, radar monitoring and navigational assistance is not required. (See subparagraph 5-1-8d below.)

6. Airway or jet route numbers, appropriate to the stratum in which operation will be conducted, may also be included to describe portions of the route to be flown.

EXAMPLE–

MDW V262 BDF V10 BRL STJ SLN GCK

Spelled out: from Chicago Midway Airport via Victor 262 to Bradford, Victor 10 to Burlington, Iowa, direct St. Joseph, Missouri, direct Salina, Kansas, direct Garden City, Kansas.

NOTE–

When route of flight is described by radio fixes, the pilot will be expected to fly a direct course between the points named.

7. Pilots are reminded that they are responsible for adhering to obstruction clearance requirements on those segments of direct routes that are outside of controlled airspace. The MEAs and other altitudes shown on low altitude IFR enroute charts pertain to those route segments within controlled airspace, and those altitudes may not meet obstruction clearance criteria when operating off those routes.

d. Area Navigation (RNAV)/Global Navigation Satellite System (GNSS)

1. Except for GNSS-equipped aircraft, random impromptu routes can only be approved in a radar environment. A random impromptu route is a direct course initiated by ATC or requested by the pilot during flight. Aircraft are cleared from their present position to a NAVAID, waypoint, fix, or airport. Factors that will be considered by ATC in approving random impromptu routes include the capability to provide radar monitoring and compatibility with traffic volume and flow. ATC will radar monitor each flight; however, navigation on the random impromptu route is the responsibility of the pilot. GNSS-equipped aircraft are allowed to operate in a non-radar environment when the aircraft is cleared via, or is reported to be established on, a point-to-point route. The points must be published NAVAIDs, waypoints, fixes, or airports recallable from the aircraft's database. The distance between the points cannot exceed 500 miles and navigational assistance will not be provided.

2. Pilots of aircraft equipped with approved area navigation equipment may file for RNAV routes throughout the National Airspace System and may be filed for in accordance with the following procedures.

(a) File airport-to-airport flight plans.

(b) File the appropriate aircraft equipment suffix in the flight plan.

(c) Plan the random route portion of the flight plan to begin and end over appropriate arrival and departure transition fixes or appropriate navigation aids for the altitude stratum within which the flight will be conducted. The use of normal preferred departure and arrival routes (DP/STAR), where established, is recommended.

(d) File route structure transitions to and from the random route portion of the flight.

(e) Define the random route by waypoints. File route description waypoints by using degree-distance fixes based on navigational aids which are appropriate for the altitude stratum.

(f) File a minimum of one route description waypoint for each ARTCC through whose area the random route will be flown.

(g) File an additional route description waypoint for each turnpoint in the route.

(h) Plan additional route description waypoints as required to ensure accurate navigation via the filed route of flight. Navigation is the pilot's responsibility unless ATC assistance is requested.

(i) Plan the route of flight so as to avoid prohibited and restricted airspace by 3 NM unless permission has been obtained to operate in that airspace and the appropriate ATC facilities are advised.

NOTE-

To be approved for use in the National Airspace System, RNAV equipment must meet system availability, accuracy, and airworthiness standards. For additional information and guidance on RNAV equipment requirements, see Advisory Circular (AC) 20-138, Airworthiness Approval of Positioning and Navigation Systems, and AC 90-100, U.S. Terminal and En Route Area Navigation (RNAV) Operations.

3. Pilots of aircraft equipped with latitude/longitude coordinate navigation capability, independent of VOR/TACAN references, may file for random RNAV routes at and above FL 390 within the conterminous U.S. using the following procedures.

(a) File airport-to-airport flight plans prior to departure.

(b) File the appropriate RNAV capability certification suffix in the flight plan.

(c) Plan the random route portion of the flight to begin and end over published departure/arrival transition fixes or appropriate navigation aids for airports without published transition procedures. The use of preferred departure and arrival routes, such as DP and STAR where established, is recommended.

(d) Plan the route of flight so as to avoid prohibited and restricted airspace by 3 NM unless permission has been obtained to operate in that airspace and the appropriate ATC facility is advised.

(e) Define the route of flight after the departure fix, including each intermediate fix (turnpoint) and the arrival fix for the destination airport in terms of latitude/longitude coordinates plotted to the nearest minute or in terms of Navigation Reference System (NRS) waypoints. For latitude/longitude filing the arrival fix must be identified by both the latitude/longitude coordinates and a fix identifier.

EXAMPLE-

MIA¹ SRQ² 3407/10615³ 3407/11546 TNP⁴ LAX⁵

¹ *Departure airport.*

² *Departure fix.*

³ *Intermediate fix (turning point).*

⁴ *Arrival fix.*

⁵ *Destination airport.*

or

ORD¹ IOW² KP49G³ KD34U⁴ KL16O⁵ OAL⁶ MOD2⁷ SFO⁸

¹ *Departure airport.*

² *Transition fix (pitch point).*

³ *Minneapolis ARTCC waypoint.*

⁴ *Denver ARTCC Waypoint.*

⁵ *Los Angeles ARTCC waypoint (catch point).*

⁶ *Transition fix.*

⁷ *Arrival.*

⁸ *Destination airport.*

(f) Record latitude/longitude coordinates by four figures describing latitude in degrees and minutes followed by a solidus and five figures describing longitude in degrees and minutes.

(g) File at FL 390 or above for the random RNAV portion of the flight.

(h) Fly all routes/route segments on Great Circle tracks or GPS-based tracks.

(i) Make any inflight requests for random RNAV clearances or route amendments to an en route ATC facility.

e. Flight Plan Form– See FIG 5–1–2.

f. Explanation of IFR Flight Plan Items.

1. Block 1. Check the type flight plan. Check both the VFR and IFR blocks if composite VFR/IFR.

2. Block 2. Enter your complete aircraft identification including the prefix “N” if applicable.

3. Block 3. Enter the designator for the aircraft, followed by a slant(/), and the transponder or DME equipment code letter; e.g., C–182/U. Heavy aircraft, add prefix “H” to aircraft type; example: H/DC10/U. Consult an FSS briefer for any unknown elements.

FIG 5–1–2
FAA Flight Plan
Form 7233–1 (8–82)

U.S. DEPARTMENT OF TRANSPORTATION FEDERAL AVIATION ADMINISTRATION		(FAA USE ONLY) <input type="checkbox"/> PILOT BRIEFING <input type="checkbox"/> VNR			TIME STARTED		SPECIALIST INITIALS	
FLIGHT PLAN		<input type="checkbox"/> STOPOVER						
1. TYPE	2. AIRCRAFT IDENTIFICATION	3. AIRCRAFT TYPE/SPECIAL EQUIPMENT	4. TRUE AIRSPEED	5. DEPARTURE POINT	6. DEPARTURE TIME		7. CRUISING ALTITUDE	
<input type="checkbox"/> VFR <input type="checkbox"/> IFR <input type="checkbox"/> DVFR			KTS		PROPOSED (Z)	ACTUAL (Z)		
8. ROUTE OF FLIGHT								
9. DESTINATION (Name of airport and city)			10. EST. TIME ENROUTE		11. REMARKS			
			HOURS	MINUTES				
12. FUEL ON BOARD		13. ALTERNATE AIRPORT(S)		14. PILOT'S NAME, ADDRESS & TELEPHONE NUMBER & AIRCRAFT HOME BASE			15. NUMBER ABOARD	
HOURS	MINUTES							
				17. DESTINATION CONTACT/TELEPHONE (OPTIONAL)				
16. COLOR OF AIRCRAFT		CIVIL AIRCRAFT PILOTS, FAR 91 requires you file an IFR flight plan to operate under instrument flight rules in controlled airspace. Failure to file could result in a civil penalty not to exceed \$1,000 for each violation (Section 901 of the Federal Aviation Act of 1958, as amended). Filing of a VFR flight plan is recommended as a good operating practice. See also Part 99 for requirements concerning DVFR flight plans.						
FAA Form 7233-1 (8-82)			CLOSE VFR FLIGHT PLAN WITH _____			FSS ON ARRIVAL		

4. Block 4. Enter your computed true airspeed (TAS).

NOTE–
 If the average TAS changes plus or minus 5 percent or 10 knots, whichever is greater, advise ATC.

5. Block 5. Enter the departure airport identifier code (or the airport name, city and state, if the identifier is unknown).

NOTE–
 Use of identifier codes will expedite the processing of your flight plan.

6. Block 6. Enter the proposed departure time in Coordinated Universal Time (UTC) (Z). If airborne, specify the actual or proposed departure time as appropriate.

7. Block 7. Enter the requested en route altitude or flight level.

NOTE–
 Enter only the initial requested altitude in this block. When more than one IFR altitude or flight level is desired along the route of flight, it is best to make a subsequent request direct to the controller.

8. Block 8. Define the route of flight by using NAVAID identifier codes (or names if the code is unknown), airways, jet routes, and waypoints (for RNAV).

NOTE–

Use NAVAIDs or waypoints to define direct routes and radials/bearings to define other unpublished routes.

9. Block 9. Enter the destination airport identifier code (or name if the identifier is unknown).

10. Block 10. Enter your estimated time en route based on latest forecast winds.

11. Block 11. Enter only those remarks pertinent to ATC or to the clarification of other flight plan information, such as the appropriate radiotelephony (call sign) associated with the FAA-assigned three-letter company designator filed in Block 2, if the radiotelephony is new or has changed within the last 60 days. In cases where there is no three-letter designator but only an assigned radiotelephony or an assigned three-letter designator is used in a medical emergency, the radiotelephony must be included in the remarks field. Items of a personal nature are not accepted.

NOTE–

1. The pilot is responsible for knowing when it is appropriate to file the radiotelephony in remarks under the 60-day rule or when using FAA special radiotelephony assignments.

2. “DVRSN” should be placed in Block 11 only if the pilot/company is requesting priority handling to their original destination from ATC as a result of a diversion as defined in the Pilot/Controller Glossary.

3. Do not assume that remarks will be automatically transmitted to every controller. Specific ATC or en route requests should be made directly to the appropriate controller.

12. Block 12. Specify the fuel on board, computed from the departure point.

13. Block 13. Specify an alternate airport if desired or required, but do not include routing to the alternate airport.

14. Block 14. Enter the complete name, address, and telephone number of pilot-in-command, or in the case of a formation flight, the formation commander. Enter sufficient information to identify home base, airport, or operator.

NOTE–

This information would be essential in the event of search and rescue operation.

15. Block 15. Enter the total number of persons on board including crew.

16. Block 16. Enter the predominant colors.

NOTE–

Close IFR flight plans with tower, approach control, or ARTCC, or if unable, with FSS. When landing at an airport with a functioning control tower, IFR flight plans are automatically canceled.

g. The information transmitted to the ARTCC for IFR flight plans will consist of only flight plan blocks 2, 3, 4, 5, 6, 7, 8, 9, 10, and 11.

5–1–9. International Flight Plan (FAA Form 7233–4)– IFR Flights (For Domestic or International Flights)

a. General

Use of FAA Form 7233–4 is:

1. Mandatory for assignment of RNAV SIDs and STARs or other PBN routing,

2. Mandatory for all IFR flights that will depart U.S. domestic airspace, and

3. Recommended for domestic IFR flights.

NOTE–

1. An abbreviated description of FAA Form 7233–4 (International Flight Plan) may be found in this section. A detailed description of FAA Form 7233–4 may be found on the FAA website at:

http://www.faa.gov/about/office_org/headquarters_offices/ato/service_units/enroute/flight_plan_filing/

2. Filers utilizing FAA Form 7233–1 (Flight Plan) may not be eligible for assignment of RNAV SIDs and STARs. Filers desiring assignment of these procedures should file using FAA Form 7233–4, as described in this section.

3. When filing an IFR flight plan using FAA Form 7233–4, it is recommended that filers include all operable navigation, communication, and surveillance equipment capabilities by adding appropriate equipment qualifiers as shown in Tables 5–1–3 and 5–1–4. These equipment qualifiers should be filed in Item 10 of FAA Form 7233–4.

4. ATC issues clearances based on aircraft capabilities filed in Items 10 and 18 of FAA Form 7233–4. Operators should file all capabilities for which the aircraft and crew is certified, capable, and authorized. PBN/ capability should be filed as per paragraph 5-1-9 b 8 Items 18 (c) and (d).

b. Explanation of Items Filed in FAA Form 7233-4

Procedures and other information provided in this section are designed to assist operators using FAA Form 7233-4 to file IFR flight plans for flights that will be conducted entirely within U.S. domestic airspace. Requirements and procedures for operating outside U.S. domestic airspace may vary significantly from country to country. It is, therefore, recommended that operators planning flights outside U.S. domestic airspace become familiar with applicable international documents, including Aeronautical Information Publications (AIP); and ICAO Document 4444, Procedures for Air Navigation Services/Air Traffic Management, Appendix 2.

NOTE-

FAA Form 7233-4 is shown in FIG 5-1-3. The filer is normally responsible for providing the information required in Items 3 through 19.

1. Item 7. Aircraft Identification. Insert the full registration number of the aircraft, or the approved FAA/ICAO company or organizational designator, followed by the flight number.

EXAMPLE-

N235RA, AAL3342, BONGO33

NOTE-

Callsigns filed in this item must begin with a letter followed by 1-6 additional alphanumeric characters.

2. Item 8. Flight Rules and Type of Flight.

(a) Flight Rules. Insert the character "I" to indicate IFR

(b) Type of Flight. Insert one of the following letters to denote the type of flight:

- (1) **S** if scheduled air service
- (2) **N** if non-scheduled air transport operation
- (3) **G** if general aviation

(4) **M** if military

(5) **X** if other than any of the defined categories above.

NOTE-

Type of flight is optional for flights that will be conducted entirely within U.S. domestic airspace.

3. Item 9. Number, Type of Aircraft, and Wake Turbulence Category.

(a) Number. Insert the number of aircraft, if more than 1 (maximum 99).

(b) Type of Aircraft.

(1) Insert the appropriate designator as specified in ICAO Doc 8643, Aircraft Type Designators;

(2) Or, if no such designator has been assigned, or in the case of formation flights consisting of more than one type;

(3) Insert *ZZZZ*, and specify in Item 18, the (numbers and) type(s) of aircraft preceded by TYP/.

(c) Wake Turbulence Category. Insert an oblique stroke followed by one of the following letters to indicate the wake turbulence category of the aircraft:

(1) H — HEAVY, to indicate an aircraft type with a maximum certificated takeoff weight of 300,000 pounds (136 000 kg), or more;

(2) M — MEDIUM, to indicate an aircraft type with a maximum certificated takeoff weight of less than 300,000 pounds (136,000 kg), but more than 15,500 pounds (7,000 kg);

(3) L — LIGHT, to indicate an aircraft type with a maximum certificated takeoff weight of 15,500 pounds (7,000 kg) or less.

4. Item 10. Equipment

FIG 5-1-3
FAA International Flight Plan Form 7233-4 (9-06)

Form Approved OMB No. 2120-0026
09/30/2006

U.S. Department of Transportation Federal Aviation Administration		International Flight Plan	
PRIORITY <=FF	ADDRESSEE(S)		
FILING TIME			
ORIGINATOR			<=
SPECIFIC IDENTIFICATION OF ADDRESSEE(S) AND/OR ORIGINATOR			
3 MESSAGE TYPE <=(FPL	7 AIRCRAFT IDENTIFICATION	8 FLIGHT RULES	TYPE OF FLIGHT <=
9 NUMBER	TYPE OF AIRCRAFT	WAKE TURBULENCE CAT.	10 EQUIPMENT <=
13 DEPARTURE AERODROME		TIME	<=
15 CRUISING SPEED	LEVEL	ROUTE	
TOTAL EET			
16 DESTINATION AERODROME	HR MIN	ALTN AERODROME	2ND ALTN AERODROME <=
18 OTHER INFORMATION			
<=			
SUPPLEMENTARY INFORMATION (NOT TO BE TRANSMITTED IN FPL MESSAGES)			
19 ENDURANCE HR MIN	PERSONS ON BOARD	EMERGENCY RADIO	
E/ [] []	P/ [] []	R/ UHF [] VHF [] ELBA []	
SURVIVAL EQUIPMENT		JACKETS	
POLAR [] DESERT [] MARITIME [] JUNGLE []	LIGHT [] FLUORES [] UH [] VHF []		
DINGHIES			
NUMBER [] CAPACITY [] COVER []	COLOR []	<=	
A/ AIRCRAFT COLOR AND MARKINGS			
N/ REMARKS <=			
C/ PILOT-IN-COMMAND)<=			
FILED BY	ACCEPTED BY	ADDITIONAL INFORMATION	

FAA Form 7233-4 (7-93)

Pre-Flight Pilot Checklist

Aircraft Identification			Time of Briefing			
Weather <i>(Destination) (Alternate)</i>	<input type="checkbox"/> Present	Remarks	Report Weather Conditions Aloft			
	<input type="checkbox"/> Forecast		<i>Report immediately weather conditions encountered--particularly cloud tops, upper cloud layers, thunderstorms, ice, turbulence, winds and temperature</i>			
			Position	Altitude	Time	Weather Conditions
Weather <i>(En Route)</i>	<input type="checkbox"/> Present					
	<input type="checkbox"/> Forecast					
	<input type="checkbox"/> Pireps					
Winds Aloft	Best Crzg. Alt.					
Nav. Aid & Comm. Status.	<input type="checkbox"/> Destination					
	<input type="checkbox"/> En Route					
Airport Conditions	<input type="checkbox"/> Destination					
	<input type="checkbox"/> Alternate					
ADIZ	<input type="checkbox"/> Airspace Restrictions					
Civil Aircraft Pilots						
<p>FAR Part 91 states that each person operating a civil aircraft of U.S. registry over the high seas shall comply with Annex 2 to the <u>Convention of International Civil Aviation, International Standards - Rules of the Air</u>. Annex 2 requires the submission of a flight plan containing items 1-19 prior to operating any flight across international waters. Failure to file could result in a civil penalty not to exceed \$1,000 for each violation (Section 901 of the Federal Aviation Act of 1958, as amended).</p>						
<i>International briefing information may not be current or complete. Data should be secured, at the first opportunity, from the country in whose airspace the flight will be conducted.</i>						
<p>Paperwork Reduction Act Statement: Flight Plan information is collected for the protection and identification of aircraft and property and persons on the ground. Air Traffic uses the information to provide control services and search and rescue services. An individual respondent would require about 2.5 minutes to provide the information. FAR Part 91 requires an Instrument Flight Rules (IFR) flight plan to operate under IFR in controlled airspace. Filing a Visual Flight Rules flight plan is recommended but not mandatory. It is FAA policy to make factual information available to persons properly and directly concerned except information held confidential for good cause, i.e., pilot's address/telephone number. All flight plan data is destroyed when 15 days old except for data retained due to an accident/incident investigation. An agency may not conduct or sponsor, and a person is not required to respond to, a collection of information unless it displays a currently valid OMB control number. The OMB control number associated with this collection is 2120-0026. Comments concerning the accuracy of this burden and suggestions for reducing the burden should be directed to the FAA at: 800 Independence Ave SW, Washington, DC 20591, Attn: Information Collection Clearance Officer, ABA-20</p>						

TBL 5-1-4
Aircraft COM, NAV, and Approach Equipment Qualifiers

INSERT one letter as follows:

N if no COM/NAV/approach aid equipment for the route to be flown is carried, or the equipment is unserviceable,

(OR)

S if standard COM/NAV/approach aid equipment for the route to be flown is carried and serviceable (see Note 1),

(AND/OR)

INSERT one or more of the following letters to indicate the COM/NAV/approach aid equipment available and serviceable:

NOTE-

The capabilities described below comprise the following elements:

- a. Presence of relevant serviceable equipment on board the aircraft.*
- b. Equipment and capabilities commensurate with flight crew qualifications.*
- c. Where applicable, authorization from the appropriate authority.*

A	GBAS landing system	L	ILS
B	LPV (APV with SBAS)	M1	ATC RTF SATCOM (INMARSAT)
C	LORAN C	M2	ATC RTF (MTSAT)
D	DME	M3	ATC RTF (Iridium)
E1	FMC WPR ACARS	O	VOR
E2	D-FIS ACARS	P1	CPDLC RCP 400 (See Note 7.)
E3	PDC ACARS	P2	CPDLC RCP 240 (See Note 7.)
F	ADF	P3	SATVOICE RCP 400 (See Note 7.)
G	(GNSS) (See Note 2.)	P4- P9	Reserved for RCP
H	HF RTF	R	PBN approved (See Note 4.)
I	Inertial navigation	T	TACAN
J1	CPDLC ATN VDL Mode 2 (See Note 3.)	U	UHF RTF
J2	CPDLC FANS 1/A HF DL	V	VHF RTF
J3	CPDLC FANS 1/A VDL Mode 4	W	RVSM approved
J4	CPDLC FANS 1/A VDL Mode 2	X	MNPS approved/North Atlantic (NAT) High Level Airspace (HLA) approved
J5	CPDLC FANS 1/A SATCOM (INMARSAT)	Y	VHF with 8.33 kHz channel spacing capability
J6	CPDLC FANS 1/A SATCOM (MTSAT)	Z	Other equipment carried or other capabilities (See Note 5.)
J7	CPDLC FANS 1/A SATCOM (Iridium)		

NOTE-

- 1.** *If the letter S is used, standard equipment is considered to be VHF RTF, VOR, and ILS within U.S. domestic airspace.*
- 2.** *If the letter G is used, the types of external GNSS augmentation, if any, are specified in Item 18 following the indicator NAV/ and separated by a space.*
- 3.** *See RTCA/EUROCAE Interoperability Requirements Standard For ATN Baseline 1 (ATN B1 INTEROP Standard – DO-280B/ED-110B) for data link services air traffic control clearance and information/air traffic control communications management/air traffic control microphone check.*
- 4.** *If the letter R is used, the performance-based navigation levels that are authorized must be specified in Item 18 following the indicator PBN/. For further details, see Paragraph 5-1-9 b 8, Item 18 (c) and (d).*

- 5. If the letter Z is used, specify in Item 18 the other equipment carried, preceded by COM/, DAT/, and/or NAV/, as appropriate.
- 6. Information on navigation capability is provided to ATC for clearance and routing purposes.
- 7. Guidance on the application of performance-based communication, which prescribes RCP to an air traffic service in a specific area, is contained in the Performance-Based Communication and Surveillance (PBCS) Manual (Doc 9869).

TBL 5-1-5

Aircraft Surveillance Equipment, Including Designators for Transponder, ADS-B, ADS-C, and Capabilities

<p><i>INSERT N</i> if no surveillance equipment for the route to be flown is carried, or the equipment is unserviceable, OR <i>INSERT</i> one or more of the following descriptors, to a maximum of 20 characters, to describe the serviceable surveillance equipment and/or capabilities on board:</p>	
SSR Modes A and C	
A	Transponder - Mode A (4 digits – 4096 codes)
C	Transponder - Mode A (4 digits – 4096 codes) and Mode C
SSR Mode S	
E	Transponder - Mode S, including aircraft identification, pressure-altitude and extended squitter (ADS-B) capability
H	Transponder - Mode S, including aircraft identification, pressure-altitude and enhanced surveillance capability
I	Transponder - Mode S, including aircraft identification, but no pressure-altitude capability
L	Transponder - Mode S, including aircraft identification, pressure-altitude, extended squitter (ADS B) and enhanced surveillance capability
P	Transponder - Mode S, including pressure-altitude, but no aircraft identification capability
S	Transponder - Mode S, including both pressure-altitude and aircraft identification capability
X	Transponder - Mode S with neither aircraft identification nor pressure-altitude capability
<p>NOTE- <i>Enhanced surveillance capability is the ability of the aircraft to down-link aircraft derived data via a Mode S transponder.</i></p>	
Followed by one or more of the following codes if the aircraft has ADS-B capability:	
B1	ADS-B with dedicated 1090 MHz ADS-B “out” capability
B2	ADS-B with dedicated 1090 MHz ADS-B “out” and “in” capability
U1	ADS-B “out” capability using UAT
U2	ADS-B “out” and “in” capability using UAT
V1	ADS-B “out” capability using VDL Mode 4
V2	ADS-B “out” and “in” capability using VDL Mode 4
<p>NOTE- <i>File no more than one code for each type of capability; for example, file B1 or B2, but not both.</i></p>	
Followed by one or more of the following codes if the aircraft has ADS-C capability:	
D1	ADS-C with FANS 1/A capabilities
G1	ADS-C with ATN capabilities

EXAMPLE-

- 1. SDGW/SB1U1 {VOR, ILS, VHF, DME, GNSS, RVSM, Mode S transponder, ADS-B 1090 Extended Squitter out, ADS-B UAT out}
- 2. S/C {VOR, ILS, VHF, Mode C transponder}

5. Item 13. Departure Aerodrome/Time

(a) Insert the ICAO four-letter location indicator of the departure aerodrome, or

NOTE-

ICAO location indicators must consist of 4 letters. Airport identifiers such as 51A7, 39LL and Z40 are not in ICAO standard format.

(b) If no four-letter location indicator has been assigned to the departure aerodrome, insert ZZZZ and specify the non-ICAO location identifier, or fix/radial/distance from a nearby navaid, followed by the name of the aerodrome, in Item 18, following characters DEP/,

(c) Then, without a space, insert the estimated off-block time.

EXAMPLE-

1. KSMF2215

2. ZZZZ0330

6. Item 15. Cruise Speed, Level and Route

(a) Cruise Speed (maximum 5 characters). Insert the true airspeed for the first or the whole cruising portion of the flight, in terms of knots, expressed as N followed by 4 digits (e.g. N0485), or Mach number to the nearest hundredth of unit Mach, expressed as M followed by 3 digits (for example, M082).

(b) Cruising level (maximum 5 characters). Insert the planned cruising level for the first or the whole portion of the route to be flown, in terms of flight level, expressed as F followed by 3 figures (for example, F180; F330), or altitude in hundreds of feet, expressed as A followed by 3 figures (for example, A040; A170).

(c) Route. Insert the requested route of flight in accordance with guidance below.

NOTE-

Speed and/or altitude changes en route will be accepted by FAA computer systems, but will not be processed or forwarded to controllers. Pilots are expected to maintain the last assigned altitude and request revised altitude clearances directly from ATC.

(d) Insert the desired route of flight using a combination of published routes and/or fixes in the following formats:

(1) Consecutive fixes, navaids and waypoints should be separated by the characters "DCT", meaning direct.

EXAMPLE-

FLACK DCT IRW DCT IRW125023

NOTE-

IRW125023 identifies the fix located on the Will Rogers VORTAC 125 radial at 23 DME.

(2) Combinations of published routes, and fixes, navaids or waypoints should be separated by a single space.

EXAMPLE-

WORTH5 MQP V66 ABI V385

(3) Although it is recommended that filed airway junctions be identified using a named junction fix when possible, there may be cases where it is necessary to file junctioning airways without a named fix. In these cases, separate consecutive airways with a space.

EXAMPLE-

V325 V49

NOTE-

This method of filing an airway junction may result in a processing ambiguity. This might cause the flight plan to be rejected in some cases.

7. Item 16. Destination Aerodrome, Total EET, Alternate and 2nd Alternate Aerodrome

(a) Destination Aerodrome and Total Estimated Elapsed Time (EET).

(1) Insert the ICAO four-letter location identifier for the destination aerodrome; or, if no ICAO location identifier has been assigned, (Location identifiers, such as WY66, A08, and 5B1, are not an ICAO standard format),

(2) Insert ZZZZ and specify the non-ICAO location identifier, or fix/radial/distance from a nearby navaid, followed the name of the aerodrome, in Item 18, following characters DEST/,

(3) Then, without a space, insert the total estimated time en route to the destination.

EXAMPLE-

1. KOKC0200

2. ZZZZ0330

(b) Alternate and 2nd Alternate Aerodrome (Optional).

(1) Following the intended destination, insert the ICAO four-letter location identifier(s) of

alternate aerodromes; or, if no location identifier(s) have been assigned;

(2) Insert ZZZZ and specify the name of the aerodrome in Item 18, following the characters ALTN/.

EXAMPLE-

1. KDFW0234 KPWA

2. KBOS0304 ZZZZ

NOTE-

Although alternate airport information filed in an FPL will be accepted by air traffic computer systems, it will not be presented to controllers. If diversion to an alternate airport becomes necessary, pilots are expected to notify ATC and request an amended clearance.

8. Item 18. Other Information

(a) Insert 0 (zero) if no other information; or, any other necessary information in the sequence shown below, in the form of the appropriate indicator followed by an oblique stroke and the information to be recorded:

NOTE-

1. Operators are warned that the use of indicators not included in the provisions may result in data being rejected, processed incorrectly, or lost.

2. Hyphens “-” or oblique strokes “/” should only be used as described.

3. Avoid use of any other special characters in Field 18 information- use only letters and numbers.

4. An indicator without any associated information will result in flight plan rejection.

(b) STS/ Reason for special handling by ATS as follows:

(1) ALTRV: For a flight operated in accordance with an altitude reservation.

(2) ATFMX: For a flight approved for exemption from ATFM measures by the appropriate ATS authority.

(3) FFR: Fire-fighting.

(4) FLTCK: Flight check for calibration of nav aids.

(5) HAZMAT: For a flight carrying hazardous material.

(6) HEAD: A flight with Head of State status.

(7) HOSP: For a medical flight declared by medical authorities.

(8) HUM: For a flight operating on a humanitarian mission.

(9) MARSAS: For a flight for which a military entity assumes responsibility for separation of military aircraft.

(10) MEDEVAC: For a life critical medical emergency evacuation.

(11) NONRVSM: For a non-RVSM capable flight intending to operate in RVSM airspace.

(12) SAR: For a flight engaged in a search and rescue mission.

(13) STATE: For a flight engaged in military, customs, or police services.

NOTE-

Other reasons for special handling by ATS are denoted under the designator RMK/.

(c) PBN/ Indication of RNAV and/or RNP capabilities. Include as many of the descriptors below as apply to the flight, up to a maximum of 8 entries; that is a total of not more than 16 characters.

**TBL 5-1-6
PBN/RNAV Specifications**

PBN/	RNAV SPECIFICATIONS
A1	RNAV 10 (RNP 10)
B1	RNAV 5 all permitted sensors
B2	RNAV 5 GNSS
B3	RNAV 5 DME/DME
B4	RNAV 5 VOR/DME
B5	RNAV 5 INS or IRS
B6	RNAV 5 LORAN C
C1	RNAV 2 all permitted sensors
C2	RNAV 2 GNSS
C3	RNAV 2 DME/DME
C4	RNAV 2 DME/DME/IRU
D1	RNAV 1 all permitted sensors
D2	RNAV 1 GNSS
D3	RNAV 1 DME/DME
D4	RNAV 1 DME/DME/IRU

	RNP SPECIFICATIONS
L1	RNP 4
O1	Basic RNP 1 all permitted sensors
O2	Basic RNP 1 GNSS
O3	Basic RNP 1 DME/DME
O4	Basic RNP 1 DME/DME/IRU
S1	RNP APCH
S2	RNP APCH with BARO-VNAV
T1	RNP AR APCH with RF (special authorization required)
T2	RNP AR APCH without RF (special authorization required)

NOTE-
Combinations of alphanumeric characters not indicated above are reserved.

(d) NAV/ Significant data related to navigation equipment, other than as specified in PBN/.

(1) When Performance Based Navigation Capability has been filed in PBN/, if PBN routing is desired for only some segment(s) of the flight then that information can be conveyed by inserting the character “Z” in Item 10 and “NAV/RNV” in field 18 followed by the appropriate RNAV accuracy value(s) per the following:

[a] To be assigned an RNAV 1 SID, insert the characters “D1”.

[b] To be assigned an RNAV 1 STAR, insert the characters “A1”.

[c] To be assigned en route extensions and/or RNAV PTP, insert the characters “E2”.

[d] To prevent assignment of an RNAV route or procedure, insert a numeric value of “0” for the segment of the flight. Alternatively, you may simply remove the segment of the flight indicator and numeric value from the character string.

EXAMPLE-

1. NAV/RNVD1 or NAV/RNVD1E0A0 (Same meaning)
2. NAV/RNVA1 or NAV/RNVD0E0A1 (Same meaning)
3. NAV/RNVE2 or NAV/RNVD0E2A0 (Same meaning)
4. NAV/RNVD1A1 or NAV/RNVD1E0A1 (Same meaning)
5. NAV/RNVD1E2A1

NOTE-

1. Route assignments are predicated on NAV/ data over PBN/ data in ERAS.

2. Aircraft certification requirements for RNAV operations within U.S. airspace are defined in AC 20-138, Airworthiness Approval of Positioning and Navigation Systems, and AC 90-100, U.S. Terminal and En Route Area Navigation (RNAV) Operations.

(2) Operators should file their maximum capabilities in order to qualify for the most advanced procedures.

(e) COM/ Indicate communications capabilities not specified in Item 10a, when requested by an air navigation service provider.

(f) DAT/ Indicate data applications or capabilities not specified in Item 10a, when requested by an Air Navigation Service Provider.

(g) SUR/ Indicate surveillance capabilities not specified in Item 10b, when requested by an Air Navigation Service Provider.

(1) If ADS-B capability filed in Item 10 is compliant with RTCA DO-260B, include the item “260B” in SUR/. If ADS-B capability filed in Item 10 is compliant with RTCA DO-282B, include the item “282B” in SUR/.

EXAMPLE-

1. SUR/260B
2. SUR/260B 282B

(2) When Required Surveillance Performance (RSP) Capability has been filed in SUR/, this can be conveyed by inserting the character “Z” in Item 10 and “SUR/” in field 18 followed by the appropriate RSP performance per the following:

[a] For RSP 180 – flight plan RSP180

[b] For RSP 400 – flight plan RSP400

EXAMPLE-

1. SUR/ RSP180
2. SUR/ RSP400
3. SUR/ RSP180 RSP400

(h) DEP/ Insert the non-ICAO identifier, or fix/radial/distance from navaid, or latitude/longitude, if ZZZZ is inserted in Item 13. Optionally, append the name of the departure point.

EXAMPLE-

1. DEP/T23 ALBANY MUNI
2. DEP/T23
3. DEP/UKW197011 TICK HOLLR RANCH
4. DEP/4620N07805W

(i) DEST/ Insert the non-ICAO identifier, or fix/radial/distance from navaid, or latitude/longitude, if ZZZZ is inserted in Item 16. Optionally, append the name of the destination point.

EXAMPLE-

1. DEST/T23 ALBANY MUNI
2. DEST/PIE335033 LEXI DUNES
3. DEST/4620N07805W

(j) DOF/ The date of flight departure in a six figure format (YYMMDD, where YY equals the year, MM equals the month, and DD equals the day). The FAA will not accept flight plans filed with Date of Flight resulting in more than a day in advance.

(k) REG/ The registration markings of the aircraft, if different from the aircraft identification in Item 7. Note that the FAA uses this information in monitoring of RVSM and ADS-B performance.

(l) EET/ Significant points or FIR boundary designators and accumulated estimated elapsed times to such points or FIR boundaries.

EXAMPLE-

EET/KZLA0745 KZAB0830

(m) SEL/ SELCAL code.

(n) TYP/ Insert the type of aircraft if ZZZZ was entered in Item 9. If necessary, insert the number and type(s) of aircraft in a formation.

EXAMPLE-

1. TYP/Homebuilt
2. TYP/2 P51 B17 B24

(o) CODE/ Aircraft address (expressed in the form of an alphanumerical code of six hexadecimal characters) when required by the appropriate ATS authority. Include CODE/ when ADS-B capability is filed in Item 10.

EXAMPLE-

"F00001" is the lowest aircraft address contained in the specific block administered by ICAO.

(p) DLE/ En route delay or holding, insert the significant point(s) on the route where a delay is planned to occur, followed by the length of delay using four figure time in hours and minutes (hhmm).

EXAMPLE-

DLE/MDG0030

(q) OPR/ Name of the operator, if not obvious from the aircraft identification in Item 7.

(r) ORGN/ The originator's 8-letter AFTN address or other appropriate contact details, in cases where the originator of the flight plan may not be readily identified, as required by the appropriate ATS authority. The FAA does not require ORGN/ information.

NOTE-

In some areas, flight plan reception centers may insert the ORGN/ identifier and originator's AFTN address automatically.

(s) PER/ Aircraft performance data, indicated by a single letter as specified in the Procedures for Air Navigation Services - Aircraft Operations (PANS-OPS, Doc 8168), Volume I - Flight Procedures, if so prescribed by the appropriate ATS authority. Note that the FAA does not require PER/ information.

(t) ALTN/ Name of destination alternate aerodrome(s), if ZZZZ is inserted in Item 16.

EXAMPLE-

1. ALTN/F35 POSSUM KINGDOM
2. ALTN/TCC233016 LAZY S RANCH

(u) RALT/ ICAO 4-letter indicator(s) for en-route alternate(s), as specified in Doc 7910, Location Indicators, or name(s) of en-route alternate aerodrome(s), if no indicator is allocated. For aerodromes not listed in the relevant Aeronautical Information Publication, indicate location in LAT/LONG or bearing and distance from the nearest significant point, as described in DEP/ above.

(v) TALT/ ICAO 4-letter indicator(s) for take-off alternate, as specified in Doc 7910, Location Indicators, or name of take-off alternate aerodrome, if no indicator is allocated. For aerodromes not listed in the relevant Aeronautical Information Publication, indicate location in LAT/LONG or bearing and distance from the nearest significant point, as described in DEP/ above.

(w) RIF/ The route details to the revised destination aerodrome, followed by the ICAO four-letter location indicator of the aerodrome. The revised route is subject to reclearance in flight.

EXAMPLE-

1. RIF/DTA HEC KLAX
2. RIF/ESP G94 CLA YPPH

(x) RMK/ Any other plain-language remarks when required by the ATC or deemed necessary.

EXAMPLE-**1. RMK/NRP****2. RMK/DRVSN**

(y) RVR/ The minimum RVR requirement of the flight in meters. This item is defined by Eurocontrol, not ICAO. The FAA does not require or use this item, but will accept it in a flight plan.

NOTE-

This provision is detailed in the European Regional Supplementary Procedures (EUR SUPPs, Doc 7030), Chapter 2.

(z) RFP/ Q followed by a digit to indicate the sequence of the replacement flight plan being submitted. This item is defined by Eurocontrol, not ICAO. The FAA will not use this item, but will accept it in a flight plan.

NOTE-

This provision is detailed in the European Regional Supplementary Procedures (EUR SUPPs, Doc 7030), chapter 2.

9. Item 19. Supplementary Information**NOTE-**

Item 19 data must be included when completing FAA Form 7233-4. This information will be retained by the facility/organization that transmits the flight plan to Air Traffic Control (ATC), for Search and Rescue purposes, but it will not be transmitted to ATC as part of the FPL.

(a) E/ (ENDURANCE). Insert 4-digits group giving the fuel endurance in hours and minutes.

(b) P/ (PERSONS ON BOARD). Insert the total number of persons (passengers and crew) on board.

(c) Emergency and survival equipment

(1) R/ (RADIO).

[a] Cross out “UHF” if frequency 243.0 MHz is not available.

[b] Cross out “VHF” frequency 121.5 MHz is not available.

[c] Cross out “ELBA” if emergency locator transmitter (ELT) is not available.

(2) S/ (SURVIVAL EQUIPMENT).

[a] Cross out “POLAR” if polar survival equipment is not carried.

[b] Cross out “DESERT” if desert survival equipment is not carried.

[c] Cross out “MARITIME” if maritime survival equipment is not carried.

[d] Cross out J if “JUNGLE” survival equipment is not carried.

(3) J/ (JACKETS).

[a] Cross out “LIGHT” if life jackets are not equipped with lights.

[b] Cross out “FLUORES” if life jackets are not equipped with fluorescein.

[c] Cross out “UHF” or “VHF” or both as in R/ above to indicate radio capability of jackets, if any.

(4) D/ (DINGHIES).

[a] NUMBER. Cross out indicators “NUMBER” and “CAPACITY” if no dinghies are carried, or insert number of dinghies carried; and

[b] CAPACITY. Insert total capacity, in persons, of all dinghies carried; and

[c] COVER. Cross out indicator “COVER” if dinghies are not covered; and

[d] COLOR. Insert color of dinghies if carried.

(5) A/ (AIRCRAFT COLOR AND MARKINGS). Insert color of aircraft and significant markings.

(6) N/ (REMARKS). Cross out indicator N if no remarks, or indicate any other survival equipment carried and any other remarks regarding survival equipment.

(7) C/ (PILOT). Insert name of pilot-in-command.

5-1-10. IFR Operations to High Altitude Destinations

a. Pilots planning IFR flights to airports located in mountainous terrain are cautioned to consider the necessity for an alternate airport even when the forecast weather conditions would technically relieve them from the requirement to file one.

REFERENCE-

14 CFR Section 91.167.

AIM, Paragraph 4-1-19, Tower En Route Control (TEC)

b. The FAA has identified three possible situations where the failure to plan for an alternate airport when flying IFR to such a destination airport could result in a critical situation if the weather is less than forecast and sufficient fuel is not available to proceed to a suitable airport.

1. An IFR flight to an airport where the Minimum Descent Altitudes (MDAs) or landing visibility minimums for *all instrument approaches* are higher than the forecast weather minimums specified in 14 CFR Section 91.167(b). For example, there are 3 high altitude airports in the U.S. with approved instrument approach procedures where all of the MDAs are greater than 2,000 feet and/or the landing visibility minimums are greater than 3 miles (Bishop, California; South Lake Tahoe, California; and Aspen–Pitkin Co./Sardy Field, Colorado). In the case of these airports, it is possible for a pilot to elect, on the basis of forecasts, not to carry sufficient fuel to get to an alternate when the ceiling and/or visibility is actually lower than that necessary to complete the approach.

2. A small number of other airports in mountainous terrain have MDAs which are slightly (100 to 300 feet) below 2,000 feet AGL. In situations where there is an option as to whether to plan for an alternate, pilots should bear in mind that just a slight worsening of the weather conditions from those forecast could place the airport below the published IFR landing minimums.

3. An IFR flight to an airport which requires special equipment; i.e., DME, glide slope, etc., in order to make the available approaches to the lowest minimums. Pilots should be aware that all other minimums on the approach charts may require weather conditions better than those specified in 14 CFR Section 91.167(b). An inflight equipment malfunction could result in the inability to comply with the published approach procedures or, again, in the position of having the airport below the published IFR landing minimums for all remaining instrument approach alternatives.

5–1–11. Flights Outside U.S. Territorial Airspace

a. When conducting flights, particularly extended flights, outside the U.S. and its territories, full account should be taken of the amount and quality of air navigation services available in the airspace to be

traversed. Every effort should be made to secure information on the location and range of navigational aids, availability of communications and meteorological services, the provision of air traffic services, including alerting service, and the existence of search and rescue services.

b. Pilots should remember that there is a need to continuously guard the VHF emergency frequency 121.5 MHz when on long over-water flights, except when communications on other VHF channels, equipment limitations, or cockpit duties prevent simultaneous guarding of two channels. Guarding of 121.5 MHz is particularly critical when operating in proximity to Flight Information Region (FIR) boundaries, for example, operations on Route R220 between Anchorage and Tokyo, since it serves to facilitate communications with regard to aircraft which may experience in-flight emergencies, communications, or navigational difficulties.

REFERENCE–

ICAO Annex 10, Vol II, Paras 5.2.2.1.1.1 and 5.2.2.1.1.2.

c. The filing of a flight plan, always good practice, takes on added significance for extended flights outside U.S. airspace and is, in fact, usually required by the laws of the countries being visited or overflown. It is also particularly important in the case of such flights that pilots leave a complete itinerary and schedule of the flight with someone directly concerned and keep that person advised of the flight's progress. If serious doubt arises as to the safety of the flight, that person should first contact the appropriate FSS. Round Robin Flight Plans to Mexico are not accepted.

d. All pilots should review the foreign airspace and entry restrictions published in the appropriate Aeronautical Information Publication (AIP) during the flight planning process. Foreign airspace penetration without official authorization can involve both danger to the aircraft and the imposition of severe penalties and inconvenience to both passengers and crew. A flight plan on file with ATC authorities does not necessarily constitute the prior permission required by certain other authorities. The possibility of fatal consequences cannot be ignored in some areas of the world.

e. Current NOTAMs for foreign locations must also be reviewed. The Notices to Airmen Publication (NTAP), published every 28 days, contains considerable information pertinent to foreign flight. For additional flight information at foreign locations,

pilots should also review the FAA's Prohibitions, Restrictions, and Notices website at https://www.faa.gov/air_traffic/publications/us_restrictions/.

f. When customs notification to foreign locations is required, it is the responsibility of the pilot to arrange for customs notification in a timely manner.

g. Aircraft arriving to locations in U.S. territorial airspace must meet the entry requirements as described in AIM Section 6, National Security and Interception Procedures.

5-1-12. Change in Flight Plan

a. In addition to altitude or flight level, destination and/or route changes, increasing or decreasing the speed of an aircraft constitutes a change in a flight plan. Therefore, at any time the average true airspeed at cruising altitude between reporting points varies or is expected to vary from that given in the flight plan by *plus or minus 5 percent, or 10 knots, whichever is greater*, ATC should be advised.

b. All changes to existing flight plans should be completed more than 46 minutes prior to the proposed departure time. Changes must be made with the initial flight plan service provider. If the initial flight plan's service provider is unavailable, filers may contact an ATC facility or FSS to make the necessary revisions. Any revision 46 minutes or less from the proposed departure time must be coordinated through an ATC facility or FSS.

5-1-13. Change in Proposed Departure Time

a. To prevent computer saturation in the en route environment, parameters have been established to delete proposed departure flight plans which have not been activated. Most centers have this parameter set so as to delete these flight plans a minimum of 2 hours after the proposed departure time or Expect Departure Clearance Time (EDCT). To ensure that a flight plan remains active, pilots whose actual departure time will be delayed 2 hours or more beyond their filed departure time, are requested to notify ATC of their new proposed departure time.

b. Due to traffic saturation, ATC personnel frequently will be unable to accept these revisions via

radio. It is recommended that you forward these revisions to a flight plan service provider or FSS.

5-1-14. Closing VFR/DVFR Flight Plans

A pilot is responsible for ensuring that his/her VFR or DVFR flight plan is canceled. You should close your flight plan with the nearest FSS, or if one is not available, you may request any ATC facility to relay your cancellation to the FSS. Control towers do not automatically close VFR or DVFR flight plans since they do not know if a particular VFR aircraft is on a flight plan. If you fail to report or cancel your flight plan within $\frac{1}{2}$ hour after your ETA, search and rescue procedures are started.

REFERENCE-

14 CFR Section 91.153.

14 CFR Section 91.169.

5-1-15. Canceling IFR Flight Plan

a. 14 CFR Sections 91.153 and 91.169 include the statement "When a flight plan has been activated, the pilot-in-command, upon canceling or completing the flight under the flight plan, must notify an FAA Flight Service Station or ATC facility."

b. An IFR flight plan may be canceled at any time the flight is operating in VFR conditions outside Class A airspace by pilots stating "CANCEL MY IFR FLIGHT PLAN" to the controller or air/ground station with which they are communicating. Immediately after canceling an IFR flight plan, a pilot should take the necessary action to change to the appropriate air/ground frequency, VFR radar beacon code and VFR altitude or flight level.

c. ATC separation and information services will be discontinued, including radar services (where applicable). Consequently, if the canceling flight desires VFR radar advisory service, the pilot must specifically request it.

NOTE-

Pilots must be aware that other procedures may be applicable to a flight that cancels an IFR flight plan within an area where a special program, such as a designated TRSA, Class C airspace, or Class B airspace, has been established.

d. If a DVFR flight plan requirement exists, the pilot is responsible for filing this flight plan to replace the canceled IFR flight plan. If a subsequent IFR operation becomes necessary, a new IFR flight plan must be filed and an ATC clearance obtained before operating in IFR conditions.

e. If operating on an IFR flight plan to an airport with a functioning control tower, the flight plan is automatically closed upon landing.

f. If operating on an IFR flight plan to an airport where there is no functioning control tower, the pilot must initiate cancellation of the IFR flight plan. This can be done after landing if there is a functioning FSS or other means of direct communications with ATC. In the event there is no FSS and/or air/ground communications with ATC is not possible below a certain altitude, the pilot should, weather conditions permitting, cancel the IFR flight plan while still airborne and able to communicate with ATC by radio. This will not only save the time and expense of canceling the flight plan by telephone but will quickly release the airspace for use by other aircraft.

5-1-16. RNAV and RNP Operations

a. During the pre-flight planning phase the availability of the navigation infrastructure required for the intended operation, including any non-RNAV contingencies, must be confirmed for the period of intended operation. Availability of the onboard navigation equipment necessary for the route to be flown must be confirmed.

b. If a pilot determines a specified RNP level cannot be achieved, revise the route or delay the operation until appropriate RNP level can be ensured.

c. The onboard navigation database must be current and appropriate for the region of intended operation and must include the navigation aids, waypoints, and coded terminal airspace procedures for the departure, arrival and alternate airfields.

d. During system initialization, pilots of aircraft equipped with a Flight Management System or other RNAV-certified system, must confirm that the navigation database is current, and verify that the aircraft position has been entered correctly. Flight crews should crosscheck the cleared flight plan against charts or other applicable resources, as well as the navigation system textual display and the aircraft map display. This process includes confirmation of the waypoints sequence, reasonableness of track angles and distances, any altitude or speed constraints, and identification of fly-by or fly-over waypoints. A procedure must not be used if validity of the navigation database is in doubt.

e. Prior to commencing takeoff, the flight crew must verify that the RNAV system is operating correctly and the correct airport and runway data have been loaded.

f. During the pre-flight planning phase RAIM prediction must be performed if TSO-C129() equipment is used to solely satisfy the RNAV and RNP requirement. GPS RAIM availability must be confirmed for the intended route of flight (route and time) using current GPS satellite information. In the event of a predicted, continuous loss of RAIM of more than five (5) minutes for any part of the intended flight, the flight should be delayed, canceled, or re-routed where RAIM requirements can be met. Operators may satisfy the predictive RAIM requirement through any one of the following methods:

1. Operators may monitor the status of each satellite in its plane/slot position, by accounting for the latest GPS constellation status (for example, NOTAMs or NANUs), and compute RAIM availability using model-specific RAIM prediction software;

2. Operators may use the Service Availability Prediction Tool (SAPT) on the FAA en route and terminal RAIM prediction website;

3. Operators may contact a Flight Service Station to obtain non-precision approach RAIM;

4. Operators may use a third party interface, incorporating FAA/VOLPE RAIM prediction data without altering performance values, to predict RAIM outages for the aircraft's predicted flight path and times;

5. Operators may use the receiver's installed RAIM prediction capability (for TSO-C129a/Class A1/B1/C1 equipment) to provide non-precision approach RAIM, accounting for the latest GPS constellation status (for example, NOTAMs or NANUs). Receiver non-precision approach RAIM should be checked at airports spaced at intervals not to exceed 60 NM along the RNAV 1 procedure's flight track. "Terminal" or "Approach" RAIM must be available at the ETA over each airport checked; or,

6. Operators not using model-specific software or FAA/VOLPE RAIM data will need FAA operational approval.

NOTE-

If TSO-C145/C146 equipment is used to satisfy the RNAV and RNP requirement, the pilot/operator need not perform the prediction if WAAS coverage is confirmed to be

available along the entire route of flight. Outside the U.S. or in areas where WAAS coverage is not available, operators using TSO-C145/C146 receivers are required to check GPS RAIM availability.

5-1-17. Cold Temperature Operations

Pilots should begin planning for operating into airports with cold temperatures during the preflight planning phase. Instrument approach charts will contain a snowflake symbol and a temperature when cold temperature correction must be applied. Pilots operating into airports requiring cold temperature corrections should request the lowest forecast temperature at the airport for departure and arrival times. If the temperature is forecast to be at or below any published cold temperature restriction, calculate an altitude correction for the appropriate segment(s)

and/or review procedures for operating automatic cold temperature compensating systems, as applicable. The pilot is responsible to calculate and apply the corrections to the affected segment(s) when the actual reported temperature is at or below any published cold temperature restriction, or pilots with automatic cold temperature compensating systems must ensure the system is on and operating on each designated segment. Advise ATC when intending to apply cold temperature correction and of the amount of correction required on initial contact (or as soon as possible) for the intermediate segment and/or the published missed approach. This information is required for ATC to provide aircraft appropriate vertical separation between known traffic.

REFERENCE-

AIM, Paragraph 7-2-3, Altimeter Errors

AIM TBL 7-2-3, ICAO Cold Temperature Error

Section 2. Departure Procedures

5-2-1. Pre-taxi Clearance Procedures

a. Certain airports have established pre-taxi clearance programs whereby pilots of departing instrument flight rules (IFR) aircraft may elect to receive their IFR clearances before they start taxiing for takeoff. The following provisions are included in such procedures:

1. Pilot participation is not mandatory.
2. Participating pilots call clearance delivery or ground control not more than 10 minutes before proposed taxi time.
3. IFR clearance (or delay information, if clearance cannot be obtained) is issued at the time of this initial call-up.
4. When the IFR clearance is received on clearance delivery frequency, pilots call ground control when ready to taxi.
5. Normally, pilots need not inform ground control that they have received IFR clearance on clearance delivery frequency. Certain locations may, however, require that the pilot inform ground control of a portion of the routing or that the IFR clearance has been received.
6. If a pilot cannot establish contact on clearance delivery frequency or has not received an IFR clearance before ready to taxi, the pilot should contact ground control and inform the controller accordingly.

b. Locations where these procedures are in effect are indicated in the Chart Supplement U.S.

5-2-2. Automated Pre-Departure Clearance Procedures

a. Many airports in the National Airspace System are equipped with the Terminal Data Link System (TDLS) that includes the Pre-Departure Clearance (PDC) and Controller Pilot Data Link Communication-Departure Clearance (CPDLC-DCL) functions. Both the PDC and CPDLC-DCL functions automate the Clearance Delivery operations in the ATCT for participating users. Both functions display IFR clearances from the ARTCC to the ATCT. The Clearance Delivery controller in the ATCT can append local departure information and transmit the

clearance via data link to participating airline/service provider computers for PDC. The airline/service provider will then deliver the clearance via the Aircraft Communications Addressing and Reporting System (ACARS) or a similar data link system, or for non-data link equipped aircraft, via a printer located at the departure gate. For CPDLC-DCL, the departure clearance is uplinked from the ATCT via the Future Air Navigation System (FANS) to the aircraft avionics and requires a response from the flight crew. Both PDC and CPDLC-DCL reduce frequency congestion, controller workload, and are intended to mitigate delivery/read back errors.

b. Both services are available only to participating aircraft that have subscribed to the service through an approved service provider.

c. In all situations, the pilot is encouraged to contact clearance delivery if a question or concern exists regarding an automated clearance. Due to technical reasons, the following limitations/differences exist between the two services:

1. PDC

(a) Aircraft filing multiple flight plans are limited to one PDC clearance per departure airport within an 18-hour period. Additional clearances will be delivered verbally.

(b) If the clearance is revised or modified prior to delivery, it will be rejected from PDC and the clearance will need to be delivered verbally.

(c) No acknowledgment of receipt or read back is required for a PDC.

2. CPDLC-DCL

(a) No limitation to the number of clearances received.

(b) Allows delivery of revised flight data, including revised departure clearances.

(c) A response from the flight crew is required.

(d) Requires a logon to the FAA National Single Data Authority – KUSA – utilizing the ATC FANS application.

(e) To be eligible, operators must have received CPDLC/FANS authorization from the

responsible civil aviation authority, and file appropriate equipment information in ICAO field 10a and in the ICAO field 18 DAT (Other Data Applications) of the flight plan.

5-2-3. IFR Clearances Off Uncontrolled Airports

a. Pilots departing on an IFR flight plan should consult the Chart Supplement U.S. to determine the frequency or telephone number to use to contact clearance delivery. On initial contact, pilots should advise that the flight is IFR and state the departure and destination airports.

b. Air traffic facilities providing clearance delivery services via telephone will have their telephone number published in the Chart Supplement U.S. of that airport's entry. This same section may also contain a telephone number to use for cancellation of an IFR flight plan after landing.

c. Except in Alaska, pilots of MEDEVAC flights may obtain a clearance by calling 1-877-543-4733.

5-2-4. Taxi Clearance

Pilots on IFR flight plans should communicate with the control tower on the appropriate ground control or clearance delivery frequency prior to starting engines, to receive engine start time, taxi, and/or clearance information.

5-2-5. Line Up and Wait (LUAW)

a. Line up and wait is an air traffic control (ATC) procedure designed to position an aircraft onto the runway for an imminent departure. The ATC instruction "LINE UP AND WAIT" is used to instruct a pilot to taxi onto the departure runway and line up and wait.

EXAMPLE-

Tower: "N234AR Runway 24L, line up and wait."

b. This ATC instruction is not an authorization to takeoff. In instances where the pilot has been instructed to line up and wait and has been advised of a reason/condition (wake turbulence, traffic on an intersecting runway, etc.) or the reason/condition is clearly visible (another aircraft that has landed on or is taking off on the same runway), and the reason/condition is satisfied, the pilot should expect

an imminent takeoff clearance, unless advised of a delay. If you are uncertain about any ATC instruction or clearance, contact ATC immediately.

c. If a takeoff clearance is not received within a reasonable amount of time after clearance to line up and wait, ATC should be contacted.

EXAMPLE-

Aircraft: Cessna 234AR holding in position Runway 24L.

Aircraft: Cessna 234AR holding in position Runway 24L at Bravo.

NOTE-

FAA analysis of accidents and incidents involving aircraft holding in position indicate that two minutes or more elapsed between the time the instruction was issued to line up and wait and the resulting event (for example, land-over or go-around). Pilots should consider the length of time that they have been holding in position whenever they HAVE NOT been advised of any expected delay to determine when it is appropriate to query the controller.

REFERENCE-

Advisory Circulars 91-73A, Part 91 and Part 135 Single-Pilot Procedures during Taxi Operations, and 120-74A, Parts 91, 121, 125, and 135 Flightcrew Procedures during Taxi Operations

d. Situational awareness during line up and wait operations is enhanced by monitoring ATC instructions/clearances issued to other aircraft. Pilots should listen carefully if another aircraft is on frequency that has a similar call sign and pay close attention to communications between ATC and other aircraft. If you are uncertain of an ATC instruction or clearance, query ATC immediately. Care should be taken to not inadvertently execute a clearance/instruction for another aircraft.

e. Pilots should be especially vigilant when conducting line up and wait operations at night or during reduced visibility conditions. They should scan the full length of the runway and look for aircraft on final approach or landing roll out when taxiing onto a runway. ATC should be contacted anytime there is a concern about a potential conflict.

f. When two or more runways are active, aircraft may be instructed to "LINE UP AND WAIT" on two or more runways. When multiple runway operations are being conducted, it is important to listen closely for your call sign and runway. Be alert for similar sounding call signs and acknowledge all instructions with your call sign. When you are holding in position and are not sure if the takeoff clearance was for you, ask ATC before you begin takeoff roll. ATC prefers

that you confirm a takeoff clearance rather than mistake another aircraft's clearance for your own.

g. When ATC issues intersection "line up and wait" and takeoff clearances, the intersection designator will be used. If ATC omits the intersection designator, call ATC for clarification.

EXAMPLE-

Aircraft: "Cherokee 234AR, Runway 24L at November 4, line up and wait."

h. If landing traffic is a factor during line up and wait operations, ATC will inform the aircraft in position of the closest traffic within 6 flying miles requesting a full-stop, touch-and-go, stop-and-go, or an unrestricted low approach to the same runway. Pilots should take care to note the position of landing traffic. ATC will also advise the landing traffic when an aircraft is authorized to "line up and wait" on the same runway.

EXAMPLE-

Tower: "Cessna 234AR, Runway 24L, line up and wait. Traffic a Boeing 737, six mile final."

Tower: "Delta 1011, continue, traffic a Cessna 210 holding in position Runway 24L."

NOTE-

ATC will normally withhold landing clearance to arrival aircraft when another aircraft is in position and holding on the runway.

i. Never land on a runway that is occupied by another aircraft, even if a landing clearance was issued. Do not hesitate to ask the controller about the traffic on the runway and be prepared to execute a go-around.

NOTE-

Always clarify any misunderstanding or confusion concerning ATC instructions or clearances. ATC should be advised immediately if there is any uncertainty about the ability to comply with any of their instructions.

5-2-6. Abbreviated IFR Departure Clearance (Cleared. . .as Filed) Procedures

a. ATC facilities will issue an abbreviated IFR departure clearance based on the ROUTE of flight filed in the IFR flight plan, provided the filed route can be approved with little or no revision. These abbreviated clearance procedures are based on the following conditions:

1. The aircraft is on the ground or it has departed visual flight rules (VFR) and the pilot is requesting IFR clearance while airborne.

2. That a pilot will not accept an abbreviated clearance if the route or destination of a flight plan filed with ATC has been changed by the pilot or the company or the operations officer before departure.

3. That it is the responsibility of the company or operations office to inform the pilot when they make a change to the filed flight plan.

4. That it is the responsibility of the pilot to inform ATC in the initial call-up (for clearance) when the filed flight plan has been either:

(a) Amended, or

(b) Canceled and replaced with a new filed flight plan.

NOTE-

The facility issuing a clearance may not have received the revised route or the revised flight plan by the time a pilot requests clearance.

b. Controllers will issue a detailed clearance when they know that the original filed flight plan has been changed or when the pilot requests a full route clearance.

c. The clearance as issued will include the destination airport filed in the flight plan.

d. ATC procedures now require the controller to state the DP name, the current number and the DP transition name after the phrase "Cleared to (destination) airport" and prior to the phrase, "then as filed," for ALL departure clearances when the DP or DP transition is to be flown. The procedures apply whether or not the DP is filed in the flight plan.

e. STARs, when filed in a flight plan, are considered a part of the filed route of flight and will not normally be stated in an initial departure clearance. If the ARTCC's jurisdictional airspace includes both the departure airport and the fix where a STAR or STAR transition begins, the STAR name, the current number and the STAR transition name MAY be stated in the initial clearance.

f. "Cleared to (destination) airport as filed" does NOT include the en route altitude filed in a flight plan. An en route altitude will be stated in the clearance or the pilot will be advised to expect an assigned or filed altitude within a given time frame or at a certain point after departure. This may be done verbally in the departure instructions or stated in the DP.

g. In both radar and nonradar environments, the controller will state “Cleared to (destination) airport as filed” or:

1. If a DP or DP transition is to be flown, specify the DP name, the current DP number, the DP transition name, the assigned altitude/flight level, and any additional instructions (departure control frequency, beacon code assignment, etc.) necessary to clear a departing aircraft via the DP or DP transition and the route filed.

EXAMPLE–

National Seven Twenty cleared to Miami Airport Intercontinental one departure, Lake Charles transition then as filed, maintain Flight Level two seven zero.

2. When there is no DP or when the pilot cannot accept a DP, the controller will specify the assigned altitude or flight level, and any additional instructions necessary to clear a departing aircraft via an appropriate departure routing and the route filed.

NOTE–

A detailed departure route description or a radar vector may be used to achieve the desired departure routing.

3. If it is necessary to make a minor revision to the filed route, the controller will specify the assigned DP or DP transition (or departure routing), the revision to the filed route, the assigned altitude or flight level and any additional instructions necessary to clear a departing aircraft.

EXAMPLE–

Jet Star One Four Two Four cleared to Atlanta Airport, South Boston two departure then as filed except change route to read South Boston Victor 20 Greensboro, maintain one seven thousand.

4. Additionally, in a nonradar environment, the controller will specify one or more fixes, as necessary, to identify the initial route of flight.

EXAMPLE–

Cessna Three One Six Zero Foxtrot cleared to Charlotte Airport as filed via Brooke, maintain seven thousand.

h. To ensure success of the program, pilots should:

1. Avoid making changes to a filed flight plan just prior to departure.

2. State the following information in the initial call-up to the facility when no change has been made to the filed flight plan: Aircraft call sign, location, type operation (IFR) and the name of the airport (or fix) to which you expect clearance.

EXAMPLE–

“Washington clearance delivery (or ground control if appropriate) American Seventy Six at gate one, IFR Los Angeles.”

3. If the flight plan has been changed, state the change and request a full route clearance.

EXAMPLE–

“Washington clearance delivery, American Seventy Six at gate one. IFR San Francisco. My flight plan route has been amended (or destination changed). Request full route clearance.”

4. Request verification or clarification from ATC if ANY portion of the clearance is not clearly understood.

5. When requesting clearance for the IFR portion of a VFR/IFR flight, request such clearance prior to the fix where IFR operation is proposed to commence in sufficient time to avoid delay. Use the following phraseology:

EXAMPLE–

“Los Angeles center, Apache Six One Papa, VFR estimating Paso Robles VOR at three two, one thousand five hundred, request IFR to Bakersfield.”

5–2–7. Departure Restrictions, Clearance Void Times, Hold for Release, and Release Times

a. ATC may assign departure restrictions, clearance void times, hold for release, and release times, when necessary, to separate departures from other traffic or to restrict or regulate the departure flow.

1. Clearance Void Times. A pilot may receive a clearance, when operating from an airport without a control tower, which contains a provision for the clearance to be void if not airborne by a specific time. A pilot who does not depart prior to the clearance void time must advise ATC as soon as possible of their intentions. ATC will normally advise the pilot of the time allotted to notify ATC that the aircraft did not depart prior to the clearance void time. This time cannot exceed 30 minutes. Failure of an aircraft to contact ATC within 30 minutes after the clearance void time will result in the aircraft being considered overdue and search and rescue procedures initiated.

NOTE–

1. *Other IFR traffic for the airport where the clearance is issued is suspended until the aircraft has contacted ATC or until 30 minutes after the clearance void time or 30 minutes after the clearance release time if no clearance void time is issued.*

2. Pilots who depart at or after their clearance void time are not afforded IFR separation and may be in violation of 14 CFR Section 91.173 which requires that pilots receive an appropriate ATC clearance before operating IFR in controlled airspace.

EXAMPLE–

Clearance void if not off by (clearance void time) and, if required, if not off by (clearance void time) advise (facility) not later than (time) of intentions.

2. Hold for Release. ATC may issue “hold for release” instructions in a clearance to delay an aircraft’s departure for traffic management reasons (i.e., weather, traffic volume, etc.). When ATC states in the clearance, “hold for release,” the pilot may not depart utilizing that IFR clearance until a release time or additional instructions are issued by ATC. In addition, ATC will include departure delay information in conjunction with “hold for release” instructions. The ATC instruction, “hold for release,” applies to the IFR clearance and does not prevent the pilot from departing under VFR. However, prior to takeoff the pilot should cancel the IFR flight plan and operate the transponder on the appropriate VFR code. An IFR clearance may not be available after departure.

EXAMPLE–

(Aircraft identification) cleared to (destination) airport as filed, maintain (altitude), and, if required (additional instructions or information), hold for release, expect (time in hours and/or minutes) departure delay.

3. Release Times. A “release time” is a departure restriction issued to a pilot by ATC, specifying the earliest time an aircraft may depart. ATC will use “release times” in conjunction with traffic management procedures and/or to separate a departing aircraft from other traffic.

EXAMPLE–

(Aircraft identification) released for departure at (time in hours and/or minutes).

4. Expect Departure Clearance Time (EDCT). The EDCT is the runway release time assigned to an aircraft included in traffic management programs. Aircraft are expected to depart no earlier than 5 minutes before, and no later than 5 minutes after the EDCT.

b. If practical, pilots departing uncontrolled airports should obtain IFR clearances prior to becoming airborne when two-way communications with the controlling ATC facility is available.

5–2–8. Departure Control

a. Departure Control is an approach control function responsible for ensuring separation between departures. So as to expedite the handling of departures, Departure Control may suggest a takeoff direction other than that which may normally have been used under VFR handling. Many times it is preferred to offer the pilot a runway that will require the fewest turns after takeoff to place the pilot on course or selected departure route as quickly as possible. At many locations particular attention is paid to the use of preferential runways for local noise abatement programs, and route departures away from congested areas.

b. Departure Control utilizing radar will normally clear aircraft out of the terminal area using DPs via radio navigation aids.

1. When a departure is to be vectored immediately following takeoff, the pilot will be advised prior to takeoff of the initial heading to be flown but may not be advised of the purpose of the heading. When the initial heading will take the aircraft off an assigned procedure (for example, an RNAV SID with a published lateral path to a waypoint and crossing restrictions from the departure end of runway), the controller will assign an altitude to maintain with the initial heading.

2. At some airports when a departure will fly an RNAV SID that begins at the runway, ATC may advise aircraft of the initial fix/waypoint on the RNAV route. The purpose of the advisory is to remind pilots to verify the correct procedure is programmed in the FMS before takeoff. Pilots must immediately advise ATC if a different RNAV SID is entered in the aircraft’s FMC. When this advisory is absent, pilots are still required to fly the assigned SID as published.

EXAMPLE–

Delta 345 RNAV to MPASS, Runway26L, cleared for takeoff.

NOTE–

1. The SID transition is not restated as it is contained in the ATC clearance.

2. Aircraft cleared via RNAV SIDs designed to begin with a vector to the initial waypoint are assigned a heading before departure.

3. Pilots operating in a radar environment are expected to associate departure headings or an RNAV departure advisory with vectors or the flight path to their planned route or flight. When given a vector

taking the aircraft off a previously assigned nonradar route, the pilot will be advised briefly what the vector is to achieve. Thereafter, radar service will be provided until the aircraft has been reestablished “on-course” using an appropriate navigation aid and the pilot has been advised of the aircraft’s position or a handoff is made to another radar controller with further surveillance capabilities.

c. Controllers will inform pilots of the departure control frequencies and, if appropriate, the transponder code before takeoff. Pilots must ensure their transponder is adjusted to the “on” or normal operating position as soon as practical and remain on during all operations unless otherwise requested to change to “standby” by ATC. Pilots should not change to the departure control frequency until requested. Controllers may omit the departure control frequency if a DP has or will be assigned and the departure control frequency is published on the DP.

5–2–9. Instrument Departure Procedures (DP) – Obstacle Departure Procedures (ODP), Standard Instrument Departures (SID), and Diverse Vector Areas (DVA)

a. Instrument departure procedures are pre-planned instrument flight rule (IFR) procedures which provide obstruction clearance from the terminal area to the appropriate en route structure. There are two types of DPs, Obstacle Departure Procedures (ODP), printed either textually or graphically, and Standard Instrument Departures (SID), always printed graphically. All DPs, either textual or graphic may be designed using either conventional or RNAV criteria. RNAV procedures will have RNAV printed in the title; for example, SHEAD TWO DEPARTURE (RNAV). ODPs provide obstruction clearance via the least onerous route from the terminal area to the appropriate en route structure. ODPs are recommended for obstruction clearance and may be flown without ATC clearance unless an alternate departure procedure (SID or radar vector) has been specifically assigned by ATC. Graphic ODPs will have (OBSTACLE) printed in the procedure title; for example, GEYSR THREE DEPARTURE (OBSTACLE), or, CROWN ONE DEPARTURE (RNAV) (OBSTACLE). Standard Instrument Departures are air traffic control (ATC) procedures printed for pilot/controller use in graphic form to provide obstruction clearance and a

transition from the terminal area to the appropriate en route structure. SIDs are primarily designed for system enhancement and to reduce pilot/controller workload. ATC clearance must be received prior to flying a SID. All DPs provide the pilot with a way to depart the airport and transition to the en route structure safely.

b. A Diverse Vector Area (DVA) is an area in which ATC may provide random radar vectors during an uninterrupted climb from the departure runway until above the MVA/MIA, established in accordance with the TERPS criteria for diverse departures. The DVA provides obstacle and terrain avoidance in lieu of taking off from the runway under IFR using an ODP or SID.

c. Pilots operating under 14 CFR Part 91 are strongly encouraged to file and fly a DP at night, during marginal Visual Meteorological Conditions (VMC) and Instrument Meteorological Conditions (IMC), when one is available. The following paragraphs will provide an overview of the DP program, why DPs are developed, what criteria are used, where to find them, how they are to be flown, and finally pilot and ATC responsibilities.

d. Why are DPs necessary? The primary reason is to provide obstacle clearance protection information to pilots. A secondary reason, at busier airports, is to increase efficiency and reduce communications and departure delays through the use of SIDs. When an instrument approach is initially developed for an airport, the need for DPs is assessed. The procedure designer conducts an obstacle analysis to support departure operations. If an aircraft may turn in any direction from a runway within the limits of the assessment area (see paragraph 5–2–9e3) and remain clear of obstacles, that runway passes what is called a diverse departure assessment and no ODP will be published. A SID may be published if needed for air traffic control purposes. However, if an obstacle penetrates what is called the 40:1 obstacle identification surface, then the procedure designer chooses whether to:

1. Establish a steeper than normal climb gradient; or
2. Establish a steeper than normal climb gradient with an alternative that increases takeoff minima to allow the pilot to visually remain clear of the obstacle(s); or

3. Design and publish a specific departure route;
or
4. A combination or all of the above.
- e. What criteria is used to provide obstruction clearance during departure?

1. Unless specified otherwise, required obstacle clearance for all departures, including diverse, is based on the pilot crossing the departure end of the runway at least 35 feet above the departure end of runway elevation, climbing to 400 feet above the departure end of runway elevation before making the initial turn, and maintaining a minimum climb gradient of 200 feet per nautical mile (FPNM), unless required to level off by a crossing restriction, until the minimum IFR altitude. A greater climb gradient may be specified in the DP to clear obstacles or to achieve an ATC crossing restriction. If an initial turn higher than 400 feet above the departure end of runway elevation is specified in the DP, the turn should be commenced at the higher altitude. If a turn is specified at a fix, the turn must be made at that fix. Fixes may have minimum and/or maximum crossing altitudes that must be adhered to prior to passing the fix. In rare instances, obstacles that exist on the extended runway centerline may make an “early turn” more desirable than proceeding straight ahead. In these cases, the published departure instructions will include the language “turn left(right) as soon as practicable.” These departures will also include a ceiling and visibility minimum of at least 300 and 1. Pilots encountering one of these DPs should preplan the climb out to gain altitude and begin the turn as quickly as possible within the bounds of safe operating practices and operating limitations. This type of departure procedure is being phased out.

NOTE-
“Practical” or “feasible” may exist in some existing departure text instead of “practicable.”

2. ODPs, SIDs, and DVAs assume normal aircraft performance, and that all engines are operating. Development of contingency procedures, required to cover the case of an engine failure or other emergency in flight that may occur after liftoff, is the responsibility of the operator. (More detailed information on this subject is available in Advisory Circular AC 120-91, Airport Obstacle Analysis, and in the “Departure Procedures” section of chapter 2 in the Instrument Procedures Handbook, FAA-H-8083-16.)

3. The 40:1 obstacle identification surface (OIS) begins at the departure end of runway (DER) and slopes upward at 152 FPNM until reaching the minimum IFR altitude or entering the en route structure. This assessment area is limited to 25 NM from the airport in nonmountainous areas and 46 NM in designated mountainous areas. Beyond this distance, the pilot is responsible for obstacle clearance if not operating on a published route, if below (having not reached) the MEA or MOCA of a published route, or an ATC assigned altitude. See FIG 5-2-1. (Ref 14 CFR 91.177 for further information on en route altitudes.)

NOTE-

ODPs are normally designed to terminate within these distance limitations, however, some ODPs will contain routes that may exceed 25/46 NM; these routes will ensure obstacle protection until reaching the end of the ODP.

4. Obstacles that are located within 1 NM of the DER and penetrate the 40:1 OCS are referred to as “low, close-in obstacles.” The standard required obstacle clearance (ROC) of 48 feet per NM to clear these obstacles would require a climb gradient greater than 200 feet per NM for a very short distance, only until the aircraft was 200 feet above the DER. To eliminate publishing an excessive climb gradient, the obstacle AGL/MSL height and location relative to the DER is noted in the “Take-off Minimums and (OBSTACLE) Departure Procedures” section of a given Terminal Procedures Publication (TPP) booklet.

(a) Pilots must refer to the TPP booklet or the Graphic ODP for information on these obstacles. These obstacle notes will no longer be published on SID. Pilots assigned a SID for departure must refer to the airport entry in the TPP to obtain information on these obstacles.

(b) The purpose of noting obstacles in the “Take-off Minimums and (OBSTACLE) Departure Procedures” section of the TPP is to identify the obstacle(s) and alert the pilot to the height and location of the obstacle(s) so they can be avoided. This can be accomplished in a variety of ways; for example, the pilot may be able to see the obstruction and maneuver around the obstacle(s) if necessary; early liftoff/climb performance may allow the aircraft to cross well above the obstacle(s); or if the obstacle(s) cannot be visually acquired during departure, preflight planning should take into account what turns or other maneuver may be necessary immediately after takeoff to avoid the obstruction(s).

FIG 5-2-1
Diverse Departure Obstacle Assessment to 25/46 NM

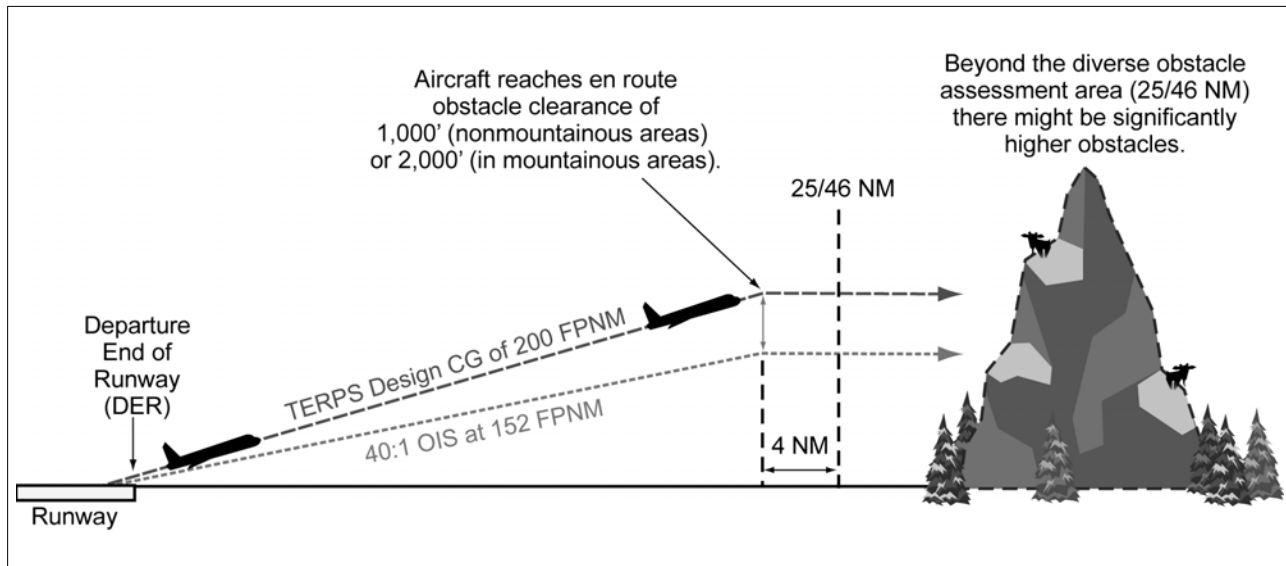

EXAMPLE-

TAKEOFF OBSTACLE NOTES: Rwy 14, trees 2011' from DER, 29' left of centerline, 100' AGL/3829' MSL. Rwy 32, trees 1009' from DER, 697' left of centerline, 100' AGL/3839' MSL. Tower 4448' from DER, 1036' left of centerline, 165' AGL/3886' MSL.

5. Climb gradients greater than 200 FPNM are specified when required to support procedure design constraints, obstacle clearance, and/or airspace restrictions. Compliance with a climb gradient for these purposes is mandatory when the procedure is part of the ATC clearance, unless increased takeoff minimums are provided and weather conditions allow compliance with these minimums.

NOTE-

Climb gradients for ATC purposes are being phased out on SIDs.

EXAMPLE-

“Cross ALPHA intersection at or below 4000; maintain 6000.” The pilot climbs at least 200 FPNM to 6000. If 4000 is reached before ALPHA, the pilot levels off at 4000 until passing ALPHA; then immediately resumes at least 200 FPNM climb.

EXAMPLE-

“TAKEOFF MINIMUMS: RWY 27, Standard with a minimum climb of 280' per NM to 2500.” A climb of at least 280 FPNM is required to 2500 and is mandatory when the departure procedure is included in the ATC clearance.

NOTE-

Some SIDs still retain labeled “ATC” climb gradients published or have climb gradients that are established to

meet a published altitude restriction that is not required for obstacle clearance or procedure design criteria. These procedures will be revised in the course of the normal procedure amendment process.

6. Climb gradients may be specified only to an altitude/fix, above which the normal gradient applies.

An ATC-required altitude restriction published at a fix, will not have an associated climb gradient published with that restriction. Pilots are expected to determine if crossing altitudes can be met, based on the performance capability of the aircraft they are operating.

EXAMPLE-

“Minimum climb 340 FPNM to ALPHA.” The pilot climbs at least 340 FPNM to ALPHA, then at least 200 FPNM to MIA.

7. A Visual Climb Over Airport (VCOA) procedure is a departure option for an IFR aircraft, operating in visual meteorological conditions equal to or greater than the specified visibility and ceiling, to visually conduct climbing turns over the airport to the published “climb-to” altitude from which to proceed with the instrument portion of the departure. VCOA procedures are developed to avoid obstacles greater than 3 statute miles from the departure end of the runway as an alternative to complying with climb gradients greater than 200 feet per nautical mile. Pilots are responsible to advise ATC as early as possible of the intent to fly the VCOA option prior to departure. These textual procedures are published in the Take-Off Minimums and (Obstacle) Departure

Procedures section of the Terminal Procedures Publications and/or appear as an option on a Graphic ODP.

EXAMPLE-

“Climb in visual conditions so as to cross the McElory Airport southbound, at or above 6000, then climb via Keemmling radial zero three three to Keemmling VORTAC.”

f. Who is responsible for obstacle clearance? DPs are designed so that adherence to the procedure by the pilot will ensure obstacle protection. Additionally:

1. Obstacle clearance responsibility also rests with the pilot when he/she chooses to climb in visual conditions in lieu of flying a DP and/or depart under increased takeoff minima rather than fly the climb gradient. Standard takeoff minima are one statute mile for aircraft having two engines or less and one-half statute mile for aircraft having more than two engines. Specified ceiling and visibility minima (VCOA or increased takeoff minima) will allow visual avoidance of obstacles until the pilot enters the standard obstacle protection area. Obstacle avoidance is not guaranteed if the pilot maneuvers farther from the airport than the specified visibility minimum prior to reaching the specified altitude. DPs may also contain what are called Low Close in Obstacles. These obstacles are less than 200 feet above the departure end of runway elevation and within one NM of the runway end, and do not require increased takeoff minima. These obstacles are identified on the SID chart or in the Take-off Minimums and (Obstacle) Departure Procedures section of the U. S. Terminal Procedure booklet. These obstacles are especially critical to aircraft that do not lift off until close to the departure end of the runway or which climb at the minimum rate. Pilots should also consider drift following lift-off to ensure sufficient clearance from these obstacles. That segment of the procedure that requires the pilot to see and avoid obstacles ends when the aircraft crosses the specified point at the required altitude. In all cases continued obstacle clearance is based on having climbed a minimum of 200 feet per nautical mile to the specified point and then continuing to climb at least 200 foot per nautical mile during the departure until reaching the minimum en route altitude, unless specified otherwise.

2. ATC may vector the aircraft beginning with an ATC-assigned heading issued with the initial or

takeoff clearance followed by subsequent vectors, if required, until reaching the minimum vectoring altitude by using a published Diverse Vector Area (DVA).

3. The DVA may be established below the Minimum Vectoring Altitude (MVA) or Minimum IFR Altitude (MIA) in a radar environment at the request of Air Traffic. This type of DP meets the TERPS criteria for diverse departures, obstacles, and terrain avoidance in which random radar vectors below the MVA/MIA may be issued to departing aircraft. The DVA has been assessed for departures which do not follow a specific ground track, but will remain within the specified area. Use of a DVA is valid only when aircraft are permitted to climb uninterrupted from the departure runway to the MVA/MIA (or higher). ATC will not assign an altitude below the MVA/MIA within a DVA.

(a) The existence of a DVA will be noted in the Takeoff Minimums and Obstacle Departure Procedure section of the U.S. Terminal Procedures Publication (TPP). The Takeoff Departure procedure will be listed first, followed by any applicable DVA.

EXAMPLE-

DIVERSE VECTOR AREA (RADAR VECTORS)

AMDT 1 14289 (FAA)

Rwy 6R, headings as assigned by ATC; requires minimum climb of 290' per NM to 400.

Rwys 6L, 7L, 7R, 24R, 25R, headings as assigned by ATC.

(b) Pilots should be aware that a published climb gradient greater than the standard 200 FPNM can exist within a DVA. Pilots should note that the DVA has been assessed for departures which do not follow a specific ground track.

(c) ATC may also vector an aircraft off a previously assigned DP. If the aircraft is airborne and established on a SID or ODP and subsequently vectored off, ATC is responsible for terrain and obstruction clearance. In all cases, the minimum 200 FPNM climb gradient is assumed.

NOTE-

As is always the case, when used by the controller during departure, the term “radar contact” should not be interpreted as relieving pilots of their responsibility to maintain appropriate terrain and obstruction clearance, which may include flying the obstacle DP.

4. Pilots must preplan to determine if the aircraft can meet the climb gradient (expressed in feet per

nautical mile) required by the departure procedure or DVA, and be aware that flying at a higher than anticipated ground speed increases the climb rate requirement in feet per minute. Higher than standard climb gradients are specified by a note on the departure procedure chart for graphic DPs, or in the Take-Off Minimums and (Obstacle) Departure Procedures section of the U.S. Terminal Procedures booklet for textual ODPs. The required climb gradient, or higher, must be maintained to the specified altitude or fix, then the standard climb gradient of 200 ft/NM can be resumed. A table for the conversion of climb gradient (feet per nautical mile) to climb rate (feet per minute), at a given ground speed, is included on the inside of the back cover of the U.S. Terminal Procedures booklets.

g. Where are DPs located? DPs and DVAs will be listed by airport in the IFR Takeoff Minimums and (Obstacle) Departure Procedures Section, Section L, of the Terminal Procedures Publications (TPP). If the DP is textual, it will be described in TPP Section L. SIDs and complex ODPs will be published graphically and named. The name will be listed by airport name and runway in Section L. Graphic ODPs will also have the term “(OBSTACLE)” printed in the charted procedure title, differentiating them from SIDs.

1. An ODP that has been developed solely for obstacle avoidance will be indicated with the symbol “T” on appropriate Instrument Approach Procedure (IAP) charts and DP charts for that airport. The “T” symbol will continue to refer users to TPP Section C. In the case of a graphic ODP, the TPP Section C will only contain the name of the ODP. Since there may be both a textual and a graphic DP, Section C should still be checked for additional information. The nonstandard takeoff minimums and minimum climb gradients found in TPP Section C also apply to charted DPs and radar vector departures unless different minimums are specified on the charted DP. Takeoff minimums and departure procedures apply to all runways unless otherwise specified. New graphic DPs will have all the information printed on the graphic depiction. As a general rule, ATC will only assign an ODP from a nontowered airport when compliance with the ODP is necessary for aircraft to aircraft separation. Pilots may use the ODP to help ensure separation from terrain and obstacles.

h. Responsibilities

1. Each pilot, prior to departing an airport on an IFR flight should:

(a) Consider the type of terrain and other obstacles on or in the vicinity of the departure airport;

(b) Determine whether an ODP is available;

(c) Determine if obstacle avoidance can be maintained visually or if the ODP should be flown; and

(d) Consider the effect of degraded climb performance and the actions to take in the event of an engine loss during the departure. Pilots should notify ATC as soon as possible of reduced climb capability in that circumstance.

NOTE-

Guidance concerning contingency procedures that address an engine failure on takeoff after V_1 speed on a large or turbine-powered transport category airplane may be found in AC 120-91, Airport Obstacle Analysis.

(e) Determine if a DVA is published and whether the aircraft is capable of meeting the published climb gradient. Advise ATC when requesting the IFR clearance, or as soon as possible, if unable to meet the DVA climb gradient.

(f) Check for Takeoff Obstacle Notes published in the TPP for the takeoff runway.

2. Pilots should not exceed a published speed restriction associated with a SID waypoint until passing that waypoint.

3. After an aircraft is established on a SID and subsequently vectored or cleared to deviate off of the SID or SID transition, pilots must consider the SID canceled, unless the controller adds “expect to resume SID;” pilots should then be prepared to rejoin the SID at a subsequent fix or procedure leg. If the SID contains published altitude restrictions, pilots should expect the controller to issue an altitude to maintain. ATC may also interrupt the vertical navigation of a SID and provide alternate altitude instructions while the aircraft remains established on the published lateral path. Aircraft may be vectored off of an ODP, or issued an altitude lower than a published altitude on an ODP, at which time the ODP is canceled and ATC is responsible for terrain and obstacle clearance. In all cases, the minimum 200 FPNM climb gradient is assumed.

4. Aircraft instructed to resume a SID procedure such as a DP or SID which contains speed and/or altitude restrictions, must be:

(a) Issued/reissued all applicable restrictions, or

(b) Advised to “Climb via SID” or resume published speed.

EXAMPLE–

“Resume the Solar One departure, Climb via SID.”

“Proceed direct CIROS, resume the Solar One departure, Climb via SID.”

5. A clearance for a SID which does not contain published crossing restrictions, and/or is a SID with a Radar Vector segment or a Radar Vector SID, will be issued using the phraseology “Maintain (*altitude*).”

6. A clearance for a SID which contains published altitude restrictions may be issued using the phraseology “climb via.” Climb via is an abbreviated clearance that requires compliance with the procedure lateral path, associated speed and altitude restrictions along the cleared route or procedure. Clearance to “climb via” authorizes the pilot to:

(a) When used in the IFR departure clearance, in a PDC, DCL or when cleared to a waypoint depicted on a SID, to join the procedure after departure or to resume the procedure.

(b) When vertical navigation is interrupted and an altitude is assigned to maintain which is not contained on the published procedure, to climb from that previously-assigned altitude at pilot’s discretion to the altitude depicted for the next waypoint.

(c) Once established on the depicted departure, to navigate laterally and climb to meet all published or assigned altitude and speed restrictions.

NOTE–

1. When otherwise cleared along a route or procedure that contains published speed restrictions, the pilot must comply with those speed restrictions independent of a climb via clearance.

2. ATC anticipates pilots will begin adjusting speed the minimum distance necessary prior to a published speed restriction so as to cross the waypoint/fix at the published speed. Once at the published speed ATC expects pilots will maintain the published speed until additional adjustment is required to comply with further published or ATC as-

signed speed restrictions or as required to ensure compliance with 14 CFR Section 91.117.

3. If ATC interrupts lateral/vertical navigation while an aircraft is flying a SID, ATC must ensure obstacle clearance. When issuing a “climb via” clearance to join or resume a procedure ATC must ensure obstacle clearance until the aircraft is established on the lateral and vertical path of the SID.

4. ATC will assign an altitude to cross if no altitude is depicted at a waypoint/fix or when otherwise necessary/required, for an aircraft on a direct route to a waypoint/fix where the SID will be joined or resumed.

5. SIDs will have a “top altitude;” the “top altitude” is the charted “maintain” altitude contained in the procedure description or assigned by ATC.

REFERENCE–

FAA Order JO 7110.65, Paragraph 5-6-2, Methods PCG, Climb Via, Top Altitude

EXAMPLE–

1. Lateral route clearance:

“Cleared Loop Six departure.”

NOTE–

The aircraft must comply with the SID lateral path, and any published speed restrictions.

2. Routing with assigned altitude:

“Cleared Loop Six departure, climb and maintain four thousand.”

NOTE–

The aircraft must comply with the SID lateral path, and any published speed restriction while climbing unrestricted to four thousand.

3. (A pilot filed a flight plan to the Johnston Airport using the Scott One departure, Jonez transition, then Q-145. The pilot filed for FL350. The Scott One includes altitude restrictions, a top altitude and instructions to expect the filed altitude ten minutes after departure). Before departure ATC uses PDC, DCL or clearance delivery to issue the clearance:

“Cleared to Johnston Airport, Scott One departure, Jonez transition, Q-OneForty-five. Climb via SID.”

NOTE–

In Example 3, the aircraft must comply with the Scott One departure lateral path and any published speed and altitude restrictions while climbing to the SID top altitude.

4. (Using the Example 3 flight plan, ATC determines the top altitude must be changed to FL180). The clearance will read:

“Cleared to Johnston Airport, Scott One departure, Jonez transition, Q-One Forty-five, Climb via SID except maintain flight level one eight zero.”

NOTE–

In Example 4, the aircraft must comply with the Scott One

departure lateral path and any published speed and altitude restrictions while climbing to FL180. The aircraft must stop climb at FL180 until issued further clearance by ATC.

5. (An aircraft was issued the Suzan Two departure, “climb via SID” in the IFR departure clearance. After departure ATC must change a waypoint crossing restriction). The clearance will be:

“Climb via SID except cross Mkala at or above seven thousand.”

NOTE–

In Example 5, the aircraft will comply with the Suzan Two departure lateral path and any published speed and altitude restrictions and climb so as to cross Mkala at or above 7,000; remainder of the departure must be flown as published.

6. (An aircraft was issued the Teddd One departure, “climb via SID” in the IFR departure clearance. An interim altitude of 10,000 was issued instead of the published top altitude of FL 230). After departure ATC is able to issue the published top altitude. The clearance will be:

“Climb via SID.”

NOTE–

In Example 6, the aircraft will track laterally and vertically on the Teddd One departure and initially climb to 10,000; Once re-issued the “climb via” clearance the interim altitude is canceled aircraft will continue climb to FL230 while complying with published restrictions.

7. (An aircraft was issued the Bbear Two departure, “climb via SID” in the IFR departure clearance. An interim altitude of 16,000 was issued instead of the published top altitude of FL 190). After departure, ATC is able to issue a top altitude of FL300 and still requires compliance with the published SID restrictions. The clearance will be:

“Climb via SID except maintain flight level three zero zero.”

NOTE–

In Example 7, the aircraft will track laterally and vertically on the Bbear Two departure and initially climb to 16,000; Once re-issued the “climb via” clearance the interim altitude is canceled and the aircraft will continue climb to FL300 while complying with published restrictions.

8. (An aircraft was issued the Bizze Two departure, “climb via SID.” After departure, ATC vectors the aircraft off of the SID, and then issues a direct routing to rejoin the SID at Rockr waypoint which does not have a published altitude restriction. ATC wants the aircraft to cross at or above 10,000). The clearance will read:

“Proceed direct Rockr, cross Rockr at or above one-zero thousand, climb via the Bizze Two departure.”

NOTE–

In Example 8, the aircraft will join the Bizze Two SID at Rockr at or above 10,000 and then comply with the published lateral path and any published speed or altitude restrictions while climbing to the SID top altitude.

9. (An aircraft was issued the Suzan Two departure, “climb via SID” in the IFR departure clearance. After departure ATC vectors the aircraft off of the SID, and then clears the aircraft to rejoin the SID at Dvine waypoint, which has a published crossing restriction). The clearance will read:

“Proceed direct Dvine, Climb via the Suzan Two departure.”

NOTE–

In Example 9, the aircraft will join the Suzan Two departure at Dvine, at the published altitude, and then comply with the published lateral path and any published speed or altitude restrictions.

7. Pilots cleared for vertical navigation using the phraseology “climb via” must inform ATC, upon initial contact, of the altitude leaving and any assigned restrictions not published on the procedure.

EXAMPLE–

1. (Cactus 711 is cleared to climb via the Laura Two departure. The Laura Two has a top altitude of FL190):

“Cactus Seven Eleven leaving two thousand, climbing via the Laura Two departure.”

2. (Cactus 711 is cleared to climb via the Laura Two departure, but ATC changed the top altitude to 16,000):

“Cactus Seven Eleven leaving two thousand for one-six thousand, climbing via the Laura Two departure.”

8. If prior to or after takeoff an altitude restriction is issued by ATC, all previously issued “ATC” altitude restrictions are canceled including those published on a SID. Pilots must still comply with all speed restrictions and lateral path requirements published on the SID unless canceled by ATC.

EXAMPLE–

Prior to takeoff or after departure ATC issues an altitude change clearance to an aircraft cleared to climb via a SID but ATC no longer requires compliance with published altitude restrictions:

“Climb and maintain flight level two four zero.”

NOTE–

The published SID altitude restrictions are canceled; The aircraft should comply with the SID lateral path and begin an unrestricted climb to FL240. Compliance with published speed restrictions is still required unless specifically deleted by ATC.

9. Altitude restrictions published on an ODP are necessary for obstacle clearance and/or design

constraints. Crossing altitudes and speed restrictions on ODPs cannot be canceled or amended by ATC.

i. PBN Departure Procedures

1. All public PBN SIDs and graphic ODPs are normally designed using RNAV 1, RNP 1, or A-RNP NavSpecs. These procedures generally start with an initial track or heading leg near the departure end of runway (DER). In addition, these procedures require system performance currently met by GPS or DME/DME/IRU PBN systems that satisfy the criteria discussed in the latest AC 90-100, U.S. Terminal and En Route Area Navigation (RNAV) Operations. RNAV 1 and RNP 1 procedures must maintain a total

system error of not more than 1 NM for 95 percent of the total flight time. Minimum values for A-RNP procedures will be charted in the PBN box (for example, 1.00 or 0.30).

2. In the U.S., a specific procedure's PBN requirements will be prominently displayed in separate, standardized notes boxes. For procedures with PBN elements, the "PBN box" will contain the procedure's NavSpec(s); and, if required: specific sensors or infrastructure needed for the navigation solution, any additional or advanced functional requirements, the minimum RNP value, and any amplifying remarks. Items listed in this PBN box are REQUIRED for the procedure's PBN elements.

Section 3. En Route Procedures

5-3-1. ARTCC Communications

a. Direct Communications, Controllers and Pilots.

1. ARTCCs are capable of direct communications with IFR air traffic on certain frequencies. Maximum communications coverage is possible through the use of Remote Center Air/Ground (RCAG) sites comprised of both VHF and UHF transmitters and receivers. These sites are located throughout the U.S. Although they may be several hundred miles away from the ARTCC, they are remoted to the various ARTCCs by land lines or microwave links. Since IFR operations are expedited through the use of direct communications, pilots are requested to use these frequencies strictly for communications pertinent to the control of IFR aircraft. Flight plan filing, en route weather, weather forecasts, and similar data should be requested through FSSs, company radio, or appropriate military facilities capable of performing these services.

2. An ARTCC is divided into sectors. Each sector is handled by one or a team of controllers and has its own sector discrete frequency. As a flight progresses from one sector to another, the pilot is requested to change to the appropriate sector discrete frequency.

3. Controller Pilot Data Link Communications (CPDLC) is a system that supplements air/ground voice communications. The CPDLC's principal operating criteria are:

(a) Voice remains the primary and controlling air/ground communications means.

(b) Participating aircraft will need to have the appropriate CPDLC avionics equipment in order to receive uplink or transmit downlink messages.

(c) En Route CPDLC Initial Services offer the following services: Altimeter Setting (AS), Transfer of Communications (TOC), Initial Contact (IC), and limited route assignments, including airborne reroutes (ABRR), limited altitude assignments, and emergency messages.

(1) Altimeter settings will be uplinked automatically when appropriate after a Monitor TOC.

Altimeter settings will also be uplinked automatically when an aircraft receives an uplinked altitude assignment below FL 180. A controller may also manually send an altimeter setting message.

NOTE-

When conducting instrument approach procedures, pilots are responsible to obtain and use the appropriate altimeter setting in accordance with 14 CFR Section 97.20. CPDLC issued altimeter settings are excluded for this purpose.

(2) Initial contact is a safety validation transaction that compares a pilot's initiated altitude downlink message with an aircraft's stored altitude in the ATC automation system. When an IC mismatch or Confirm Assigned Altitude (CAA) downlink time-out indicator is displayed in the Full Data Block (FDB) and Aircraft List (ACL), the controller who has track control of the aircraft must use voice communication to verify the assigned altitude of the aircraft, and acknowledge the IC mismatch/time-out indicator.

(3) Transfer of communications automatically establishes data link contact with a succeeding sector.

(4) Menu text transmissions are scripted nontrajectory altering uplink messages.

(5) The CPDLC Message Elements for the Initial Capabilities rollout are contained in TBL 5-3-1 through TBL 5-3-19, CPDLC Message Elements, below.

NOTE-

The FAA is not implementing ATN B1; the ATN B1 column in the tables is there for informational purposes only.

b. ATC Frequency Change Procedures.

1. The following phraseology will be used by controllers to effect a frequency change:

EXAMPLE-

(Aircraft identification) contact (facility name or location name and terminal function) (frequency) at (time, fix, or altitude).

NOTE-

Pilots are expected to maintain a listening watch on the transferring controller's frequency until the time, fix, or altitude specified. ATC will omit frequency change restrictions whenever pilot compliance is expected upon receipt.

TBL 5-3-1
Route Uplink Message Elements (RTEU)

CPDLC Message Sets			Operational Definition in PANS-ATM (Doc 4444)		
FANS 1/A	ATN B1	Response	Message Element Identifier	Message Element Intended Use	Format for Message Element Display
UM74 PROCEED DIRECT TO <i>(position)</i>	UM74 PROCEED DIRECT TO <i>(position)</i>	W/U	RTEU-2	Instruction to proceed directly to the specified position.	PROCEED DIRECT TO <i>(position)</i>
UM79 CLEARED TO <i>(position)</i> via <i>(route clearance)</i>	UM79 CLEARED TO <i>(position)</i> via <i>(route clearance)</i>	W/U	RTEU-6	Instruction to proceed to the specified position via the specified route.	CLEARED TO <i>(position)</i> VIA <i>(departure data[O])</i> <i>(en-route data)</i>
UM80 CLEARED <i>(route clearance)</i>	UM80 CLEARED <i>(route clearance)</i>	W/U	RTEU-7	Instruction to proceed via the specified route.	CLEARED <i>(departure data[O])</i> <i>(en-route data)</i> <i>(arrival approach data)</i>
UM83 AT <i>(position)</i> CLEARED <i>(route clearance)</i>	N/A	W/U	RTEU-9	Instruction to proceed from the specified position via the specified route.	AT <i>(position)</i> CLEARED <i>(en-route data)</i> <i>(arrival approach data)</i>

TBL 5-3-2
Route Downlink Message Elements (RTED)

CPDLC Message Sets			Operational Definition in PANS-ATM (Doc 4444)		
FANS 1/A	ATN B1	Response	Message Element Identifier	Message Element Intended Use	Format for Message Element Display
DM22 REQUEST DIRECT TO <i>(position)</i>	DM22 REQUEST DIRECT TO <i>(position)</i>	Y	RTED-1	Request for a direct clearance to the specified position.	REQUEST DIRECT TO <i>(position)</i>

TBL 5-3-3

Lateral Downlink Message Elements (LATD)

CPDLC Message Sets			Operational Definition in PANS-ATM (Doc 4444)		
FANS 1/A	ATN B1	Response	Message Element Identifier	Message Element Intended Use	Format for Message Element Display
DM59 DIVERTING TO <i>(position)</i> VIA <i>(route clearance)</i> <i>Note 1. – H alert attribute</i> <i>Note 2. – N response attribute</i>	N/A	N ¹	LATD-5	Report indicating diverting to the specified position via the specified route, which may be sent without any previous coordination done with ATC.	DIVERTING TO <i>(position)</i> VIA <i>(en-route data)</i> <i>(arrival approach data[O])</i>
DM60 OFFSETTING <i>(distance offset)</i> <i>(direction)</i> OF ROUTE <i>Note 1. – H alert attribute</i> <i>Note 2. – N response attribute</i>	N/A	N ¹	LATD-6	Report indicating that the aircraft is offsetting to a parallel track at the specified distance in the specified direction off from the cleared route.	OFFSETTING <i>(specified distance)</i> <i>(direction)</i> OF ROUTE
DM80 DEVIATING <i>(deviation offset)</i> <i>(direction)</i> OF ROUTE <i>Note 1. – H alert attribute</i> <i>Note 2. – N response attribute</i>	N/A	N ¹	LATD-7	Report indicating deviating specified distance or degrees in the specified direction from the cleared route.	DEVIATING <i>(specified Deviation)</i> <i>(direction)</i> OF ROUTE

¹ ICAO Document 10037, Global Operational Data Link (GOLD) Manual has these values set to Y in their table.

TBL 5-3-4

Level Uplink Message Elements (LVLU)

CPDLC Message Sets			Operational Definition in PANS-ATM (Doc 4444)		
FANS 1/A	ATN B1	Response	Message Element Identifier	Message Element Intended Use	Format for Message Element Display
UM19 MAINTAIN <i>(altitude)</i> <i>Note – Used for a single level</i>	UM19 MAINTAIN <i>(level)</i>	W/U	LVLU-5	Instruction to maintain the specified level or vertical range.	MAINTAIN <i>(level)</i>
UM20 CLIMB TO AND MAINTAIN <i>(altitude)</i> <i>Note – Used for a single level</i>	UM20 CLIMB TO <i>(level)</i>	W/U	LVLU-6	Instruction that a climb to the specified level or vertical range is to commence and once reached is to be maintained.	CLIMB TO <i>(level)</i>

CPDLC Message Sets			Operational Definition in PANS-ATM (Doc 4444)		
FANS 1/A	ATN B1	Response	Message Element Identifier	Message Element Intended Use	Format for Message Element Display
UM23 DESCEND TO AND MAINTAIN (altitude) <i>Note – Used for a single level</i>	UM23 DESCEND TO (level)	W/U	LVLU-9	Instruction that a descent to the specified level or vertical range is to commence and once reached is to be maintained.	DESCEND TO (level)
UM36 EXPEDITE CLIMB TO (altitude) <i>Note – This message element is equivalent to SUPU-3 plus LVLU-6 in Doc 4444.</i>	N/A	W/U	LVLU-6	Instruction that a climb to the specified level or vertical range is to commence and once reached is to be maintained.	CLIMB TO (level)
UM37 EXPEDITE DESCEND TO (altitude)	N/A	W/U	LVLU-9	Instruction that a descent to the specified level or vertical range is to commence and once reached is to be maintained.	DESCEND TO (level)
UM38 IMMEDIATELY CLIMB TO (altitude) <i>Note – This message element is equivalent to EMGU-2 plus LVLU-6 in Doc 4444.</i>	N/A	W/U	LVLU-6	Instruction that a climb to the specified level or vertical range is to commence and once reached is to be maintained.	CLIMB TO (level)
UM39 IMMEDIATELY DESCEND TO (altitude) <i>Note – This message element is equivalent to EMGU-2 plus LVLU-9 in Doc 4444.</i>	N/A	W/U	LVLU-9	Instruction that a descent to the specified level or vertical range is to commence and once reached is to be maintained.	DESCEND TO (level)
UM135 CONFIRM ASSIGNED ALTITUDE <i>Note – NE response attribute</i>	N/A	Y	LVLU-27	Request to confirm the assigned level.	CONFIRM ASSIGNED LEVEL
UM177 AT PILOTS DISCRETION	N/A	NE	See Note	Request to confirm the assigned level.	

NOTE–

ICAO Document 10037, *Global Operational Data Link (GOLD) Manual* does not include this in its tables.

TBL 5-3-5
Level Downlink Message Elements (LVLD)

CPDLC Message Sets			Operational Definition in PANS-ATM (Doc 4444)		
FANS 1/A	ATN B1	Response	Message Element Identifier	Message Element Intended Use	Format for Message Element Display
DM6 REQUEST (<i>altitude</i>) <i>Note – Used for a single level</i>	DM6 REQUEST (<i>level</i>)	Y	LVLD-1	Request to fly at the specified level or vertical range.	REQUEST (<i>level</i>)
DM9 REQUEST CLIMB TO (<i>altitude</i>)	DM9 REQUEST CLIMB TO (<i>level</i>)	Y	LVLD-2	Request for a climb to the specified level or vertical range.	REQUEST CLIMB TO (<i>level</i>)
DM10 REQUEST DESCENT TO (<i>altitude</i>)	DM10 REQUEST DESCENT TO (<i>level</i>)	Y	LVLD-3	Request for a descent to the specified level or vertical range.	REQUEST DESCENT TO (<i>level</i>)
DM38 ASSIGNED LEVEL (<i>altitude</i>) <i>Note – Used for a single level</i>	DM38 ASSIGNED LEVEL (<i>level</i>)	N	LVLD-11	Confirmation that the assigned level or vertical range is the specified level or vertical range.	ASSIGNED LEVEL (<i>level</i>)
DM61 DESCENDING TO (<i>altitude</i>) <i>Note – urgent alert attribute</i>	N/A	N	LVLD-14	Report indicating descending to the specified level.	DESCENDING TO (<i>level single</i>)

TBL 5-3-6

Crossing Constraint Message Elements (CSTU)

CPDLC Message Sets			Operational Definition in PANS-ATM (Doc 4444)		
FANS 1/A	ATN B1	Response	Message Element Identifier	Message Element Intended Use	Format for Message Element Display
UM49 CROSS (<i>position</i>) AT AND MAINTAIN (<i>altitude</i>) <i>Note 1. – A vertical range cannot be provided.</i> <i>Note 2. – This message element is equivalent to CSTU-1 plus LVLU-5 in Doc 4444.</i>	N/A	W/U	CSTU-1	Instruction that the specified position is to be crossed at the specified level or within the specified vertical range.	CROSS (<i>position</i>) AT (<i>level</i>)
UM61 CROSS (<i>position</i>) AT AND MAINTAIN (<i>altitude</i>) AT (<i>speed</i>) <i>Note 1. – A vertical range cannot be provided.</i> <i>Note 2. – This message element is equivalent to CSTU-14 plus LVLU-5 in Doc 4444.</i>	UM61 CROSS (<i>position</i>) AT AND MAINTAIN (<i>level</i>) AT (<i>speed</i>)	W/U	CSTU-14	Instruction that the specified position is to be crossed at the level or within the vertical range, as specified, and at the specified speed.	CROSS (<i>position</i>) AT (<i>level</i>) AT (<i>speed</i>)

TBL 5-3-7

Air Traffic Advisory Uplink Message Elements

CPDLC Message Sets			Operational Definition in PANS-ATM (Doc 4444)		
FANS 1/A	ATN B1	Response	Message Element Identifier	Message Element Intended Use	Format for Message Element Display
UM153 ALTIMETER (<i>altimeter</i>) <i>Note – The facility designation and the time of measurement cannot be provided.</i>	UM213 (<i>facility designation</i>) ALTIMETER (<i>altimeter</i>) <i>Note – The facility designation is always provided and the time of measurement cannot be provided.</i>	ADVU-1	Advisory providing the specified altimeter setting for the specified facility.	(<i>facility designation</i>) ALTIMETER (<i>altimeter setting</i>)	ADVU-1

TBL 5-3-8

Voice Communications Uplink Message Elements (COMU)

CPDLC Message Sets			Operational Definition in PANS-ATM (Doc 4444)		
FANS 1/A	ATN B1	Response	Message Element Identifier	Message Element Intended Use	Format for Message Element Display
UM117 CONTACT (ICAO unit name) (frequency)	UM117 CONTACT (unit name) (frequency)	W/U	COMU-1	Instruction to establish voice contact with the specified ATS unit on the specified frequency.	CONTACT (unit name) (frequency)
UM120 MONITOR (ICAO unit name) (frequency)	UM120 MONITOR (unit name) (frequency)	W/U	COMU-5	Instruction to monitor the specified ATS unit on the specified frequency. The flight crew is not required to establish voice contact on the frequency.	MONITOR (unit name) (frequency)

TBL 5-3-9

Voice Communications Downlink Message Elements (COMD)

CPDLC Message Sets			Operational Definition in PANS-ATM (Doc 4444)		
FANS 1/A	ATN B1	Response	Message Element Identifier	Message Element Intended Use	Format for Message Element Display
DM20 REQUEST VOICE CONTACT <i>Note – Used when a frequency is not required.</i>	N/A	Y	COMD-1	Request for voice contact on the specified frequency.	REQUEST VOICE CONTACT (frequency)

TBL 5-3-10

Emergency/Urgency Uplink Message Elements (EMGU)

CPDLC Message Sets			Operational Definition in PANS-ATM (Doc 4444)		
FANS 1/A	ATN B1	Response	Message Element Identifier	Message Element Intended Use	Format for Message Element Display
Used in combination with LVLU-6 and LVLU-9, which is implemented in FANS 1/A as: UM38 IMMEDIATELY CLIMB TO (altitude) UM39 IMMEDIATELY DESCEND TO (altitude)	N/A	N	EMGU-2	Instruction to immediately comply with the associated instruction to avoid imminent situation.	Immediately

TBL 5-3-11
Emergency/Urgency Downlink Message Elements (EMGD)

CPDLC Message Sets			Operational Definition in PANS-ATM (Doc 4444)		
FANS 1/A	ATN B1	Response	Message Element Identifier	Message Element Intended Use	Format for Message Element Display
DM55 PAN PAN PAN <i>Note – N response attribute</i>	N/A	Y	EMGD-1	Indication of an urgent situation.	PAN PAN PAN
DM56 MAYDAY MAYDAY MAYDAY <i>Note – N response attribute</i>	N/A	Y	EMGD-2	Indication of an emergency situation.	MAYDAY MAYDAY MAYDAY
DM57 (<i>remaining fuel</i>) OF FUEL REMAINING AND (<i>remaining souls</i>) SOULS ON BOARD <i>Note – N response attribute</i>	N/A	Y	EMGD-3	Report indicating fuel remaining (time) and number of persons on board.	(<i>remaining fuel</i>) ENDURANCE AND (<i>persons on board</i>) PERSONS ON BOARD
DM58 CANCEL EMERGENCY <i>Note – N response attribute</i>	N/A	Y	EMGD-4	Indication that the emergency situation is canceled.	CANCEL EMERGENCY

TBL 5-3-12
Standard Response Uplink Message Elements (RSPU)

CPDLC Message Sets			Operational Definition in PANS-ATM (Doc 4444)		
FANS 1/A	ATN B1	Response	Message Element Identifier	Message Element Intended Use	Format for Message Element Display
UM0 UNABLE	UM0 UNABLE	N	RSPU-1	Indication that the message cannot be complied with.	UNABLE
UM1 STANDBY	UM1 STANDBY	N	RSPU-2	Indication that the message will be responded to shortly.	STANDBY
UM3 ROGER	UM3 ROGER	N	RSPU-4	Indication that the message is received.	ROGER

TBL 5-3-13

Standard Response Downlink Message Elements (RSPD)

CPDLC Message Sets			Operational Definition in PANS-ATM (Doc 4444)		
FANS 1/A	ATN B1	Response	Message Element Identifier	Message Element Intended Use	Format for Message Element Display
DM0 WILCO	DM0 WILCO	N	RSPD-1	Indication that the instruction is understood and will be complied with.	WILCO
DM1 UNABLE	DM1 UNABLE	N	RSPD-2	Indication that the message cannot be complied with.	UNABLE
DM2 STANDBY	DM2 STANDBY	N	RSPD-3	Indication that the message will be responded to shortly.	STANDBY
DM3 ROGER <i>Note – ROGER is the only correct response to an uplink free text message.</i>	DM3 ROGER	N	RSPD-4	Indication that the message is received.	ROGER

TBL 5-3-14

Supplemental Uplink Message Elements (SUPU)

CPDLC Message Sets			Operational Definition in PANS-ATM (Doc 4444)		
FANS 1/A	ATN B1	Response	Message Element Identifier	Message Element Intended Use	Format for Message Element Display
UM166 DUE TO TRAFFIC	N/A	N	SUPU-2	Indication that the associated message is issued due to the specified reason.	DUE TO <i>(specified reason uplink)</i>
UM167 DUE TO AIRSPACE RESTRICTION					

TBL 5-3-15

Supplemental Downlink Message Elements (SUPD)

CPDLC Message Sets			Operational Definition in PANS-ATM (Doc 4444)		
FANS 1/A	ATN B1	Response	Message Element Identifier	Message Element Intended Use	Format for Message Element Display
DM65 DUE TO WEATHER	DM65 DUE TO WEATHER	N	SUPD-1	Indication that the associated message is issued due to the specified reason.	DUE TO <i>(specified reason downlink)</i>
DM66 DUE TO AIRCRAFT PERFORMANCE	DM66 DUE TO AIRCRAFT PERFORMANCE				

TBL 5-3-16
Free Text Uplink Message Elements (TXTU)

CPDLC Message Sets			Operational Definition in PANS-ATM (Doc 4444)		
FANS 1/A	ATN B1	Response	Message Element Identifier	Message Element Intended Use	Format for Message Element Display
UM169 (free text)	UM203 (free text)	R	TXTU-1		(free text) Note – M alert attribute.
UM169 (free text) CPDLC NOT IN USE UNTIL FURTHER NOTIFICATION	N/A	R	See Note		(free text)
UM169 (free text) “[facility designation]” (for Altimeter Reporting Station)	N/A	R	See Note		(free text)
UM169 (free text) “[facility designation] ALTIMETER MORE THAN ONE HOUR” OLD	N/A	R	See Note		(free text)
UM169 (free text) DUE TO WEATHER	N/A	R	See Note		(free text)
UM169 (free text) REST OF ROUTE UN- CHANGED	N/A	R	See Note		(free text)
UM169 (free text) TRAFFIC FLOW MANAGEMENT REROUTE	N/A	R	See Note		(free text)

NOTE-
 These are FAA scripted free text messages with no GOLD equivalent.

TBL 5-3-17
Free Text Downlink Message Elements (TXTD)

CPDLC Message Sets			Operational Definition in PANS-ATM (Doc 4444)		
FANS 1/A	ATN B1	Response	Message Element Identifier	Message Element Intended Use	Format for Message Element Display
DM68 (free text) Note 1. – Urgency or Distress Alr (M) Note 2. – Selecting any of the emergency message elements will result in this message ele- ment being enabled for the flight crew to include in the emergency message at their discretion.	N/A	Y	TXTD-1		(free text) Note – M alert attribute.

TBL 5-3-18

System Management Uplink Message Elements (SYSU)

CPDLC Message Sets			Operational Definition in PANS-ATM (Doc 4444)		
FANS 1/A	ATN B1	Response	Message Element Identifier	Message Element Intended Use	Format for Message Element Display
UM159 ERROR (<i>error information</i>)	UM159 ERROR (<i>error information</i>)	N	SYSU-1	System-generated notification of an error.	ERROR (<i>error information</i>)
UM160 NEXT DATA AUTHORITY (<i>ICAO facility designation</i>) <i>Note – The facility designation is required.</i>	UM160 NEXT DATA AUTHORITY (<i>facility</i>) <i>Note – Facility parameter can specify a facility designation or no facility.</i>	N	SYSU-2	System-generated notification of the next data authority or the cancellation thereof.	NEXT DATA AUTHORITY (<i>facility designation [O]</i>)

TBL 5-3-19

System Management Downlink Message Elements (SYSD)

CPDLC Message Sets			Operational Definition in PANS-ATM (Doc 4444)		
FANS 1/A	ATN B1	Response	Message Element Identifier	Message Element Intended Use	Format for Message Element Display
DM62 ERROR (<i>error information</i>)	DM62 ERROR (<i>error information</i>)	N	SYSD-1	System-generated notification of an error.	SYSD-1
DM63 NOT CURRENT DATA AUTHORITY	DM63 NOT CURRENT DATA AUTHORITY	N	SYSD-3	System-generated rejection of any CPDLC message sent from a ground facility that is not the current data authority.	SYSD-3
DM64 (<i>ICAO facility designation</i>) <i>Note – Use by FANS 1/A aircraft in B1 environments.</i>	DM107 NOT AUTHORIZED NEXT DATA AUTHORITY <i>Note – CDA and NDA cannot be provided.</i>	N	SYSD-5	System-generated notification that the ground system is not designated as the next data authority (NDA), indicating the identity of the current data authority (CDA). Identity of the NDA, if any, is also reported.	SYSD-5

2. The following phraseology should be utilized by pilots for establishing contact with the designated facility:

(a) When operating in a radar environment: On initial contact, the pilot should inform the controller of the aircraft's assigned altitude preceded by the words "level," or "climbing to," or "descending to," as appropriate; and the aircraft's present vacating altitude, if applicable.

EXAMPLE-

1. (Name) CENTER, (aircraft identification), LEVEL (altitude or flight level).

2. (Name) CENTER, (aircraft identification), LEAVING (exact altitude or flight level), CLIMBING TO OR DESCENDING TO (altitude of flight level).

NOTE-

Exact altitude or flight level means to the nearest 100 foot increment. Exact altitude or flight level reports on initial contact provide ATC with information required prior to using Mode C altitude information for separation purposes.

(b) When operating in a nonradar environment:

(1) On initial contact, the pilot should inform the controller of the aircraft's present position, altitude and time estimate for the next reporting point.

EXAMPLE-

(Name) CENTER, (aircraft identification), (position), (altitude), ESTIMATING (reporting point) AT (time).

(2) After initial contact, when a position report will be made, the pilot should give the controller a complete position report.

EXAMPLE-

(Name) CENTER, (aircraft identification), (position), (time), (altitude), (type of flight plan), (ETA and name of next reporting point), (the name of the next succeeding reporting point), AND (remarks).

REFERENCE-

AIM, Paragraph 5-3-2, Position Reporting

3. At times controllers will ask pilots to verify that they are at a particular altitude. The phraseology used will be: "VERIFY AT (altitude)." In climbing or descending situations, controllers may ask pilots to "VERIFY ASSIGNED ALTITUDE AS (altitude)." Pilots should confirm that they are at the altitude

stated by the controller or that the assigned altitude is correct as stated. If this is not the case, they should inform the controller of the actual altitude being maintained or the different assigned altitude.

CAUTION-

Pilots should not take action to change their actual altitude or different assigned altitude to the altitude stated in the controllers verification request unless the controller specifically authorizes a change.

c. **ARTCC Radio Frequency Outage.** ARTCCs normally have at least one back-up radio receiver and transmitter system for each frequency, which can usually be placed into service quickly with little or no disruption of ATC service. Occasionally, technical problems may cause a delay but switchover seldom takes more than 60 seconds. When it appears that the outage will not be quickly remedied, the ARTCC will usually request a nearby aircraft, if there is one, to switch to the affected frequency to broadcast communications instructions. It is important, therefore, that the pilot wait at least 1 minute before deciding that the ARTCC has actually experienced a radio frequency failure. When such an outage does occur, the pilot should, if workload and equipment capability permit, maintain a listening watch on the affected frequency while attempting to comply with the following recommended communications procedures:

1. If two-way communications cannot be established with the ARTCC after changing frequencies, a pilot should attempt to recontact the transferring controller for the assignment of an alternative frequency or other instructions.

2. When an ARTCC radio frequency failure occurs after two-way communications have been established, the pilot should attempt to reestablish contact with the center on any other known ARTCC frequency, preferably that of the next responsible sector when practicable, and ask for instructions. However, when the next normal frequency change along the route is known to involve another ATC facility, the pilot should contact that facility, if feasible, for instructions. If communications cannot be reestablished by either method, the pilot is expected to request communications instructions from the FSS appropriate to the route of flight.

NOTE—

The exchange of information between an aircraft and an ARTCC through an FSS is quicker than relay via company radio because the FSS has direct interphone lines to the responsible ARTCC sector. Accordingly, when circumstances dictate a choice between the two, during an ARTCC frequency outage, relay via FSS radio is recommended.

d. Oakland Oceanic FIR. The use of CPDLC and ADS-C in the Oakland Oceanic FIR (KZAK) is only permitted by Inmarsat, Iridium, and MTSAT customers. All other forms of data link connectivity are not authorized. Users must ensure that the proper data link code is filed in Item 10a of the ICAO FPL in order to indicate which satellite medium(s) the aircraft is equipped with. The identifier for Inmarsat is J5, the identifier for MTSAT is J6, and the identifier for Iridium is J7. If J5, J6, or J7 is not included in the ICAO FPL, then the LOGON will be rejected by KZAK and the aircraft will not be able to connect.

e. New York Oceanic FIR. The use of CPDLC and ADS-C in the New York Oceanic FIR (KZWY) is only permitted by Inmarsat and Iridium customers. All other forms of data link connectivity are not authorized. Users must ensure that the proper data link code is filed in Item 10a of the ICAO FPL in order to indicate which satellite medium(s) the aircraft is equipped with. The identifier for Inmarsat is J5 and the identifier for Iridium is J7. If J5 or J7 is not included in the ICAO FPL, then the LOGON will be rejected by KZWY and the aircraft will not be able to connect.

5-3-2. Position Reporting

The safety and effectiveness of traffic control depends to a large extent on accurate position reporting. In order to provide the proper separation and expedite aircraft movements, ATC must be able to make accurate estimates of the progress of every aircraft operating on an IFR flight plan.

a. Position Identification.

1. When a position report is to be made passing a VOR radio facility, the time reported should be the time at which the first complete reversal of the “to/from” indicator is accomplished.



2. When a position report is made passing a facility by means of an airborne ADF, the time

reported should be the time at which the indicator makes a complete reversal.

3. When an aural or a light panel indication is used to determine the time passing a reporting point, such as a fan marker, Z marker, cone of silence or intersection of range courses, the time should be noted when the signal is first received and again when it ceases. The mean of these two times should then be taken as the actual time over the fix.

4. If a position is given with respect to distance and direction from a reporting point, the distance and direction should be computed as accurately as possible.

5. Except for terminal area transition purposes, position reports or navigation with reference to aids not established for use in the structure in which flight is being conducted will not normally be required by ATC.

b. Position Reporting Points. CFRs require pilots to maintain a listening watch on the appropriate frequency and, unless operating under the provisions of subparagraph c, to furnish position reports passing certain reporting points. Reporting points are indicated by symbols on en route charts. The designated compulsory reporting point symbol is a solid triangle  and the “on request” reporting point symbol is the open triangle . Reports passing an “on request” reporting point are only necessary when requested by ATC.

c. Position Reporting Requirements.

1. Flights Along Airways or Routes. A position report is required by all flights regardless of altitude, including those operating in accordance with an ATC clearance specifying “VFR-on-top,” over each designated compulsory reporting point along the route being flown.

2. Flights Along a Direct Route. Regardless of the altitude or flight level being flown, including flights operating in accordance with an ATC clearance specifying “VFR-on-top,” pilots must report over each reporting point used in the flight plan to define the route of flight.

3. Flights in a Radar Environment. When informed by ATC that their aircraft are in “Radar Contact,” pilots should discontinue position reports over designated reporting points. They should resume normal position reporting when ATC advises

“RADAR CONTACT LOST” or “RADAR SERVICE TERMINATED.”

4. Flights in an Oceanic (Non-radar) Environment. Pilots must report over each point used in the flight plan to define the route of flight, even if the point is depicted on aeronautical charts as an “on request” (non-compulsory) reporting point. For aircraft providing automatic position reporting via an Automatic Dependent Surveillance-Contract (ADS-C) logon, pilots should discontinue voice position reports.

NOTE—

ATC will inform pilots that they are in “radar contact”:

(a) when their aircraft is initially identified in the ATC system; and

(b) when radar identification is reestablished after radar service has been terminated or radar contact lost. Subsequent to being advised that the controller has established radar contact, this fact will not be repeated to the pilot when handed off to another controller. At times, the aircraft identity will be confirmed by the receiving controller; however, this should not be construed to mean that radar contact has been lost. The identity of transponder equipped aircraft will be confirmed by asking the pilot to “ident,” “squawk standby,” or to change codes. Aircraft without transponders will be advised of their position to confirm identity. In this case, the pilot is expected to advise the controller if in disagreement with the position given. Any pilot who cannot confirm the accuracy of the position given because of not being tuned to the NAVAID referenced by the controller, should ask for another radar position relative to the tuned in NAVAID.

d. Position Report Items:

1. Position reports should include the following items:

- (a) Identification;
- (b) Position;
- (c) Time;
- (d) Altitude or flight level (include actual altitude or flight level when operating on a clearance specifying VFR-on-top);
- (e) Type of flight plan (not required in IFR position reports made directly to ARTCCs or approach control);
- (f) ETA and name of next reporting point;
- (g) The name only of the next succeeding reporting point along the route of flight; and

- (h) Pertinent remarks.

5-3-3. Additional Reports

a. The following reports should be made to ATC or FSS facilities without a specific ATC request:

1. At all times.

(a) When vacating any previously assigned altitude or flight level for a newly assigned altitude or flight level.

(b) When an altitude change will be made if operating on a clearance specifying VFR-on-top.

(c) When *unable* to climb/descend at a rate of a least 500 feet per minute.

(d) When approach has been missed. (Request clearance for specific action; i.e., to alternative airport, another approach, etc.)

(e) Change in the average true airspeed (at cruising altitude) when it varies by 5 percent or 10 knots (whichever is greater) from that filed in the flight plan.

(f) The time and altitude or flight level upon reaching a holding fix or point to which cleared.

(g) When leaving any assigned holding fix or point.

NOTE—

The reports in subparagraphs (f) and (g) may be omitted by pilots of aircraft involved in instrument training at military terminal area facilities when radar service is being provided.

(h) Any loss, in controlled airspace, of VOR, TACAN, ADF, low frequency navigation receiver capability, GPS anomalies while using installed IFR-certified GPS/GNSS receivers, complete or partial loss of ILS receiver capability or impairment of air/ground communications capability. Reports should include aircraft identification, equipment affected, degree to which the capability to operate under IFR in the ATC system is impaired, and the nature and extent of assistance desired from ATC.

NOTE—

1. *Other equipment installed in an aircraft may effectively impair safety and/or the ability to operate under IFR. If such equipment (e.g., airborne weather radar) malfunctions and in the pilot’s judgment either safety or IFR capabilities are affected, reports should be made as above.*

2. *When reporting GPS anomalies, include the location and altitude of the anomaly. Be specific when describing*

the location and include duration of the anomaly if necessary.

(i) Any information relating to the safety of flight.

2. When not in radar contact.

(a) When leaving final approach fix inbound on final approach (nonprecision approach) or when leaving the outer marker or fix used in lieu of the outer marker inbound on final approach (precision approach).

(b) A corrected estimate at anytime it becomes apparent that an estimate as previously submitted is in error in excess of 2 minutes. For flights in the North Atlantic (NAT), a revised estimate is required if the error is 3 minutes or more.

b. Pilots encountering weather conditions which have not been forecast, or hazardous conditions which have been forecast, are expected to forward a report of such weather to ATC.

REFERENCE-

AIM, Paragraph 7-1-20, Pilot Weather Reports (PIREPs)
14 CFR Section 91.183(B) and (C).

5-3-4. Airways and Route Systems

a. Three fixed route systems are established for air navigation purposes. They are the Federal airway system (consisting of VOR and L/MF routes), the jet route system, and the RNAV route system. To the extent possible, these route systems are aligned in an overlying manner to facilitate transition between each.

1. The VOR and L/MF (nondirectional radio beacons) Airway System consists of airways designated from 1,200 feet above the surface (or in some instances higher) up to but not including 18,000 feet MSL. These airways are depicted on IFR Enroute Low Altitude Charts.

NOTE-

The altitude limits of a victor airway should not be exceeded except to effect transition within or between route structures.

(a) Except in Alaska, the VOR airways are: predicated solely on VOR or VORTAC navigation aids; depicted in black on aeronautical charts; and identified by a "V" (Victor) followed by the airway number (for example, V12).

NOTE-

Segments of VOR airways in Alaska are based on L/MF navigation aids and charted in brown instead of black on en route charts.

(1) A segment of an airway which is common to two or more routes carries the numbers of all the airways which coincide for that segment. When such is the case, pilots filing a flight plan need to indicate only that airway number for the route filed.

NOTE-

A pilot who intends to make an airway flight, using VOR facilities, will simply specify the appropriate "victor" airway(s) in the flight plan. For example, if a flight is to be made from Chicago to New Orleans at 8,000 feet, using omniranges only, the route may be indicated as "departing from Chicago-Midway, cruising 8,000 feet via Victor 9 to Moisant International." If flight is to be conducted in part by means of L/MF navigation aids and in part on omniranges, specifications of the appropriate airways in the flight plan will indicate which types of facilities will be used along the described routes, and, for IFR flight, permit ATC to issue a traffic clearance accordingly. A route may also be described by specifying the station over which the flight will pass, but in this case since many VORs and L/MF aids have the same name, the pilot must be careful to indicate which aid will be used at a particular location. This will be indicated in the route of flight portion of the flight plan by specifying the type of facility to be used after the location name in the following manner: Newark L/MF; Allentown VOR.

(2) With respect to position reporting, reporting points are designated for VOR Airway Systems. Flights using Victor Airways will report over these points unless advised otherwise by ATC.

(b) The L/MF airways (colored airways) are predicated solely on L/MF navigation aids and are depicted in brown on aeronautical charts and are identified by color name and number (e.g., Amber One). Green and Red airways are plotted east and west. Amber and Blue airways are plotted north and south.

NOTE-

Except for G13 in North Carolina, the colored airway system exists only in the state of Alaska. All other such airways formerly so designated in the conterminous U.S. have been rescinded.

(c) The use of TSO-C145 (as revised) or TSO-C146 (as revised) GPS/WAAS navigation systems is allowed in Alaska as the only means of navigation on published air traffic service (ATS) routes, including those Victor, T-Routes, and colored airway segments designated with a second minimum

en route altitude (MEA) depicted in blue and followed by the letter G at those lower altitudes. The altitudes so depicted are below the minimum reception altitude (MRA) of the land-based navigation facility defining the route segment, and guarantee standard en route obstacle clearance and two-way communications. Air carrier operators requiring operations specifications are authorized to conduct operations on those routes in accordance with FAA operations specifications.

2. The jet route system consists of jet routes established from 18,000 feet MSL to FL 450 inclusive.

(a) These routes are depicted on Enroute High Altitude Charts. Jet routes are depicted in black on aeronautical charts and are identified by a “J” (Jet) followed by the airway number (e.g., J12). Jet routes, as VOR airways, are predicated solely on VOR or VORTAC navigation facilities (except in Alaska).

NOTE–

Segments of jet routes in Alaska are based on L/MF navigation aids and are charted in brown color instead of black on en route charts.

(b) With respect to position reporting, reporting points are designated for jet route systems. Flights using jet routes will report over these points unless otherwise advised by ATC.

3. Area Navigation (RNAV) Routes.

(a) Published RNAV routes, including Q-Routes and T-Routes, can be flight planned for use by aircraft with RNAV capability, subject to any limitations or requirements noted on en route charts, in applicable Advisory Circulars, or by NOTAM. RNAV routes are depicted in blue on aeronautical charts and are identified by the letter “Q” or “T” followed by the airway number (for example, Q-13, T-205). Published RNAV routes are RNAV-2 except when specifically charted as RNAV-1. These routes require system performance currently met by GPS, GPS/WAAS, or DME/DME/IRU RNAV systems that satisfy the criteria discussed in AC 90-100A, U.S. Terminal and En Route Area Navigation (RNAV) Operations.

(1) Q-routes are available for use by RNAV equipped aircraft between 18,000 feet MSL and FL 450 inclusive. Q-routes are depicted on Enroute High Altitude Charts.

NOTE–

Aircraft in Alaska may only operate on GNSS Q-routes with GPS (TSO-C129 (as revised) or TSO-C196 (as revised)) equipment while the aircraft remains in Air Traffic Control (ATC) radar surveillance or with GPS/WAAS which does not require ATC radar surveillance.

(2) T-routes are available for use by GPS or GPS/WAAS equipped aircraft from 1,200 feet above the surface (or in some instances higher) up to but not including 18,000 feet MSL. T-routes are depicted on Enroute Low Altitude Charts.

NOTE–

Aircraft in Alaska may only operate on GNSS T-routes with GPS/WAAS (TSO-C145 (as revised) or TSO-C146 (as revised)) equipment.

(b) Unpublished RNAV routes are direct routes, based on area navigation capability, between waypoints defined in terms of latitude/longitude coordinates, degree-distance fixes, or offsets from established routes/airways at a specified distance and direction. Radar monitoring by ATC is required on all unpublished RNAV routes, except for GNSS-equipped aircraft cleared via filed published waypoints recallable from the aircraft’s navigation database.

(c) Magnetic Reference Bearing (MRB) is the published bearing between two waypoints on an RNAV/GPS/GNSS route. The MRB is calculated by applying magnetic variation at the waypoint to the calculated true course between two waypoints. The MRB enhances situational awareness by indicating a reference bearing (no-wind heading) that a pilot should see on the compass/HSI/RMI, etc., when turning prior to/over a waypoint en route to another waypoint. Pilots should use this bearing as a reference only, because their RNAV/GPS/GNSS navigation system will fly the true course between the waypoints.

b. Operation above FL 450 may be conducted on a point-to-point basis. Navigational guidance is provided on an area basis utilizing those facilities depicted on the enroute high altitude charts.

c. Radar Vectors. Controllers may vector aircraft within controlled airspace for separation purposes, noise abatement considerations, when an operational advantage will be realized by the pilot or the controller, or when requested by the pilot. Vectors outside of controlled airspace will be provided only on pilot request. Pilots will be advised as to what the vector is to achieve when the vector is controller initiated and will take the aircraft off a previously assigned nonradar route. To the extent possible, aircraft operating on RNAV routes will be allowed to remain on their own navigation.

d. When flying in Canadian airspace, pilots are cautioned to review Canadian Air Regulations.

1. Special attention should be given to the parts which differ from U.S. CFRs.

(a) The Canadian Airways Class B airspace restriction is an example. Class B airspace is all controlled low level airspace above 12,500 feet MSL

or the MEA, whichever is higher, within which only IFR and controlled VFR flights are permitted. (Low level airspace means an airspace designated and defined as such in the Designated Airspace Handbook.)

(b) Unless issued a VFR flight clearance by ATC, regardless of the weather conditions or the height of the terrain, no person may operate an aircraft under VMC within Class B airspace.

(c) The requirement for entry into Class B airspace is a student pilot permit (under the guidance or control of a flight instructor).

(d) VFR flight requires visual contact with the ground or water at all times.

2. Segments of VOR airways and high level routes in Canada are based on L/MF navigation aids and are charted in brown color instead of blue on en route charts.

**FIG 5-3-1
Adhering to Airways or Routes**

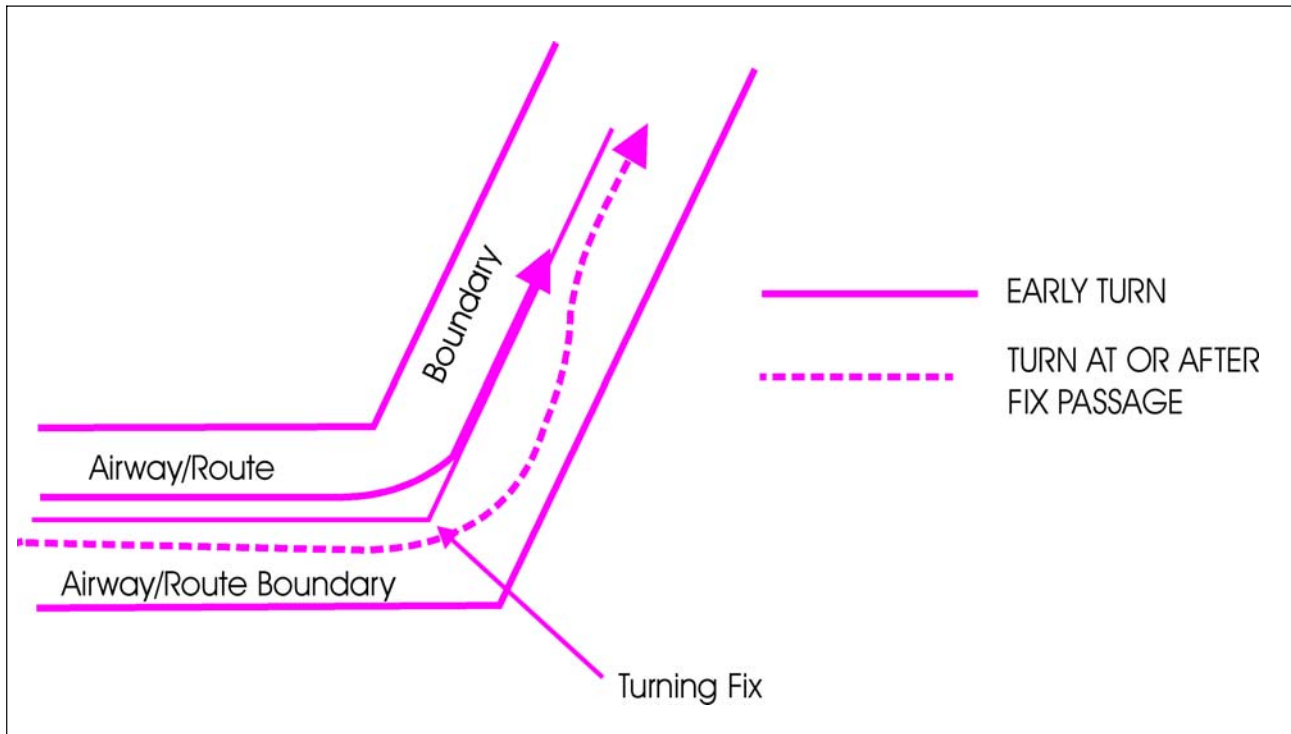

5-3-5. Airway or Route Course Changes

a. Pilots of aircraft are required to adhere to airways or routes being flown. Special attention must

be given to this requirement during course changes. Each course change consists of variables that make the technique applicable in each case a matter only the

pilot can resolve. Some variables which must be considered are turn radius, wind effect, airspeed, degree of turn, and cockpit instrumentation. An early turn, as illustrated below, is one method of adhering to airways or routes. The use of any available cockpit instrumentation, such as Distance Measuring Equipment, may be used by the pilot to lead the turn when making course changes. This *is consistent* with the intent of 14 CFR Section 91.181, which requires pilots to operate along the centerline of an airway and along the direct course between navigational aids or fixes.

b. Turns which begin at or after fix passage may exceed airway or route boundaries. FIG 5-3-1 contains an example flight track depicting this, together with an example of an early turn.

c. Without such actions as leading a turn, aircraft operating in excess of 290 knots true air speed (TAS) can exceed the normal airway or route boundaries depending on the amount of course change required, wind direction and velocity, the character of the turn fix (DME, overhead navigation aid, or intersection), and the pilot's technique in making a course change. For example, a flight operating at 17,000 feet MSL with a TAS of 400 knots, a 25 degree bank, and a course change of more than 40 degrees would exceed the width of the airway or route; i.e., 4 nautical miles each side of centerline. However, in the airspace below 18,000 feet MSL, operations in excess of 290 knots TAS are not prevalent and the provision of additional IFR separation in all course change situations for the occasional aircraft making a turn in excess of 290 knots TAS creates an unacceptable waste of airspace and imposes a penalty upon the preponderance of traffic which operate at low speeds. Consequently, the FAA expects pilots to lead turns and take other actions they consider necessary during course changes to adhere as closely as possible to the airways or route being flown.

5-3-6. Changeover Points (COPs)

a. COPs are prescribed for Federal airways, jet routes, area navigation routes, or other direct routes for which an MEA is designated under 14 CFR Part 95. The COP is a point along the route or airway segment between two adjacent navigation facilities or waypoints where changeover in navigation guidance should occur. At this point, the pilot should change

navigation receiver frequency from the station behind the aircraft to the station ahead.

b. The COP is normally located midway between the navigation facilities for straight route segments, or at the intersection of radials or courses forming a dogleg in the case of dogleg route segments. When the COP is NOT located at the midway point, aeronautical charts will depict the COP location and give the mileage to the radio aids.

c. COPs are established for the purpose of preventing loss of navigation guidance, to prevent frequency interference from other facilities, and to prevent use of different facilities by different aircraft in the same airspace. Pilots are urged to observe COPs to the fullest extent.

5-3-7. Minimum Turning Altitude (MTA)

Due to increased airspeeds at 10,000 ft MSL or above, the published minimum enroute altitude (MEA) may not be sufficient for obstacle clearance when a turn is required over a fix, NAVAID, or waypoint. In these instances, an expanded area in the vicinity of the turn point is examined to determine whether the published MEA is sufficient for obstacle clearance. In some locations (normally mountainous), terrain/obstacles in the expanded search area may necessitate a higher minimum altitude while conducting the turning maneuver. Turning fixes requiring a higher minimum turning altitude (MTA) will be denoted on government charts by the minimum crossing altitude (MCA) icon ("x" flag) and an accompanying note describing the MTA restriction. An MTA restriction will normally consist of the air traffic service (ATS) route leading to the turn point, the ATS route leading from the turn point, and the required altitude; e.g., MTA V330 E TO V520 W 16000. When an MTA is applicable for the intended route of flight, pilots must ensure they are at or above the charted MTA not later than the turn point and maintain at or above the MTA until joining the centerline of the ATS route following the turn point. Once established on the centerline following the turning fix, the MEA/MOCA determines the minimum altitude available for assignment. An MTA may also preclude the use of a specific altitude or a range of altitudes during a turn. For example, the MTA may restrict the use of 10,000 through 11,000 ft MSL. In this case, any altitude greater than 11,000 ft MSL is unrestricted, as are altitudes less than 10,000 ft MSL provided MEA/MOCA requirements are satisfied.

5-3-8. Holding

a. Whenever an aircraft is cleared to a fix other than the destination airport and delay is expected, it is the responsibility of ATC to issue complete holding instructions (unless the pattern is charted), an EFC time and best estimate of any additional en route/terminal delay.

NOTE-

Only those holding patterns depicted on U.S. government or commercially produced (meeting FAA requirements) low/high altitude en route, and area or STAR charts should be used.

b. If the holding pattern is charted and the controller doesn't issue complete holding instructions, the pilot is expected to hold as depicted on the appropriate chart. When the pattern is charted on the assigned procedure or route being flown, ATC may omit all holding instructions except the charted holding direction and the statement *AS PUBLISHED*; for example, *HOLD EAST AS PUBLISHED*. ATC must always issue complete holding instructions when pilots request them.

c. If no holding pattern is charted and holding instructions have not been issued, the pilot should ask ATC for holding instructions prior to reaching the fix. This procedure will eliminate the possibility of an aircraft entering a holding pattern other than that desired by ATC. If unable to obtain holding instructions prior to reaching the fix (due to frequency congestion, stuck microphone, etc.), then enter a standard pattern on the course on which the aircraft approached the fix and request further clearance as soon as possible. In this event, the altitude/flight level of the aircraft at the clearance limit will be protected so that separation will be provided as required.

d. When an aircraft is 3 minutes or less from a clearance limit and a clearance beyond the fix has not been received, the pilot is expected to start a speed reduction so that the aircraft will cross the fix, initially, at or below the maximum holding airspeed.

e. When no delay is expected, the controller should issue a clearance beyond the fix as soon as possible and, whenever possible, at least 5 minutes before the aircraft reaches the clearance limit.

f. Pilots should report to ATC the time and altitude/flight level at which the aircraft reaches the clearance limit and report leaving the clearance limit.

NOTE-

In the event of two-way communications failure, pilots are required to comply with 14 CFR Section 91.185.

g. When holding at a VOR station, pilots should begin the turn to the outbound leg at the time of the first complete reversal of the to/from indicator.

h. Patterns at the most generally used holding fixes are depicted (charted) on U.S. Government or commercially produced (meeting FAA requirements) Low or High Altitude En Route, Area, Departure Procedure, and STAR Charts. Pilots are expected to hold in the pattern depicted unless specifically advised otherwise by ATC.

NOTE-

Holding patterns that protect for a maximum holding airspeed other than the standard may be depicted by an icon, unless otherwise depicted. The icon is a standard holding pattern symbol (racetrack) with the airspeed restriction shown in the center. In other cases, the airspeed restriction will be depicted next to the standard holding pattern symbol.

REFERENCE-

AIM, Paragraph 5-3-8 j2, Holding

i. An ATC clearance requiring an aircraft to hold at a fix where the pattern is not charted will include the following information: (See FIG 5-3-2.)

1. Direction of holding from the fix in terms of the eight cardinal compass points (i.e., N, NE, E, SE, etc.).

2. Holding fix (the fix may be omitted if included at the beginning of the transmission as the clearance limit).

3. Radial, course, bearing, airway or route on which the aircraft is to hold.

4. Leg length in miles if DME or RNAV is to be used (leg length will be specified in minutes on pilot request or if the controller considers it necessary).

5. Direction of turn if left turns are to be made, the pilot requests, or the controller considers it necessary.

6. Time to expect further clearance and any pertinent additional delay information.

FIG 5-3-2
Holding Patterns

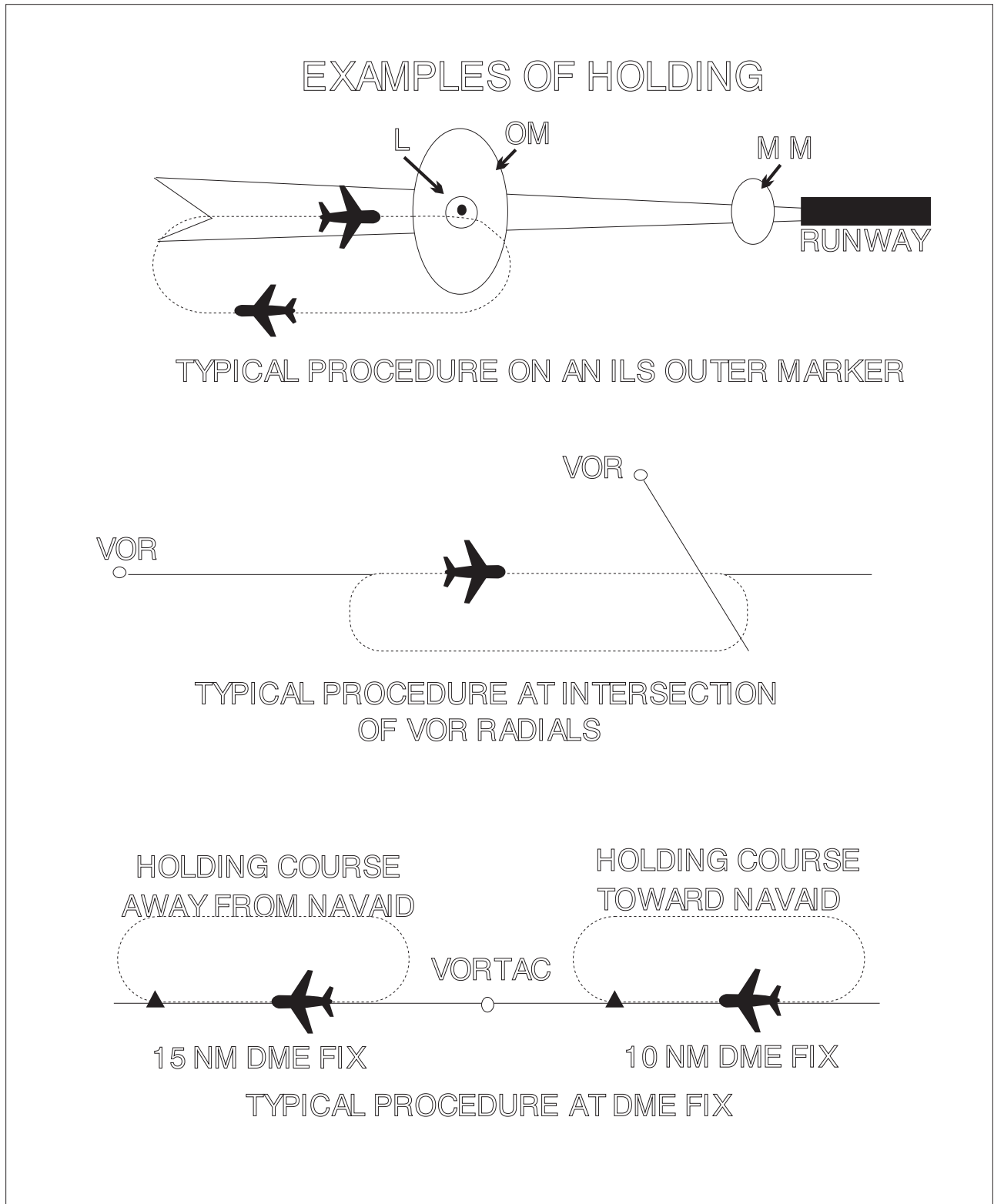
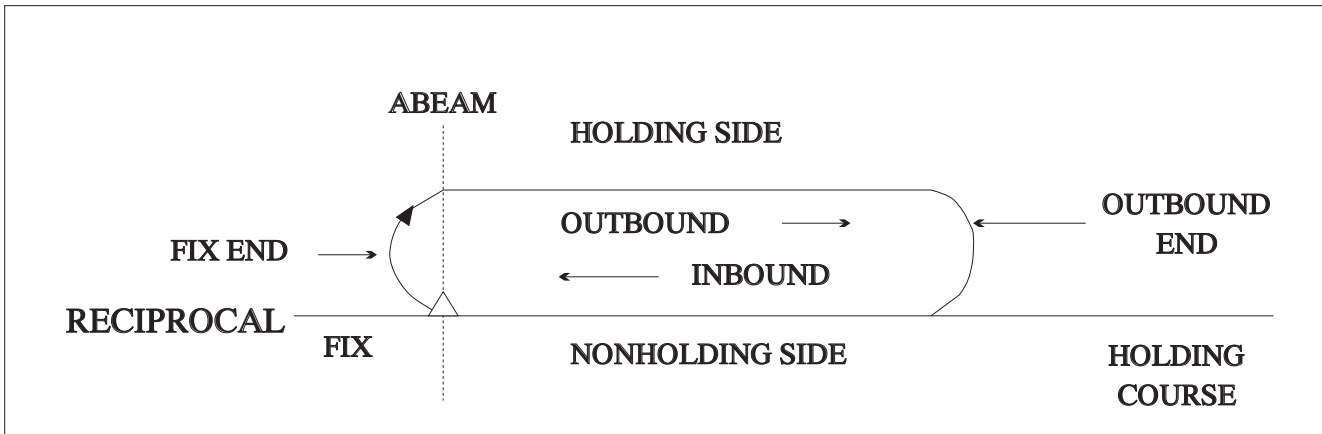

FIG 5-3-3
Holding Pattern Descriptive Terms



j. Holding pattern airspace protection is based on the following procedures.

1. Descriptive Terms.

(a) **Standard Pattern.** Right turns
(See FIG 5-3-3.)

(b) **Nonstandard Pattern.** Left turns

2. Airspeeds.

(a) All aircraft may hold at the following altitudes and maximum holding airspeeds:

TBL 5-3-20

Altitude (MSL)	Airspeed (KIAS)
MHA - 6,000'	200
6,001' - 14,000'	230
14,001' and above	265

NOTE-

These are the maximum indicated air speeds applicable to all holding.

(b) The following are exceptions to the maximum holding airspeeds:

(1) Holding patterns from 6,001' to 14,000' may be restricted to a maximum airspeed of 210 KIAS. This nonstandard pattern will be depicted by an icon.

(2) Holding patterns may be restricted to a maximum speed. The speed restriction is depicted in parenthesis inside the holding pattern on the chart: e.g., (175). The aircraft should be at or below the maximum speed prior to initially crossing the holding

fix to avoid exiting the protected airspace. Pilots unable to comply with the maximum airspeed restriction should notify ATC.

(3) Holding patterns at USAF airfields only - 310 KIAS maximum, unless otherwise depicted.

(4) Holding patterns at Navy fields only - 230 KIAS maximum, unless otherwise depicted.

(5) All helicopter/power lift aircraft holding on a "COPTER" instrument procedure is predicated on a minimum airspeed of 90 KIAS unless charted otherwise.

(6) When a climb-in hold is specified by a published procedure (for example, "Climb-in holding pattern to depart XYZ VORTAC at or above 10,000." or "All aircraft climb-in TRUCK holding pattern to cross TRUCK Int at or above 11,500 before proceeding on course."), additional obstacle protection area has been provided to allow for greater airspeeds in the climb for those aircraft requiring them. A maximum airspeed of 310 KIAS is permitted in Climb-in-holding, unless a maximum holding airspeed is published, in which case that maximum airspeed is applicable. The airspeed limitations in 14 CFR Section 91.117, Aircraft Speed, still apply.

(c) The following phraseology may be used by an ATCS to advise a pilot of the maximum holding airspeed for a holding pattern airspace area.

PHRASEOLOGY-

(AIRCRAFT IDENTIFICATION) (holding instructions, when needed) MAXIMUM HOLDING AIRSPEED IS (speed in knots).

FIG 5-3-4
Holding Pattern Entry Procedures

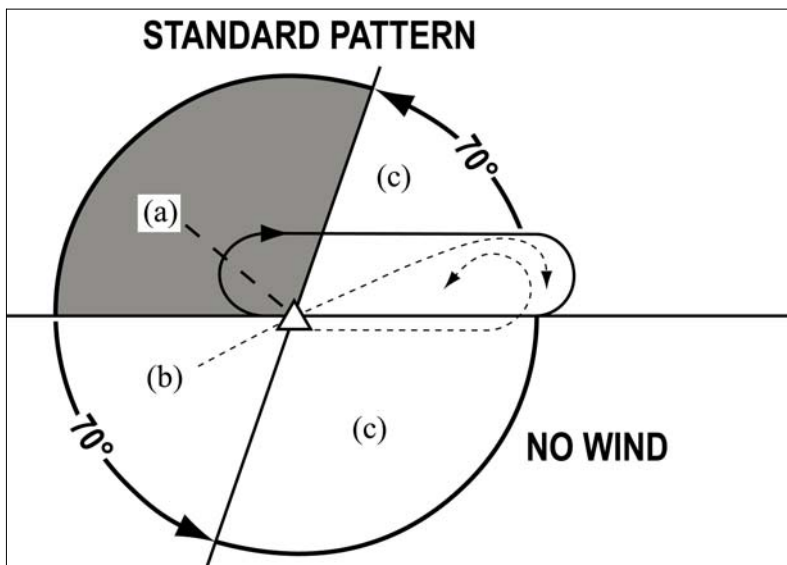

3. Entry Procedures. Holding protected airspace is designed based in part on pilot compliance with the three recommended holding pattern entry procedures discussed below. Deviations from these recommendations, coupled with excessive airspeed crossing the holding fix, may in some cases result in the aircraft exceeding holding protected airspace. (See FIG 5-3-4.)

(a) Parallel Procedure. When approaching the holding fix from anywhere in sector (a), the parallel entry procedure would be to turn to a heading to parallel the holding course outbound on the nonholding side for one minute, turn in the direction of the holding pattern through more than 180 degrees, and return to the holding fix or intercept the holding course inbound.

(b) Teardrop Procedure. When approaching the holding fix from anywhere in sector (b), the teardrop entry procedure would be to fly to the fix, turn outbound to a heading for a 30 degree teardrop entry within the pattern (on the holding side) for a period of one minute, then turn in the direction of the holding pattern to intercept the inbound holding course.

(c) Direct Entry Procedure. When approaching the holding fix from anywhere in sector (c), the direct entry procedure would be to fly

directly to the fix and turn to follow the holding pattern.

(d) While other entry procedures may enable the aircraft to enter the holding pattern and remain within protected airspace, the parallel, teardrop and direct entries are the procedures for entry and holding recommended by the FAA, and were derived as part of the development of the size and shape of the obstacle protection areas for holding.

(e) Nonstandard Holding Pattern. Fix end and outbound end turns are made to the left. Entry procedures to a nonstandard pattern are oriented in relation to the 70 degree line on the holding side just as in the standard pattern.

4. Timing.

(a) Inbound Leg.

- (1) At or below 14,000 feet MSL: 1 minute.
- (2) Above 14,000 feet MSL: 1¹/₂ minutes.

NOTE-

The initial outbound leg should be flown for 1 minute or 1 1/2 minutes (appropriate to altitude). Timing for subsequent outbound legs should be adjusted, as necessary, to achieve proper inbound leg time. Pilots may use any navigational means available; i.e., DME, RNAV, etc., to ensure the appropriate inbound leg times.

(b) Outbound leg timing begins over/abeam the fix, whichever occurs later. If the abeam position

cannot be determined, start timing when turn to outbound is completed.

5. Distance Measuring Equipment (DME)/GPS Along-Track Distance (ATD). DME/GPS holding is subject to the same entry and holding procedures except that distances (nautical miles) are used in lieu of time values. The outbound course of the DME/GPS holding pattern is called the outbound leg of the pattern. The controller or the instrument approach procedure chart will specify the length of the outbound leg. The end of the outbound leg is determined by the DME or ATD readout. The holding fix on conventional procedures, or controller defined

holding based on a conventional navigation aid with DME, is a specified course or radial and distances are from the DME station for both the inbound and outbound ends of the holding pattern. When flying published GPS overlay or stand alone procedures with distance specified, the holding fix will be a waypoint in the database and the end of the outbound leg will be determined by the ATD. Some GPS overlay and early stand alone procedures may have timing specified. (See FIG 5-3-5, FIG 5-3-6 and FIG 5-3-7.) See Paragraph 1-1-17, Global Positioning System (GPS), for requirements and restriction on using GPS for IFR operations.

**FIG 5-3-5
Inbound Toward NAVAID**

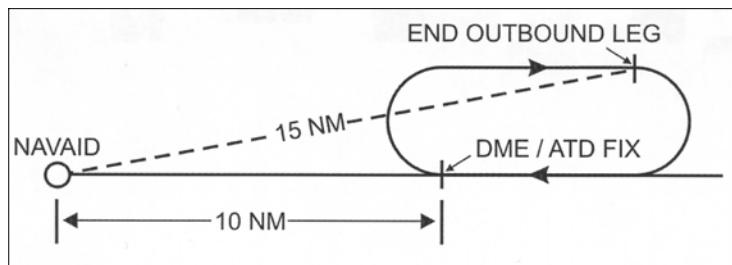

NOTE-

When the inbound course is toward the NAVAID, the fix distance is 10 NM, and the leg length is 5 NM, then the end of the outbound leg will be reached when the DME reads 15 NM.

**FIG 5-3-6
Inbound Leg Away from NAVAID**

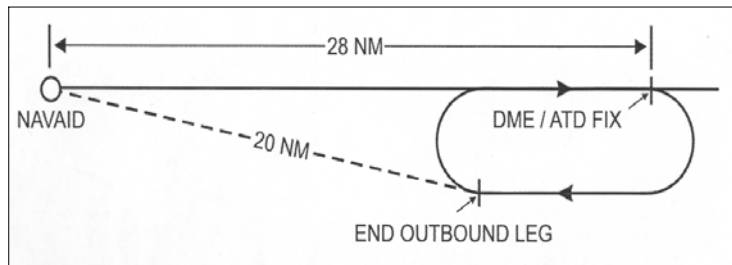

NOTE-

When the inbound course is away from the NAVAID and the fix distance is 28 NM, and the leg length is 8 NM, then the end of the outbound leg will be reached when the DME reads 20 NM.

6. Use of RNAV Distance in lieu of DME Distance. Substitution of RNAV computed distance to or from a NAVAID in place of DME distance is permitted when holding. However, the actual holding location and pattern flown will be further from the NAVAID than designed due to the lack of slant range in the position solution (see FIG 5-3-7). This may result in a slight difference between RNAV distance readout in reference to the NAVAID and the DME

readout, especially at higher altitudes. When used solely for DME substitution, the difference between RNAV distance to/from a fix and DME slant range distance can be considered negligible and no pilot action is required.

REFERENCE-

AIM Paragraph 1-2-3, Use of Suitable Area Navigation (RNAV) Systems on Conventional Procedures and Routes

FIG 5-3-7

Difference Between DME Distance From NAVAID & RNAV Computed Distance From NAVAID

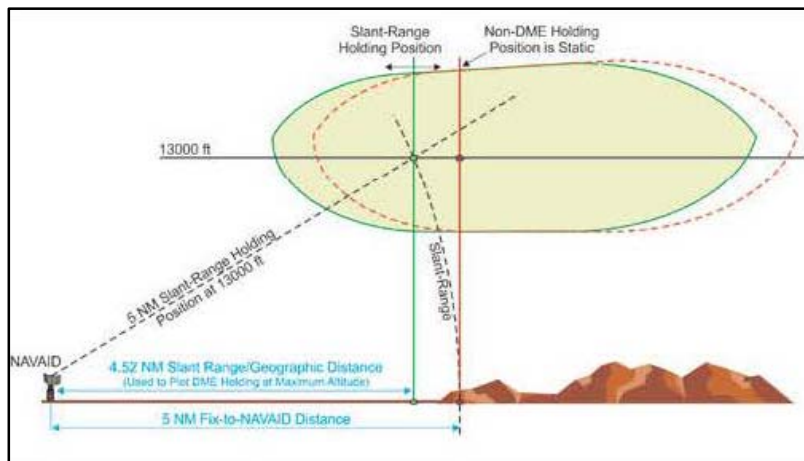

7. Use of RNAV Guidance and Holding. RNAV systems, including multi-sensor Flight Management Systems (FMS) and stand-alone GPS receivers, may be used to furnish lateral guidance when executing a hold. The manner in which holding is implemented in an RNAV system varies widely between aircraft and RNAV system manufacturers. Holding pattern data may be extracted from the RNAV database for published holds or may be manually entered for ad-hoc ATC-assigned holds. Pilots are expected to be familiar with the capabilities and limitations of the specific RNAV system used for holding.

(a) All holding, including holding defined on an RNAV or RNP procedure, is based on the conventional NAVAID holding design criteria, including the holding protected airspace construction. There are differences between the holding entry and flight track assumed in conventional holding pattern design and the entry and track that may be flown when RNAV guidance is used to execute holding. Individually, these differences may not affect the ability of the aircraft to remain within holding pattern protected airspace. However, cumu-

latively, they can result in deviations sufficient to result in excursions up to limits of the holding pattern protected airspace, and in some circumstances beyond protected airspace. The following difference and considerations apply when an RNAV system furnishes the lateral guidance used to fly a holding pattern:

(1) Many systems use ground track angle instead of heading to select the entry method. While the holding pattern design allows a 5 degree tolerance, this may result in an unexpected entry when the winds induce a large drift angle.

(2) The holding protected airspace is based on the assumption that the aircraft will fly-over the holding fix upon initial entry. RNAV systems may execute a “fly-by” turn when approaching the holding fix prior to entry. A “fly-by” turn during a direct entry from the holding side of holding course may result in excursions beyond protected airspace, especially as the intercept angle and ground speed increase.

(3) During holding, RNAV systems furnish lateral steering guidance using either a constant bank or constant radius to achieve the desired inbound and

outbound turns. An aircraft's flight guidance system may use reduced bank angles for all turns including turns in holding, especially at higher altitudes, that may result in exceeding holding protected airspace. Use of a shallower bank angle will expand both the width and length of the aircraft track, especially as wind speed increases. If the flight guidance system's bank angle limit feature is pilot-selectable, a minimum 25 degree bank angle should be selected regardless of altitude unless aircraft operating limitations specify otherwise and the pilot advises ATC.

(4) Where a holding distance is published, the turn from the outbound leg begins at the published distance from the holding fix, thus establishing the

design turn point required to remain within protected airspace. RNAV systems apply a database coded or pilot-entered leg distance as a maximum length of the inbound leg to the holding fix. The RNAV system then calculates a turn point from the outbound leg required to achieve this inbound leg length. This often results in an RNAV-calculated turn point on the outbound leg beyond the design turn point. (See FIG 5-3-8). With a strong headwind against the outbound leg, RNAV systems may fly up to and possibly beyond the limits of protected airspace before turning inbound. (See FIG 5-3-9.) This is especially true at higher altitudes where wind speeds are greater and ground speed results in a wider holding pattern.

FIG 5-3-8

RNAV Lateral Guidance and Holding – No Wind

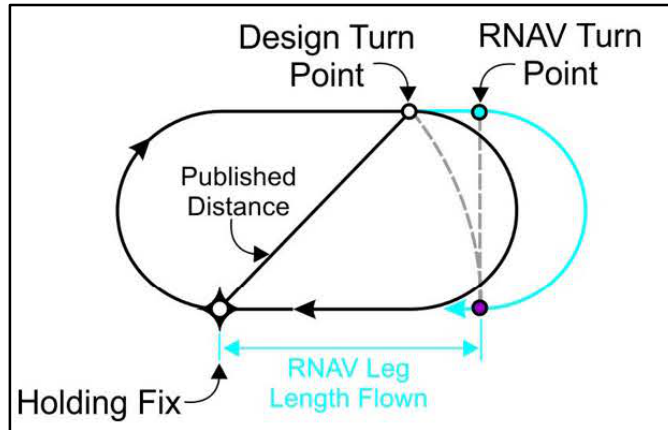
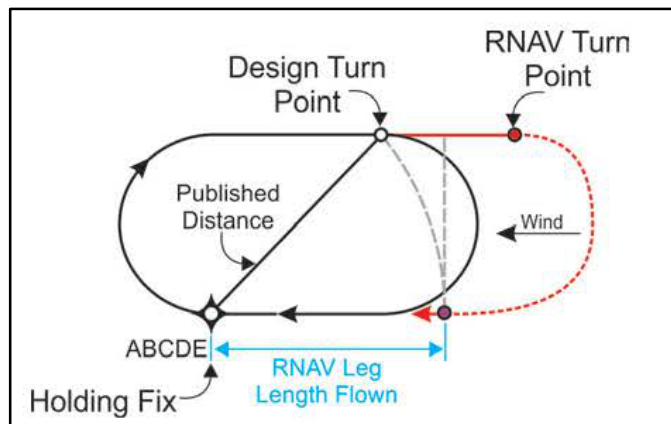

FIG 5-3-9

RNAV Lateral Guidance and Holding – Effect of Wind



(5) Some RNAV systems compute the holding pattern based on the aircraft's altitude and speed at a point prior to entering the hold. If the indicated airspeed is not reduced to comply with the maximum holding speed before this point, the computed pattern may exceed the protected airspace. Loading or executing a holding pattern may result in the speed and time limits applicable to the aircraft's current altitude being used to define the holding pattern for RNAV lateral guidance. This may result in an incorrect hold being flown by the RNAV system. For example, entering or executing the holding pattern above 14,000 feet when intending to hold below 14,000 feet may result in applying 1 ½ minute timing below 14,000 feet.

NOTE—

Some systems permit the pilot to modify leg time of holding patterns defined in the navigation database; for example, a hold-in-lieu of procedure turn. In most RNAV systems, the holding pattern time remains at the pilot-modified time and will not revert back to the coded time if the aircraft descends to a lower altitude where a shorter time interval applies.

(b) RNAV systems are not able to alert the pilot for excursions outside of holding pattern protected airspace since the dimensions of this airspace are not included in the navigation database. In addition, the dimensions of holding pattern protected airspace vary with altitude for a charted holding pattern, even when the hold is used for the same application. Close adherence to the pilot actions described in this section reduce the likelihood of exceeding the boundary of holding pattern protected airspace when using RNAV lateral guidance to conduct holding.

(c) Holding patterns may be stored in the RNAV system's navigation database and include coding with parameters defining how the RNAV system will conduct the hold. For example, coding will determine whether holding is conducted to manual termination (HM), continued holding until the aircraft reaches a specified altitude (HA), or holding is conducted until the holding fix is crossed the first time after entry (HF). Some systems do not store all holding patterns, and may only store patterns associated with missed approaches and hold-in-lieu of procedure turn (HILPT). Some store all holding as standard patterns and require pilot action to conduct non-standard holding (left turns).

(1) Pilots are cautioned that multiple holding patterns may be established at the same fix. These holding patterns may differ in respect to turn directions and leg lengths depending on their application as an en route holding pattern, a holding pattern charted on a SID or STAR, or when used on an instrument approach procedure. Many RNAV systems limit the database coding at a particular fix to a single holding pattern definition. Pilots extracting the holding pattern from the navigation database are responsible for confirming that the holding pattern conforms to the assigned charted holding pattern in terms of turn direction, speed limit, timing, and distance.

(2) If ATC assigns holding that is not charted, then the pilot is responsible for programming the RNAV system with the assigned holding course, turn direction, speed limit, leg length, or leg time.

(3) Changes made after the initial execution may not apply until the next circuit of the holding pattern if the aircraft is in close proximity to the holding fix.

8. Pilot Action. The following actions are recommended to ensure that the aircraft remains within holding protected airspace when holding is performed using either conventional NAVAID guidance or when using RNAV lateral guidance.

(a) **Speed.** When ATC furnishes advance notice of holding, start speed reduction to be at or below the maximum holding speed allowed at least 3 minutes prior to crossing the holding fix. If advance notice by ATC is not provided, begin speed reduction as expeditiously as practical. It is acceptable to allow RNAV systems to determine an appropriate deceleration point prior to the holding fix and to manage the speed reduction to the RNAV computed holding speed. If the pilot does not permit the RNAV system to manage the deceleration from the computed point, the actual hold pattern size at holding entry may differ from the holding pattern size computed by the RNAV system.

(1) Aircraft are expected to enter holding at or below the maximum holding speed established in paragraph 5-3-8 j 2(a) or the charted maximum holding speed.

[a] All fixed wing aircraft conducting holding should fly at speeds at or above 90 KIAS to minimize the influence of wind drift.

[b] When RNAV lateral guidance is used in fixed wing airplanes, it is desirable to enter and conduct holding at the lowest practical airspeed consistent with the airplane's recommended holding speed to address the cumulative errors associated with RNAV holding and increase the probability of remaining within protected airspace. It is acceptable to allow RNAV systems to determine a recommended holding speed *that is at or below the maximum holding speed*.

[c] Helicopter holding is based on a minimum airspeed of 90 KIAS.

(2) Advise ATC immediately if unable to comply with the maximum holding airspeed and request an alternate clearance.

NOTE—

Speeds above the maximum or published holding speed may be necessary due to turbulence, icing, etc. Exceeding maximum holding airspeed may result in aircraft excursions beyond the holding pattern protected airspace. In a non-radar environment, the pilot should advise ATC that they cannot accept the assigned hold.

(3) Ensure the RNAV system applies the proper time and speed restrictions to a holding pattern. This is especially critical when climbing or descending to a holding pattern altitude where time and speed restrictions are different than at the present aircraft altitude.

(b) Bank Angle. For holding not involving the use of RNAV lateral guidance, make all turns during entry and while holding at:

(1) 3 degrees per second, or

(2) 30 degree bank angle, or

(3) 25 degree bank angle, provided a flight director system is used.

NOTE—

Use whichever requires the least bank angle.

(4) When using RNAV lateral guidance to conduct holding, it is acceptable to permit the RNAV system to calculate the appropriate bank angle for the outbound and inbound turns. Do not use flight guidance system bank angle limiting functions of less than 25 degrees unless the feature is not pilot-selectable, required by the aircraft limitations, or its use is necessary to comply with the aircraft's minimum

maneuvering speed margins. If the bank angle must be limited to less than 25 degrees, advise ATC that additional area for holding is required.

(c) Compensate for wind effect primarily by drift correction on the inbound and outbound legs. When outbound, triple the inbound drift correction to avoid major turning adjustments; for example, if correcting left by 8 degrees when inbound, correct right by 24 degrees when outbound.

(d) Determine entry turn from aircraft heading upon arrival at the holding fix; +/- 5 degrees in heading is considered to be within allowable good operating limits for determining entry. When using RNAV lateral guidance for holding, it is permissible to allow the system to compute the holding entry.

(e) RNAV lateral guidance may execute a fly-by turn beginning at an excessively large distance from the holding fix. Reducing speed to the maximum holding speed at least 3 minutes prior to reaching the holding fix and using the recommended 25 degree bank angle will reduce potential excursions beyond protected airspace.

(f) When RNAV guidance is used for holding, pilots should be prepared to intervene if the turn from outbound leg to the inbound leg does not begin within a reasonable distance of the charted leg length, especially when holding is used as a course reversal HILPT. Pilot intervention is not required when holding in an ATC-assigned holding pattern that is not charted. However, notify ATC when the outbound leg length becomes excessive when RNAV guidance is used for holding.

k. When holding at a fix and instructions are received specifying the time of departure from the fix, the pilot should adjust the aircraft's flight path within the limits of the established holding pattern in order to leave the fix at the exact time specified. After departing the holding fix, normal speed is to be resumed with respect to other governing speed requirements, such as terminal area speed limits, specific ATC requests, etc. Where the fix is associated with an instrument approach and timed approaches are in effect, a procedure turn must not be executed unless the pilot advises ATC, since aircraft holding are expected to proceed inbound on final approach directly from the holding pattern when approach clearance is received.

1. Radar surveillance of holding pattern airspace areas.

1. Whenever aircraft are holding, ATC will usually provide radar surveillance of the holding airspace on the controller's radar display.

2. The controller will attempt to detect any holding aircraft that stray outside the holding airspace and will assist any detected aircraft to return to the assigned airspace.

NOTE—

Many factors could prevent ATC from providing this additional service, such as workload, number of targets, precipitation, ground clutter, and radar system capability. These circumstances may make it unfeasible to maintain radar identification of aircraft to detect aircraft straying from the holding pattern. The provision of this service depends entirely upon whether controllers believe they are in a position to provide it and does not relieve a pilot of their responsibility to adhere to an accepted ATC clearance.

3. ATC is responsible for traffic and obstruction separation when they have assigned holding that is

not associated with a published (charted) holding pattern. Altitudes assigned will be at or above the minimum vectoring or minimum IFR altitude.

4. If an aircraft is established in a published holding pattern at an assigned altitude above the published minimum holding altitude and subsequently cleared for the approach, the pilot may descend to the published minimum holding altitude. The holding pattern would only be a segment of the IAP *if* it is published on the instrument procedure chart and is used in lieu of a procedure turn.

m. For those holding patterns where there are no published minimum holding altitudes, the pilot, upon receiving an approach clearance, must maintain the last assigned altitude until leaving the holding pattern and established on the inbound course. Thereafter, the published minimum altitude of the route segment being flown will apply. It is expected that the pilot will be assigned a holding altitude that will permit a normal descent on the inbound course.

Section 4. Arrival Procedures

5-4-1. Standard Terminal Arrival (STAR) Procedures

a. A STAR is an ATC coded IFR arrival route established for application to arriving IFR aircraft destined for certain airports. STARs simplify clearance delivery procedures, and also facilitate transition between en route and instrument approach procedures.

1. STAR procedures may have mandatory speeds and/or crossing altitudes published. Other STARs may have planning information depicted to inform pilots what clearances or restrictions to “**expect**.” “**Expect**” altitudes/speeds are not considered STAR procedures crossing restrictions unless verbally issued by ATC. Published speed restrictions are independent of altitude restrictions and are mandatory unless modified by ATC. Pilots should plan to cross waypoints with a published speed restriction, at the published speed, and should not exceed this speed past the associated waypoint unless authorized by ATC or a published note to do so.

NOTE-

The “**expect**” altitudes/speeds are published so that pilots may have the information for planning purposes. These altitudes/speeds must not be used in the event of lost communications unless ATC has specifically advised the pilot to expect these altitudes/speeds as part of a further clearance.

REFERENCE-

14 CFR Section 91.185(c)(2)(iii).

2. Pilots navigating on, or navigating a published route inbound to, a STAR procedure must maintain last assigned altitude until receiving authorization to descend so as to comply with all published/issued restrictions. This authorization may contain the phraseology “DESCEND VIA.” If vectored or cleared to deviate off of a STAR, pilots must consider the STAR canceled, unless the controller adds “expect to resume STAR;” pilots should then be prepared to rejoin the STAR at a subsequent fix or procedure leg. If a descent clearance has been received that included a crossing restriction, pilots should expect the controller to issue an altitude to maintain.

(a) Clearance to “descend via” authorizes pilots to:

(1) Descend at pilot’s discretion to meet published restrictions and laterally navigate on a STAR.

(2) When cleared to a waypoint depicted on a STAR, to descend from a previously assigned altitude at pilot’s discretion to the altitude depicted at that waypoint.

(3) Once established on the depicted arrival, to descend and to meet all published or assigned altitude and/or speed restrictions.

NOTE-

1. When otherwise cleared along a route or procedure that contains published speed restrictions, the pilot must comply with those speed restrictions independent of any descend via clearance.

2. ATC anticipates pilots will begin adjusting speed the minimum distance necessary prior to a published speed restriction so as to cross the waypoint/fix at the published speed. Once at the published speed, ATC expects pilots will maintain the published speed until additional adjustment is required to comply with further published or ATC assigned speed restrictions or as required to ensure compliance with 14 CFR Section 91.117.

3. The “descend via” is used in conjunction with STARs to reduce phraseology by not requiring the controller to restate the altitude at the next waypoint/fix to which the pilot has been cleared.

4. Air traffic will assign an altitude to cross the waypoint/fix, if no altitude is depicted at the waypoint/fix, for aircraft on a direct routing to a STAR. Air traffic must ensure obstacle clearance when issuing a “descend via” instruction to the pilot.

5. Minimum en route altitudes (MEA) are not considered restrictions; however, pilots must remain above all MEAs, unless receiving an ATC instruction to descend below the MEA.

EXAMPLE-

1. **Lateral/routing clearance only.**

“Cleared Tyler One arrival.”

NOTE-

In Example 1, pilots are cleared to fly the lateral path of the procedure. Compliance with any published speed restrictions is required. No descent is authorized.

2. **Routing with assigned altitude.**

“Cleared Tyler One arrival, descend and maintain flight level two four zero.”

“Cleared Tyler One arrival, descend at pilot’s discretion, maintain flight level two four zero.”

NOTE–

In Example 2, the first clearance requires the pilot to descend to FL 240 as directed, comply with any published speed restrictions, and maintain FL 240 until cleared for further vertical navigation with a newly assigned altitude or a “descend via” clearance.

The second clearance authorizes the pilot to descend to FL 240 at his discretion, to comply with any published speed restrictions, and then maintain FL 240 until issued further instructions.

3. Lateral/routing and vertical navigation clearance.

“Descend via the Eagul Five arrival.”

“Descend via the Eagul Five arrival, except, cross Vnnom at or above one two thousand.”

NOTE–

In Example 3, the first clearance authorized the aircraft to descend at pilot’s discretion on the Eagul Five arrival; the pilot must descend so as to comply with all published altitude and speed restrictions.

The second clearance authorizes the same, but requires the pilot to descend so as to cross at Vnnom at or above 12,000.

4. Lateral/routing and vertical navigation clearance when assigning altitude not published on procedure.

“Descend via the Eagul Five arrival, except after Geeno, maintain one zero thousand.”

“Descend via the Eagul Five arrival, except cross Geeno at one one thousand then maintain seven thousand.”

NOTE–

In Example 4, the first clearance authorized the aircraft to track laterally on the Eagul Five Arrival and to descend at pilot’s discretion so as to comply with all altitude and speed restrictions until reaching Geeno and then maintain 10,000. Upon reaching 10,000, aircraft should maintain 10,000 until cleared by ATC to continue to descend.

The second clearance requires the same, except the aircraft must cross Geeno at 11,000 and is then authorized to continue descent to and maintain 7,000.

5. Direct routing to intercept a STAR and vertical navigation clearance.

“Proceed direct Leoni, descend via the Leoni One arrival.”

“Proceed direct Denis, cross Denis at or above flight level two zero zero, then descend via the Mmell One arrival.”

NOTE–

In Example 5, in the first clearance an altitude is published at Leoni; the aircraft proceeds to Leoni, crosses Leoni at the published altitude and then descends via the arrival. If a speed restrictions is published at Leoni, the aircraft will

slow to comply with the published speed.

In the second clearance, there is no altitude published at Denis; the aircraft must cross Denis at or above FL200, and then descends via the arrival.

(b) Pilots cleared for vertical navigation using the phraseology “descend via” must inform ATC upon initial contact with a new frequency, of the altitude leaving, “descending via (procedure name),” the runway transition or landing direction if assigned, and any assigned restrictions not published on the procedure.

EXAMPLE–

1. Delta 121 is cleared to descend via the Eagul Five arrival, runway 26 transition: “Delta One Twenty One leaving flight level one niner zero, descending via the Eagul Five arrival runway two-six transition.”

2. Delta 121 is cleared to descend via the Eagul Five arrival, but ATC has changed the bottom altitude to 12,000: “Delta One Twenty One leaving flight level one niner zero for one two thousand, descending via the Eagul Five arrival, runway two-six transition.”

3. (JetBlue 602 is cleared to descend via the Ivane Two arrival, landing south): “JetBlue six zero two leaving flight level two one zero descending via the Ivane Two arrival landing south.”

b. Pilots of IFR aircraft destined to locations for which STARS have been published may be issued a clearance containing a STAR whenever ATC deems it appropriate.

c. Use of STARS requires pilot possession of at least the approved chart. RNAV STARS must be retrievable by the procedure name from the aircraft database and conform to charted procedure. As with any ATC clearance or portion thereof, it is the responsibility of each pilot to accept or refuse an issued STAR. Pilots should notify ATC if they do not wish to use a STAR by placing “NO STAR” in the remarks section of the flight plan or by the less desirable method of verbally stating the same to ATC.

d. STAR charts are published in the Terminal Procedures Publications (TPP) and are available on subscription from the National Aeronautical Charting Office.

e. PBN STAR.

1. Public PBN STARS are normally designed using RNAV 1, RNP 1, or A–RNP NavSpecs. These procedures require system performance currently met by GPS or DME/DME/IRU PBN systems that

satisfy the criteria discussed in AC 90–100A, U.S. Terminal and En Route Area Navigation (RNAV) Operations. These procedures, using RNAV 1 and RNP 1 NavSpecs, must maintain a total system error of not more than 1 NM for 95% of the total flight time. Minimum values for A–RNP procedures will be charted in the PBN box (for example, 1.00 or 0.30).

2. In the U.S., a specific procedure’s PBN requirements will be prominently displayed in separate, standardized notes boxes. For procedures with PBN elements, the “PBN box” will contain the procedure’s NavSpec(s); and, if required: specific sensors or infrastructure needed for the navigation solution, any additional or advanced functional requirements, the minimum RNP value, and any amplifying remarks. Items listed in this PBN box are REQUIRED for the procedure’s PBN elements.

5–4–2. Local Flow Traffic Management Program

a. This program is a continuing effort by the FAA to enhance safety, minimize the impact of aircraft noise and conserve aviation fuel. The enhancement of safety and reduction of noise is achieved in this program by minimizing low altitude maneuvering of arriving turbojet and turboprop aircraft weighing more than 12,500 pounds and, by permitting departure aircraft to climb to higher altitudes sooner, as arrivals are operating at higher altitudes at the points where their flight paths cross. The application of these procedures also reduces exposure time between controlled aircraft and uncontrolled aircraft at the lower altitudes in and around the terminal environment. Fuel conservation is accomplished by absorbing any necessary arrival delays for aircraft included in this program operating at the higher and more fuel efficient altitudes.

b. A fuel efficient descent is basically an uninterrupted descent (except where level flight is required for speed adjustment) from cruising altitude to the point when level flight is necessary for the pilot to stabilize the aircraft on final approach. The procedure for a fuel efficient descent is based on an altitude loss which is most efficient for the majority of aircraft being served. This will generally result in a descent gradient window of 250–350 feet per nautical mile.

c. When crossing altitudes and speed restrictions are issued verbally or are depicted on a chart, ATC will expect the pilot to descend first to the crossing altitude and then reduce speed. Verbal clearances for descent will normally permit an uninterrupted descent in accordance with the procedure as described in paragraph b above. Acceptance of a charted fuel efficient descent (Runway Profile Descent) clearance requires the pilot to adhere to the altitudes, speeds, and headings depicted on the charts unless otherwise instructed by ATC. PILOTS RECEIVING A CLEARANCE FOR A FUEL EFFICIENT DESCENT ARE EXPECTED TO ADVISE ATC IF THEY DO NOT HAVE RUNWAY PROFILE DESCENT CHARTS PUBLISHED FOR THAT AIRPORT OR ARE UNABLE TO COMPLY WITH THE CLEARANCE.

5–4–3. Approach Control

a. Approach control is responsible for controlling all instrument flight operating within its area of responsibility. Approach control may serve one or more airfields, and control is exercised primarily by direct pilot and controller communications. Prior to arriving at the destination radio facility, instructions will be received from ARTCC to contact approach control on a specified frequency.

b. Radar Approach Control.

1. Where radar is approved for approach control service, it is used not only for radar approaches (Airport Surveillance Radar [ASR] and Precision Approach Radar [PAR]) but is also used to provide vectors in conjunction with published nonradar approaches based on radio NAVAIDs (ILS, VOR, NDB, TACAN). Radar vectors can provide course guidance and expedite traffic to the final approach course of any established IAP or to the traffic pattern for a visual approach. Approach control facilities that provide this radar service will operate in the following manner:

(a) Arriving aircraft are either cleared to an outer fix most appropriate to the route being flown with vertical separation and, if required, given holding information or, when radar handoffs are effected between the ARTCC and approach control, or between two approach control facilities, aircraft are cleared to the airport or to a fix so located that the handoff will be completed prior to the time the aircraft reaches the fix. When radar handoffs are

utilized, successive arriving flights may be handed off to approach control with radar separation in lieu of vertical separation.

(b) After release to approach control, aircraft are vectored to the final approach course (ILS, RNAV, GLS, VOR, ADF, etc.). Radar vectors and altitude or flight levels will be issued as required for spacing and separating aircraft. *Therefore, pilots must not deviate from the headings issued by approach control.* Aircraft will normally be informed when it is necessary to vector across the final approach course for spacing or other reasons. If approach course crossing is imminent and the pilot has not been informed that the aircraft will be vectored across the final approach course, the pilot should query the controller.

(c) The pilot is not expected to turn inbound on the final approach course unless an approach clearance has been issued. This clearance will normally be issued with the final vector for interception of the final approach course, and the vector will be such as to enable the pilot to establish the aircraft on the final approach course prior to reaching the final approach fix.

(d) In the case of aircraft already inbound on the final approach course, approach clearance will be issued prior to the aircraft reaching the final approach fix. When established inbound on the final approach course, radar separation will be maintained and the pilot will be expected to complete the approach utilizing the approach aid designated in the clearance (ILS, RNAV, GLS, VOR, radio beacons, etc.) as the primary means of navigation. Therefore, once established on the final approach course, pilots must not deviate from it unless a clearance to do so is received from ATC.

(e) After passing the final approach fix on final approach, aircraft are expected to continue inbound on the final approach course and complete the approach or effect the missed approach procedure published for that airport.

2. ARTCCs are approved for and may provide approach control services to specific airports. The radar systems used by these centers do not provide the same precision as an ASR/PAR used by approach control facilities and towers, and the update rate is not as fast. Therefore, pilots may be requested to report established on the final approach course.

3. Whether aircraft are vectored to the appropriate final approach course or provide their own navigation on published routes to it, radar service is automatically terminated when the landing is completed or when instructed to change to advisory frequency at uncontrolled airports, whichever occurs first.

5-4-4. Advance Information on Instrument Approach

a. When landing at airports with approach control services and where two or more IAPs are published, pilots will be provided in advance of their arrival with the type of approach to expect or that they may be vectored for a visual approach. This information will be broadcast either by a controller or on ATIS. It will not be furnished when the visibility is three miles or better and the ceiling is at or above the highest initial approach altitude established for any low altitude IAP for the airport.

b. The purpose of this information is to aid the pilot in planning arrival actions; however, it is not an ATC clearance or commitment and is subject to change. Pilots should bear in mind that fluctuating weather, shifting winds, blocked runway, etc., are conditions which may result in changes to approach information previously received. It is important that pilots advise ATC immediately they are unable to execute the approach ATC advised will be used, or if they prefer another type of approach.

c. Aircraft destined to uncontrolled airports, which have automated weather data with broadcast capability, should monitor the ASOS/AWOS frequency to ascertain the current weather for the airport. The pilot must advise ATC when he/she has received the broadcast weather and state his/her intentions.

NOTE-

1. ASOS/AWOS should be set to provide one-minute broadcast weather updates at uncontrolled airports that are without weather broadcast capability by a human observer.

2. Controllers will consider the long line disseminated weather from an automated weather system at an uncontrolled airport as trend and planning information only and will rely on the pilot for current weather information for the airport. If the pilot is unable to receive the current broadcast weather, the last long line disseminated weather will be issued to the pilot. When receiving IFR services, the pilot/aircraft operator is

responsible for determining if weather/visibility is adequate for approach/landing.

d. When making an IFR approach to an airport not served by a tower or FSS, after ATC advises “CHANGE TO ADVISORY FREQUENCY APPROVED” you should broadcast your intentions, including the type of approach being executed, your position, and when over the final approach fix inbound (nonprecision approach) or when over the outer marker or fix used in lieu of the outer marker inbound (precision approach). Continue to monitor the appropriate frequency (UNICOM, etc.) for reports from other pilots.

5-4-5. Instrument Approach Procedure (IAP) Charts

a. 14 CFR Section 91.175(a), Instrument approaches to civil airports, requires the use of SIAPs prescribed for the airport in 14 CFR Part 97 unless otherwise authorized by the Administrator (including ATC). If there are military procedures published at a civil airport, aircraft operating under 14 CFR Part 91 must use the civil procedure(s). Civil procedures are defined with “FAA” in parenthesis; e.g., (FAA), at the top, center of the procedure chart. DOD procedures are defined using the abbreviation of the applicable military service in parenthesis; e.g., (USAF), (USN), (USA). 14 CFR Section 91.175(g), Military airports, requires civil pilots flying into or out of military airports to comply with the IAPs and takeoff and landing minimums prescribed by the authority having jurisdiction at those airports. Unless an emergency exists, civil aircraft operating at military airports normally require advance authorization, commonly referred to as “Prior Permission Required” or “PPR.” Information on obtaining a PPR for a particular military airport can be found in the Chart Supplement U.S.

NOTE-

Civil aircraft may conduct practice VFR approaches using DOD instrument approach procedures when approved by the air traffic controller.

1. IAPs (standard and special, civil and military) are based on joint civil and military criteria contained in the U.S. Standard for TERPS. The design of IAPs based on criteria contained in TERPS, takes into account the interrelationship between airports, facilities, and the surrounding environment, terrain,

obstacles, noise sensitivity, etc. Appropriate altitudes, courses, headings, distances, and other limitations are specified and, once approved, the procedures are published and distributed by government and commercial cartographers as instrument approach charts.

2. Not all IAPs are published in chart form. Radar IAPs are established where requirements and facilities exist but they are printed in tabular form in appropriate U.S. Government Flight Information Publications.

3. The navigation equipment required to join and fly an instrument approach procedure is indicated by the title of the procedure and notes on the chart.

(a) Straight-in IAPs are identified by the navigational system providing the final approach guidance and the runway to which the approach is aligned (e.g., VOR RWY 13). Circling only approaches are identified by the navigational system providing final approach guidance and a letter (e.g., VOR A). More than one navigational system separated by a slash indicates that more than one type of equipment must be used to execute the final approach (e.g., VOR/DME RWY 31). More than one navigational system separated by the word “or” indicates either type of equipment may be used to execute the final approach (e.g., VOR or GPS RWY 15).

(b) In some cases, other types of navigation systems including radar may be required to execute other portions of the approach or to navigate to the IAF (e.g., an NDB procedure turn to an ILS, an NDB in the missed approach, or radar required to join the procedure or identify a fix). When radar or other equipment is required for procedure entry from the en route environment, a note will be charted in the planview of the approach procedure chart (e.g., RADAR REQUIRED or ADF REQUIRED). When radar or other equipment is required on portions of the procedure outside the final approach segment, including the missed approach, a note will be charted in the notes box of the pilot briefing portion of the approach chart (e.g., RADAR REQUIRED or DME REQUIRED). Notes are not charted when VOR is required outside the final approach segment. Pilots should ensure that the

aircraft is equipped with the required NAVAID(s) in order to execute the approach, including the missed approach.

NOTE—

Some military (i.e., U.S. Air Force and U.S. Navy) IAPs have these “additional equipment required” notes charted only in the planview of the approach procedure and do not conform to the same application standards used by the FAA.

(c) The FAA has initiated a program to provide a new notation for LOC approaches when charted on an ILS approach requiring other navigational aids to fly the final approach course. The LOC minimums will be annotated with the NAVAID required (e.g., “DME Required” or “RADAR Required”). During the transition period, ILS approaches will still exist without the annotation.

(d) Many ILS approaches having minima based on RVR are eligible for a landing minimum of RVR 1800. Some of these approaches are to runways that have touchdown zone and centerline lights. For many runways that do not have touchdown and centerline lights, it is still possible to allow a landing minimum of RVR 1800. For these runways, the normal ILS minimum of RVR 2400 can be annotated with a single or double asterisk or the dagger symbol “†”; for example “** 696/24 200 (200/1/2).” A note is included on the chart stating “**RVR 1800 authorized with use of FD or AP or HUD to DA.” The pilot must use the flight director, or autopilot with an approved approach coupler, or head up display to decision altitude or to the initiation of a missed approach. In the interest of safety, single pilot operators should not fly approaches to 1800 RVR minimums on runways without touchdown and centerline lights using only a flight director, unless accompanied by the use of an autopilot with an approach coupler.

(e) The naming of multiple approaches of the same type to the same runway is also changing. Multiple approaches with the same guidance will be annotated with an alphabetical suffix beginning at the end of the alphabet and working backwards for subsequent procedures (e.g., ILS Z RWY 28, ILS Y RWY 28, etc.). The existing annotations such as ILS 2 RWY 28 or Silver ILS RWY 28 will be phased out and replaced with the new designation. The Cat II and Cat III designations are used to differentiate

between multiple ILSs to the same runway unless there are multiples of the same type.

(f) RNAV (GPS) approaches to LNAV, LP, LNAV/VNAV and LPV lines of minima using WAAS and RNAV (GPS) approaches to LNAV and LNAV/VNAV lines of minima using GPS are charted as RNAV (GPS) RWY (Number) (e.g., RNAV (GPS) RWY 21). VOR/DME RNAV approaches will continue to be identified as VOR/DME RNAV RWY (Number) (e.g., VOR/DME RNAV RWY 21). VOR/DME RNAV procedures which can be flown by GPS will be annotated with “or GPS” (e.g., VOR/DME RNAV or GPS RWY 31).

(g) Performance-Based Navigation (PBN) Box. As charts are updated, a procedure’s PBN requirements and conventional equipment requirements will be prominently displayed in separate, standardized notes boxes. For procedures with PBN elements, the PBN box will contain the procedure’s navigation specification(s); and, if required: specific sensors or infrastructure needed for the navigation solution, any additional or advanced functional requirements, the minimum Required Navigation Performance (RNP) value, and any amplifying remarks. Items listed in this PBN box are REQUIRED for the procedure’s PBN elements. For example, an ILS with an RNAV missed approach would require a specific capability to fly the missed approach portion of the procedure. That required capability will be listed in the PBN box. The separate Equipment Requirements box will list ground-based equipment requirements. On procedures with both PBN elements and equipment requirements, the PBN requirements box will be listed first. The publication of these notes will continue incrementally until all charts have been amended to comply with the new standard.

4. Approach minimums are based on the local altimeter setting for that airport, unless annotated otherwise; e.g., Oklahoma City/Will Rogers World approaches are based on having a Will Rogers World altimeter setting. When a different altimeter source is required, or more than one source is authorized, it will be annotated on the approach chart; e.g., use Sidney altimeter setting, if not received, use Scottsbluff altimeter setting. Approach minimums may be raised when a nonlocal altimeter source is authorized. When more than one altimeter source is authorized, and the minima are different, they will be shown by separate lines in the approach minima box or a note; e.g., use

Manhattan altimeter setting; when not available use Salina altimeter setting and increase all MDAs 40 feet. When the altimeter must be obtained from a source other than air traffic a note will indicate the source; e.g., Obtain local altimeter setting on CTAF. When the altimeter setting(s) on which the approach is based is not available, the approach is not authorized. Baro-VNAV must be flown using the local altimeter setting only. Where no local altimeter is available, the LNAV/VNAV line will still be published for use by WAAS receivers with a note that Baro-VNAV is not authorized. When a local and at least one other altimeter setting source is authorized and the local altimeter is not available Baro-VNAV is not authorized; however, the LNAV/VNAV minima can still be used by WAAS receivers using the alternate altimeter setting source.

NOTE-

Barometric Vertical Navigation (baro-VNAV). An RNAV system function which uses barometric altitude information from the aircraft's altimeter to compute and present a vertical guidance path to the pilot. The specified vertical path is computed as a geometric path, typically computed between two waypoints or an angle based computation from a single waypoint. Further guidance may be found in Advisory Circular 90-105.

5. A pilot adhering to the altitudes, flight paths, and weather minimums depicted on the IAP chart or vectors and altitudes issued by the radar controller, is assured of terrain and obstruction clearance and runway or airport alignment during approach for landing.

6. IAPs are designed to provide an IFR descent from the en route environment to a point where a safe landing can be made. They are prescribed and approved by appropriate civil or military authority to ensure a safe descent during instrument flight conditions at a specific airport. It is important that pilots understand these procedures and their use prior to attempting to fly instrument approaches.

7. TERPS criteria are provided for the following types of instrument approach procedures:

(a) **Precision Approach (PA).** An instrument approach based on a navigation system that provides course and glidepath deviation information meeting the precision standards of ICAO Annex 10. For example, PAR, ILS, and GLS are precision approaches.

(b) **Approach with Vertical Guidance (APV).** An instrument approach based on a navigation system that is not required to meet the precision approach standards of ICAO Annex 10 but provides course and glidepath deviation information. For example, Baro-VNAV, LDA with glidepath, LNAV/VNAV and LPV are APV approaches.

(c) **Nonprecision Approach (NPA).** An instrument approach based on a navigation system which provides course deviation information, but no glidepath deviation information. For example, VOR, NDB and LNAV. As noted in subparagraph k, Vertical Descent Angle (VDA) on Nonprecision Approaches, some approach procedures may provide a Vertical Descent Angle as an aid in flying a stabilized approach, without requiring its use in order to fly the procedure. This does not make the approach an APV procedure, since it must still be flown to an MDA and has not been evaluated with a glidepath.

b. The method used to depict prescribed altitudes on instrument approach charts differs according to techniques employed by different chart publishers. Prescribed altitudes may be depicted in four different configurations: minimum, maximum, mandatory, and recommended. The U.S. Government distributes charts produced by National Geospatial-Intelligence Agency (NGA) and FAA. Altitudes are depicted on these charts in the profile view with underscore, overscore, both or none to identify them as minimum, maximum, mandatory or recommended.

1. Minimum altitude will be depicted with the altitude value underscored. Aircraft are required to maintain altitude at or above the depicted value, e.g., 3000.

2. Maximum altitude will be depicted with the altitude value overscored. Aircraft are required to maintain altitude at or below the depicted value, e.g., 4000.

3. Mandatory altitude will be depicted with the altitude value both underscored and overscored. Aircraft are required to maintain altitude at the depicted value, e.g., 5000.

4. Recommended altitude will be depicted with no overscore or underscore. These altitudes are depicted for descent planning, e.g., 6000.

NOTE-

1. *Pilots are cautioned to adhere to altitudes as prescribed because, in certain instances, they may be used as the basis for vertical separation of aircraft by ATC. When a depicted*

altitude is specified in the ATC clearance, that altitude becomes mandatory as defined above.

2. *The ILS glide slope is intended to be intercepted at the published glide slope intercept altitude. This point marks the PFAF and is depicted by the "lightning bolt" symbol on U.S. Government charts. Intercepting the glide slope at this altitude marks the beginning of the final approach segment and ensures required obstacle clearance during descent from the glide slope intercept altitude to the lowest published decision altitude for the approach. Interception and tracking of the glide slope prior to the published glide slope interception altitude does not necessarily ensure that minimum, maximum, and/or mandatory altitudes published for any preceding fixes will be complied with during the descent. If the pilot chooses to track the glide slope prior to the glide slope interception altitude, they remain responsible for complying with published altitudes for any preceding stepdown fixes encountered during the subsequent descent.*

3. *Approaches used for simultaneous (parallel) independent and simultaneous close parallel operations procedurally require descending on the glideslope from the altitude at which the approach clearance is issued (refer to 5-4-15 and 5-4-16). For simultaneous close parallel (PRM) approaches, the Attention All Users Page (AAUP) may publish a note which indicates that descending on the glideslope/glidepath meets all crossing restrictions. However, if no such note is published, and for simultaneous independent approaches (4300 and greater runway separation) where an AAUP is not published, pilots are cautioned to monitor their descent on the glideslope/path outside of the PFAF to ensure compliance with published crossing restrictions during simultaneous operations.*

4. *When parallel approach courses are less than 2500 feet apart and reduced in-trail spacing is authorized for simultaneous dependent operations, a chart note will indicate that simultaneous operations require use of vertical guidance and that the pilot should maintain last assigned altitude until established on glide slope. These approaches procedurally require utilization of the ILS glide slope for wake turbulence mitigation. Pilots should not confuse these simultaneous dependent operations with*

(SOIA) simultaneous close parallel PRM approaches, where PRM appears in the approach title.

5. *Altitude restrictions depicted at stepdown fixes within the final approach segment are applicable only when flying a Non-Precision Approach to a straight-in or circling line of minima identified as a MDA(H). Stepdown fix altitude restrictions within the final approach segment do not apply to pilots using Precision Approach (ILS) or Approach with Vertical Guidance (LPV, LNAV/VNAV) lines of minima identified as a DA(H), since obstacle clearance on these approaches are based on the aircraft following the applicable vertical guidance. Pilots are responsible for adherence to stepdown fix altitude restrictions when outside the final approach segment (i.e., initial or intermediate segment), regardless of which type of procedure the pilot is flying. (See FIG 5-4-1.)*

c. Minimum Safe Altitudes (MSA) are published for emergency use on IAP charts. MSAs provide 1,000 feet of clearance over all obstacles, but do not necessarily assure acceptable navigation signal coverage. The MSA depiction on the plan view of an approach chart contains the identifier of the center point of the MSA, the applicable radius of the MSA, a depiction of the sector(s), and the minimum altitudes above mean sea level which provide obstacle clearance. For conventional navigation systems, the MSA is normally based on the primary omnidirectional facility on which the IAP is predicated, but may be based on the airport reference point (ARP) if no suitable facility is available. For RNAV approaches, the MSA is based on an RNAV waypoint. MSAs normally have a 25 NM radius; however, for conventional navigation systems, this radius may be expanded to 30 NM if necessary to encompass the airport landing surfaces. A single sector altitude is normally established, however when the MSA is based on a facility and it is necessary to obtain relief from obstacles, an MSA with up to four sectors may be established.

FIG 5-4-1
Instrument Approach Procedure Stepdown Fixes

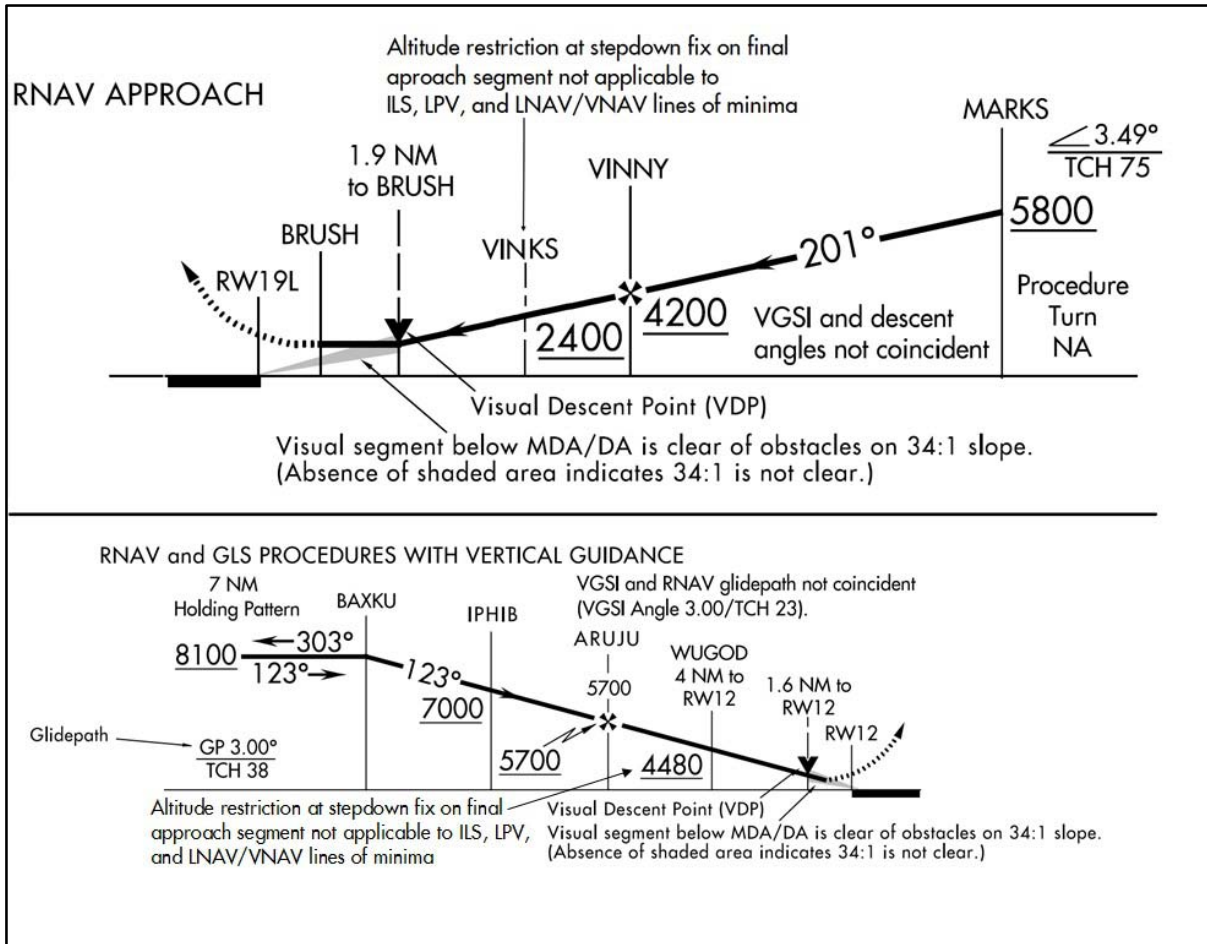

d. Terminal Arrival Area (TAA)

1. The TAA provides a transition from the en route structure to the terminal environment with little required pilot/air traffic control interface for aircraft equipped with Area Navigation (RNAV) systems. A TAA provides minimum altitudes with standard obstacle clearance when operating within the TAA boundaries. TAAs are primarily used on RNAV approaches but may be used on an ILS approach when RNAV is the sole means for navigation to the IF; however, they are not normally used in areas of heavy concentration of air traffic.

2. The basic design of the RNAV procedure underlying the TAA is normally the “T” design (also called the “Basic T”). The “T” design incorporates two IAFs plus a dual purpose IF/IAF that functions as both an intermediate fix and an initial approach fix.

The T configuration continues from the IF/IAF to the final approach fix (FAF) and then to the missed approach point (MAP). The two base leg IAFs are typically aligned in a straight-line perpendicular to the intermediate course connecting at the IF/IAF. A Hold-in-Lieu-of Procedure Turn (HILPT) is anchored at the IF/IAF and depicted on U.S. Government publications using the “hold-in-lieu-of-PT” holding pattern symbol. When the HILPT is necessary for course alignment and/or descent, the dual purpose IF/IAF serves as an IAF during the entry into the pattern. Following entry into the HILPT pattern and when flying a route or sector labeled “NoPT,” the dual-purpose fix serves as an IF, marking the beginning of the Intermediate Segment. See FIG 5-4-2 and FIG 5-4-3 for the Basic “T” TAA configuration.

FIG 5-4-2
Basic “T” Design

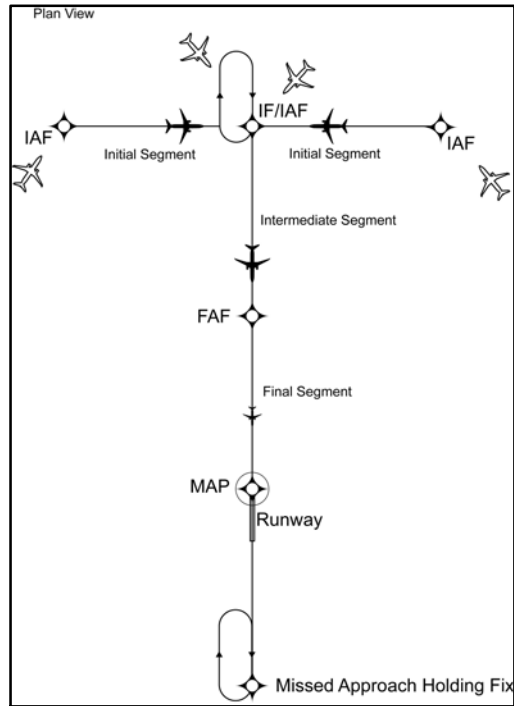
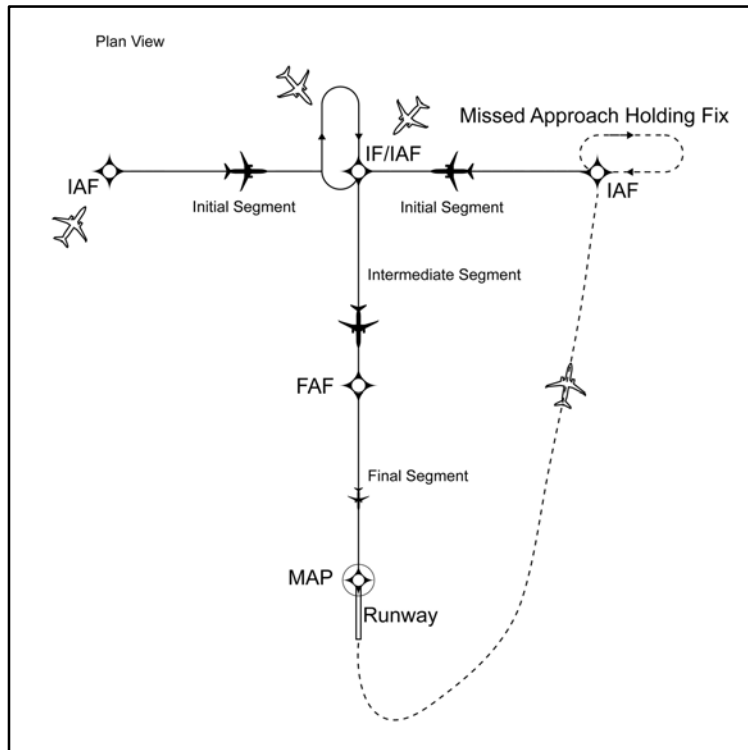

FIG 5-4-3
Basic “T” Design



3. The standard TAA based on the “T” design consists of three areas defined by the Initial Approach Fix (IAF) legs and the intermediate segment course beginning at the IF/IAF. These areas are called the straight-in, left-base, and right-base areas. (See FIG 5-4-4). TAA area lateral boundaries are identified by magnetic courses TO the IF/IAF. The straight-in area can be further divided into

pie-shaped sectors with the boundaries identified by magnetic courses TO the (IF/ IAF), and may contain stepdown sections defined by arcs based on RNAV distances from the IF/IAF. (See FIG 5-4-5). The right/left-base areas can only be subdivided using arcs based on RNAV distances from the IAFs for those areas.

FIG 5-4-4
TAA Area

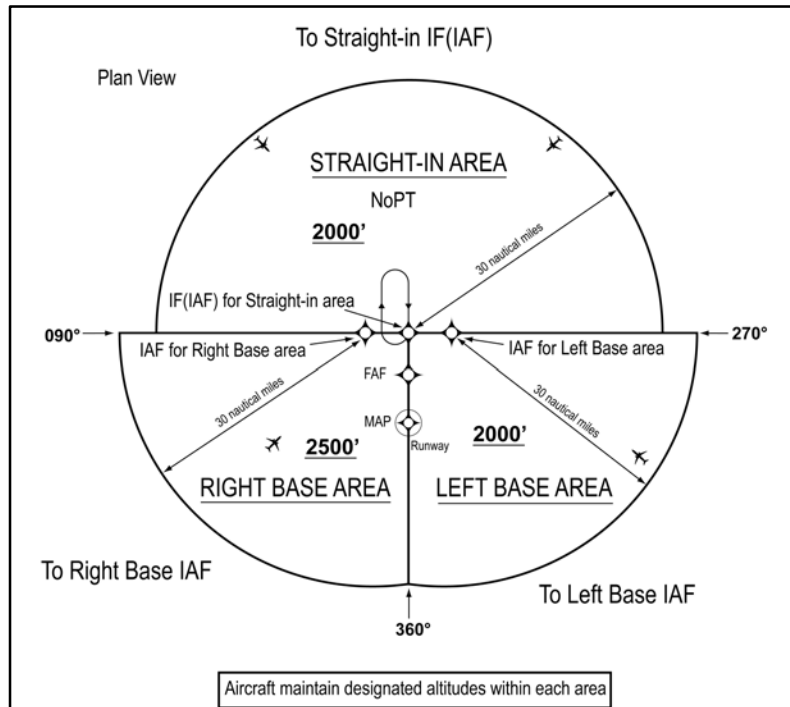

4. Entry from the terminal area onto the procedure is normally accomplished via a no procedure turn (NoPT) routing or via a course reversal maneuver. The published procedure will be annotated “NoPT” to indicate when the course reversal is not authorized when flying within a particular TAA sector. Otherwise, the pilot is expected to execute the course reversal under the provisions of 14 CFR Section 91.175. The pilot may elect to use the course reversal pattern when it is not required by the procedure, but must receive clearance from air traffic control before beginning the procedure.

(a) ATC should not clear an aircraft to the left base leg or right base leg IAF within a TAA at an intercept angle exceeding 90 degrees. Pilots must not execute the HILPT course reversal when the sector or procedure segment is labeled “NoPT.”

(b) ATC may clear aircraft direct to the fix labeled IF/IAF if the course to the IF/IAF is within the straight-in sector labeled “NoPT” and the intercept angle does not exceed 90 degrees. Pilots are expected to proceed direct to the IF/IAF and accomplish a straight-in approach. Do not execute HILPT course reversal. Pilots are also expected to fly the straight-in approach when ATC provides radar vectors and monitoring to the IF/IAF and issues a “straight-in” approach clearance; otherwise, the pilot *is expected* to execute the HILPT course reversal.

REFERENCE-

AIM, Paragraph 5-4-6, Approach Clearance

(c) On rare occasions, ATC may clear the aircraft for an approach at the airport without specifying the approach procedure by name or by a specific approach (for example, “cleared RNAV Runway 34 approach”) without specifying a particular IAF. In either case, the pilot should proceed

direct to the IAF or to the IF/IAF associated with the sector that the aircraft will enter the TAA and join the approach course from that point and if required by that sector (i.e., sector is not labeled “NoPT”), complete the HILPT course reversal.

NOTE-

If approaching with a TO bearing that is on a sector boundary, the pilot is expected to proceed in accordance with a “NoPT” routing unless otherwise instructed by ATC.

5. Altitudes published within the TAA replace the MSA altitude. However, unlike MSA altitudes the TAA altitudes are operationally usable altitudes. These altitudes provide at least 1,000 feet of obstacle clearance, more in mountainous areas. It is important that the pilot knows which area of the TAA the aircraft will enter in order to comply with the minimum altitude requirements. The pilot can determine which area of the TAA the aircraft will enter by determining the magnetic bearing of the aircraft TO the fix labeled IF/IAF. The bearing should then be compared to the published lateral boundary bearings that define the TAA areas. Do not use magnetic bearing to the right-base or left-base IAFs to determine position.

(a) An ATC clearance direct to an IAF or to the IF/IAF without an approach clearance does not

authorize a pilot to descend to a lower TAA altitude. If a pilot desires a lower altitude without an approach clearance, request the lower TAA altitude from ATC. Pilots not sure of the clearance should confirm their clearance with ATC or request a specific clearance. Pilots entering the TAA with two-way radio communications failure (14 CFR Section 91.185, IFR Operations: Two-way Radio Communications Failure), must maintain the highest altitude prescribed by Section 91.185(c)(2) until arriving at the appropriate IAF.

(b) Once cleared for the approach, pilots may descend in the TAA sector to the minimum altitude depicted within the defined area/subdivision, unless instructed otherwise by air traffic control. Pilots should plan their descent within the TAA to permit a normal descent from the IF/IAF to the FAF. In FIG 5-4-5, pilots within the left or right-base areas are expected to maintain a minimum altitude of 6,000 feet until within 17 NM of the associated IAF. After crossing the 17 NM arc, descent is authorized to the lower charted altitudes. Pilots approaching from the northwest are expected to maintain a minimum altitude of 6,000 feet, and when within 22 NM of the IF/IAF, descend to a minimum altitude of 2,000 feet MSL until crossing the IF/IAF.

**FIG 5-4-5
Sectored TAA Areas**

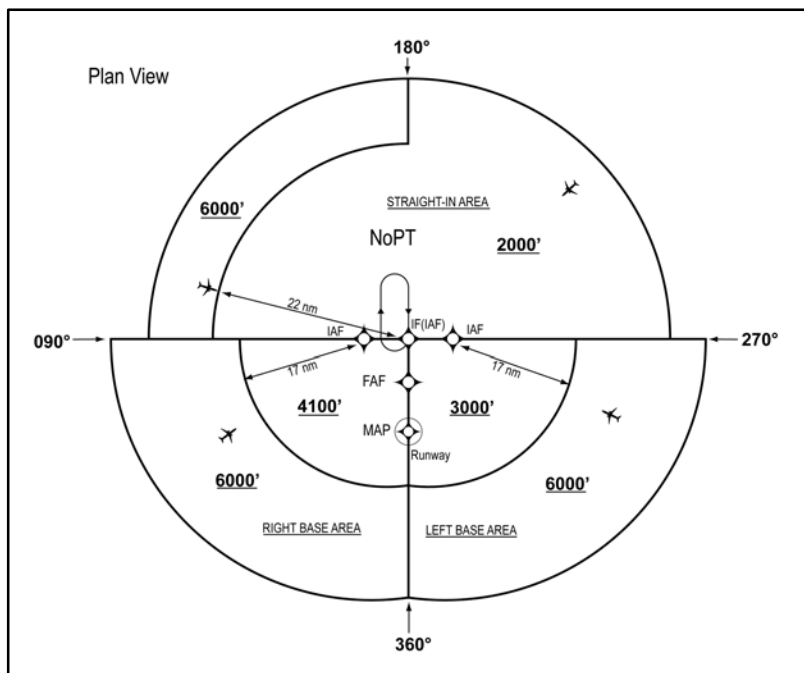

6. U.S. Government charts depict TAAs using icons located in the plan view outside the depiction of the actual approach procedure. (See FIG 5-4-6). Use of icons is necessary to avoid obscuring any portion of the “T” procedure (altitudes, courses, minimum altitudes, etc.). The icon for each TAA area will be located and oriented on the plan view with respect to the direction of arrival to the approach procedure, and

will show all TAA minimum altitudes and sector/radius subdivisions. The IAF for each area of the TAA is included on the icon where it appears on the approach to help the pilot orient the icon to the approach procedure. The IAF name and the distance of the TAA area boundary from the IAF are included on the outside arc of the TAA area icon.

FIG 5-4-6
RNAV (GPS) Approach Chart

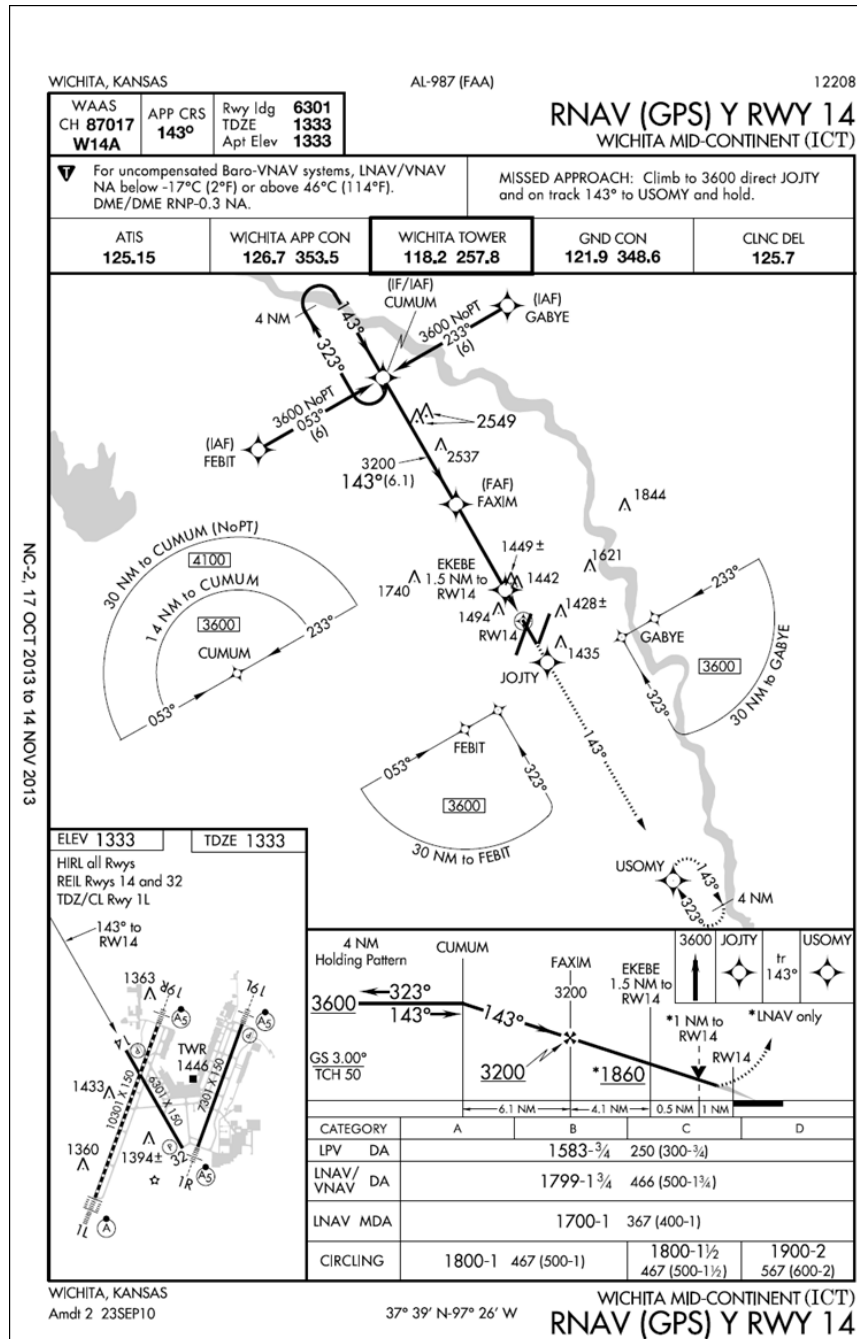

7. TAA's may be modified from the standard size and shape to accommodate operational or ATC requirements. Some areas may be eliminated, while the other areas are expanded. The "T" design may be modified by the procedure designers where required by terrain or ATC considerations. For instance, the "T" design may appear more like a regularly or irregularly shaped "Y," upside down "L," or an "I."

(a) FIG 5-4-7 depicts a TAA without a left base leg and right base leg. In this generalized example, pilots approaching on a bearing TO the IF/IAF from 271 clockwise to 089 are expected to execute a course reversal because the amount of turn required at the IF/IAF exceeds 90 degrees. The term "NoPT" will be annotated on the boundary of the TAA icon for the other portion of the TAA.

FIG 5-4-7
TAA with Left and Right Base Areas Eliminated

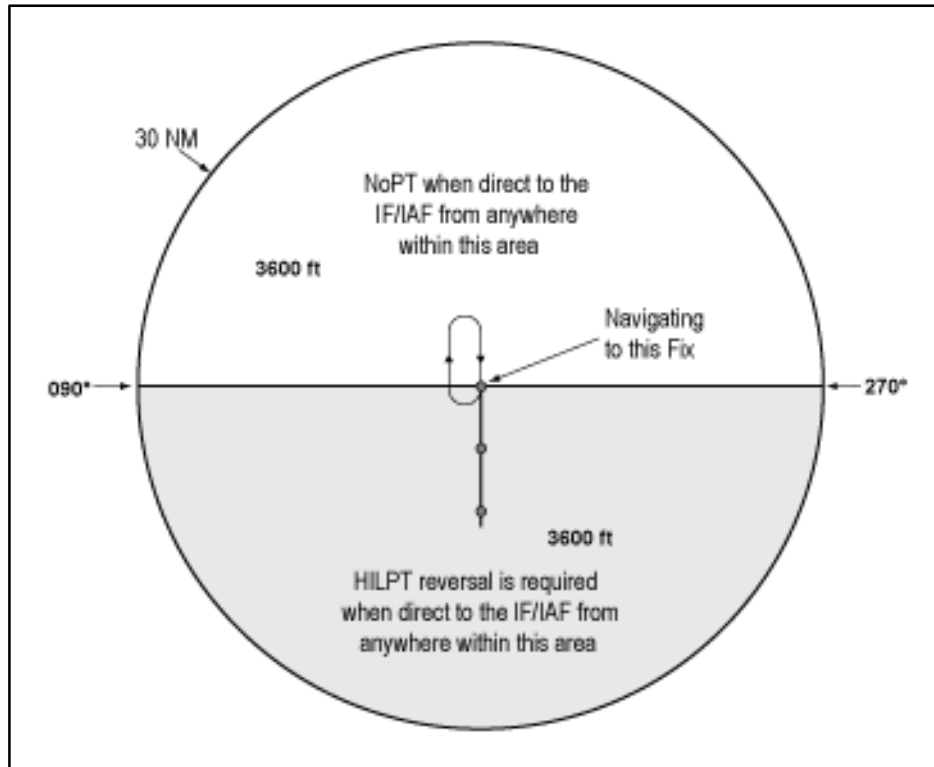

(b) FIG 5-4-8 depicts another TAA modification that pilots may encounter. In this generalized example, the left base area and part of the straight-in area have been eliminated. Pilots operating within the TAA between 210 clockwise to 360 bearing TO the IF/IAF are expected to proceed direct to the IF/IAF and then execute the course reversal in order to properly align the aircraft for entry onto the intermediate segment or to avoid an excessive descent rate. Aircraft operating in areas from 001 clockwise to 090 bearing TO the IF/IAF are expected

to proceed direct to the right base IAF and not execute course reversal maneuver. Aircraft cleared direct the IF/IAF by ATC in this sector will be expected to accomplish HILTP. Aircraft operating in areas 091 clockwise to 209 bearing TO the IF/IAF are expected to proceed direct to the IF/IAF and not execute the course reversal. These two areas are annotated "NoPT" at the TAA boundary of the icon in these areas when displayed on the approach chart's plan view.

FIG 5-4-8
TAA with Left Base and Part of Straight-In Area Eliminated

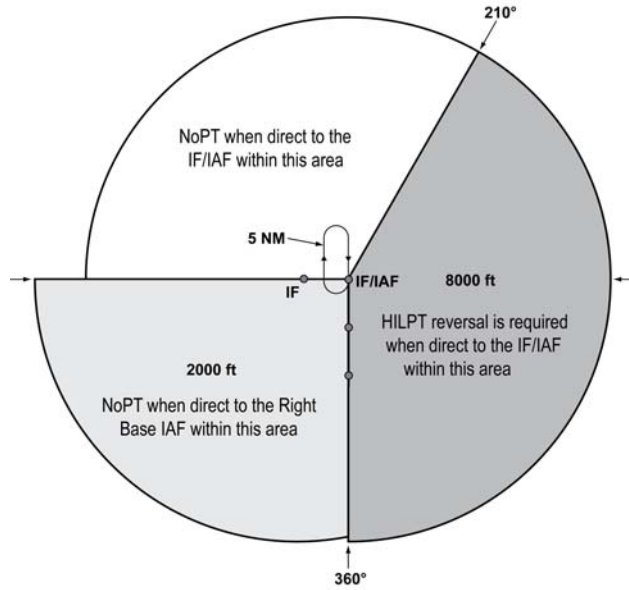

(c) FIG 5-4-9 depicts a TAA with right base leg and part of the straight-in area eliminated.

FIG 5-4-9
TAA with Right Base Eliminated

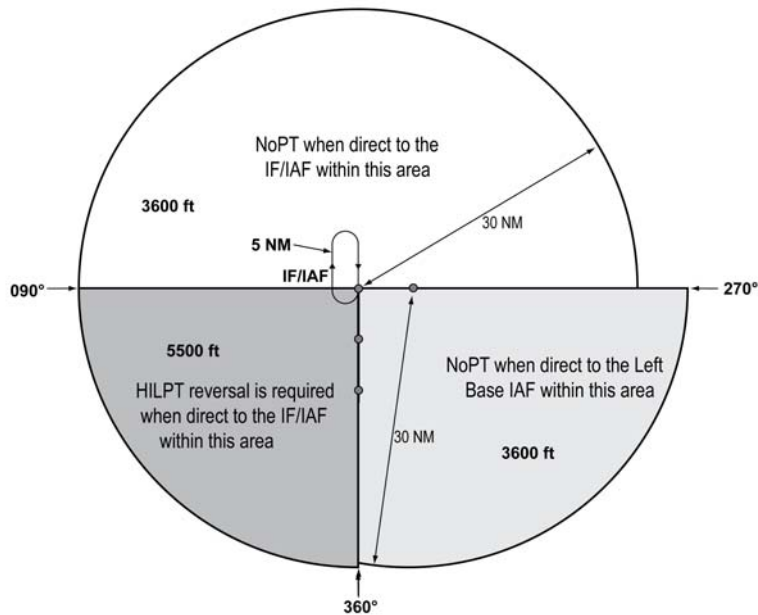

8. When an airway does not cross the lateral TAA boundaries, a feeder route will be established from an airway fix or NAVAID to the TAA boundary to provide a transition from the en route structure to the appropriate IAF. Each feeder route will terminate

at the TAA boundary and will be aligned along a path pointing to the associated IAF. Pilots should descend to the TAA altitude after crossing the TAA boundary and cleared for the approach by ATC. (See FIG 5-4-10).

FIG 5-4-10
Examples of a TAA with Feeders from an Airway

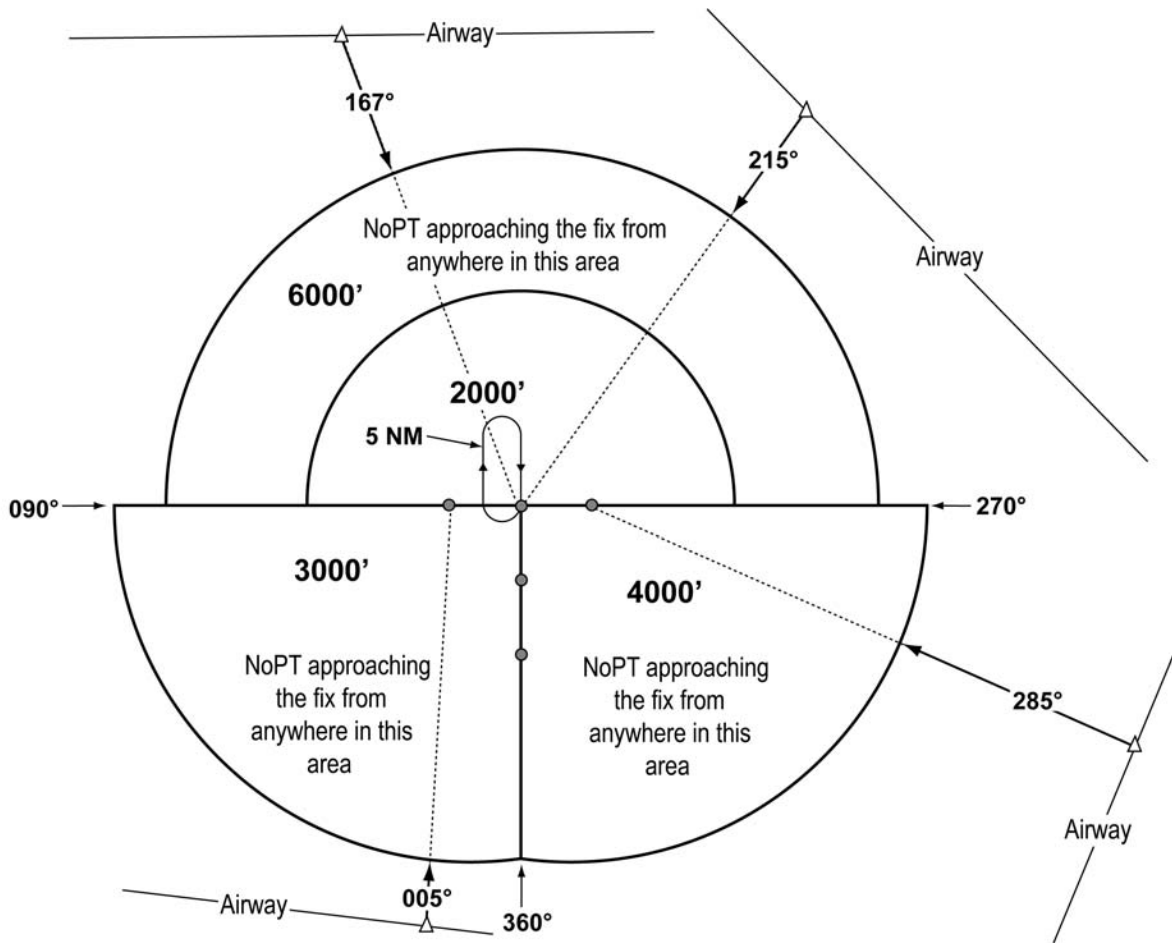

9. Each waypoint on the “T” is assigned a pronounceable 5-letter name, except the missed approach waypoint. These names are used for ATC communications, RNAV databases, and aeronautical

navigation products. The missed approach waypoint is assigned a pronounceable name when it is not located at the runway threshold.

FIG 5-4-11
Minimum Vectoring Altitude Charts

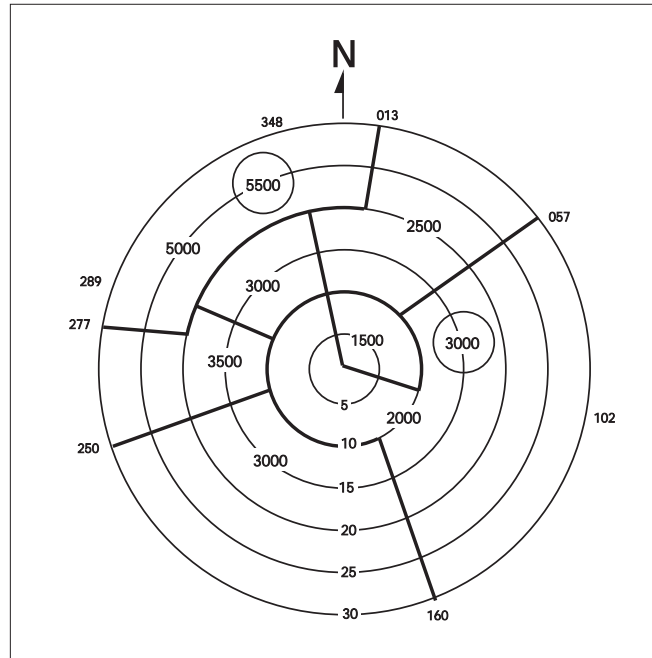

e. Minimum Vectoring Altitudes (MVAs) are established for use by ATC when radar ATC is exercised. MVA charts are prepared by air traffic facilities at locations where there are numerous different minimum IFR altitudes. Each MVA chart has sectors large enough to accommodate vectoring of aircraft within the sector at the MVA. Each sector boundary is at least 3 miles from the obstruction determining the MVA. To avoid a large sector with an excessively high MVA due to an isolated prominent obstruction, the obstruction may be enclosed in a buffer area whose boundaries are at least 3 miles from the obstruction. This is done to facilitate vectoring around the obstruction. (See FIG 5-4-11.)

1. The minimum vectoring altitude in each sector provides 1,000 feet above the highest obstacle in nonmountainous areas and 2,000 feet above the highest obstacle in designated mountainous areas. Where lower MVAs are required in designated mountainous areas to achieve compatibility with terminal routes or to permit vectoring to an IAP, 1,000 feet of obstacle clearance may be authorized with the use of Airport Surveillance Radar (ASR). The minimum vectoring altitude will provide at least 300 feet above the floor of controlled airspace.

NOTE-

OROCA is an off-route altitude which provides obstruction clearance with a 1,000 foot buffer in nonmountainous terrain areas and a 2,000 foot buffer in designated mountainous areas within the U.S. This altitude may not provide signal coverage from ground-based navigational aids, air traffic control radar, or communications coverage.

2. Because of differences in the areas considered for MVA, and those applied to other minimum altitudes, and the ability to isolate specific obstacles, some MVAs may be lower than the nonradar Minimum En Route Altitudes (MEAs), Minimum Obstruction Clearance Altitudes (MOCAs) or other minimum altitudes depicted on charts for a given location. While being radar vectored, IFR altitude assignments by ATC will be at or above MVA.

3. The MVA/MIA may be lower than the TAA minimum altitude. If ATC has assigned an altitude to an aircraft that is below the TAA minimum altitude, the aircraft will either be assigned an altitude to maintain until established on a segment of a published route or instrument approach procedure, or climbed to the TAA altitude.

f. Circling. Circling minimums charted on an RNAV (GPS) approach chart may be lower than the LNAV/VNAV line of minima, but never lower than the LNAV line of minima (straight-in approach). Pilots may safely perform the circling maneuver at

the circling published line of minima if the approach and circling maneuver is properly performed according to aircraft category and operational limitations.

FIG 5-4-12
Example of LNAV and Circling Minima Lower Than LNAV/VNAV DA.
Harrisburgh International RNAV (GPS) RWY 13

CATEGORY	A	B	C	D
LPV DA	558/24 250 (300 - 1/2)			
LNAV/VNAV DA	1572 - 5 1264 (1300 - 5)			
LNAV MDA	1180 / 24 872 (900 - 1/2)	1180 / 40 872 (900 - 3/4)	1180 / 2 872 (900 - 2)	1180 / 2 1/4 872 (900 - 2 1/4)
CIRCLING	1180 - 1 870 (900 - 1)	1180 - 1 1/4 870 (900 - 1 1/4)	1180 - 2 1/2 870 (900 - 2 1/2)	1180 - 2 3/4 870 (900 - 2 3/4)

FIG 5-4-13
Explanation of LNAV and/or Circling Minima Lower than LNAV/VNAV DA

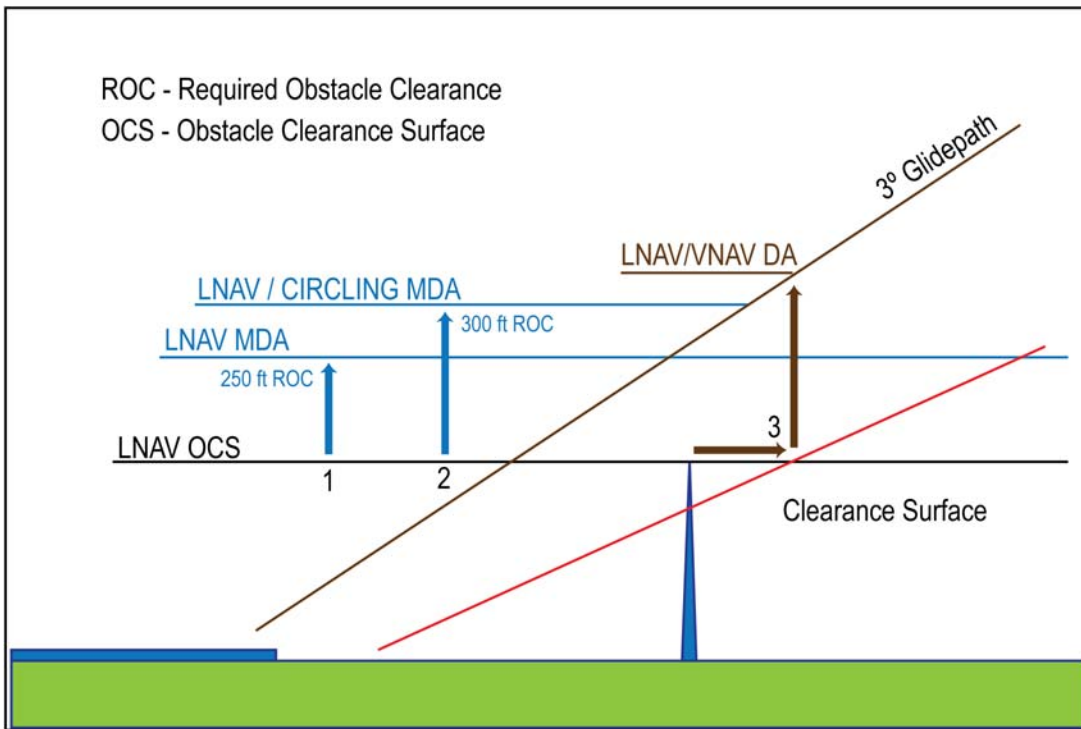

g. FIG 5-4-13 provides a visual representation of an obstacle evaluation and calculation of LNAV MDA, Circling MDA, LNAV/VNAV DA.

controlling obstacle used to determine LNAV MDA can be different than the controlling obstacle used in determining ROC for circling MDA. Other factors may force a number larger than 250 ft to be added to the LNAV OCS. The number is rounded up to the next higher 20 foot increment.

2. Circling MDA. The circling MDA will provide 300 foot obstacle clearance within the area considered for obstacle clearance and may be lower than the LNAV/VNAV DA, but never lower than the straight in LNAV MDA. This may occur when different controlling obstacles are used or when other controlling factors force the LNAV MDA to be higher than 250 feet above the LNAV OCS. In FIG 5-4-12, the required obstacle clearance for both the LNAV and Circle resulted in the same MDA, but lower than the LNAV/VNAV DA. FIG 5-4-13 provides an illustration of this type of situation.

3. Vertical guidance (LNAV/VNAV). A line is drawn horizontal at obstacle height until reaching the obstacle clearance surface (OCS). At the OCS, a vertical line is drawn until reaching the glide path. This is the DA for the approach. This method places the offending obstacle in front of the LNAV/VNAV DA so it can be seen and avoided. In some situations, this may result in the LNAV/VNAV DA being higher than the LNAV and/or Circling MDA.

h. The Visual Descent Point (VDP), identified by the symbol (V), is a defined point on the final approach course of a nonprecision straight-in approach procedure from which a stabilized visual descent from the MDA to the runway touchdown point may be commenced. The pilot should not descend below the MDA prior to reaching the VDP. The VDP will be identified by DME or RNAV along-track distance to the MAP. The VDP distance is based on the lowest MDA published on the IAP and harmonized with the angle of the visual glide slope indicator (VGSI) (if installed) or the procedure VDA (if no VGSI is installed). A VDP may not be published under certain circumstances which may result in a destabilized descent between the MDA and the runway touchdown point. Such circumstances include an obstacle penetrating the visual surface between the MDA and runway threshold, lack of distance measuring capability, or the procedure design prevents a VDP to be identified.

1. VGSI systems may be used as a visual aid to the pilot to determine if the aircraft is in a position to make a stabilized descent from the MDA. When the visibility is close to minimums, the VGSI may not be visible at the VDP due to its location beyond the MAP.

2. Pilots not equipped to receive the VDP should fly the approach procedure as though no VDP had been provided.

3. On a straight-in nonprecision IAP, descent below the MDA between the VDP and the MAP may be inadvisable or impossible. Aircraft speed, height above the runway, descent rate, amount of turn, and runway length are some of the factors which must be considered by the pilot to determine if a safe descent and landing can be accomplished.

i. A visual segment obstruction evaluation is accomplished during procedure design on all IAPs. Obstacles (both lighted and unlighted) are allowed to penetrate the visual segment obstacle identification surfaces. Identified obstacle penetrations may cause restrictions to instrument approach operations which may include an increased approach visibility requirement, not publishing a VDP, and/or prohibiting night instrument operations to the runway. There is no implicit obstacle protection from the MDA/DA to the touchdown point. Accordingly, it is the responsibility of the pilot to visually acquire and avoid obstacles below the MDA/DA during transition to landing.

1. Unlighted obstacle penetrations may result in prohibiting night instrument operations to the runway. A chart note will be published in the pilot briefing strip "Procedure NA at Night."

2. Use of a VGSI may be approved in lieu of obstruction lighting to restore night instrument operations to the runway. A chart note will be published in the pilot briefing strip "Straight-in Rwy XX at Night, operational VGSI required, remain on or above VGSI glidepath until threshold."

j. The highest obstacle (man-made, terrain, or vegetation) will be charted on the planview of an IAP. Other obstacles may be charted in either the planview or the airport sketch based on distance from the runway and available chart space. The elevation of the charted obstacle will be shown to the nearest foot above mean sea level. Obstacles without a verified accuracy are indicated by a \pm symbol following the elevation value.

k. Vertical Descent Angle (VDA). FAA policy is to publish a VDA/TCH on all nonprecision approaches except those published in conjunction with vertically guided minimums (i.e., ILS or LOC RWY XX) or no-FAF procedures without a step-down fix (i.e., on-airport VOR or NDB). A

VDA does not guarantee obstacle protection below the MDA in the visual segment. The presence of a VDA does not change any nonprecision approach requirements.

1. Obstacles may penetrate the obstacle identification surface below the MDA in the visual segment of an IAP that has a published VDA/TCH. When the VDA/TCH is not authorized due to an obstacle penetration that would require a pilot to deviate from the VDA between MDA and touchdown, the VDA/TCH will be replaced with the note “Visual Segment- Obstacles” in the profile view of the IAP (See FIG 5-4-14). Accordingly, pilots are advised to carefully review approach procedures to identify where the optimum stabilized descent to landing can be initiated. Pilots that follow the previously published descent angle, provided by the RNAV system, below the MDA on procedures with this note may encounter obstacles in the visual segment. Pilots must visually avoid any obstacles below the MDA.

(a) VDA/TCH data is furnished by FAA on the official source document for publication on IAP charts and for coding in the navigation database unless, as noted previously, replaced by the note “Visual Segment – Obstacles.”

(b) Commercial chart providers and navigation systems may publish or calculate a VDA/TCH even when the FAA does not provide such data. Pilots

are cautioned that they are responsible for obstacle avoidance in the visual segment regardless of the presence or absence of a VDA/TCH and associated navigation system advisory vertical guidance.

2. The threshold crossing height (TCH) used to compute the descent angle is published with the VDA. The VDA and TCH information are charted on the profile view of the IAP following the fix (FAF/stepdown) used to compute the VDA. If no PA/APV IAP is established to the same runway, the VDA will be equal to or higher than the glide path angle of the VGSI installed on the same runway provided it is within instrument procedure criteria. A chart note will indicate if the VGSI is not coincident with the VDA. Pilots must be aware that the published VDA is for advisory information only and not to be considered instrument procedure derived vertical guidance. The VDA solely offers an aid to help pilots establish a continuous, stabilized descent during final approach.

3. Pilots may use the published angle and estimated/actual groundspeed to find a target rate of descent from the rate of descent table published in the back of the U.S. Terminal Procedures Publication. This rate of descent can be flown with the Vertical Velocity Indicator (VVI) in order to use the VDA as an aid to flying a stabilized descent. No special equipment is required.

FIG 5-4-14
Example of a Chart Note

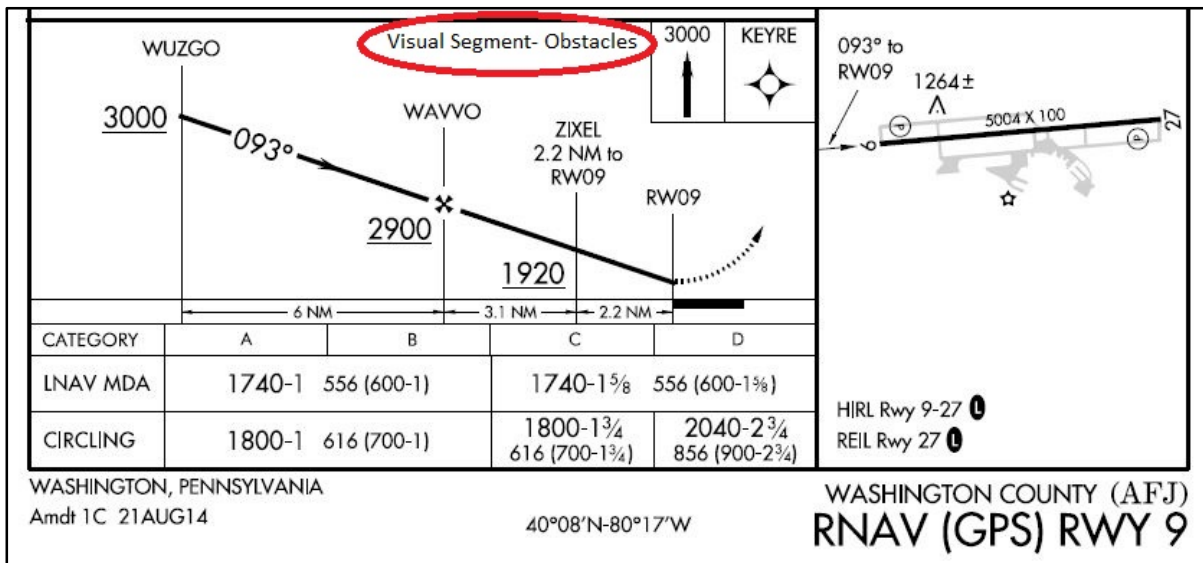

4. A straight-in aligned procedure may be restricted to circling only minimums when an excessive descent gradient necessitates. The descent angle between the FAF/stepdown fix and the Circling MDA must not exceed the maximum descent angle allowed by TERPS criteria. A published VDA on these procedures does not imply that landing straight ahead is recommended or even possible. The descent rate based on the VDA may exceed the capabilities of the aircraft and the pilot must determine how to best maneuver the aircraft within the circling area in order to land safely.

I. In isolated cases, an IAP may contain a published visual flight path. These procedures are annotated “Fly Visual to Airport” or “Fly Visual.” A dashed arrow indicating the visual flight path will be included in the profile and plan views with an approximate heading and distance to the end of the runway.

1. The depicted ground track associated with the “Fly Visual to Airport” segment should be flown as a “Dead Reckoning” course. When executing the “Fly Visual to Airport” segment, the flight visibility must not be less than that prescribed in the IAP; the pilot must remain clear of clouds and proceed to the airport maintaining visual contact with the ground. Altitude on the visual flight path is at the discretion of the pilot, and it is the responsibility of the pilot to visually acquire and avoid obstacles in the “Fly Visual to Airport” segment.

2. Missed approach obstacle clearance is assured only if the missed approach is commenced at the published MAP. Before initiating an IAP that contains a “Fly Visual to Airport” segment, the pilot should have preplanned climb out options based on aircraft performance and terrain features. Obstacle clearance is the responsibility of the pilot when the approach is continued beyond the MAP.

NOTE—

The FAA Administrator retains the authority to approve instrument approach procedures where the pilot may not necessarily have one of the visual references specified in 14 CFR § 91.175 and related rules. It is not a function of procedure design to ensure compliance with § 91.175. The annotation “Fly Visual to Airport” provides relief from § 91.175 requirements that the pilot have distinctly visible and identifiable visual references prior to descent below MDA/DA.

m. Area Navigation (RNAV) Instrument Approach Charts. Reliance on RNAV systems for instrument operations is becoming more commonplace as new systems such as GPS and augmented GPS such as the Wide Area Augmentation System (WAAS) are developed and deployed. In order to support full integration of RNAV procedures into the National Airspace System (NAS), the FAA developed a new charting format for IAPs (See FIG 5–4–6). This format avoids unnecessary duplication and proliferation of instrument approach charts. The original stand alone GPS charts, titled simply “GPS,” are being converted to the newer format as the procedures are revised. One reason for the revision is the addition of WAAS based minima to the approach chart. The reformatted approach chart is titled “RNAV (GPS) RWY XX.” Up to four lines of minima are included on these charts. Ground Based Augmentation System (GBAS) Landing System (GLS) was a placeholder for future WAAS and LAAS minima, and the minima was always listed as N/A. The GLS minima line has now been replaced by the WAAS LPV (Localizer Performance with Vertical Guidance) minima on most RNAV (GPS) charts. LNAV/VNAV (lateral navigation/vertical navigation) was added to support both WAAS electronic vertical guidance and Barometric VNAV. LPV and LNAV/VNAV are both APV procedures as described in paragraph 5–4–5a7. The original GPS minima, titled “S–XX,” for straight in runway XX, is retitled LNAV (lateral navigation). Circling minima may also be published. A new type of nonprecision WAAS minima will also be published on this chart and titled LP (localizer performance). LP will be published in locations where vertically guided minima cannot be provided due to terrain and obstacles and therefore, no LPV or LNAV/VNAV minima will be published. GBAS procedures are published on a separate chart and the GLS minima line is to be used only for GBAS. ATC clearance for the RNAV procedure authorizes a properly certified pilot to utilize any minimums for which the aircraft is certified (for example, a WAAS equipped aircraft utilizes the LPV or LP minima but a GPS only aircraft may not). The RNAV chart includes information formatted for quick reference by the pilot or flight crew at the top of the chart. This portion of the chart, developed based on a study by the Department of Transportation, Volpe National Transportation System Center, is commonly referred to as the pilot briefing.

1. The minima lines are:

(a) **GLS.** “GLS” is the acronym for GBAS Landing System. The U.S. version of GBAS has traditionally been referred to as LAAS. The worldwide community has adopted GBAS as the official term for this type of navigation system. To coincide with international terminology, the FAA is also adopting the term GBAS to be consistent with the international community. This line was originally published as a placeholder for both WAAS and LAAS minima and marked as N/A since no minima was published. As the concepts for GBAS and WAAS procedure publication have evolved, GLS will now be used only for GBAS minima, which will be on a separate approach chart. Most RNAV(GPS) approach charts have had the GLS minima line replaced by a WAAS LPV line of minima.

(b) **LPV.** “LPV” is the acronym for localizer performance with vertical guidance. RNAV (GPS) approaches to LPV lines of minima take advantage of the improved accuracy of WAAS lateral and vertical guidance to provide an approach that is very similar to a Category I Instrument Landing System (ILS). The approach to LPV line of minima is designed for angular guidance with increasing sensitivity as the aircraft gets closer to the runway. The sensitivities are nearly identical to those of the ILS at similar distances. This was done intentionally to allow the skills required to proficiently fly an ILS to readily transfer to flying RNAV (GPS) approaches to the LPV line of minima. Just as with an ILS, the LPV has vertical guidance and is flown to a DA. Aircraft can fly this minima line with a statement in the Aircraft Flight Manual that the installed equipment supports LPV approaches. This includes Class 3 and 4 TSO–C146 GPS/WAAS equipment.

(c) **LNAV/VNAV.** LNAV/VNAV identifies APV minimums developed to accommodate an RNAV IAP with vertical guidance, usually provided by approach certified Baro–VNAV, but with lateral and vertical integrity limits larger than a precision approach or LPV. LNAV stands for Lateral Navigation; VNAV stands for Vertical Navigation. This minima line can be flown by aircraft with a statement in the Aircraft Flight Manual that the installed equipment supports GPS approaches and has an approach–approved barometric VNAV, or if the aircraft has been demonstrated to support LNAV/VNAV approaches. This includes Class 2, 3

and 4 TSO–C146 GPS/WAAS equipment. Aircraft using LNAV/VNAV minimums will descend to landing via an internally generated descent path based on satellite or other approach approved VNAV systems. Since electronic vertical guidance is provided, the minima will be published as a DA. Other navigation systems may be specifically authorized to use this line of minima. (See Section A, Terms/Landing Minima Data, of the U.S. Terminal Procedures books.)

(d) **LP.** “LP” is the acronym for localizer performance. Approaches to LP lines of minima take advantage of the improved accuracy of WAAS to provide approaches, with lateral guidance and angular guidance. Angular guidance does not refer to a glideslope angle but rather to the increased lateral sensitivity as the aircraft gets closer to the runway, similar to localizer approaches. However, the LP line of minima is a Minimum Descent Altitude (MDA) rather than a DA (H). Procedures with LP lines of minima will not be published with another approach that contains approved vertical guidance (LNAV/VNAV or LPV). It is possible to have LP and LNAV published on the same approach chart but LP will only be published if it provides lower minima than an LNAV line of minima. LP is not a fail–down mode for LPV. LP will only be published if terrain, obstructions, or some other reason prevent publishing a vertically guided procedure. WAAS avionics may provide GNSS–based advisory vertical guidance during an approach to an LP line of minima. Barometric altimeter information remains the primary altitude reference for complying with any altitude restrictions. WAAS equipment may not support LP, even if it supports LPV, if it was approved before TSO–C145b and TSO–C146b. Receivers approved under previous TSOs may require an upgrade by the manufacturer in order to be used to fly to LP minima. Receivers approved for LP must have a statement in the approved Flight Manual or Supplemental Flight Manual including LP as one of the approved approach types.

(e) **LNAV.** This minima is for lateral navigation only, and the approach minimum altitude will be published as a minimum descent altitude (MDA). LNAV provides the same level of service as the present GPS stand alone approaches. LNAV minimums support the following navigation systems: WAAS, when the navigation solution will not support vertical navigation; and, GPS navigation systems

which are presently authorized to conduct GPS approaches.

NOTE—

GPS receivers approved for approach operations in accordance with: AC 20–138, Airworthiness Approval of Positioning and Navigation Systems, qualify for this minima. WAAS navigation equipment must be approved in accordance with the requirements specified in TSO–C145() or TSO–C146() and installed in accordance with Advisory Circular AC 20–138.

2. Other systems may be authorized to utilize these approaches. See the description in Section A of the U.S. Terminal Procedures books for details. Operational approval must also be obtained for Baro–VNAV systems to operate to the LNAV/VNAV minimums. Baro–VNAV may not be authorized on some approaches due to other factors, such as no local altimeter source being available. Baro–VNAV is not authorized on LPV procedures. Pilots are directed to their local Flight Standards District Office (FSDO) for additional information.

NOTE—

RNAV and Baro–VNAV systems must have a manufacturer supplied electronic database which must include the waypoints, altitudes, and vertical data for the procedure to be flown. The system must be able to retrieve the procedure by name from the aircraft navigation database, not just as a manually entered series of waypoints.

3. ILS or RNAV (GPS) charts.

(a) Some RNAV (GPS) charts will also contain an ILS line of minima to make use of the ILS precision final in conjunction with the RNAV GPS capabilities for the portions of the procedure prior to the final approach segment and for the missed approach. Obstacle clearance for the portions of the procedure other than the final approach segment is still based on GPS criteria.

NOTE—

Some GPS receiver installations inhibit GPS navigation whenever ANY ILS frequency is tuned. Pilots flying aircraft with receivers installed in this manner must wait until they are on the intermediate segment of the procedure prior to the PFAF (PFAF is the active waypoint) to tune the ILS frequency and must tune the ILS back to a VOR frequency in order to fly the GPS based missed approach.

(b) **Charting.** There are charting differences between ILS, RNAV (GPS), and GLS approaches.

(1) The LAAS procedure is titled “GLS RWY XX” on the approach chart.

(2) The VDB provides information to the airborne receiver where the guidance is synthesized.

(3) The LAAS procedure is identified by a four alpha–numeric character field referred to as the RPI or approach ID and is similar to the IDENT feature of the ILS.

(4) The RPI is charted.

(5) Most RNAV(GPS) approach charts have had the GLS (NA) minima line replaced by an LPV line of minima.

(6) Since the concepts for LAAS and WAAS procedure publication have evolved, GLS will now be used only for LAAS minima, which will be on a separate approach chart.

4. Required Navigation Performance (RNP).

(a) Pilots are advised to refer to the “TERMS/LANDING MINIMUMS DATA” (Section A) of the U.S. Government Terminal Procedures books for aircraft approach eligibility requirements by specific RNP level requirements.

(b) Some aircraft have RNP approval in their AFM without a GPS sensor. The lowest level of sensors that the FAA will support for RNP service is DME/DME. However, necessary DME signal may not be available at the airport of intended operations. For those locations having an RNAV chart published with LNAV/VNAV minimums, a procedure note may be provided such as “DME/DME RNP–0.3 NA.” This means that RNP aircraft dependent on DME/DME to achieve RNP–0.3 are not authorized to conduct this approach. Where DME facility availability is a factor, the note may read “DME/DME RNP–0.3 Authorized; ABC and XYZ Required.” This means that ABC and XYZ facilities have been determined by flight inspection to be required in the navigation solution to assure RNP–0.3. VOR/DME updating must not be used for approach procedures.

5. Chart Terminology.

(a) Decision Altitude (DA) replaces the familiar term Decision Height (DH). DA conforms to the international convention where altitudes relate to MSL and heights relate to AGL. DA will eventually be published for other types of instrument approach procedures with vertical guidance, as well. DA indicates to the pilot that the published descent profile is flown to the DA (MSL), where a missed approach will be initiated if visual references for landing are not

established. Obstacle clearance is provided to allow a momentary descent below DA while transitioning from the final approach to the missed approach. The aircraft is expected to follow the missed instructions while continuing along the published final approach course to at least the published runway threshold waypoint or MAP (if not at the threshold) before executing any turns.

(b) Minimum Descent Altitude (MDA) has been in use for many years, and will continue to be used for the LNAV only and circling procedures.

(c) Threshold Crossing Height (TCH) has been traditionally used in “precision” approaches as the height of the glide slope above threshold. With publication of LNAV/VNAV minimums and RNAV descent angles, including graphically depicted descent profiles, TCH also applies to the height of the “descent angle,” or glidepath, at the threshold. Unless otherwise required for larger type aircraft which may be using the IAP, the typical TCH is 30 to 50 feet.

6. The MINIMA FORMAT will also change slightly.

(a) Each line of minima on the RNAV IAP is titled to reflect the level of service available; e.g., GLS, LPV, LNAV/VNAV, LP, and LNAV. CIRCLING minima will also be provided.

(b) The minima title box indicates the nature of the minimum altitude for the IAP. For example:

(1) DA will be published next to the minima line title for minimums supporting vertical guidance such as for GLS, LPV or LNAV/VNAV.

(2) MDA will be published as the minima line on approaches with lateral guidance only, LNAV, or LP. Descent below the MDA must meet the conditions stated in 14 CFR Section 91.175.

(3) Where two or more systems, such as LPV and LNAV/VNAV, share the same minima, each line of minima will be displayed separately.

7. Chart Symbolology changed slightly to include:

(a) **Descent Profile.** The published descent profile and a graphical depiction of the vertical path to the runway will be shown. Graphical depiction of the RNAV vertical guidance will differ from the traditional depiction of an ILS glide slope (feather)

through the use of a shorter vertical track beginning at the decision altitude.

(1) It is FAA policy to design IAPs with minimum altitudes established at fixes/waypoints to achieve optimum stabilized (constant rate) descents within each procedure segment. This design can enhance the safety of the operations and contribute toward reduction in the occurrence of controlled flight into terrain (CFIT) accidents. Additionally, the National Transportation Safety Board (NTSB) recently emphasized that pilots could benefit from publication of the appropriate IAP descent angle for a stabilized descent on final approach. The RNAV IAP format includes the descent angle to the hundredth of a degree; e.g., 3.00 degrees. The angle will be provided in the graphically depicted descent profile.

(2) The stabilized approach may be performed by reference to vertical navigation information provided by WAAS or LNAV/VNAV systems; or for LNAV-only systems, by the pilot determining the appropriate aircraft attitude/groundspeed combination to attain a constant rate descent which best emulates the published angle. To aid the pilot, U.S. Government Terminal Procedures Publication charts publish an expanded Rate of Descent Table on the inside of the back hard cover for use in planning and executing precision descents under known or approximate groundspeed conditions.

(b) **Visual Descent Point (VDP).** A VDP will be published on most RNAV IAPs. VDPs apply only to aircraft utilizing LP or LNAV minima, not LPV or LNAV/VNAV minimums.

(c) **Missed Approach Symbolology.** In order to make missed approach guidance more readily understood, a method has been developed to display missed approach guidance in the profile view through the use of quick reference icons. Due to limited space in the profile area, only four or fewer icons can be shown. However, the icons may not provide representation of the entire missed approach procedure. The entire set of textual missed approach instructions are provided at the top of the approach chart in the pilot briefing. (See FIG 5-4-6).

(d) **Waypoints.** All RNAV or GPS stand-alone IAPs are flown using data pertaining to the particular IAP obtained from an onboard database, including the sequence of all WPs used for the

approach and missed approach, except that step down waypoints may not be included in some TSO-C129 receiver databases. Included in the database, in most receivers, is coding that informs the navigation system of which WPs are fly-over (FO) or fly-by (FB). The navigation system may provide guidance appropriately – including leading the turn prior to a fly-by WP; or causing overflight of a fly-over WP. Where the navigation system does not provide such guidance, the pilot must accomplish the turn lead or waypoint overflight manually. Chart symbology for the FB WP provides pilot awareness of expected actions. Refer to the legend of the U.S. Terminal Procedures books.

(e) TAAs are described in paragraph 5-4-5d, Terminal Arrival Area (TAA). When published, the RNAV chart depicts the TAA areas through the use of “icons” representing each TAA area associated with the RNAV procedure (See FIG 5-4-6). These icons are depicted in the plan view of the approach chart, generally arranged on the chart in accordance with their position relative to the aircraft’s arrival from the en route structure. The WP, to which navigation is appropriate and expected within each specific TAA area, will be named and depicted on the associated TAA icon. Each depicted named WP is the IAF for arrivals from within that area. TAAs may not be used on all RNAV procedures because of airspace congestion or other reasons.

(f) Hot and Cold Temperature Limitations. A minimum and maximum temperature limitation is published on procedures which authorize Baro-VNAV operation. These temperatures represent the airport temperature above or below which Baro-VNAV is not authorized to LNAV/VNAV minimums. As an example, the limitation will read: “Uncompensated Baro-VNAV NA below -8°C ($+18^{\circ}\text{F}$) or above 47°C (117°F).” This information will be found in the upper left hand box of the pilot briefing. When the temperature is above the high temperature or below the low temperature limit, Baro-VNAV may be used to provide a stabilized descent to the LNAV MDA; however, extra caution should be used in the visual segment to ensure a vertical correction is not required. If the VGSI is aligned with the published glidepath, and the aircraft instruments indicate on glidepath, an above or below glidepath indication on the VGSI may indicate that temperature error is causing deviations to the glidepath. These deviations

should be considered if the approach is continued below the MDA.

NOTE-

Many systems which apply Baro-VNAV temperature compensation only correct for cold temperature. In this case, the high temperature limitation still applies. Also, temperature compensation may require activation by maintenance personnel during installation in order to be functional, even though the system has the feature. Some systems may have a temperature correction capability, but correct the Baro-altimeter all the time, rather than just on the final, which would create conflicts with other aircraft if the feature were activated. Pilots should be aware of compensation capabilities of the system prior to disregarding the temperature limitations.

NOTE-

Temperature limitations do not apply to flying the LNAV/VNAV line of minima using approach certified WAAS receivers when LPV or LNAV/VNAV are annunciated to be available.

(g) WAAS Channel Number/Approach ID.

The WAAS Channel Number is an optional equipment capability that allows the use of a 5-digit number to select a specific final approach segment without using the menu method. The Approach ID is an airport unique 4-character combination for verifying the selection and extraction of the correct final approach segment information from the aircraft database. It is similar to the ILS ident, but displayed visually rather than aurally. The Approach ID consists of the letter W for WAAS, the runway number, and a letter other than L, C or R, which could be confused with Left, Center and Right, e.g., W35A. Approach IDs are assigned in the order that WAAS approaches are built to that runway number at that airport. The WAAS Channel Number and Approach ID are displayed in the upper left corner of the approach procedure pilot briefing.

(h) At locations where outages of WAAS vertical guidance may occur daily due to initial system limitations, a negative W symbol (**W**) will be placed on RNAV (GPS) approach charts. Many of these outages will be very short in duration, but may result in the disruption of the vertical portion of the approach. The **W** symbol indicates that NOTAMs or Air Traffic advisories are not provided for outages which occur in the WAAS LNAV/VNAV or LPV vertical service. Use LNAV or circling minima for flight planning at these locations, whether as a destination or alternate. For flight operations at these locations, when the WAAS avionics indicate that

LNAV/VNAV or LPV service is available, then vertical guidance may be used to complete the approach using the displayed level of service. Should an outage occur during the procedure, reversion to LNAV minima may be required. As the WAAS coverage is expanded, the **W** will be removed.

NOTE—

Properly trained and approved, as required, TSO-C145() and TSO-C146() equipped users (WAAS users) with and using approved baro-VNAV equipment may plan for LNAV/VNAV DA at an alternate airport. Specifically authorized WAAS users with and using approved baro-VNAV equipment may also plan for RNP 0.3 DA at the alternate airport as long as the pilot has verified RNP availability through an approved prediction program.

5-4-6. Approach Clearance

a. An aircraft which has been cleared to a holding fix and subsequently “cleared . . . approach” has not received new routing. Even though clearance for the approach may have been issued prior to the aircraft reaching the holding fix, ATC would expect the pilot to proceed via the holding fix (his/her last assigned route), and the feeder route associated with that fix (if a feeder route is published on the approach chart) to the initial approach fix (IAF) to commence the approach. *WHEN CLEARED FOR THE APPROACH, THE PUBLISHED OFF AIRWAY (FEEDER) ROUTES THAT LEAD FROM THE EN ROUTE STRUCTURE TO THE IAF ARE PART OF THE APPROACH CLEARANCE.*

b. If a feeder route to an IAF begins at a fix located along the route of flight prior to reaching the holding fix, and clearance for an approach is issued, a pilot should commence the approach via the published feeder route; i.e., the aircraft would not be expected to overfly the feeder route and return to it. The pilot is expected to commence the approach in a similar manner at the IAF, if the IAF for the procedure is located along the route of flight to the holding fix.

c. If a route of flight directly to the initial approach fix is desired, it should be so stated by the controller with phraseology to include the words “direct . . .,” “proceed direct” or a similar phrase which the pilot can interpret without question. When uncertain of the clearance, immediately query ATC as to what route of flight is desired.

d. The name of an instrument approach, as published, is used to identify the approach, even

though a component of the approach aid, such as the glideslope on an Instrument Landing System, is inoperative or unreliable. The controller will use the name of the approach as published, but must advise the aircraft at the time an approach clearance is issued that the inoperative or unreliable approach aid component is unusable, except when the title of the published approach procedures otherwise allows; for example, ILS Rwy 05 or LOC Rwy 05.

e. The following applies to aircraft on radar vectors and/or cleared “direct to” in conjunction with an approach clearance:

- 1.** Maintain the last altitude assigned by ATC until the aircraft is established on a published segment of a transition route, or approach procedure segment, or other published route, for which a lower altitude is published on the chart. If already on an established route, or approach or arrival segment, you may descend to whatever minimum altitude is listed for that route or segment.

- 2.** Continue on the vector heading until intercepting the next published ground track applicable to the approach clearance.

- 3.** Once reaching the final approach fix via the published segments, the pilot may continue on approach to a landing.

- 4.** If proceeding to an IAF with a published course reversal (procedure turn or hold-in-lieu of PT pattern), except when cleared for a straight in approach by ATC, the pilot must execute the procedure turn/hold-in-lieu of PT, and complete the approach.

- 5.** If cleared to an IAF/IF via a NoPT route, or no procedure turn/hold-in-lieu of PT is published, continue with the published approach.

- 6.** In addition to the above, RNAV aircraft may be issued a clearance direct to the IAF/IF at intercept angles not greater than 90 degrees for both conventional and RNAV instrument approaches. Controllers may issue a heading or a course direct to a fix between the IF and FAF at intercept angles not greater than 30 degrees for both conventional and RNAV instrument approaches. In all cases, controllers will assign altitudes that ensure obstacle clearance and will permit a normal descent to the FAF. When clearing aircraft direct to the IF, ATC will radar monitor the aircraft until the IF and will advise the pilot to expect clearance direct to the IF at least 5

miles from the fix. ATC must issue a straight-in approach clearance when clearing an aircraft direct to an IAF/IF with a procedure turn or hold-in-lieu of a procedure turn, and ATC does not want the aircraft to execute the course reversal.

NOTE—

Refer to 14 CFR 91.175 (i).

7. RNAV aircraft may be issued a clearance direct to the FAF that is also charted as an IAF, in which case the pilot is expected to execute the depicted procedure turn or hold-in-lieu of procedure turn. ATC will not issue a straight-in approach clearance. If the pilot desires a straight-in approach, they must request vectors to the final approach course outside of the FAF or fly a published “NoPT” route. When visual approaches are in use, ATC may clear an aircraft direct to the FAF.

NOTE—

1. In anticipation of a clearance by ATC to any fix published on an instrument approach procedure, pilots of RNAV aircraft are advised to select an appropriate IAF or feeder fix when loading an instrument approach procedure into the RNAV system.

2. Selection of “Vectors-to-Final” or “Vectors” option for an instrument approach may prevent approach fixes located outside of the FAF from being loaded into an RNAV system. Therefore, the selection of these options is discouraged due to increased workload for pilots to reprogram the navigation system.

f. An RF leg is defined as a constant radius circular path around a defined turn center that starts and terminates at a fix. An RF leg may be published as part of a procedure. Since not all aircraft have the capability to fly these leg types, pilots are responsible for knowing if they can conduct an RNAV approach with an RF leg. Requirements for RF legs will be indicated on the approach chart in the notes section or at the applicable initial approach fix. Controllers will clear RNAV-equipped aircraft for instrument approach procedures containing RF legs:

1. Via published transitions, or
2. In accordance with paragraph e6 above, and
3. ATC will not clear aircraft direct to any waypoint beginning or within an RF leg, and will not assign fix/waypoint crossing speeds in excess of charted speed restrictions.

EXAMPLE—

Controllers will not clear aircraft direct to THIRD because

that waypoint begins the RF leg, and aircraft cannot be vectored or cleared to TURN or vectored to intercept the approach segment at any point between THIRD and FORTH because this is the RF leg. (See FIG 5-4-15.)

g. When necessary to cancel a previously issued approach clearance, the controller will advise the pilot “Cancel Approach Clearance” followed by any additional instructions when applicable.

5-4-7. Instrument Approach Procedures

a. Aircraft approach category means a grouping of aircraft based on a speed of V_{REF} , if specified, or if V_{REF} is not specified, $1.3 V_{SO}$ at the maximum certified landing weight. V_{REF} , V_{SO} , and the maximum certified landing weight are those values as established for the aircraft by the certification authority of the country of registry. A pilot must use the minima corresponding to the category determined during certification or higher. Helicopters may use Category A minima. If it is necessary to operate at a speed in excess of the upper limit of the speed range for an aircraft’s category, the minimums for the higher category must be used. For example, an airplane which fits into Category B, but is circling to land at a speed of 145 knots, must use the approach Category D minimums. As an additional example, a Category A airplane (or helicopter) which is operating at 130 knots on a straight-in approach must use the approach Category C minimums. See the following category limits:

1. Category A: Speed less than 91 knots.
2. Category B: Speed 91 knots or more but less than 121 knots.
3. Category C: Speed 121 knots or more but less than 141 knots.
4. Category D: Speed 141 knots or more but less than 166 knots.
5. Category E: Speed 166 knots or more.

NOTE—

V_{REF} in the above definition refers to the speed used in establishing the approved landing distance under the airworthiness regulations constituting the type certification basis of the airplane, regardless of whether that speed for a particular airplane is $1.3 V_{SO}$, $1.23 V_{SR}$, or some higher speed required for airplane controllability. This speed, at the maximum certificated landing weight, determines the lowest applicable approach category for all approaches regardless of actual landing weight.

b. When operating on an unpublished route or while being radar vectored, the pilot, when an

approach clearance is received, must, in addition to complying with the minimum altitudes for IFR operations (14 CFR Section 91.177), maintain the last assigned altitude unless a different altitude is assigned by ATC, or until the aircraft is established on a segment of a published route or IAP. After the aircraft is so established, published altitudes apply to descent within each succeeding route or approach segment unless a different altitude is assigned by ATC. Notwithstanding this pilot responsibility, for aircraft operating on unpublished routes or while being radar vectored, ATC will, except when conducting a radar approach, issue an IFR approach clearance only after the aircraft is established on a segment of a published route or IAP, or assign an altitude to maintain until the aircraft is established on a segment of a published route or instrument approach procedure. For this purpose, the procedure turn of a published IAP must not be considered a segment of that IAP until the aircraft reaches the initial fix or navigation facility upon which the procedure turn is predicated.

EXAMPLE—

Cross Redding VOR at or above five thousand, cleared VOR runway three four approach.

or

Five miles from outer marker, turn right heading three three zero, maintain two thousand until established on the localizer, cleared ILS runway three six approach.

NOTE—

1. *The altitude assigned will assure IFR obstruction clearance from the point at which the approach clearance is issued until established on a segment of a published route or IAP. If uncertain of the meaning of the clearance, immediately request clarification from ATC.*

2. *An aircraft is not established on an approach while below published approach altitudes. If the MVA/MIA allows, and ATC assigns an altitude below an IF or IAF altitude, the pilot will be issued an altitude to maintain until past a point that the aircraft is established on the approach.*

c. Several IAPs, using various navigation and approach aids may be authorized for an airport. ATC may advise that a particular approach procedure is being used, primarily to expedite traffic. If issued a clearance that specifies a particular approach procedure, notify ATC immediately if a different one is desired. In this event it may be necessary for ATC to withhold clearance for the different approach until such time as traffic conditions permit. However, a pilot involved in an emergency situation will be given priority. If the pilot is not familiar with the specific

approach procedure, ATC should be advised and they will provide detailed information on the execution of the procedure.

REFERENCE—

AIM, Paragraph 5-4-4, Advance Information on Instrument Approach

d. The name of an instrument approach, as published, is used to identify the approach, even though a component of the approach aid, such as the glideslope on an Instrument Landing System, is inoperative or unreliable. The controller will use the name of the approach as published, but must advise the aircraft at the time an approach clearance is issued that the inoperative or unreliable approach aid component is unusable, except when the title of the published approach procedures otherwise allows, for example, ILS or LOC.

e. Except when being radar vectored to the final approach course, when cleared for a specifically prescribed IAP; i.e., “cleared ILS runway one niner approach” or when “cleared approach” i.e., execution of any procedure prescribed for the airport, pilots must execute the entire procedure commencing at an IAF or an associated feeder route as described on the IAP chart unless an appropriate new or revised ATC clearance is received, or the IFR flight plan is canceled.

f. Pilots planning flights to locations which are private airfields or which have instrument approach procedures based on private navigation aids should obtain approval from the owner. In addition, the pilot must be authorized by the FAA to fly special instrument approach procedures associated with private navigation aids (see paragraph 5-4-8). Owners of navigation aids that are not for public use may elect to turn off the signal for whatever reason they may have; for example, maintenance, energy conservation, etc. Air traffic controllers are not required to question pilots to determine if they have permission to land at a private airfield or to use procedures based on privately owned navigation aids, and they may not know the status of the navigation aid. Controllers presume a pilot has obtained approval from the owner and the FAA for use of special instrument approach procedures and is aware of any details of the procedure if an IFR flight plan was filed to that airport.

g. Pilots should not rely on radar to identify a fix unless the fix is indicated as “RADAR” on the IAP. Pilots may request radar identification of an OM, but the controller may not be able to provide the service

due either to workload or not having the fix on the video map.

h. If a missed approach is required, advise ATC and include the reason (unless initiated by ATC). Comply with the missed approach instructions for the instrument approach procedure being executed, unless otherwise directed by ATC.

REFERENCE-

AIM, Paragraph 5-4-21, Missed Approach
AIM, Paragraph 5-5-5, Missed Approach,

5-4-8. Special Instrument Approach Procedures

Instrument Approach Procedure (IAP) charts reflect the criteria associated with the U.S. Standard for Terminal Instrument [Approach] Procedures (TERPs), which prescribes standardized methods for use in developing IAPs. Standard IAPs are published in the Federal Register (FR) in accordance with Title 14 of the Code of Federal Regulations, Part 97, and are available for use by appropriately qualified pilots operating properly equipped and airworthy aircraft in accordance with operating rules and procedures acceptable to the FAA. Special IAPs are also developed using TERPs but are not given public notice in the FR. The FAA authorizes only certain individual pilots and/or pilots in individual organizations to use special IAPs, and may require additional crew training and/or aircraft equipment or performance, and may also require the use of landing aids, communications, or weather services not available for public use. Additionally, IAPs that service private use airports or heliports are generally special IAPs. FDC NOTAMs for Specials, FDC T-NOTAMs, may also be used to promulgate safety-of-flight information relating to Specials provided the location has a valid landing area identifier and is serviced by the United States NOTAM system. Pilots may access NOTAMs online or through an FAA Flight Service Station (FSS). FSS specialists will not automatically provide NOTAM information to pilots for special IAPs during telephone pre-flight briefings. Pilots who are authorized by the FAA to use special IAPs must specifically request FDC NOTAM information for the particular special IAP they plan to use.

5-4-9. Procedure Turn and Hold-in-lieu of Procedure Turn

a. A procedure turn is the maneuver prescribed when it is necessary to reverse direction to establish the aircraft inbound on an intermediate or final approach course. The procedure turn or hold-in-lieu-of-PT is a required maneuver when it is depicted on the approach chart, unless cleared by ATC for a straight-in approach. Additionally, the procedure turn or hold-in-lieu-of-PT is not permitted when the symbol “No PT” is depicted on the initial segment being used, when a RADAR VECTOR to the final approach course is provided, or when conducting a timed approach from a holding fix. The altitude prescribed for the procedure turn is a minimum altitude until the aircraft is established on the inbound course. The maneuver must be completed within the distance specified in the profile view. For a hold-in-lieu-of-PT, the holding pattern direction must be flown as depicted and the specified leg length/timing must not be exceeded.

NOTE-

The pilot may elect to use the procedure turn or hold-in-lieu-of-PT when it is not required by the procedure, but must first receive an amended clearance from ATC. If the pilot is uncertain whether the ATC clearance intends for a procedure turn to be conducted or to allow for a straight-in approach, the pilot must immediately request clarification from ATC (14 CFR Section 91.123).

1. On U.S. Government charts, a barbed arrow indicates the maneuvering side of the outbound course on which the procedure turn is made. Headings are provided for course reversal using the 45 degree type procedure turn. However, the point at which the turn may be commenced and the type and rate of turn is left to the discretion of the pilot (limited by the charted remain within xx NM distance). Some of the options are the 45 degree procedure turn, the racetrack pattern, the teardrop procedure turn, or the 80 degree ↔ 260 degree course reversal. Racetrack entries should be conducted on the maneuvering side where the majority of protected airspace resides. If an entry places the pilot on the non-maneuvering side of the PT, correction to intercept the outbound course ensures remaining within protected airspace. Some procedure turns are specified by procedural track. These turns must be flown exactly as depicted.

2. Descent to the procedure turn (PT) completion altitude from the PT fix altitude (when one has

been published or assigned by ATC) must not begin until crossing over the PT fix or abeam and proceeding outbound. Some procedures contain a note in the chart profile view that says “Maintain (altitude) or above until established outbound for procedure turn” (See FIG 5-4-16). Newer procedures will simply depict an “at or above” altitude at the PT fix without a chart note (See FIG 5-4-17). Both are there to ensure required obstacle clearance is

provided in the procedure turn entry zone (See FIG 5-4-18). Absence of a chart note or specified minimum altitude adjacent to the PT fix is an indication that descent to the procedure turn altitude can commence immediately upon crossing over the PT fix, regardless of the direction of flight. This is because the minimum altitudes in the PT entry zone and the PT maneuvering zone are the same.

FIG 5-4-15
Example of an RNAV Approach with RF Leg

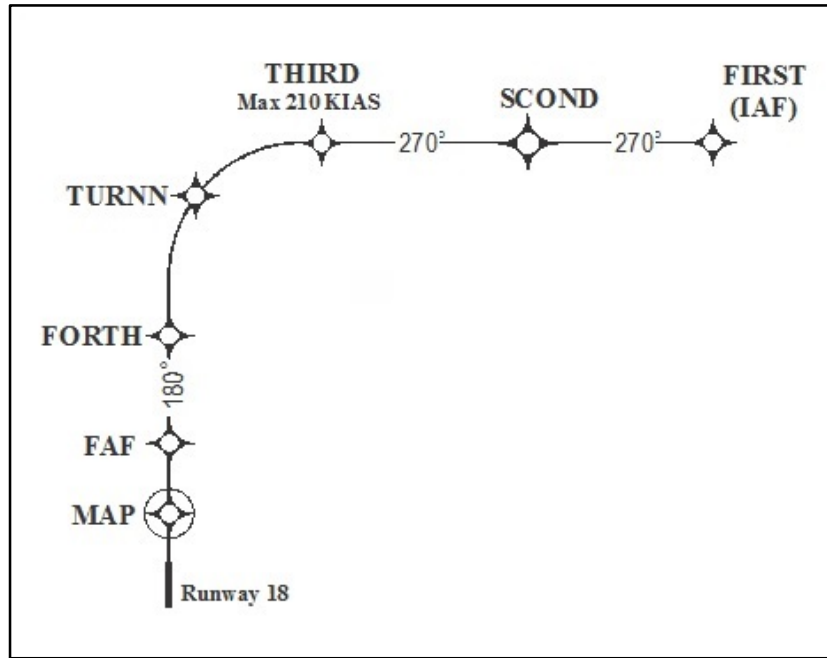

FIG 5-4-16

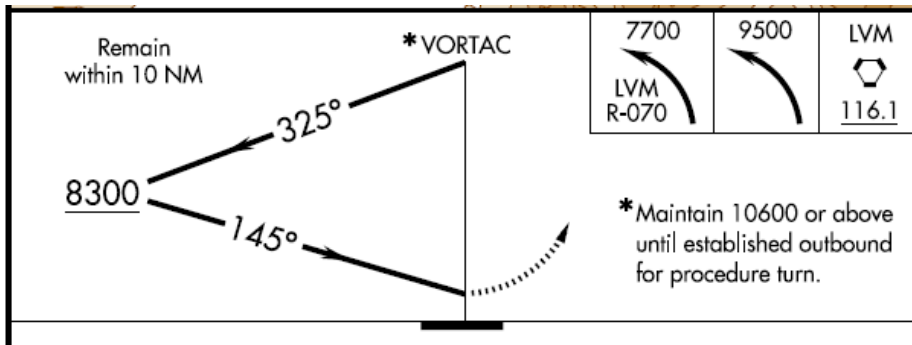

FIG 5-4-17

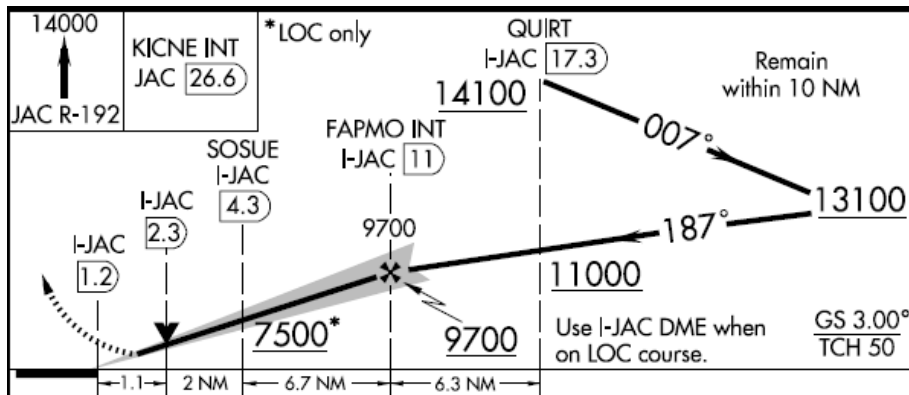
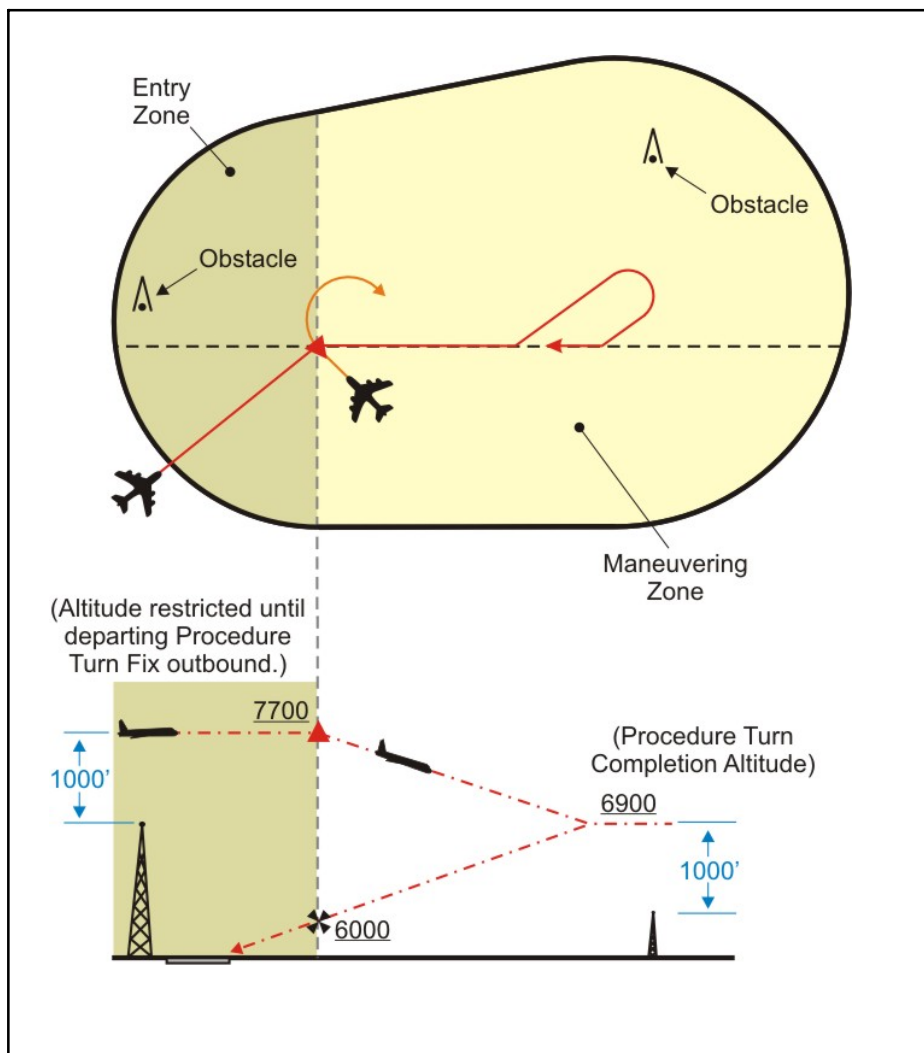

FIG 5-4-18



3. When the approach procedure involves a procedure turn, a maximum speed of not greater than 200 knots (IAS) should be observed from first overheading the course reversal IAF through the procedure turn maneuver to ensure containment within the obstruction clearance area. Pilots should begin the outbound turn immediately after passing the procedure turn fix. The procedure turn maneuver must be executed within the distance specified in the profile view. The normal procedure turn distance is 10 miles. This may be reduced to a minimum of 5 miles where only Category A or helicopter aircraft are to be operated or increased to as much as 15 miles to accommodate high performance aircraft.

4. A teardrop procedure or penetration turn may be specified in some procedures for a required course reversal. The teardrop procedure consists of departure from an initial approach fix on an outbound course followed by a turn toward and intercepting the inbound course at or prior to the intermediate fix or point. Its purpose is to permit an aircraft to reverse direction and lose considerable altitude within reasonably limited airspace. Where no fix is available to mark the beginning of the intermediate segment, it must be assumed to commence at a point 10 miles prior to the final approach fix. When the facility is located on the airport, an aircraft is considered to be on final approach upon completion of the penetration turn. However, the final approach segment begins on the final approach course 10 miles from the facility.

5. A holding pattern in lieu of procedure turn may be specified for course reversal in some procedures. In such cases, the holding pattern is established over an intermediate fix or a final approach fix. The holding pattern distance or time specified in the profile view must be observed. For a hold-in-lieu-of-PT, the holding pattern direction must be flown as depicted and the specified leg length/timing must not be exceeded. Maximum holding airspeed limitations as set forth for all holding patterns apply. The holding pattern maneuver is completed when the aircraft is established on the inbound course after executing the appropriate entry. If cleared for the approach prior to returning to the holding fix, and the aircraft is at the prescribed altitude, additional circuits of the holding pattern are not necessary nor expected by ATC. If pilots elect to make additional circuits to lose excessive altitude or to become better established on course, it is their

responsibility to so advise ATC upon receipt of their approach clearance.

NOTE—

Some approach charts have an arrival holding pattern depicted at the IAF using a “thin line” holding symbol. It is charted where holding is frequently required prior to starting the approach procedure so that detailed holding instructions are not required. The arrival holding pattern is not authorized unless assigned by Air Traffic Control. Holding at the same fix may also be depicted on the en route chart. A hold-in-lieu of procedure turn is depicted by a “thick line” symbol, and is part of the instrument approach procedure as described in paragraph 5–4–9. (See U. S. Terminal Procedures booklets page E1 for both examples.)

6. A procedure turn is not required when an approach can be made directly from a specified intermediate fix to the final approach fix. In such cases, the term “NoPT” is used with the appropriate course and altitude to denote that the procedure turn is not required. If a procedure turn is desired, and when cleared to do so by ATC, descent below the procedure turn altitude should not be made until the aircraft is established on the inbound course, since some NoPT altitudes may be lower than the procedure turn altitudes.

b. Limitations on Procedure Turns

1. In the case of a radar initial approach to a final approach fix or position, or a timed approach from a holding fix, or where the procedure specifies NoPT, no pilot may make a procedure turn unless, when final approach clearance is received, the pilot so advises ATC and a clearance is received to execute a procedure turn.

2. When a teardrop procedure turn is depicted and a course reversal is required, this type turn must be executed.

3. When a holding pattern replaces a procedure turn, the holding pattern must be followed, except when RADAR VECTORING is provided or when NoPT is shown on the approach course. The recommended entry procedures will ensure the aircraft remains within the holding pattern’s protected airspace. As in the procedure turn, the descent from the minimum holding pattern altitude to the final approach fix altitude (when lower) may not commence until the aircraft is established on the inbound course. Where a holding pattern is established in-lieu-of a procedure turn, the maximum holding pattern airspeeds apply.

REFERENCE-
AIM, Paragraph 5-3-8 j2, Holding

4. The absence of the procedure turn barb in the plan view indicates that a procedure turn is not authorized for that procedure.

5-4-10. Timed Approaches from a Holding Fix

a. **TIMED APPROACHES** may be conducted when the following conditions are met:

1. A control tower is in operation at the airport where the approaches are conducted.

2. Direct communications are maintained between the pilot and the center or approach controller until the pilot is instructed to contact the tower.

3. If more than one missed approach procedure is available, none require a course reversal.

4. If only one missed approach procedure is available, the following conditions are met:

(a) Course reversal is not required; and,

(b) Reported ceiling and visibility are equal to or greater than the highest prescribed circling minimums for the IAP.

5. When cleared for the approach, pilots must not execute a procedure turn. (14 CFR Section 91.175.)

b. Although the controller will not specifically state that “timed approaches are in use,” the assigning of a time to depart the final approach fix inbound (nonprecision approach) or the outer marker or fix used in lieu of the outer marker inbound (precision approach) is indicative that timed approach procedures are being utilized, or in lieu of holding, the controller may use radar vectors to the Final Approach Course to establish a mileage interval between aircraft that will ensure the appropriate time sequence between the final approach fix/outer marker or fix used in lieu of the outer marker and the airport.

c. Each pilot in an approach sequence will be given advance notice as to the time they should leave the holding point on approach to the airport. When a time to leave the holding point has been received, the pilot should adjust the flight path to leave the fix as closely as possible to the designated time. (See FIG 5-4-19.)

**FIG 5-4-19
Timed Approaches from a Holding Fix**

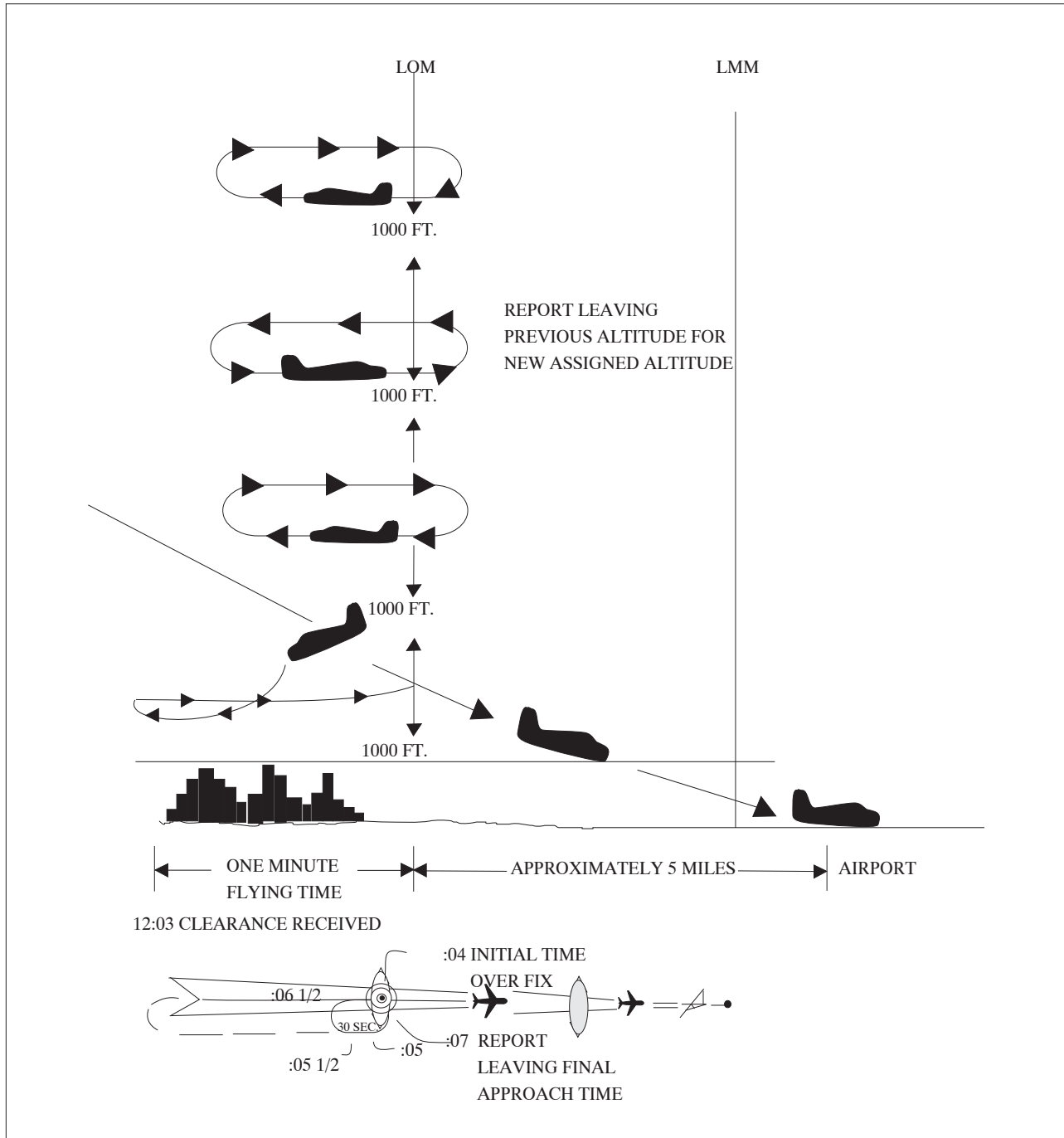

EXAMPLE-

At 12:03 local time, in the example shown, a pilot holding, receives instructions to leave the fix inbound at 12:07. These instructions are received just as the pilot has completed turn at the outbound end of the holding pattern and is proceeding inbound towards the fix. Arriving back over the fix, the pilot notes that the time is 12:04 and that there are 3 minutes to lose in order to leave the fix at the assigned time. Since the time remaining is more than two minutes, the pilot plans to fly a race track pattern rather than a 360 degree turn, which would use up 2 minutes. The turns at the ends of the race track pattern will consume approximately 2 minutes. Three minutes to go, minus 2 minutes required for the turns, leaves 1 minute for level flight. Since two portions of level flight will be required to get back to the fix inbound, the pilot halves the 1 minute remaining

and plans to fly level for 30 seconds outbound before starting the turn back to the fix on final approach. If the winds were negligible at flight altitude, this procedure would bring the pilot inbound across the fix precisely at the specified time of 12:07. However, if expecting headwind on final approach, the pilot should shorten the 30 second outbound course somewhat, knowing that the wind will carry the aircraft away from the fix faster while outbound and decrease the ground speed while returning to the fix. On the other hand, compensating for a tailwind on final approach, the pilot should lengthen the calculated 30 second outbound heading somewhat, knowing that the wind would tend to hold the aircraft closer to the fix while outbound and increase the ground speed while returning to the fix.

5-4-11. Radar Approaches

a. The only airborne radio equipment required for radar approaches is a functioning radio transmitter and receiver. The radar controller vectors the aircraft to align it with the runway centerline. The controller continues the vectors to keep the aircraft on course until the pilot can complete the approach and landing by visual reference to the surface. There are two types of radar approaches: Precision (PAR) and Surveillance (ASR).

b. A radar approach may be given to any aircraft upon request and may be offered to pilots of aircraft in distress or to expedite traffic, however, an ASR might not be approved unless there is an ATC operational requirement, or in an unusual or emergency situation. Acceptance of a PAR or ASR by a pilot does not waive the prescribed weather minimums for the airport or for the particular aircraft operator concerned. The decision to make a radar approach when the reported weather is below the established minimums rests with the pilot.

c. PAR and ASR minimums are published on separate pages in the FAA Terminal Procedures Publication (TPP).

1. Precision Approach (PAR). A PAR is one in which a controller provides highly accurate navigational guidance in azimuth and elevation to a pilot. Pilots are given headings to fly, to direct them to, and keep their aircraft aligned with the extended centerline of the landing runway. They are told to anticipate glidepath interception approximately 10 to 30 seconds before it occurs and when to start descent. The published Decision Height will be given only if the pilot requests it. If the aircraft is observed to deviate above or below the glidepath, the pilot is given the relative amount of deviation by use of terms “slightly” or “well” and is expected to adjust the aircraft’s rate of descent/ascent to return to the glidepath. Trend information is also issued with respect to the elevation of the aircraft and may be modified by the terms “rapidly” and “slowly”; e.g., “well above glidepath, coming down rapidly.”

Range from touchdown is given at least once each mile. If an aircraft is observed by the controller to proceed outside of specified safety zone limits in azimuth and/or elevation and continue to operate outside these prescribed limits, the pilot will be directed to execute a missed approach or to fly a specified course unless the pilot has the runway environment (runway, approach lights, etc.) in sight. Navigational guidance in azimuth and elevation is provided the pilot until the aircraft reaches the published Decision Height (DH). Advisory course and glidepath information is furnished by the controller until the aircraft passes over the landing threshold, at which point the pilot is advised of any deviation from the runway centerline. Radar service is automatically terminated upon completion of the approach.

2. Surveillance Approach (ASR). An ASR is one in which a controller provides navigational guidance in azimuth only. The pilot is furnished headings to fly to align the aircraft with the extended centerline of the landing runway. Since the radar information used for a surveillance approach is considerably less precise than that used for a precision approach, the accuracy of the approach will not be as great and higher minimums will apply. Guidance in elevation is not possible but the pilot will be advised when to commence descent to the Minimum Descent Altitude (MDA) or, if appropriate, to an intermediate step-down fix Minimum Crossing Altitude and subsequently to the prescribed MDA. In addition, the pilot will be advised of the location of the Missed Approach Point (MAP) prescribed for the procedure and the aircraft’s position each mile on final from the runway, airport or heliport or MAP, as appropriate. If requested by the pilot, recommended altitudes will be issued at each mile, based on the descent gradient established for the procedure, down to the last mile that is at or above the MDA. Normally, navigational guidance will be provided until the aircraft reaches the MAP. Controllers will terminate guidance and instruct the pilot to execute a missed approach unless at the MAP the pilot has the runway,

airport or heliport in sight or, for a helicopter point-in-space approach, the prescribed visual reference with the surface is established. Also, if, at any time during the approach the controller considers that safe guidance for the remainder of the approach cannot be provided, the controller will terminate guidance and instruct the pilot to execute a missed approach. Similarly, guidance termination and missed approach will be effected upon pilot request and, for civil aircraft only, controllers may terminate guidance when the pilot reports the runway, airport/heliport or visual surface route (point-in-space approach) in sight or otherwise indicates that continued guidance is not required. Radar service is automatically terminated at the completion of a radar approach.

NOTE-

1. *The published MDA for straight-in approaches will be issued to the pilot before beginning descent. When a surveillance approach will terminate in a circle-to-land maneuver, the pilot must furnish the aircraft approach category to the controller. The controller will then provide the pilot with the appropriate MDA.*

2. *ASR APPROACHES ARE NOT AVAILABLE WHEN AN ATC FACILITY IS USING CENRAP.*

3. NO-GYRO Approach. This approach is available to a pilot under radar control who experiences circumstances wherein the directional gyro or other stabilized compass is inoperative or inaccurate. When this occurs, the pilot should so advise ATC and request a No-Gyro vector or approach. Pilots of aircraft not equipped with a directional gyro or other stabilized compass who desire radar handling may also request a No-Gyro vector or approach. The pilot should make all turns at standard rate and should execute the turn immediately upon receipt of instructions. For example, “TURN RIGHT,” “STOP TURN.” When a surveillance or precision approach is made, the pilot will be advised after the aircraft has been turned onto final approach to make turns at half standard rate.

5-4-12. Radar Monitoring of Instrument Approaches

a. PAR facilities operated by the FAA and the military services at some joint-use (civil and

military) and military installations monitor aircraft on instrument approaches and issue radar advisories to the pilot when weather is below VFR minimums (1,000 and 3), at night, or when requested by a pilot. This service is provided only when the PAR Final Approach Course coincides with the final approach of the navigational aid and only during the operational hours of the PAR. The radar advisories serve only as a secondary aid since the pilot has selected the navigational aid as the primary aid for the approach.

b. Prior to starting final approach, the pilot will be advised of the frequency on which the advisories will be transmitted. If, for any reason, radar advisories cannot be furnished, the pilot will be so advised.

c. Advisory information, derived from radar observations, includes information on:

1. Passing the final approach fix inbound (nonprecision approach) or passing the outer marker or fix used in lieu of the outer marker inbound (precision approach).

NOTE-

At this point, the pilot may be requested to report sighting the approach lights or the runway.

2. Trend advisories with respect to elevation and/or azimuth radar position and movement will be provided.

NOTE-

Whenever the aircraft nears the PAR safety limit, the pilot will be advised that the aircraft is well above or below the glidepath or well left or right of course. Glidepath information is given only to those aircraft executing a precision approach, such as ILS. Altitude information is not transmitted to aircraft executing other than precision approaches because the descent portions of these approaches generally do not coincide with the depicted PAR glidepath.

3. If, after repeated advisories, the aircraft proceeds outside the PAR safety limit or if a radical deviation is observed, the pilot will be advised to execute a missed approach unless the prescribed visual reference with the surface is established.

d. Radar service is automatically terminated upon completion of the approach.

5-4-13. Simultaneous Approaches to Parallel Runways

FIG 5-4-20
Simultaneous Approaches
 (Approach Courses Parallel and Offset between 2.5 and 3.0 degrees)

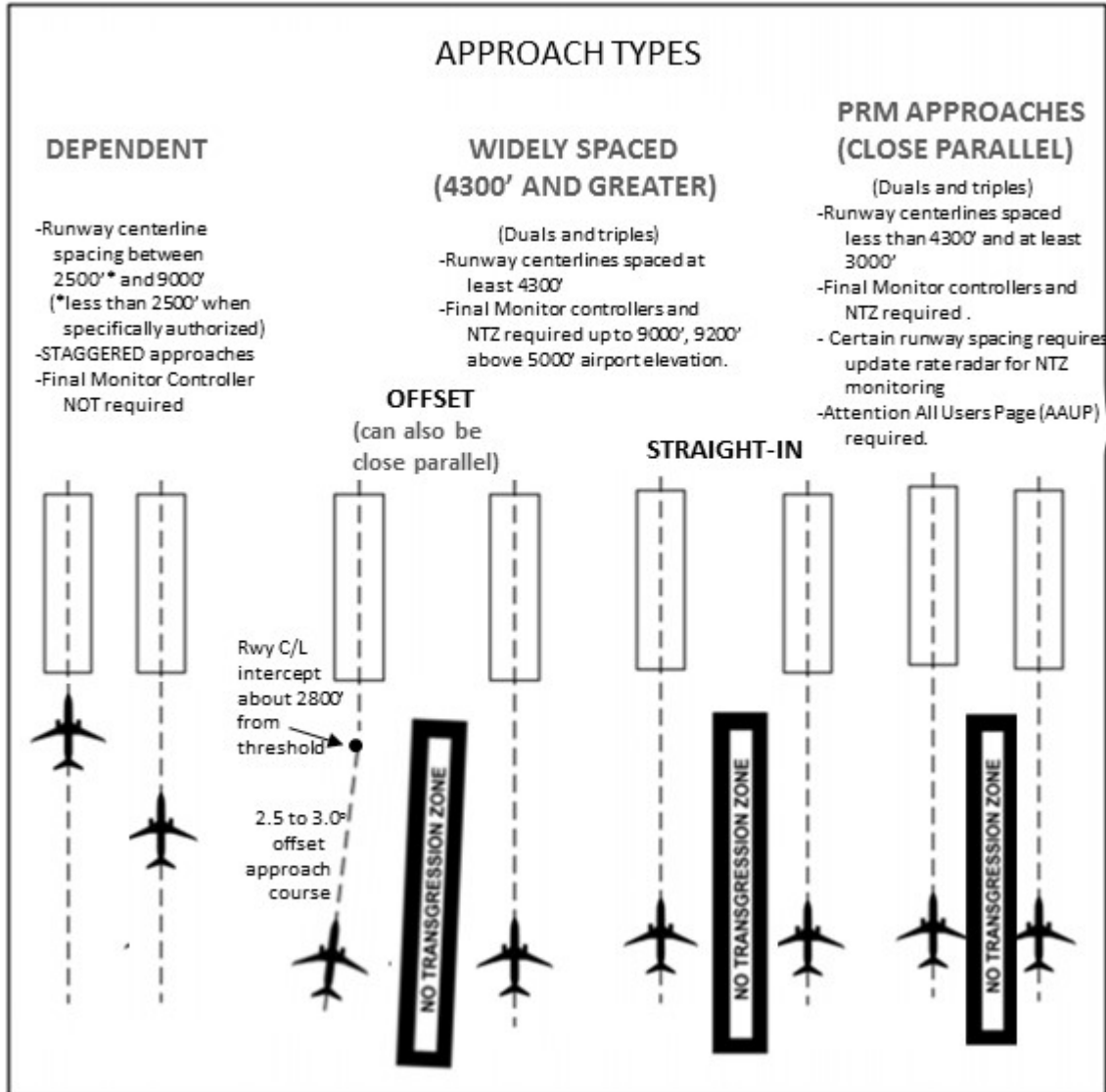

a. ATC procedures permit ILS/RNAV/GLS instrument approach operations to dual or triple parallel runway configurations. ILS/RNAV/GLS approaches to parallel runways are grouped into three classes: Simultaneous Dependent Approaches; Simultaneous Independent Approaches; and Simultaneous Close Parallel PRM Approaches. RNAV approach procedures that are approved for simultaneous operations require GPS as the sensor for position updating. VOR/DME, DME/DME and IRU RNAV updating is not authorized. The classification of a parallel runway approach procedure is dependent on adjacent parallel runway centerline separation, ATC procedures, and airport ATC final approach radar monitoring and communications capabilities. At some airports, one or more approach courses may be offset up to 3 degrees. ILS approaches with offset localizer configurations result in loss of Category II/III capabilities and an increase in decision altitude/height (50').

b. Depending on weather conditions, traffic volume, and the specific combination of runways being utilized for arrival operations, a runway may be used for different types of simultaneous operations, including closely spaced dependent or independent approaches. Pilots should ensure that they understand the type of operation that is being conducted, and ask ATC for clarification if necessary.

c. Parallel approach operations demand heightened pilot situational awareness. A thorough Approach Procedure Chart review should be conducted with, as a minimum, emphasis on the following approach chart information: name and number of the approach, localizer frequency, inbound localizer/azimuth course, glideslope/glidepath intercept altitude, glideslope crossing altitude at the final approach fix, decision height, missed approach instructions, special notes/procedures, and the assigned runway location/proximity to adjacent runways. Pilots are informed by ATC or through the ATIS that simultaneous approaches are in use.

d. The close proximity of adjacent aircraft conducting simultaneous independent approaches, especially simultaneous close parallel PRM ap-

proaches mandates strict pilot compliance with all ATC clearances. ATC assigned airspeeds, altitudes, and headings must be complied with in a timely manner. Autopilot coupled approaches require pilot knowledge of procedures necessary to comply with ATC instructions. Simultaneous independent approaches, particularly simultaneous close parallel PRM approaches necessitate precise approach course tracking to minimize final monitor controller intervention, and unwanted No Transgression Zone (NTZ) penetration. In the unlikely event of a breakout, ATC will not assign altitudes lower than the minimum vectoring altitude. Pilots should notify ATC immediately if there is a degradation of aircraft or navigation systems.

e. Strict radio discipline is mandatory during simultaneous independent and simultaneous close parallel PRM approach operations. This includes an alert listening watch and the avoidance of lengthy, unnecessary radio transmissions. Attention must be given to proper call sign usage to prevent the inadvertent execution of clearances intended for another aircraft. Use of abbreviated call signs must be avoided to preclude confusion of aircraft with similar sounding call signs. Pilots must be alert to unusually long periods of silence or any unusual background sounds in their radio receiver. A stuck microphone may block the issuance of ATC instructions on the tower frequency by the final monitor controller during simultaneous independent and simultaneous close parallel PRM approaches. In the case of PRM approaches, the use of a second frequency by the monitor controller mitigates the "stuck mike" or other blockage on the tower frequency.

REFERENCE—

AIM, Chapter 4, Section 2, Radio Communications Phraseology and Techniques, gives additional communications information.

f. Use of Traffic Collision Avoidance Systems (TCAS) provides an additional element of safety to parallel approach operations. Pilots should follow recommended TCAS operating procedures presented in approved flight manuals, original equipment manufacturer recommendations, professional newsletters, and FAA publications.

5-4-14. Simultaneous Dependent Approaches

FIG 5-4-21
Simultaneous Approaches
(Parallel Runways and Approach Courses)

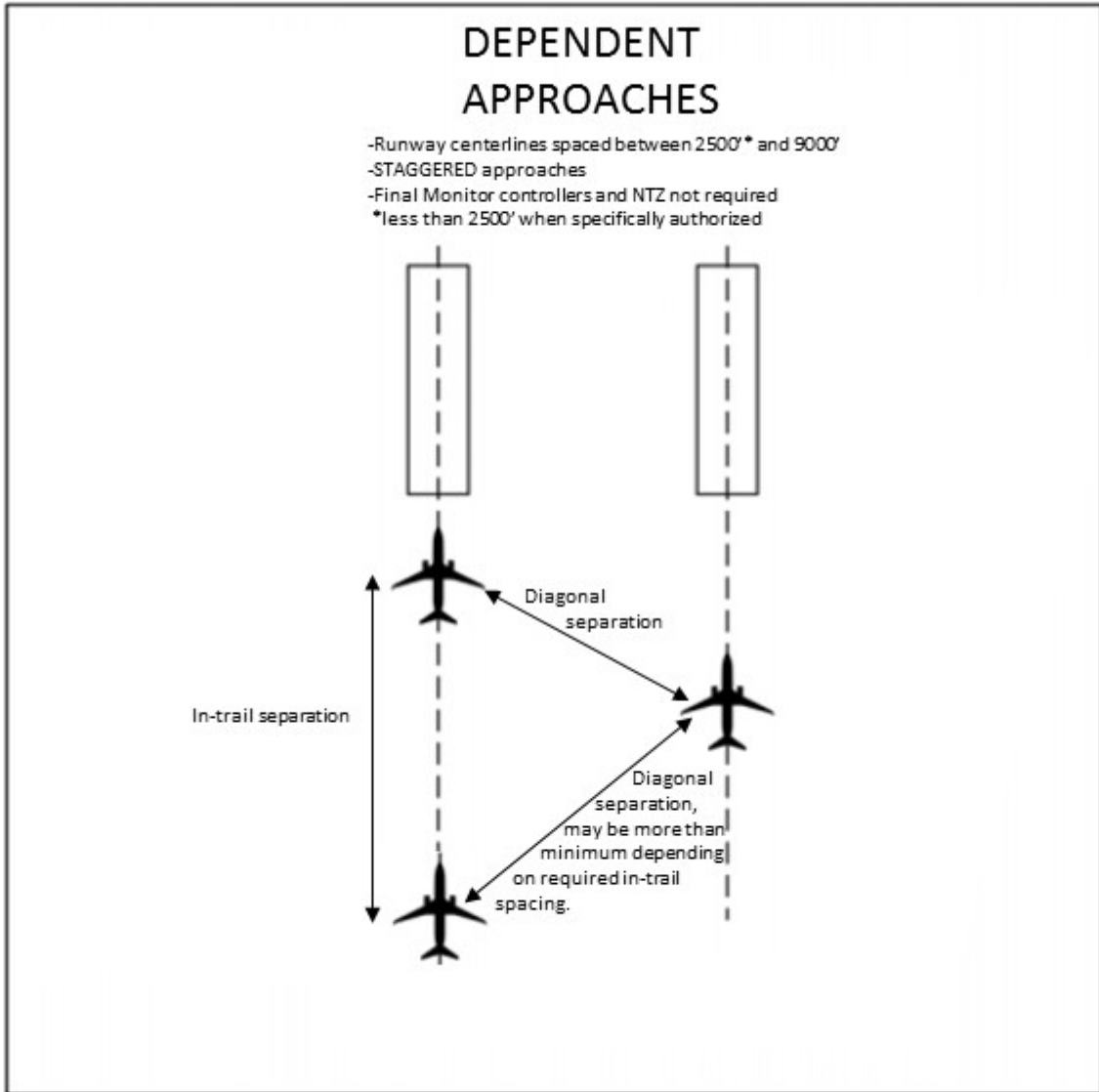

a. Simultaneous dependent approaches are an ATC procedure permitting approaches to airports having parallel runway centerlines separated by at least 2,500 feet up to 9,000 feet. Integral parts of a total system are ILS or other system providing approach navigation, radar, communications, ATC procedures, and required airborne equipment. RNAV equipment in the aircraft or GLS equipment on the ground and in the aircraft may replace the required airborne and ground based ILS equipment. Although non-precision minimums may be published, pilots must only use those procedures specifically authorized by chart note. For example, the chart note “LNAV NA during simultaneous operations,” requires vertical guidance. When given a choice, pilots should always fly a precision approach whenever possible.

b. A simultaneous dependent approach differs from a simultaneous independent approach in that, the minimum distance between parallel runway centerlines may be reduced; there is no requirement for radar monitoring or advisories; and a staggered separation of aircraft on the adjacent final course is required.

c. A minimum of 1.0 NM radar separation (diagonal) is required between successive aircraft on the adjacent final approach course when runway centerlines are at least 2,500 feet but no more than 3,600 feet apart. A minimum of 1.5 NM radar separation (diagonal) is required between successive aircraft on the adjacent final approach course when runway centerlines are more than 3,600 feet but no more than 8,300 feet apart. When runway centerlines are more than 8,300 feet but no more than 9,000 feet apart a minimum of 2 NM diagonal radar separation is provided. Aircraft on the same final approach course within 10 NM of the runway end are provided a minimum of 3 NM radar separation, reduced to 2.5 NM in certain circumstances. In addition, a minimum of 1,000 feet vertical or a minimum of three miles radar separation is provided between aircraft during turn on to the parallel final approach course.

d. Whenever parallel approaches are in use, pilots are informed by ATC or via the ATIS that approaches to both runways are in use. The charted IAP also notes

which runways may be used simultaneously. In addition, the radar controller will have the interphone capability of communicating with the tower controller where separation responsibility has not been delegated to the tower.

NOTE-

ATC will not specifically identify these operations as being dependent when advertised on the ATIS.

EXAMPLE-

Simultaneous ILS Runway 19 right and ILS Runway 19 left in use.

e. At certain airports, simultaneous dependent approaches are permitted to runways spaced less than 2,500 feet apart. In this case, ATC will provide no less than the minimum authorized diagonal separation with the leader always arriving on the same runway. The trailing aircraft is permitted reduced diagonal separation, instead of the single runway separation normally utilized for runways spaced less than 2,500 feet apart. For wake turbulence mitigation reasons:

1. Reduced diagonal spacing is only permitted when certain aircraft wake category pairings exist; typically when the leader is either in the large or small wake turbulence category, and

2. All aircraft must descend on the glideslope from the altitude at which they were cleared for the approach during these operations.

When reduced separation is authorized, the IAP briefing strip indicates that simultaneous operations require the use of vertical guidance and that the pilot should maintain last assigned altitude until intercepting the glideslope. No special pilot training is required to participate in these operations.

NOTE-

Either simultaneous dependent approaches with reduced separation or SOIA PRM approaches may be conducted to Runways 28R and 28L at KSFO spaced 750 feet apart, depending on weather conditions and traffic volume. Pilots should use caution so as not to confuse these operations. Plan for SOIA procedures only when ATC assigns a PRM approach or the ATIS advertises PRM approaches are in use. KSFO is the only airport where both procedures are presently conducted.

REFERENCE-

AIM, Paragraph 5-4-16, Simultaneous Close Parallel PRM Approaches and Simultaneous Offset Instrument Approaches (SOIA)

5-4-15. Simultaneous Independent ILS/RNAV/GLS Approaches

FIG 5-4-22
Simultaneous Independent ILS/RNAV/GLS Approaches

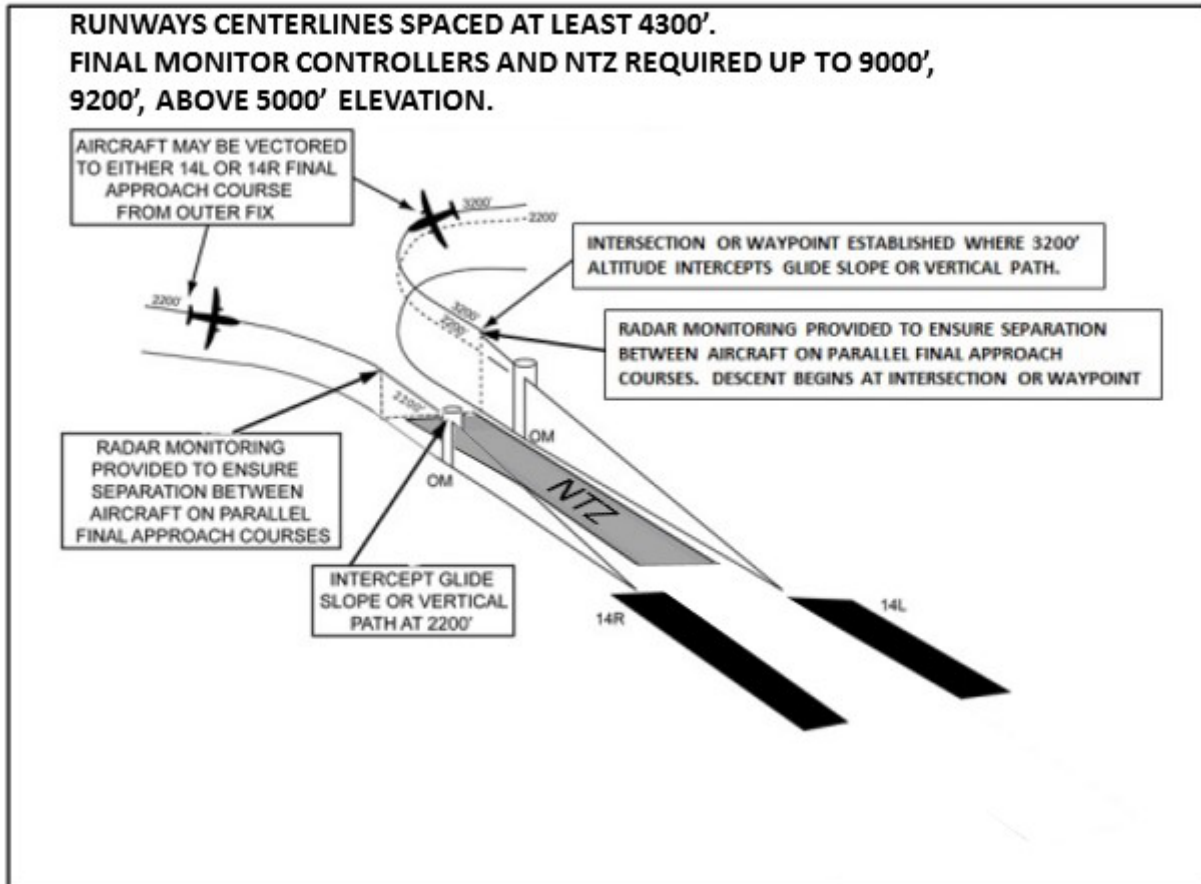

a. System. An approach system permitting simultaneous approaches to parallel runways with centerlines separated by at least 4,300 feet. Separation between 4,300 and 9,000 feet (9,200' for airports above 5,000') utilizing NTZ final monitor controllers. Simultaneous independent approaches require NTZ radar monitoring to ensure separation between aircraft on the adjacent parallel approach course. Aircraft position is tracked by final monitor controllers who will issue instructions to aircraft observed deviating from the assigned final approach course. Staggered radar separation procedures are not utilized. Integral parts of a total system are radar, communications, ATC procedures, and ILS or other required airborne equipment. A chart note identifies that the approach is authorized for simultaneous use.

When simultaneous operations are in use, it will be

advertised on the ATIS. When advised that simultaneous approaches are in use, pilots must advise approach control immediately of malfunctioning or inoperative receivers, or if a simultaneous approach is not desired. Although non-precision minimums may be published, pilots must only use those procedures specifically authorized by chart note. For example, the chart note "LNAV NA during simultaneous operations," requires vertical guidance. When given a choice, pilots should always fly a precision approach whenever possible.

NOTE-

ATC does not use the word *independent* or *parallel* when advertising these operations on the ATIS.

EXAMPLE-

Simultaneous ILS Runway 24 left and ILS Runway 24 right approaches in use.

b. Radar Services. These services are provided for each simultaneous independent approach.

1. During turn on to parallel final approach, aircraft are normally provided 3 miles radar separation or a minimum of 1,000 feet vertical separation. The assigned altitude must be maintained until intercepting the glidepath, unless cleared otherwise by ATC. Aircraft will not be vectored to intercept the final approach course at an angle greater than thirty degrees.

NOTE–

Some simultaneous operations permit the aircraft to track an RNAV course beginning on downwind and continuing in a turn to intercept the final approach course. In this case, separation with the aircraft on the adjacent final approach course is provided by the monitor controller with reference to an NTZ.

2. The final monitor controller will have the capability of overriding the tower controller on the tower frequency.

3. Pilots will be instructed to contact the tower frequency prior to the point where NTZ monitoring begins.

4. Aircraft observed to overshoot the turn–on or to continue on a track which will penetrate the NTZ will be instructed to return to the correct final approach course immediately. The final monitor controller may cancel the approach clearance, and issue missed approach or other instructions to the deviating aircraft.

PHRASEOLOGY–

“(Aircraft call sign) YOU HAVE CROSSED THE FINAL APPROACH COURSE. TURN (left/right) IMMEDIATELY AND RETURN TO THE FINAL APPROACH COURSE,”

or

“(aircraft call sign) TURN (left/right) AND RETURN TO THE FINAL APPROACH COURSE.”

5. If a deviating aircraft fails to respond to such instructions or is observed penetrating the NTZ, the aircraft on the adjacent final approach course (if threatened), will be issued a breakout instruction.

PHRASEOLOGY–

“TRAFFIC ALERT (aircraft call sign) TURN (left/right) IMMEDIATELY HEADING (degrees), (climb/descend) AND MAINTAIN (altitude).”

6. Radar monitoring will automatically be terminated when visual separation is applied, the aircraft reports the approach lights or runway in sight, or the aircraft is 1 NM or less from the runway threshold. Final monitor controllers will not advise pilots when radar monitoring is terminated.

NOTE–

Simultaneous independent approaches conducted to runways spaced greater than 9,000 feet (or 9,200’ at airports above 5,000’) do not require an NTZ. However, from a pilot’s perspective, the same alerts relative to deviating aircraft will be provided by ATC as are provided when an NTZ is being monitored. Pilots may not be aware as to whether or not an NTZ is being monitored.

5-4-16. Simultaneous Close Parallel PRM Approaches and Simultaneous Offset Instrument Approaches (SOIA)

FIG 5-4-23
PRM Approaches
Simultaneous Close Parallel

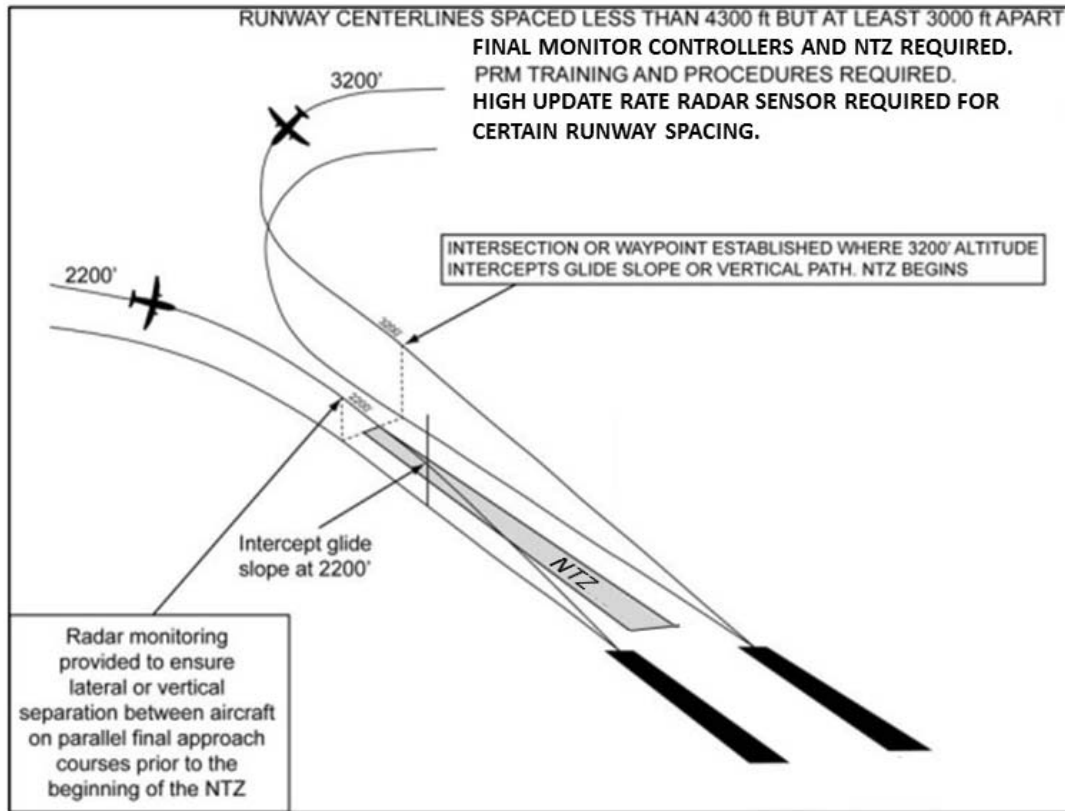

a. System.

1. PRM is an acronym for the high update rate Precision Runway Monitor surveillance system which is required to monitor the No Transgression Zone (NTZ) for specific parallel runway separations used to conduct simultaneous close parallel approaches. PRM is also published in the title as part of the approach name for IAPs used to conduct Simultaneous Close Parallel approaches. “PRM” alerts pilots that specific airborne equipment, training, and procedures are applicable.

Because Simultaneous Close Parallel PRM approaches are independent, the NTZ and normal operating zone (NOZ) airspace between the final approach courses is monitored by two monitor controllers, one for each approach course. The NTZ monitoring system (final monitor aid) consists of a high resolution ATC radar display with automated tracking software which provides monitor controllers with aircraft identification, position, speed, and a

ten-second projected position, as well as visual and aural NTZ penetration alerts. A PRM high update rate surveillance sensor is a component of this system only for specific runway spacing. Additional procedures for simultaneous independent approaches are described in Paragraph 5-4-15, Simultaneous Independent ILS/RNAV/GLS Approaches.

2. Simultaneous Close Parallel PRM approaches, whether conducted utilizing a high update rate PRM surveillance sensor or not, must meet all of the following requirements: pilot training, PRM in the approach title, NTZ monitoring utilizing a final monitor aid, radar display, publication of an AAUP, and use of a secondary PRM communications frequency. PRM approaches are depicted on a separate IAP titled (Procedure type) PRM Rwy XXX (Simultaneous Close Parallel or Close Parallel).

NOTE-

ATC does not use the word “independent” when advertising these operations on the ATIS.

EXAMPLE–

Simultaneous ILS PRM Runway 33 left and ILS PRM Runway 33 right approaches in use.

(a) The pilot may request to conduct a different type of PRM approach to the same runway other than the one that is presently being used; for example, RNAV instead of ILS. However, pilots must always obtain ATC approval to conduct a different type of approach. Also, in the event of the loss of ground-based NAVAIDS, the ATIS may advertise other types of PRM approaches to the affected runway or runways.

(b) The Attention All Users Page (AAUP) will address procedures for conducting PRM approaches.

b. Requirements and Procedures. Besides system requirements and pilot procedures as identified in subparagraph a1 above, all pilots must have completed special training before accepting a clearance to conduct a PRM approach.

1. Pilot Training Requirement. Pilots must complete special pilot training, as outlined below, before accepting a clearance for a simultaneous close parallel PRM approach.

(a) For operations under 14 CFR Parts 121, 129, and 135, pilots must comply with FAA-approved company training as identified in their Operations Specifications. Training includes the requirement for pilots to view the FAA training slide presentation, “Precision Runway Monitor (PRM) Pilot Procedures.” Refer to https://www.faa.gov/training_testing/training/prm/ or search key words “FAA PRM” for additional information and to view or download the slide presentation.

(b) For operations under Part 91:

(1) Pilots operating transport category aircraft must be familiar with PRM operations as contained in this section of the AIM. In addition, pilots operating transport category aircraft must view the slide presentation, “Precision Runway Monitor (PRM) Pilot Procedures.” Refer to https://www.faa.gov/training_testing/training/prm/ or search key words “FAA PRM” for additional information and to view or download the slide presentation.

(2) Pilots *not* operating transport category aircraft must be familiar with PRM and SOIA

operations as contained in this section of the AIM. The FAA strongly recommends that pilots *not* involved in transport category aircraft operations view the FAA training slide presentation, “Precision Runway Monitor (PRM) Pilot Procedures.” Refer to https://www.faa.gov/training_testing/training/prm/ or search key words “FAA PRM” for additional information and to view or download the slide presentation.

NOTE–

Depending on weather conditions, traffic volume, and the specific combination of runways being utilized for arrival operations, a runway may be used for different types of simultaneous operations, including closely spaced dependent or independent approaches. Use PRM procedures only when the ATIS advertises their use. For other types of simultaneous approaches, see paragraphs 5–4–14 and 5–4–15.

c. ATC Directed Breakout. An ATC directed “breakout” is defined as a vector off the final approach course of a threatened aircraft in response to another aircraft penetrating the NTZ.

d. Dual Communications. The aircraft flying the PRM approach must have the capability of enabling the pilot/s to listen to two communications frequencies simultaneously. To avoid blocked transmissions, each runway will have two frequencies, a primary and a PRM monitor frequency. The tower controller will transmit on both frequencies. The monitor controller’s transmissions, if needed, will override both frequencies. Pilots will **ONLY** transmit on the tower controller’s frequency, but will listen to both frequencies. Select the PRM monitor frequency audio only when instructed by ATC to contact the tower. The volume levels should be set about the same on both radios so that the pilots will be able to hear transmissions on the PRM frequency if the tower is blocked. Site-specific procedures take precedence over the general information presented in this paragraph. Refer to the AAUP for applicable procedures at specific airports.

e. Radar Services.

1. During turn on to parallel final approach, aircraft will be provided 3 miles radar separation or a minimum of 1,000 feet vertical separation. The assigned altitude must be maintained until intercepting the glideslope/glidepath, unless cleared otherwise by ATC. Aircraft will not be vectored to intercept the final approach course at an angle greater than thirty degrees.

2. The final monitor controller will have the capability of overriding the tower controller on the tower frequency as well as transmitting on the PRM frequency.

3. Pilots will be instructed to contact the tower frequency prior to the point where NTZ monitoring begins. Pilots will begin monitoring the secondary PRM frequency at that time (see Dual VHF Communications Required below).

4. To ensure separation is maintained, and in order to avoid an imminent situation during PRM approaches, pilots must immediately comply with PRM monitor controller instructions.

5. Aircraft observed to overshoot the turn or to continue on a track which will penetrate the NTZ will be instructed to return to the correct final approach course immediately. The final monitor controller may cancel the approach clearance, and issue missed approach or other instructions to the deviating aircraft.

PHRASEOLOGY–

“(Aircraft call sign) YOU HAVE CROSSED THE FINAL APPROACH COURSE. TURN (left/right) IMMEDIATELY AND RETURN TO THE FINAL APPROACH COURSE,”

or

“(Aircraft call sign) TURN (left/right) AND RETURN TO THE FINAL APPROACH COURSE.”

6. If a deviating aircraft fails to respond to such instructions or is observed penetrating the NTZ, the aircraft on the adjacent final approach course (if threatened) will be issued a breakout instruction.

PHRASEOLOGY–

“TRAFFIC ALERT (aircraft call sign) TURN (left/right) IMMEDIATELY HEADING (degrees), (climb/descend) AND MAINTAIN (altitude).”

7. Radar monitoring will automatically be terminated when visual separation is applied, or the

aircraft reports the approach lights or runway in sight or within 1 NM of the runway threshold. Final monitor controllers will not advise pilots when radar monitoring is terminated.

f. Attention All Users Page (AAUP). At airports that conduct PRM operations, the AAUP informs pilots under the “General” section of information relative to all the PRM approaches published at a specific airport, and this section must be briefed in its entirety. Under the “Runway Specific” section, only items relative to the runway to be used for landing need be briefed. (See FIG 5–4–24.) A single AAUP is utilized for multiple PRM approach charts at the same airport, which are listed on the AAUP. The requirement for informing ATC if the pilot is unable to accept a PRM clearance is also presented. The “General” section of AAUP addresses the following:

1. Review of the procedure for executing a climbing or descending breakout;

2. Breakout phraseology beginning with the words, “Traffic Alert;”

3. Descending on the glideslope/glidepath meets all crossing restrictions;

4. Briefing the PRM approach also satisfies the non-PRM approach briefing of the same type of approach to the same runway; and

5. Description of the dual communications procedure.

The “Runway Specific” section of the AAUP addresses those issues which only apply to certain runway ends that utilize PRM approaches. There may be no Runway Specific procedures, a single item applicable to only one runway end, or multiple items for a single or multiple runway end/s. Examples of SOIA runway specific procedures are as follows:

FIG 5-4-24
PRM Attention All Users Page (AAUP)

15288 PRM APPROACH AAUP	AL 166 (FAA)	USA INTL (USA) USA CITY
----------------------------	--------------	----------------------------

ATTENTION ALL USERS PAGE (AAUP)
 (PRM CLOSE PARALLEL)

Pilots who are unable to participate will be afforded appropriate arrival services as operational conditions permit and must notify the controlling ATC facility as soon as practical, but at least 120 miles from destination.

ILS PRM or LOC PRM RwyS 10R, 10C, 28L, 28C
 RNAV (GPS) PRM RWYS 10R, 10C, 28L, 28C

General

- Review procedure for executing a climbing and descending PRM breakout.
- Breakout phraseology: "TRAFFIC ALERT (call sign) TURN (left/right) IMMEDIATELY HEADING (degrees) CLIMB/DESCEND AND MAINTAIN (altitude)."
- All breakouts: Hand flown, initiate immediately.
- Descending on the glideslope/glidepath ensures compliance with any charted crossing restrictions.
- Dual VHF COMM: When assigned or planning a specific PRM approach, tune a second receiver to the PRM monitor frequency or, if silent, other active frequency (i.e., ATIS), set the volume, retune the PRM frequency if necessary, then deselect the audio. When directed by ATC, immediately switch to the tower frequency and select the secondary radio audio to ON.
- If later assigned the same runway, non-PRM approach, consider it briefed provided the same minimums are utilized. PRM related chart notes and frequency no longer apply.
- TCAS during breakout: Follow TCAS climb/descend if it differs from ATC, while executing the breakout turn.

Runway Specific

- Runway 10R: Exit at taxiway Tango whenever practical.

PRM APPROACH AAUP	41°59'N-87°54'W	USA INTL (USA) USA CITY
-------------------	-----------------	----------------------------

g. Simultaneous Offset Instrument Approach (SOIA).

1. SOIA is a procedure used to conduct simultaneous approaches to runways spaced less than 3,000 feet, but at least 750 feet apart. The SOIA procedure utilizes a straight-in PRM approach to one runway, and a PRM offset approach with glides-

lope/glidepath to the adjacent runway. In SOIA operations, aircraft are paired, with the aircraft conducting the straight-in PRM approach always positioned slightly ahead of the aircraft conducting the offset PRM approach.

2. The straight-in PRM approach plates used in SOIA operations are identical to other straight-in

PRM approach plates, with an additional note, which provides the separation between the two runways used for simultaneous SOIA approaches. The offset PRM approach plate displays the required notations for closely spaced approaches as well as depicts the visual segment of the approach.

3. Controllers monitor the SOIA PRM approaches in exactly the same manner as is done for other PRM approaches. The procedures and system requirements for SOIA PRM approaches are identical with those used for simultaneous close parallel PRM approaches until near the offset PRM approach missed approach point (MAP), where visual acquisition of the straight-in aircraft by the aircraft conducting the offset PRM approach occurs. Since SOIA PRM approaches are identical to other PRM approaches (except for the visual segment in the offset approach), an understanding of the procedures for conducting PRM approaches is essential before conducting a SOIA PRM operation.

4. In SOIA, the approach course separation (instead of the runway separation) meets established close parallel approach criteria. (See FIG 5-4-25 for the generic SOIA approach geometry.) A visual segment of the offset PRM approach is established between the offset MAP and the runway threshold. Aircraft transition in visual conditions from the offset course, beginning at the offset MAP, to align with the runway and can be stabilized by 500 feet above ground level (AGL) on the extended runway centerline. A cloud ceiling for the approach is established so that the aircraft conducting the offset approach has nominally at least 30 seconds or more to acquire the leading straight-in aircraft prior to reaching the offset MAP. If visual acquisition is not accomplished prior to crossing the offset MAP, a missed approach must be executed.

5. Flight Management System (FMS) coding of the offset RNAV PRM and GLS PRM approaches in a SOIA operation is different than other RNAV and GLS approach coding in that it does not match the initial missed approach procedure published on the charted IAP. In the SOIA design of the offset approach, lateral course guidance terminates at the

fictitious threshold point (FTP), which is an extension of the final approach course beyond the offset MAP to a point near the runway threshold. The FTP is designated in the approach coding as the MAP so that vertical guidance is available to the pilot to the runway threshold, just as vertical guidance is provided by the offset LDA glideslope. No matter what type of offset approach is being conducted, reliance on lateral guidance is discontinued at the charted MAP and replaced by visual maneuvering to accomplish runway alignment.

(a) As a result of this approach coding, when executing a missed approach at and after passing the charted offset MAP, a heading must initially be flown (either hand-flown or using autopilot “heading mode”) before engaging LNAV. If the pilot engages LNAV immediately, the aircraft may continue to track toward the FTP instead of commencing a turn toward the missed approach holding fix. Notes on the charted IAP and in the AAUP make specific reference to this procedure.

(b) Some FMSs do not code waypoints inside of the FAF as part of the approach. Therefore, the depicted MAP on the charted IAP may not be included in the offset approach coding. Pilots utilizing those FMSs may identify the location of the waypoint by noting its distance from the FTP as published on the charted IAP. In those same FMSs, the straight-in SOIA approach will not display a waypoint inside the PFAF. The same procedures may be utilized to identify an uncoded waypoint. In this case, the location is determined by noting its distance from the runway waypoint or using an authorized distance as published on the charted IAP.

(c) Because the FTP is coded as the MAP, the FMS map display will depict the initial missed approach course as beginning at the FTP. This depiction does not match the charted initial missed approach procedure on the IAP. Pilots are reminded that charted IAP guidance is to be followed, not the map display. Once the aircraft completes the initial turn when commencing a missed approach, the remainder of the procedure coding is standard and can be utilized as with any other IAP.

FIG 5-4-25
SOIA Approach Geometry

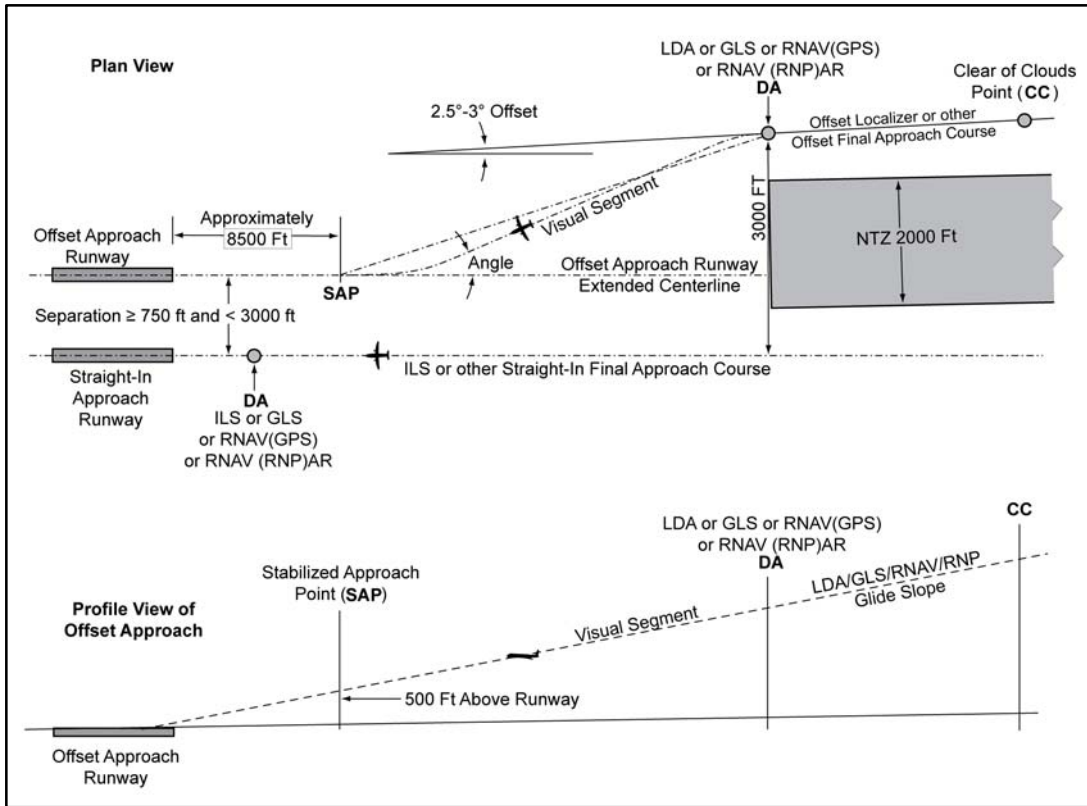

NOTE –

SAP The stabilized approach point is a design point along the extended centerline of the intended landing runway on the glide slope/glide path at 500 feet above the runway threshold elevation. It is used to verify a sufficient distance is provided for the visual maneuver after the offset course approach DA to permit the pilots to conform to approved, stabilized approach criteria. The SAP is not published on the IAP.

Offset Course DA The point along the LDA, or other offset course, where the course separation with the adjacent ILS, or other straight-in course, reaches the minimum distance permitted to conduct closely spaced approaches. Typically that minimum distance will be 3,000 feet without the use of high update radar; with high update radar, course separation of less than 3,000 ft may be used when validated by a safety study. The altitude of the glide slope/glide path at that point determines the offset course approach decision altitude and is where the NTZ terminates. Maneuvering inside the DA is done in visual conditions.

Visual Segment Angle Angle, as determined by the SOIA design tool, formed by the extension of the straight segment of the calculated flight track (between the offset course MAP/DA and the SAP) and the extended runway centerline. The size of the angle is dependent on the aircraft approach categories (Category D or only selected categories/speeds) that are authorized to use the offset course approach and the spacing between the runways.

Visibility Distance from the offset course approach DA to runway threshold in statute mile.

Procedure *The aircraft on the offset course approach must see the runway-landing environment and, if ATC has advised that traffic on the straight-in approach is a factor, the offset course approach aircraft must visually acquire the straight-in approach aircraft and report it in sight to ATC prior to reaching the DA for the offset course approach.*

CC *The Clear of Clouds point is the position on the offset final approach course where aircraft first operate in visual meteorological conditions below the ceiling, when the actual weather conditions are at, or near, the minimum ceiling for SOIA operations. Ceiling is defined by the Aeronautical Information Manual.*

6. SOIA PRM approaches utilize the same dual communications procedures as do other PRM approaches.

NOTE-

At KSFO, pilots conducting SOIA operations select the monitor frequency audio when communicating with the final radar controller, not the tower controller as is customary. In this special case, the monitor controller's transmissions, if required, override the final controller's frequency. This procedure is addressed on the AAUP.

(a) SOIA utilizes the same AAUP format as do other PRM approaches. The minimum weather conditions that are required are listed. Because of the more complex nature of instructions for conducting SOIA approaches, the "Runway Specific" items are more numerous and lengthy.

(b) Examples of SOIA offset runway specific notes:

(1) Aircraft must remain on the offset course until passing the offset MAP prior to maneuvering to align with the centerline of the offset approach runway.

(2) Pilots are authorized to continue past the offset MAP to align with runway centerline when:

[a] the straight-in approach traffic is in sight and is expected to remain in sight,

[b] ATC has been advised that "traffic is in sight." (ATC is not required to acknowledge this transmission),

[c] the runway environment is in sight. Otherwise, a missed approach must be executed. Between the offset MAP and the runway threshold, pilots conducting the offset PRM approach must not pass the straight-in aircraft and are responsible for separating themselves visually from traffic conducting the straight-in PRM approach to the adjacent runway, which means maneuvering the aircraft as necessary to avoid that traffic until landing, and

providing wake turbulence avoidance, if applicable. Pilots maintaining visual separation should advise ATC, as soon as practical, if visual contact with the aircraft conducting the straight-in PRM approach is lost and execute a missed approach unless otherwise instructed by ATC.

(c) Examples of SOIA straight-in runway specific notes:

(1) To facilitate the offset aircraft in providing wake mitigation, pilots should descend on, not above, the glideslope/glidepath.

(2) Conducting the straight-in approach, pilots should be aware that the aircraft conducting the offset approach will be approaching from the right/left rear and will be operating in close proximity to the straight-in aircraft.

7. Recap.

The following are differences between widely spaced simultaneous approaches (at least 4,300 feet between the runway centerlines) and Simultaneous PRM close parallel approaches which are of importance to the pilot:

(a) **Runway Spacing.** Prior to PRM simultaneous close parallel approaches, most ATC-directed breakouts were the result of two aircraft in-trail on the same final approach course getting too close together. Two aircraft going in the same direction did not mandate quick reaction times. With PRM closely spaced approaches, two aircraft could be alongside each other, navigating on courses that are separated by less than 4,300 feet and as close as 3,000 feet. In the unlikely event that an aircraft "blunders" off its course and makes a worst case turn of 30 degrees toward the adjacent final approach course, closing speeds of 135 feet per second could occur that constitute the need for quick reaction. A blunder has to be recognized by the monitor controller, and breakout instructions issued to the endangered aircraft. The pilot will not have any warning that a

breakout is imminent because the blundering aircraft will be on another frequency. It is important that, when a pilot receives breakout instructions, the assumption is made that a blundering aircraft is about to (or has penetrated the NTZ) and is heading toward his/her approach course. The pilot must initiate a breakout as soon as safety allows. While conducting PRM approaches, pilots must maintain an increased sense of awareness in order to immediately react to an ATC (breakout) instruction and maneuver (as instructed by ATC) away from a blundering aircraft.

(b) Communications. Dual VHF communications procedures should be carefully followed. One of the assumptions made that permits the safe conduct of PRM approaches is that there will be no blocked communications.

(c) Hand-flown Breakouts. The use of the autopilot is encouraged while flying a PRM approach, but the autopilot must be disengaged in the rare event that a breakout is issued. Simulation studies of breakouts have shown that a hand-flown breakout can be initiated consistently faster than a breakout performed using the autopilot.

(d) TCAS. The ATC breakout instruction is the primary means of conflict resolution. TCAS, if installed, provides another form of conflict resolution in the unlikely event other separation standards would fail. TCAS is not required to conduct a closely spaced approach.

The TCAS provides only vertical resolution of aircraft conflicts, while the ATC breakout instruction provides both vertical and horizontal guidance for conflict resolutions. Pilots should always immediately follow the TCAS Resolution Advisory (RA), whenever it is received. Should a TCAS RA be received before, during, or after an ATC breakout instruction is issued, the pilot should follow the RA, even if it conflicts with the climb/descent portion of the breakout maneuver. If following an RA requires deviating from an ATC clearance, the pilot must advise ATC as soon as practical. While following an RA, it is extremely important that the pilot also comply with the turn portion of the ATC breakout instruction unless the pilot determines safety to be a factor. Adhering to these procedures assures the pilot that acceptable “breakout” separation margins will always be provided, even in the face of a normal procedural or system failure.

5-4-17. Simultaneous Converging Instrument Approaches

a. ATC may conduct instrument approaches simultaneously to converging runways; i.e., runways having an included angle from 15 to 100 degrees, at airports where a program has been specifically approved to do so.

b. The basic concept requires that dedicated, separate standard instrument approach procedures be developed for each converging runway included. These approaches can be identified by the letter “V” in the title; for example, “ILS V Rwy 17 (CONVERGING)”. Missed Approach Points must be at least 3 miles apart and missed approach procedures ensure that missed approach protected airspace does not overlap.

c. Other requirements are: radar availability, nonintersecting final approach courses, precision approach capability for each runway and, if runways intersect, controllers must be able to apply visual separation as well as intersecting runway separation criteria. Intersecting runways also require minimums of at least 700 foot ceilings and 2 miles visibility. Straight in approaches and landings must be made.

d. Whenever simultaneous converging approaches are in use, aircraft will be informed by the controller as soon as feasible after initial contact or via ATIS. Additionally, the radar controller will have direct communications capability with the tower controller where separation responsibility has not been delegated to the tower.

5-4-18. RNP AR Instrument Approach Procedures

These procedures require authorization analogous to the special authorization required for Category II or III ILS procedures. Authorization required (AR) procedures are to be conducted by aircrews meeting special training requirements in aircraft that meet the specified performance and functional requirements.

a. Unique characteristics of RNP AR Approaches

1. RNP value. Each published line of minima has an associated RNP value. The indicated value defines the lateral and vertical performance requirements. A minimum RNP type is documented as part of the RNP AR authorization for each operator and may vary depending on aircraft configuration or

operational procedures (e.g., GPS inoperative, use of flight director vice autopilot).

2. Curved path procedures. Some RNP approaches have a curved path, also called a radius-to-a-fix (RF) leg. Since not all aircraft have the capability to fly these arcs, pilots are responsible for knowing if they can conduct an RNP approach with an arc or not. Aircraft speeds, winds and bank angles have been taken into consideration in the development of the procedures.

3. RNP required for extraction or not. Where required, the missed approach procedure may use RNP values less than RNP-1. The reliability of the navigation system has to be very high in order to conduct these approaches. Operation on these procedures generally requires redundant equipment, as no single point of failure can cause loss of both approach and missed approach navigation.

4. Non-standard speeds or climb gradients. RNP AR approaches are developed based on standard approach speeds and a 200 ft/NM climb gradient in the missed approach. Any exceptions to these standards will be indicated on the approach procedure, and the operator should ensure they can comply with any published restrictions before conducting the operation.

5. Temperature Limits. For aircraft using barometric vertical navigation (without temperature compensation) to conduct the approach, low and high-temperature limits are identified on the procedure. Cold temperatures reduce the glidepath angle while high temperatures increase the glidepath angle. Aircraft using baro VNAV with temperature compensation or aircraft using an alternate means for vertical guidance (e.g., SBAS) may disregard the temperature restrictions. The charted temperature limits are evaluated for the final approach segment only. Regardless of charted temperature limits or temperature compensation by the FMS, the pilot may need to manually compensate for cold temperature on minimum altitudes and the decision altitude.

6. Aircraft size. The achieved minimums may be dependent on aircraft size. Large aircraft may require higher minimums due to gear height and/or wingspan. Approach procedure charts will be annotated with applicable aircraft size restrictions.

b. Types of RNP AR Approach Operations

1. RNP Stand-alone Approach Operations. RNP AR procedures can provide access to runways regardless of the ground-based NAVAID infrastructure, and can be designed to avoid obstacles, terrain, airspace, or resolve environmental constraints.

2. RNP Parallel Approach (RPA) Operations. RNP AR procedures can be used for parallel approaches where the runway separation is adequate (See FIG 5-4-26). Parallel approach procedures can be used either simultaneously or as stand-alone operations. They may be part of either independent or dependent operations depending on the ATC ability to provide radar monitoring.

FIG 5-4-26

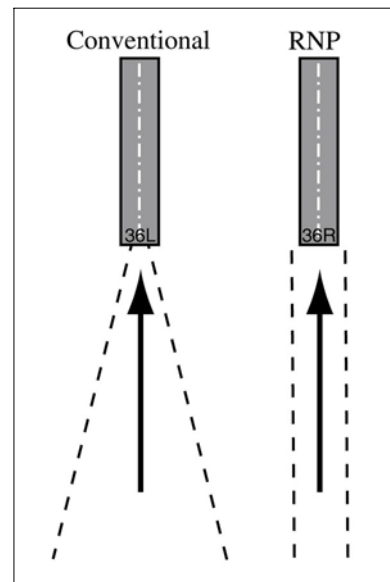

3. RNP Parallel Approach Runway Transitions (RPAT) Operations. RPAT approaches begin as a parallel IFR approach operation using simultaneous independent or dependent procedures. (See FIG 5-4-27). Visual separation standards are used in the final segment of the approach after the final approach fix, to permit the RPAT aircraft to transition in visual conditions along a predefined lateral and vertical path to align with the runway centerline.

FIG 5-4-27

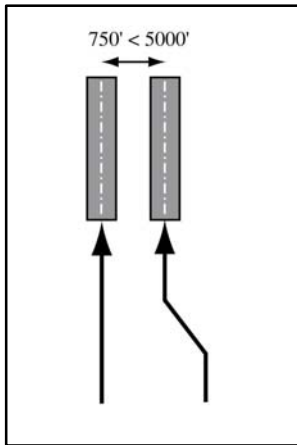

4. RNP Converging Runway Operations. At airports where runways converge, but may or may not intersect, an RNP AR approach can provide a precise curved missed approach path that conforms to aircraft separation minimums for simultaneous operations (See FIG 5-4-28). By flying this curved missed approach path with high accuracy and containment provided by RNP, dual runway operations may continue to be used to lower ceiling and visibility values than currently available. This type of operation allows greater capacity at airports where it can be applied.

FIG 5-4-28

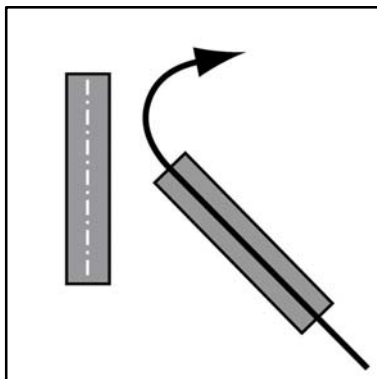

5-4-19. Side-step Maneuver

a. ATC may authorize a standard instrument approach procedure which serves either one of parallel runways that are separated by 1,200 feet or

less followed by a straight-in landing on the adjacent runway.

b. Aircraft that will execute a side-step maneuver will be cleared for a specified approach procedure and landing on the adjacent parallel runway. Example, “cleared ILS runway 7 left approach, side-step to runway 7 right.” Pilots are expected to commence the side-step maneuver as soon as possible after the runway or runway environment is in sight. Compliance with minimum altitudes associated with stepdown fixes is expected even after the side-step maneuver is initiated.

NOTE-

Side-step minima are flown to a Minimum Descent Altitude (MDA) regardless of the approach authorized.

c. Landing minimums to the adjacent runway will be based on nonprecision criteria and therefore higher than the precision minimums to the primary runway, but will normally be lower than the published circling minimums.

5-4-20. Approach and Landing Minimums

a. **Landing Minimums.** The rules applicable to landing minimums are contained in 14 CFR Section 91.175. TBL 5-4-1 may be used to convert RVR to ground or flight visibility. For converting RVR values that fall between listed values, use the next higher RVR value; do not interpolate. For example, when converting 1800 RVR, use 2400 RVR with the resultant visibility of 1/2 mile.

b. **Obstacle Clearance.** Final approach obstacle clearance is provided from the start of the final segment to the runway or missed approach point, whichever occurs last. Side-step obstacle protection is provided by increasing the width of the final approach obstacle clearance area.

TBL 5-4-1

RVR Value Conversions

RVR	Visibility (statute miles)
1600	1/4
2400	1/2
3200	5/8
4000	3/4
4500	7/8
5000	1
6000	1 1/4

1. Circling approach protected areas are defined by the tangential connection of arcs drawn from each runway end (see FIG 5-4-29). Circling approach protected areas developed prior to late 2012 used fixed radius distances, dependent on aircraft approach category, as shown in the table on page B2 of the U.S. TPP. The approaches using standard circling approach areas can be identified by the absence of the “negative C” symbol on the circling line of minima. Circling approach protected areas developed after late 2012 use the radius distance shown in the table on page B2 of the U.S. TPP, dependent on aircraft approach category, and the altitude of the circling MDA, which accounts for true airspeed increase with altitude. The approaches using expanded circling approach areas can be identified by the presence of the “negative C” symbol on the circling line of minima (see FIG 5-4-30). Because of obstacles near the airport, a portion of the circling

area may be restricted by a procedural note; for example, “Circling NA E of RWY 17-35.” Obstacle clearance is provided at the published minimums (MDA) for the pilot who makes a straight-in approach, side-steps, or circles. Once below the MDA the pilot must see and avoid obstacles. Executing the missed approach after starting to maneuver usually places the aircraft beyond the MAP. The aircraft is clear of obstacles when at or above the MDA while inside the circling area, but simply joining the missed approach ground track from the circling maneuver may not provide vertical obstacle clearance once the aircraft exits the circling area. Additional climb inside the circling area may be required before joining the missed approach track. See Paragraph 5-4-21, Missed Approach, for additional considerations when starting a missed approach at other than the MAP.

FIG 5-4-29
Final Approach Obstacle Clearance

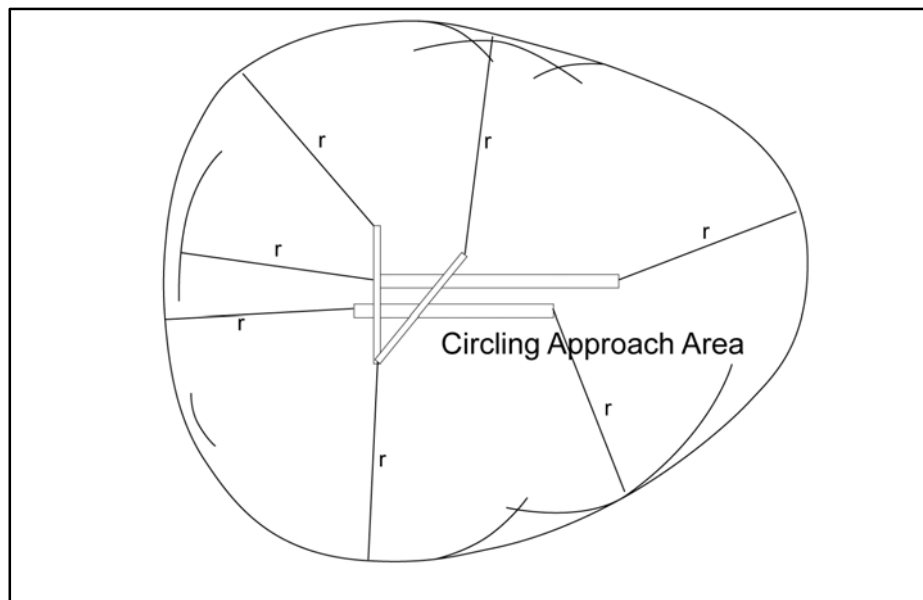

NOTE-

Circling approach area radii vary according to approach category and MSL circling altitude due to TAS changes – see FIG 5-4-30.

FIG 5-4-30

Standard and Expanded Circling Approach Radii in the U.S. TPP

STANDARD CIRCLING APPROACH MANEUVERING RADIUS

Circling approach protected areas developed prior to late 2012 used the radius distances shown in the following table, expressed in nautical miles (NM), dependent on aircraft approach category. The approaches using standard circling approach areas can be identified by the absence of the **C** symbol on the circling line of minima.

Circling MDA in feet MSL	Approach Category and Circling Radius (NM)				
	CAT A	CAT B	CAT C	CAT D	CAT E
All Altitudes	1.3	1.5	1.7	2.3	4.5

C EXPANDED CIRCLING APPROACH MANEUVERING AIRSPACE RADIUS

Circling approach protected areas developed after late 2012 use the radius distance shown in the following table, expressed in nautical miles (NM), dependent on aircraft approach category, and the altitude of the circling MDA, which accounts for true airspeed increase with altitude. The approaches using expanded circling approach areas can be identified by the presence of the **C** symbol on the circling line of minima.

Circling MDA in feet MSL	Approach Category and Circling Radius (NM)				
	CAT A	CAT B	CAT C	CAT D	CAT E
1000 or less	1.3	1.7	2.7	3.6	4.5
1001-3000	1.3	1.8	2.8	3.7	4.6
3001-5000	1.3	1.8	2.9	3.8	4.8
5001-7000	1.3	1.9	3.0	4.0	5.0
7001-9000	1.4	2.0	3.2	4.2	5.3
9001 and above	1.4	2.1	3.3	4.4	5.5

2. Precision Obstacle Free Zone (POFZ). A volume of airspace above an area beginning at the runway threshold, at the threshold elevation, and centered on the extended runway centerline. The POFZ is 200 feet (60m) long and 800 feet (240m) wide. The POFZ must be clear when an aircraft on a vertically guided final approach is within 2 nautical miles of the runway threshold and the official weather observation is a ceiling below 250 feet or visibility less than $\frac{3}{4}$ statute mile (SM) (or runway visual range below 4,000 feet). If the POFZ is not clear, the MINIMUM authorized height above touchdown (HAT) and visibility is 250 feet and $\frac{3}{4}$ SM. The POFZ is considered clear even if the wing of the aircraft holding on a taxiway waiting for runway clearance penetrates the POFZ; however, neither the fuselage nor the tail may infringe on the POFZ. The POFZ is applicable at all runway ends including displaced thresholds.

FIG 5-4-31

Precision Obstacle Free Zone (POFZ)

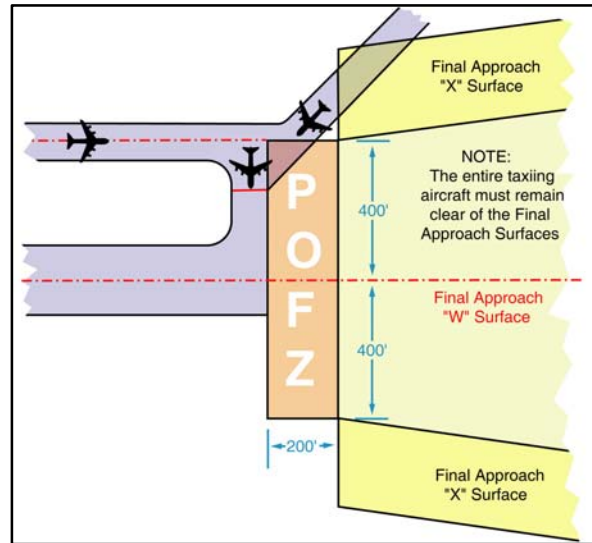

c. Straight-in Minimums are shown on the IAP when the final approach course is within 30 degrees of the runway alignment (15 degrees for GPS IAPs) and a normal descent can be made from the IFR altitude shown on the IAP to the runway surface. When either the normal rate of descent or the runway alignment factor of 30 degrees (15 degrees for GPS IAPs) is exceeded, a straight-in minimum is not published and a circling minimum applies. The fact that a straight-in minimum is not published does not preclude pilots from landing straight-in if they have the active runway in sight and have sufficient time to make a normal approach for landing. Under such conditions and when ATC has cleared them for landing on that runway, pilots are not expected to circle even though only circling minimums are published. If they desire to circle, they should advise ATC.

d. Side-Step Maneuver Minimums. Landing minimums for a side-step maneuver to the adjacent runway will normally be higher than the minimums to the primary runway.

e. Published Approach Minimums. Approach minimums are published for different aircraft categories and consist of a minimum altitude (DA, DH, MDA) and required visibility. These minimums are determined by applying the appropriate TERPS criteria. When a fix is incorporated in a nonprecision final segment, two sets of minimums may be published: one for the pilot that is able to identify the fix, and a second for the pilot that cannot. Two sets of minimums may also be published when a second altimeter source is used in the procedure. When a nonprecision procedure incorporates both a step-down fix in the final segment and a second altimeter source, two sets of minimums are published to account for the stepdown fix and a note addresses minimums for the second altimeter source.

f. Circling Minimums. In some busy terminal areas, ATC may not allow circling and circling minimums will not be published. Published circling minimums provide obstacle clearance when pilots remain within the appropriate area of protection. Pilots should remain at or above the circling altitude

until the aircraft is continuously in a position from which a descent to a landing on the intended runway can be made at a normal rate of descent using normal maneuvers. Circling may require maneuvers at low altitude, at low airspeed, and in marginal weather conditions. Pilots must use sound judgment, have an in-depth knowledge of their capabilities, and fully understand the aircraft performance to determine the exact circling maneuver since weather, unique airport design, and the aircraft position, altitude, and airspeed must all be considered. The following basic rules apply:

1. Maneuver the shortest path to the base or downwind leg, as appropriate, considering existing weather conditions. There is no restriction from passing over the airport or other runways.

2. It should be recognized that circling maneuvers may be made while VFR or other flying is in progress at the airport. Standard left turns or specific instruction from the controller for maneuvering must be considered when circling to land.

3. At airports without a control tower, it may be desirable to fly over the airport to observe wind and turn indicators and other traffic which may be on the runway or flying in the vicinity of the airport.

REFERENCE—

AC 90-66A, Recommended Standards Traffic patterns for Aeronautical Operations at Airports without Operating Control Towers.

4. The missed approach point (MAP) varies depending upon the approach flown. For vertically guided approaches, the MAP is at the decision altitude/decision height. Non-vertically guided and circling procedures share the same MAP and the pilot determines this MAP by timing from the final approach fix, by a fix, a NAVAID, or a waypoint. Circling from a GLS, an ILS without a localizer line of minima or an RNAV (GPS) approach without an LNAV line of minima is prohibited.

g. Instrument Approach at a Military Field. When instrument approaches are conducted by civil aircraft at military airports, they must be conducted in accordance with the procedures and minimums approved by the military agency having jurisdiction over the airport.

5-4-21. Missed Approach

a. When a landing cannot be accomplished, advise ATC and, upon reaching the missed approach point defined on the approach procedure chart, the pilot must comply with the missed approach instructions for the procedure being used or with an alternate missed approach procedure specified by ATC.

b. Obstacle protection for missed approach is predicated on the missed approach being initiated at the decision altitude/decision height (DA/DH) or at the missed approach point and not lower than minimum descent altitude (MDA). A climb gradient of at least 200 feet per nautical mile is required, (except for Copter approaches, where a climb of at least 400 feet per nautical mile is required), unless a higher climb gradient is published in the notes section of the approach procedure chart. When higher than standard climb gradients are specified, the end point of the non-standard climb will be specified at either an altitude or a fix. Pilots must preplan to ensure that the aircraft can meet the climb gradient (expressed in feet per nautical mile) required by the procedure in the event of a missed approach, and be aware that flying at a higher than anticipated ground speed increases the climb rate requirement (feet per minute). Tables for the conversion of climb gradients (feet per nautical mile) to climb rate (feet per minute), based on ground speed, are included on page D1 of the U.S. Terminal Procedures booklets. Reasonable buffers are provided for normal maneuvers. However, no consideration is given to an abnormally early turn. Therefore, when an early missed approach is executed, pilots should, unless otherwise cleared by ATC, fly the IAP as specified on the approach plate to the missed approach point at or above the MDA or DH before executing a turning maneuver.

c. If visual reference is lost while circling-to-land from an instrument approach, the missed approach specified for that particular procedure must be followed (unless an alternate missed approach procedure is specified by ATC). To become established on the prescribed missed approach course, the pilot should make an initial climbing turn toward the landing runway and continue the turn until established on the missed approach course. Inasmuch as the circling maneuver may be accomplished in more than one direction, different patterns will be required to become established on the prescribed missed approach course, depending on the aircraft

position at the time visual reference is lost. Adherence to the procedure will help assure that an aircraft will remain laterally within the circling and missed approach obstruction clearance areas. Refer to paragraph h concerning vertical obstruction clearance when starting a missed approach at other than the MAP. (See FIG 5-4-32.)

d. At locations where ATC radar service is provided, the pilot should conform to radar vectors when provided by ATC in lieu of the published missed approach procedure. (See FIG 5-4-33.)

e. Some locations may have a preplanned alternate missed approach procedure for use in the event the primary NAVAID used for the missed approach procedure is unavailable. To avoid confusion, the alternate missed approach instructions are not published on the chart. However, the alternate missed approach holding pattern will be depicted on the instrument approach chart for pilot situational awareness and to assist ATC by not having to issue detailed holding instructions. The alternate missed approach may be based on NAVAIDs not used in the approach procedure or the primary missed approach. When the alternate missed approach procedure is implemented by NOTAM, it becomes a mandatory part of the procedure. The NOTAM will specify both the textual instructions and any additional equipment requirements necessary to complete the procedure. Air traffic may also issue instructions for the alternate missed approach when necessary, such as when the primary missed approach NAVAID fails during the approach. Pilots may reject an ATC clearance for an alternate missed approach that requires equipment not necessary for the published approach procedure when the alternate missed approach is issued after beginning the approach. However, when the alternate missed approach is issued prior to beginning the approach the pilot must either accept the entire procedure (including the alternate missed approach), request a different approach procedure, or coordinate with ATC for alternative action to be taken, i.e., proceed to an alternate airport, etc.

f. When approach has been missed, request clearance for specific action; i.e., to alternative airport, another approach, etc.

g. Pilots must ensure that they have climbed to a safe altitude prior to proceeding off the published missed approach, especially in nonradar environments. Abandoning the missed approach prior to reaching the published altitude may not provide

adequate terrain clearance. Additional climb may be required after reaching the holding pattern before proceeding back to the IAF or to an alternate.

h. A clearance for an instrument approach procedure includes a clearance to fly the published missed approach procedure, unless otherwise instructed by ATC. The published missed approach procedure provides obstacle clearance only when the missed approach is conducted on the missed approach segment from or above the missed approach point, and assumes a climb rate of 200 feet/NM or higher, as published. If the aircraft initiates a missed approach at a point other than the missed approach point (see paragraph 5-4-5b), from below MDA or DA (H), or on a circling approach, obstacle clearance is not necessarily provided by following the published missed approach procedure, nor is separation assured from other air traffic in the vicinity.

FIG 5-4-32

Circling and Missed Approach Obstruction Clearance Areas

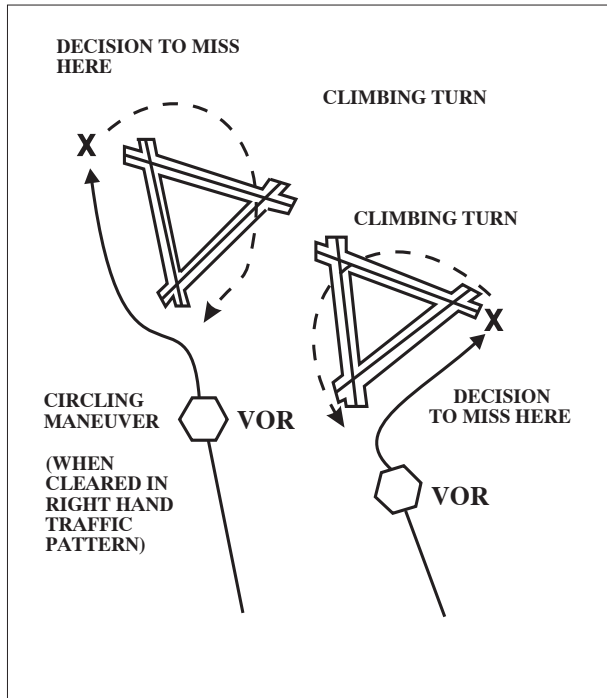
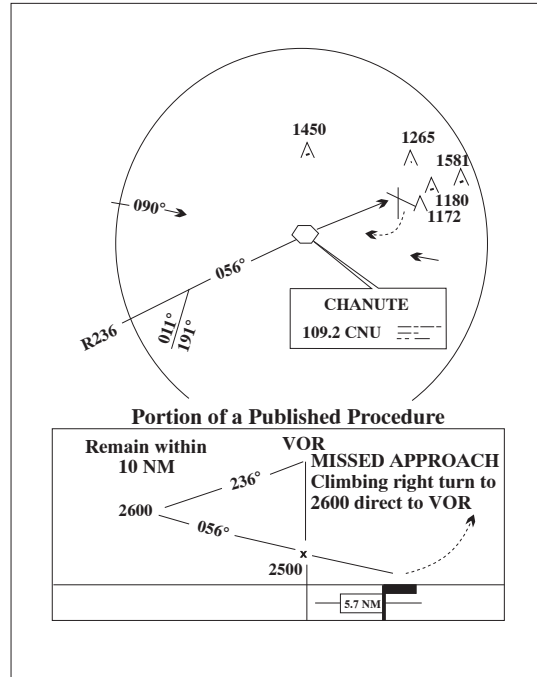

FIG 5-4-33
Missed Approach



In the event a bailed (rejected) landing occurs at a position other than the published missed approach point, the pilot should contact ATC as soon as possible to obtain an amended clearance. If unable to contact ATC for any reason, the pilot should attempt to re-intercept a published segment of the missed approach and comply with route and altitude instructions. If unable to contact ATC, and in the pilot's judgment it is no longer appropriate to fly the published missed approach procedure, then consider either maintaining visual conditions if practicable and reattempt a landing, or a circle-climb over the airport. Should a missed approach become necessary when operating to an airport that is not served by an operating control tower, continuous contact with an air traffic facility may not be possible. In this case, the pilot should execute the appropriate go-around/missed approach procedure without delay and contact ATC when able to do so.

Prior to initiating an instrument approach procedure, the pilot should assess the actions to be taken in the event of a bailed (rejected) landing beyond the missed approach point or below the MDA or DA (H) considering the anticipated weather conditions and available aircraft performance. 14 CFR 91.175(e) authorizes the pilot to fly an appropriate missed approach procedure that ensures obstruction clear-

ance, but it does not necessarily consider separation from other air traffic. The pilot must consider other factors such as the aircraft's geographical location with respect to the prescribed missed approach point, direction of flight, and/or minimum turning altitudes in the prescribed missed approach procedure. The pilot must also consider aircraft performance, visual climb restrictions, charted obstacles, published obstacle departure procedure, takeoff visual climb requirements as expressed by nonstandard takeoff minima, other traffic expected to be in the vicinity, or other factors not specifically expressed by the approach procedures.

5-4-22. Use of Enhanced Flight Vision Systems (EFVS) on Instrument Approaches

a. Introduction. An EFVS uses a head-up display (HUD), or an equivalent display that is a head-up presentation, to combine flight information, flight symbology, navigation guidance, and a real-time image of the external scene to the pilot on one display. Imaging sensors, which may be based on forward-looking infrared (FLIR), millimeter wave radiometry, millimeter wave radar, low-level light intensification, or other real-time imaging technologies produce a real-time image of the outside scene. During an instrument approach, an EFVS can enable a pilot to see the approach lights, visual references associated with the runway environment, and other objects or features that might not be visible using natural vision alone. Combining the flight information, navigation guidance, and sensor imagery on a HUD (or equivalent display) allows the pilot to continue looking forward along the flightpath throughout the entire approach, landing, and rollout.

An EFVS operation is an operation in which visibility conditions require an EFVS to be used in lieu of natural vision to perform an approach or landing, determine enhanced flight visibility, identify required visual references, or conduct a rollout. There are two types of EFVS operations:

1. EFVS operations to touchdown and rollout.
2. EFVS operations to 100 feet above the touchdown zone elevation (TDZE).

b. EFVS Operations to Touchdown and Rollout. An EFVS operation to touchdown and rollout is

an operation in which the pilot uses the enhanced vision imagery provided by an EFVS in lieu of natural vision to descend below DA or DH to touchdown and rollout. (See FIG 5-4-34.) These operations may be conducted only on Standard Instrument Approach Procedures (SIAP) or special IAPs that have a DA or DH (for example, precision or APV approach). An EFVS operation to touchdown and rollout may not be conducted on an approach that has circling minimums. The regulations for EFVS operations to touchdown and rollout can be found in 14 CFR § 91.176(a).

c. EFVS Operations to 100 Feet Above the TDZE. An EFVS operation to 100 feet above the TDZE is an operation in which the pilot uses the enhanced vision imagery provided by an EFVS in lieu of natural vision to descend below DA/DH or MDA down to 100 feet above the TDZE. (See FIG 5-4-35.) Natural vision must be used to descend below 100 feet above the TDZE to touchdown. These operations may be conducted on SIAPs or special IAPs that have a DA/DH or MDA. An EFVS operation to 100 feet above the TDZE may not be conducted on an approach that has circling minimums. The regulations for EFVS operations to 100 feet above the TDZE can be found in 14 CFR § 91.176(b).

d. EFVS Equipment Requirements. An EFVS that is installed on a U.S.-registered aircraft and is used to conduct EFVS operations must conform to an FAA-type design approval (i.e., a type certificate (TC), amended TC, or supplemental type certificate (STC)). A foreign-registered aircraft used to conduct EFVS operations that does not have an FAA-type design approval must be equipped with an EFVS that has been approved by either the State of the Operator or the State of Registry to meet the requirements of ICAO Annex 6. Equipment requirements for an EFVS operation to touchdown and rollout can be found in 14 CFR § 91.176(a)(1), and the equipment requirements for an EFVS operation to 100 feet above the TDZE can be found in 14 CFR § 91.176(b)(1). An operator can determine the eligibility of their aircraft to conduct EFVS operations by referring to the Airplane Flight Manual, Airplane Flight Manual Supplement, Rotorcraft Flight Manual, or Rotorcraft Flight Manual Supplement as applicable.

FIG 5-4-34
EFVS Operation to Touchdown and Rollout
[Photo provided by Google Earth]

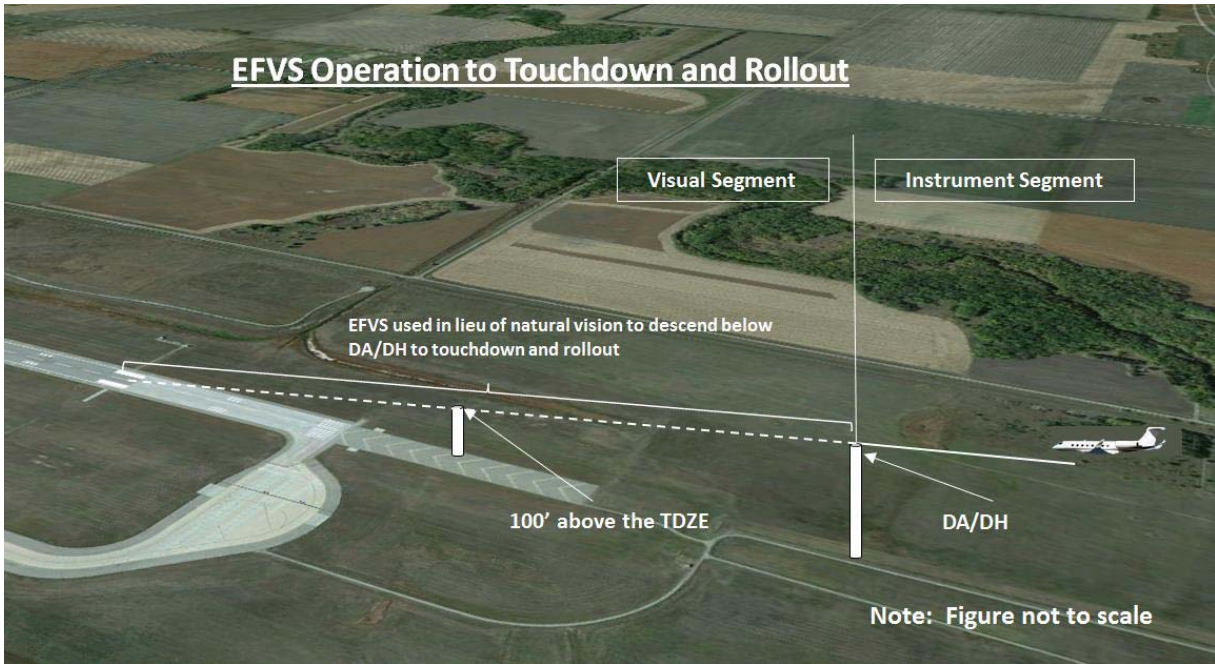
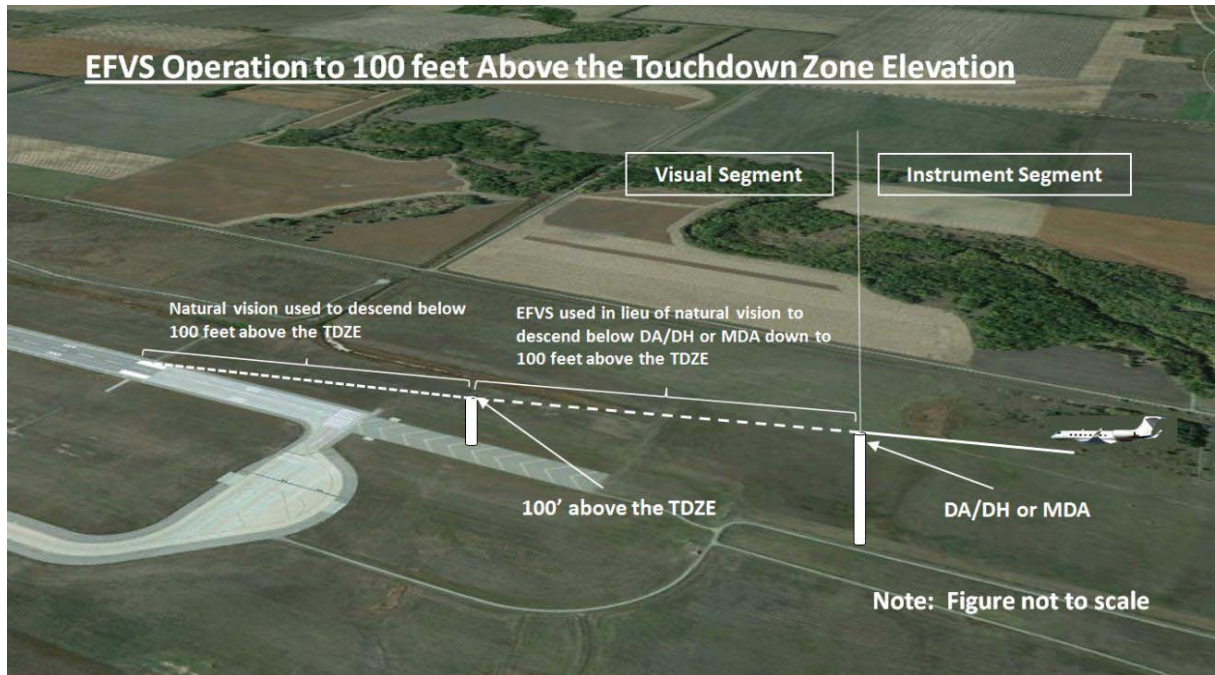

FIG 5-4-35
EFVS Operation to 100 ft Above the TDZE
[Photo provided by Google Earth]



e. Operating Requirements. Any operator who conducts EFVS operations to touchdown and rollout must have an OpSpec, MSpec, or LOA that specifically authorizes those operations. An operator's authorization to conduct EFVS operations to touchdown and rollout specifies a visibility minimum for the operation. Parts 91K, 121, 125, 129, and 135 operators who conduct EFVS operations to 100 feet above the TDZE must have an OpSpec, MSpec, or LOA that specifically authorizes the operation. Part 91 operators (other than 91K operators) are not required to have an LOA to conduct EFVS operations to 100 feet in the United States. Any operator conducting an EFVS operation during an authorized Category II or III operation must have an OpSpec, MSpec, or LOA authorizing EFVS operations during Category II or Category III operations.

f. Currently, EFVS operations in rotorcraft can only be conducted on IAPs that are flown to a runway. Instrument approach criteria, procedures, and appropriate visual references have not yet been developed for straight-in landing operations below DA/DH or MDA under IFR to heliports or platforms. An EFVS cannot be used in lieu of natural vision to descend below published minimums on copter approaches to a point in space (PinS) followed by a "proceed visual flight rules (VFR)" visual segment, or on approaches designed to a specific landing site using a "proceed visually" visual segment.

g. A pilot who conducts EFVS operations must receive ground and flight training specific to the EFVS operation to be conducted. The training must be obtained from an authorized training provider under a training program approved by the FAA. Additionally, recent flight experience and proficiency or competency check requirements apply to EFVS operations. These requirements are addressed in 14 CFR §§ 61.66, 91.1065, 121.441, Appendix F to Part 121, 125.287, and 135.293.

h. Enhanced Flight Visibility and Visual Reference Requirements. To descend below DA/DH or MDA during EFVS operations under 14 CFR § 91.176(a) or (b), a pilot must make a determination that the enhanced flight visibility observed by using an EFVS is not less than what is prescribed by the IAP being flown. In addition, the visual references required in 14 CFR § 91.176(a) or (b) must be distinctly visible and identifiable to the pilot using the EFVS. The determination of enhanced

flight visibility is a separate action from that of identifying required visual references, and is different from ground-reported visibility. Even though the reported visibility or the visibility observed using natural vision may be less, as long as the EFVS provides the required enhanced flight visibility and a pilot meets all of the other requirements, the pilot can continue descending below DA/DH or MDA using the EFVS. Suitable enhanced flight visibility is necessary to ensure the aircraft is in a position to continue the approach and land. It is important to understand that using an EFVS does not result in obtaining lower minima with respect to the visibility or the DA/DH or MDA specified in the IAP. An EFVS simply provides another means of operating in the visual segment of an IAP. The DA/DH or MDA and the visibility value specified in the IAP to be flown do not change.

i. Flight Planning and Beginning or Continuing an Approach Under IFR. 14 CFR Parts 121, 125, and 135 prohibit dispatching a flight, releasing a flight, taking off under IFR, or beginning or continuing an approach when weather conditions are less than the authorized minimums. A Part 121, 125, or 135 operator's OpSpec or LOA for EFVS operations authorizes a visibility for dispatching or releasing a flight and for beginning or continuing an approach. These operational minimums are based on the demonstrated performance of the EFVS. Once a pilot reaches DA/DH or MDA, the pilot conducts the EFVS operation in accordance with 14 CFR § 91.176(a) or (b) and their authorization to conduct EFVS operations.

j. Missed Approach Considerations. A missed approach after passing the DA/DH, or beyond the missed approach point (MAP), involves additional risk until established on the published missed approach segment. Initiating a go-around after passing the published MAP may result in loss of obstacle clearance. As with any approach, pilot planning should include contingencies between the published MAP and touchdown with reference to obstacle clearance, aircraft performance, and alternate escape plans.

k. Light Emitting Diode (LED) Airport Lighting Impact on EFVS Operations. Incandescent lamps have been replaced with LEDs at some airports in threshold lights, taxiway edge lights, taxiway centerline lights, low intensity runway edge lights, windcone lights, beacons, and some obstruction

lighting. Additionally, there are plans to replace incandescent lamps with LEDs in approach lighting systems. Pilots should be aware that LED lights cannot be sensed by infrared-based EFVSs. Further, the FAA does not currently collect or disseminate information about where LED lighting is installed.

l. Other Vision Systems. An Enhanced Vision System (EVS) does not meet the requirements of an EFVS. An EVS may present the sensor image on a head-down display and may not be able to present the image and flight symbology in the same scale and alignment as the outside view. An EVS can also use a HUD as its display element, yet still not meet the regulatory requirements for an EFVS. While an EVS that uses a head-down display or HUD may provide situation awareness to the pilot, it does not meet the operating requirements for an EFVS. Consequently, a pilot cannot use an EVS in lieu of natural vision to descend below DA/DH or MDA. Unlike an EFVS, a Synthetic Vision System (SVS) or Synthetic Vision Guidance System (SVGS) does not provide a real-time sensor image of the outside scene and also does not meet the equipment requirements for EFVS operations. A pilot cannot use a synthetic vision image on a head-up or a head-down display in lieu of natural vision to descend below DA/DH or MDA. An EFVS can, however, be integrated with an SVS, also known as a Combined Vision System (CVS). A CVS can be used to conduct EFVS operations if all of the requirements for an EFVS are satisfied and the SVS image does not interfere with the pilot's ability to see the external scene, to identify the required visual references, or to see the sensor image.

m. Additional Information. Operational criteria for EFVS can be found in Advisory Circular (AC) 90-106, Enhanced Flight Vision Systems, and airworthiness criteria for EFVS can be found in AC 20-167, Airworthiness Approval of Enhanced Vision System, Synthetic Vision System, Combined Vision System, and Enhanced Flight Vision System Equipment.

5-4-23. Visual Approach

a. A visual approach is conducted on an IFR flight plan and authorizes a pilot to proceed visually and clear of clouds to the airport. The pilot must have either the airport or the preceding identified aircraft in sight. This approach must be authorized and controlled by the appropriate air traffic control

facility. Reported weather at the airport must have a ceiling at or above 1,000 feet and visibility 3 miles or greater. ATC may authorize this type approach when it will be operationally beneficial. Visual approaches are an IFR procedure conducted under IFR in visual meteorological conditions. Cloud clearance requirements of 14 CFR Section 91.155 are not applicable, unless required by operation specifications.

b. Operating to an Airport Without Weather Reporting Service. ATC will advise the pilot when weather is not available at the destination airport. ATC may initiate a visual approach provided there is a reasonable assurance that weather at the airport is a ceiling at or above 1,000 feet and visibility 3 miles or greater (e.g., area weather reports, PIREPs, etc.).

c. Operating to an Airport With an Operating Control Tower. Aircraft may be authorized to conduct a visual approach to one runway while other aircraft are conducting IFR or VFR approaches to another parallel, intersecting, or converging runway. When operating to airports with parallel runways separated by less than 2,500 feet, the succeeding aircraft must report sighting the preceding aircraft unless standard separation is being provided by ATC. When operating to parallel runways separated by at least 2,500 feet but less than 4,300 feet, controllers will clear/vector aircraft to the final at an angle not greater than 30 degrees unless radar, vertical, or visual separation is provided during the turn-on. The purpose of the 30 degree intercept angle is to reduce the potential for overshoots of the final and to preclude side-by-side operations with one or both aircraft in a belly-up configuration during the turn-on. Once the aircraft are established within 30 degrees of final, or on the final, these operations may be conducted simultaneously. When the parallel runways are separated by 4,300 feet or more, or intersecting/converging runways are in use, ATC may authorize a visual approach after advising all aircraft involved that other aircraft are conducting operations to the other runway. This may be accomplished through use of the ATIS.

d. Separation Responsibilities. If the pilot has the airport in sight but cannot see the aircraft to be followed, ATC may clear the aircraft for a visual approach; however, ATC retains both separation and wake vortex separation responsibility. When visually following a preceding aircraft, acceptance of the visual approach clearance constitutes acceptance of

pilot responsibility for maintaining a safe approach interval and adequate wake turbulence separation.

e. A visual approach is not an IAP and therefore has no missed approach segment. If a go around is necessary for any reason, aircraft operating at controlled airports will be issued an appropriate advisory/clearance/instruction by the tower. At uncontrolled airports, aircraft are expected to remain clear of clouds and complete a landing as soon as possible. If a landing cannot be accomplished, the aircraft is expected to remain clear of clouds and contact ATC as soon as possible for further clearance. Separation from other IFR aircraft will be maintained under these circumstances.

f. Visual approaches reduce pilot/controller workload and expedite traffic by shortening flight paths to the airport. It is the pilot's responsibility to advise ATC as soon as possible if a visual approach is not desired.

g. Authorization to conduct a visual approach is an IFR authorization and does not alter IFR flight plan cancellation responsibility.

REFERENCE—
AIM Paragraph 5-1-15, Canceling IFR Flight Plan

h. Radar service is automatically terminated, without advising the pilot, when the aircraft is instructed to change to advisory frequency.

5-4-24. Charted Visual Flight Procedure (CVFP)

a. CVFPs are charted visual approaches established for environmental/noise considerations, and/or when necessary for the safety and efficiency of air traffic operations. The approach charts depict prominent landmarks, courses, and recommended altitudes to specific runways. CVFPs are designed to be used primarily for turbojet aircraft.

b. These procedures will be used only at airports with an operating control tower.

c. Most approach charts will depict some NAVAID information which is for supplemental navigational guidance only.

d. Unless indicating a Class B airspace floor, all depicted altitudes are for noise abatement purposes and are recommended only. Pilots are not prohibited

from flying other than recommended altitudes if operational requirements dictate.

e. When landmarks used for navigation are not visible at night, the approach will be annotated "*PROCEDURE NOT AUTHORIZED AT NIGHT.*"

f. CVFPs usually begin within 20 flying miles from the airport.

g. Published weather minimums for CVFPs are based on minimum vectoring altitudes rather than the recommended altitudes depicted on charts.

h. CVFPs are not instrument approaches and do not have missed approach segments.

i. ATC will not issue clearances for CVFPs when the weather is less than the published minimum.

j. ATC will clear aircraft for a CVFP after the pilot reports sighting a charted landmark or a preceding aircraft. If instructed to follow a preceding aircraft, pilots are responsible for maintaining a safe approach interval and wake turbulence separation.

k. Pilots should advise ATC if at any point they are unable to continue an approach or lose sight of a preceding aircraft. Missed approaches will be handled as a go-around.

5-4-25. Contact Approach

a. Pilots operating in accordance with an IFR flight plan, provided they are clear of clouds and have at least 1 mile flight visibility and can reasonably expect to continue to the destination airport in those conditions, may request ATC authorization for a contact approach.

b. Controllers may authorize a contact approach provided:

1. The contact approach is specifically requested by the pilot. ATC cannot initiate this approach.

EXAMPLE—
Request contact approach.

2. The reported ground visibility at the destination airport is at least 1 statute mile.

3. The contact approach will be made to an airport having a standard or special instrument approach procedure.

4. Approved separation is applied between aircraft so cleared and between these aircraft and other IFR or special VFR aircraft.

EXAMPLE—

Cleared contact approach (and, if required) at or below (altitude) (routing) if not possible (alternative procedures) and advise.

c. A contact approach is an approach procedure that may be used by a pilot (with prior authorization from ATC) in lieu of conducting a standard or special IAP to an airport. It is not intended for use by a pilot on an IFR flight clearance to operate to an airport not having a published and functioning IAP. Nor is it intended for an aircraft to conduct an instrument approach to one airport and then, when “in the clear,” discontinue that approach and proceed to another airport. In the execution of a contact approach, the pilot assumes the responsibility for obstruction clearance. If radar service is being received, it will automatically terminate when the pilot is instructed to change to advisory frequency.

5-4-26. Landing Priority

A clearance for a specific type of approach (ILS, RNAV, GLS, ADF, VOR or Visual Approach) to an aircraft operating on an IFR flight plan does not mean that landing priority will be given over other traffic. ATCTs handle all aircraft, regardless of the type of flight plan, on a “first-come, first-served” basis. Therefore, because of local traffic or runway in use, it may be necessary for the controller in the interest of safety, to provide a different landing sequence. In any case, a landing sequence will be issued to each aircraft as soon as possible to enable the pilot to properly adjust the aircraft’s flight path.

5-4-27. Overhead Approach Maneuver

a. Pilots operating in accordance with an IFR flight plan in Visual Meteorological Condi-

tions (VMC) may request ATC authorization for an overhead maneuver. An overhead maneuver is not an instrument approach procedure. Overhead maneuver patterns are developed at airports where aircraft have an operational need to conduct the maneuver. An aircraft conducting an overhead maneuver is considered to be VFR and the IFR flight plan is canceled when the aircraft reaches the initial point on the initial approach portion of the maneuver. (See FIG 5-4-36.) The existence of a standard overhead maneuver pattern does not eliminate the possible requirement for an aircraft to conform to conventional rectangular patterns if an overhead maneuver cannot be approved. Aircraft operating to an airport without a functioning control tower must initiate cancellation of an IFR flight plan prior to executing the overhead maneuver. Cancellation of the IFR flight plan must be accomplished after crossing the landing threshold on the initial portion of the maneuver or after landing. Controllers may authorize an overhead maneuver and issue the following to arriving aircraft:

1. Pattern altitude and direction of traffic. This information may be omitted if either is standard.

PHRASEOLOGY—

PATTERN ALTITUDE (altitude). RIGHT TURNS.

2. Request for a report on initial approach.

PHRASEOLOGY—

REPORT INITIAL.

3. “Break” information and a request for the pilot to report. The “Break Point” will be specified if nonstandard. Pilots may be requested to report “break” if required for traffic or other reasons.

PHRASEOLOGY—

BREAK AT (specified point).

REPORT BREAK.

FIG 5-4-36
Overhead Maneuver

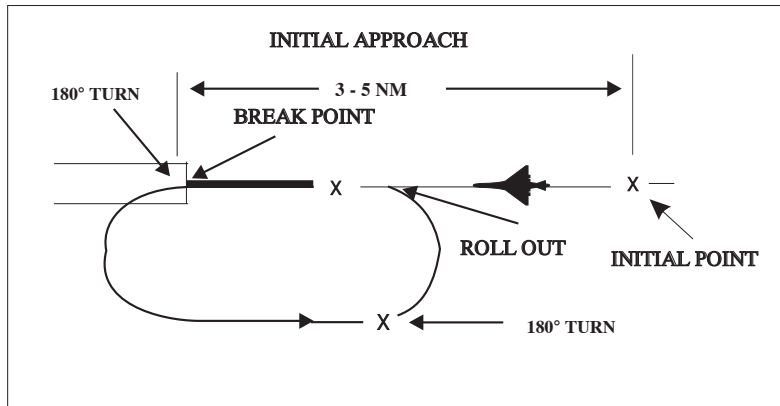

Section 5. Pilot/Controller Roles and Responsibilities

5-5-1. General

a. The roles and responsibilities of the pilot and controller for effective participation in the ATC system are contained in several documents. Pilot responsibilities are in the CFRs and the air traffic controllers' are in the FAA Order JO 7110.65, Air Traffic Control, and supplemental FAA directives. Additional and supplemental information for pilots can be found in the current Aeronautical Information Manual (AIM), Notices to Airmen, Advisory Circulars and aeronautical charts. Since there are many other excellent publications produced by nongovernment organizations, as well as other government organizations, with various updating cycles, questions concerning the latest or most current material can be resolved by cross-checking with the above mentioned documents.

b. The pilot-in-command of an aircraft is directly responsible for, and is the final authority as to the safe operation of that aircraft. In an emergency requiring immediate action, the pilot-in-command may deviate from any rule in the General Subpart A and Flight Rules Subpart B in accordance with 14 CFR Section 91.3.

c. The air traffic controller is responsible to give first priority to the separation of aircraft and to the issuance of radar safety alerts, second priority to other services that are required, but do not involve separation of aircraft and third priority to additional services to the extent possible.

d. In order to maintain a safe and efficient air traffic system, it is necessary that each party fulfill their responsibilities to the fullest.

e. The responsibilities of the pilot and the controller intentionally overlap in many areas providing a degree of redundancy. Should one or the other fail in any manner, this overlapping responsibility is expected to compensate, in many cases, for failures that may affect safety.

f. The following, while not intended to be all inclusive, is a brief listing of pilot and controller responsibilities for some commonly used procedures

or phases of flight. More detailed explanations are contained in other portions of this publication, the appropriate CFRs, ACs and similar publications. The information provided is an overview of the principles involved and is not meant as an interpretation of the rules nor is it intended to extend or diminish responsibilities.

5-5-2. Air Traffic Clearance

a. Pilot.

1. Acknowledges receipt and understanding of an ATC clearance.

2. Reads back any hold short of runway instructions issued by ATC.

3. Requests clarification or amendment, as appropriate, any time a clearance is not fully understood or considered unacceptable from a safety standpoint.

4. Promptly complies with an air traffic clearance upon receipt except as necessary to cope with an emergency. Advises ATC as soon as possible and obtains an amended clearance, if deviation is necessary.

NOTE-

A clearance to land means that appropriate separation on the landing runway will be ensured. A landing clearance does not relieve the pilot from compliance with any previously issued altitude crossing restriction.

b. Controller.

1. Issues appropriate clearances for the operation to be conducted, or being conducted, in accordance with established criteria.

2. Assigns altitudes in IFR clearances that are at or above the minimum IFR altitudes in controlled airspace.

3. Ensures acknowledgement by the pilot for issued information, clearances, or instructions.

4. Ensures that readbacks by the pilot of altitude, heading, or other items are correct. If incorrect, distorted, or incomplete, makes corrections as appropriate.

5-5-3. Contact Approach

a. Pilot.

1. Must request a contact approach and makes it in lieu of a standard or special instrument approach.

2. By requesting the contact approach, indicates that the flight is operating clear of clouds, has at least one mile flight visibility, and reasonably expects to continue to the destination airport in those conditions.

3. Assumes responsibility for obstruction clearance while conducting a contact approach.

4. Advises ATC immediately if unable to continue the contact approach or if encounters less than 1 mile flight visibility.

5. Is aware that if radar service is being received, it may be automatically terminated when told to contact the tower.

REFERENCE-
Pilot/Controller Glossary Term – Radar Service Terminated.

b. Controller.

1. Issues clearance for a contact approach only when requested by the pilot. Does not solicit the use of this procedure.

2. Before issuing the clearance, ascertains that reported ground visibility at destination airport is at least 1 mile.

3. Provides approved separation between the aircraft cleared for a contact approach and other IFR or special VFR aircraft. When using vertical separation, does not assign a fixed altitude, but clears the aircraft at or below an altitude which is at least 1,000 feet below any IFR traffic but not below Minimum Safe Altitudes prescribed in 14 CFR Section 91.119.

4. Issues alternative instructions if, in their judgment, weather conditions may make completion of the approach impracticable.

5-5-4. Instrument Approach

a. Pilot.

1. Be aware that the controller issues clearance for approach based only on known traffic.

2. Follows the procedure as shown on the IAP, including all restrictive notations, such as:

- (a) Procedure not authorized at night;

- (b) Approach not authorized when local area altimeter not available;

- (c) Procedure not authorized when control tower not in operation;

- (d) Procedure not authorized when glide slope not used;

- (e) Straight-in minimums not authorized at night; etc.

- (f) Radar required; or

- (g) The circling minimums published on the instrument approach chart provide adequate obstruction clearance and pilots should not descend below the circling altitude until the aircraft is in a position to make final descent for landing. Sound judgment and knowledge of the pilot's and the aircraft's capabilities are the criteria for determining the exact maneuver in each instance since airport design and the aircraft position, altitude and airspeed must all be considered.

REFERENCE-
AIM, Paragraph 5-4-20, Approach and Landing Minimums

3. Upon receipt of an approach clearance while on an unpublished route or being radar vectored:

- (a) Complies with the minimum altitude for IFR; and

- (b) Maintains the last assigned altitude until established on a segment of a published route or IAP, at which time published altitudes apply.

4. When applicable, apply cold temperature correction to instrument approach segments. Advise ATC when intending to apply cold temperature correction and of the amount of correction required for each affected segment on initial contact (or as soon as possible). This information is required for ATC to provide aircraft appropriate vertical separation between known traffic.

REFERENCE-
AIM, Paragraph 7-2-3, Altimeter Errors
AIM, TBL 7-2-3, ICAO Cold Temperature Error

b. Controller.

1. Issues an approach clearance based on known traffic.

2. Issues an IFR approach clearance only after the aircraft is established on a segment of published route or IAP, or assigns an appropriate altitude for the aircraft to maintain until so established.

5-5-5. Missed Approach

a. Pilot.

1. Executes a missed approach when one of the following conditions exist:

(a) Arrival at the Missed Approach Point (MAP) or the Decision Height (DH) and visual reference to the runway environment is insufficient to complete the landing.

(b) Determines that a safe approach or landing is not possible (see subparagraph 5-4-21h).

(c) Instructed to do so by ATC.

2. Advises ATC that a missed approach will be made. Include the reason for the missed approach unless the missed approach is initiated by ATC.

3. Complies with the missed approach instructions for the IAP being executed from the MAP, unless other missed approach instructions are specified by ATC.

4. If executing a missed approach prior to reaching the MAP, fly the lateral navigation path of the instrument procedure to the MAP. Climb to the altitude specified in the missed approach procedure, except when a maximum altitude is specified between the final approach fix (FAF) and the MAP. In that case, comply with the maximum altitude restriction. Note, this may require a continued descent on the final approach.

5. When applicable, apply cold temperature correction to the published missed approach segment. Advise ATC when intending to apply cold temperature correction and of the amount of correction required on initial contact (or as soon as possible). This information is required for ATC to provide aircraft appropriate vertical separation between known traffic. The pilot must not apply an altitude correction to an assigned altitude when provided an initial heading to fly or radar vector in lieu of published missed approach procedures, unless approved by ATC.

REFERENCE-

AIM, Paragraph 7-2-3, Altitude Errors

AIM, TBL 7-2-3, ICAO Cold Temperature Error

6. Following a missed approach, requests clearance for specific action; i.e., another approach, hold for improved conditions, proceed to an alternate airport, etc.

b. Controller.

1. Issues an approved alternate missed approach procedure if it is desired that the pilot execute a procedure other than as depicted on the instrument approach chart.

2. May vector a radar identified aircraft executing a missed approach when operationally advantageous to the pilot or the controller.

3. In response to the pilot's stated intentions, issues a clearance to an alternate airport, to a holding fix, or for reentry into the approach sequence, as traffic conditions permit.

5-5-6. Radar Vectors

a. Pilot.

1. Promptly complies with headings and altitudes assigned to you by the controller.

2. Questions any assigned heading or altitude believed to be incorrect.

3. If operating VFR and compliance with any radar vector or altitude would cause a violation of any CFR, advises ATC and obtains a revised clearance or instructions.

b. Controller.

1. Vectors aircraft in Class A, Class B, Class C, Class D, and Class E airspace:

(a) For separation.

(b) For noise abatement.

(c) To obtain an operational advantage for the pilot or controller.

2. Vectors aircraft in Class A, Class B, Class C, Class D, Class E, and Class G airspace when requested by the pilot.

3. Vectors IFR aircraft at or above minimum vectoring altitudes.

4. May vector VFR aircraft, not at an ATC assigned altitude, at any altitude. In these cases, terrain separation is the pilot's responsibility.

5-5-7. Safety Alert

a. Pilot.

1. Initiates appropriate action if a safety alert is received from ATC.

2. Be aware that this service is not always available and that many factors affect the ability of the controller to be aware of a situation in which unsafe proximity to terrain, obstructions, or another aircraft may be developing.

b. Controller.

1. Issues a safety alert if aware an aircraft under their control is at an altitude which, in the controller's judgment, places the aircraft in unsafe proximity to terrain, obstructions or another aircraft. Types of safety alerts are:

(a) **Terrain or Obstruction Alert.** Immediately issued to an aircraft under their control if aware the aircraft is at an altitude believed to place the aircraft in unsafe proximity to terrain or obstructions.

(b) **Aircraft Conflict Alert.** Immediately issued to an aircraft under their control if aware of an aircraft not under their control at an altitude believed to place the aircraft in unsafe proximity to each other. With the alert, they offer the pilot an alternative, if feasible.

2. Discontinue further alerts if informed by the pilot action is being taken to correct the situation or that the other aircraft is in sight.

5-5-8. See and Avoid

a. **Pilot.** When meteorological conditions permit, regardless of type of flight plan or whether or not under control of a radar facility, the pilot is responsible to see and avoid other traffic, terrain, or obstacles.

b. Controller.

1. Provides radar traffic information to radar identified aircraft operating outside positive control airspace on a workload permitting basis.

2. Issues safety alerts to aircraft under their control if aware the aircraft is at an altitude believed to place the aircraft in unsafe proximity to terrain, obstructions, or other aircraft.

5-5-9. Speed Adjustments

a. Pilot.

1. Advises ATC any time cruising airspeed varies plus or minus 5 percent or 10 knots, whichever is greater, from that given in the flight plan.

2. Complies with speed adjustments from ATC unless:

(a) The minimum or maximum safe airspeed for any particular operation is greater or less than the requested airspeed. In such cases, advises ATC.

NOTE-

It is the pilot's responsibility and prerogative to refuse speed adjustments considered excessive or contrary to the aircraft's operating specifications.

(b) Operating at or above 10,000 feet MSL on an ATC assigned SPEED ADJUSTMENT of more than 250 knots IAS and subsequent clearance is received for descent below 10,000 feet MSL. In such cases, pilots are expected to comply with 14 CFR Section 91.117(a).

3. When complying with speed adjustment assignments, maintains an indicated airspeed within plus or minus 10 knots or 0.02 Mach number of the specified speed.

b. Controller.

1. Assigns speed adjustments to aircraft when necessary but not as a substitute for good vectoring technique.

2. Adheres to the restrictions published in FAA Order JO 7110.65, Air Traffic Control, as to when speed adjustment procedures may be applied.

3. Avoids speed adjustments requiring alternate decreases and increases.

4. Assigns speed adjustments to a specified IAS (KNOTS)/Mach number or to increase or decrease speed using increments of 5 knots or multiples thereof.

5. Terminates ATC-assigned speed adjustments when no longer required by issuing further instructions to pilots in the following manner:

(a) Advises pilots to "resume normal speed" when the aircraft is on a heading, random routing, charted procedure, or route without published speed restrictions.

(b) Instructs pilots to "comply with speed restrictions" when the aircraft is joining or resuming a charted procedure or route with published speed restrictions.

CAUTION-

The phraseology "Climb via SID" requires compliance with all altitude and/or speed restrictions depicted on the procedure.

(c) Instructs pilots to “resume published speed” when aircraft are cleared via a charted instrument flight procedure that contains published speed restrictions.

(d) Advises aircraft to “delete speed restrictions” when ATC assigned or published speed restrictions on a charted procedure are no longer required.

(e) Clears pilots for approach without restating previously issued speed adjustments.

REFERENCE–

Pilot/Controller Glossary Term– Resume Normal Speed
Pilot/Controller Glossary Term– Resume Published Speed

6. Gives due consideration to aircraft capabilities to reduce speed while descending.

7. Does not assign speed adjustments to aircraft at or above FL 390 without pilot consent.

5–5–10. Traffic Advisories (Traffic Information)

a. Pilot.

1. Acknowledges receipt of traffic advisories.
2. Informs controller if traffic in sight.
3. Advises ATC if a vector to avoid traffic is desired.
4. Does not expect to receive radar traffic advisories on all traffic. Some aircraft may not appear on the radar display. Be aware that the controller may be occupied with higher priority duties and unable to issue traffic information for a variety of reasons.
5. Advises controller if service is not desired.

b. Controller.

1. Issues radar traffic to the maximum extent consistent with higher priority duties except in Class A airspace.
2. Provides vectors to assist aircraft to avoid observed traffic when requested by the pilot.
3. Issues traffic information to aircraft in the Class B, Class C, and Class D surface areas for sequencing purposes.
4. Controllers are required to issue to each aircraft operating on intersecting or nonintersecting

converging runways where projected flight paths will cross.

5–5–11. Visual Approach

a. Pilot.

1. If a visual approach is not desired, advises ATC.

2. Complies with controller’s instructions for vectors toward the airport of intended landing or to a visual position behind a preceding aircraft.

3. The pilot must, at all times, have either the airport or the preceding aircraft in sight. After being cleared for a visual approach, proceed to the airport in a normal manner or follow the preceding aircraft. Remain clear of clouds while conducting a visual approach.

4. If the pilot accepts a visual approach clearance to visually follow a preceding aircraft, you are required to establish a safe landing interval behind the aircraft you were instructed to follow. You are responsible for wake turbulence separation.

5. Advise ATC immediately if the pilot is unable to continue following the preceding aircraft, cannot remain clear of clouds, needs to climb, or loses sight of the airport.

6. Be aware that radar service is automatically terminated, without being advised by ATC, when the pilot is instructed to change to advisory frequency.

7. Be aware that there may be other traffic in the traffic pattern and the landing sequence may differ from the traffic sequence assigned by approach control or ARTCC.

b. Controller.

1. Do not clear an aircraft for a visual approach unless reported weather at the airport is ceiling at or above 1,000 feet and visibility is 3 miles or greater. When weather is not available for the destination airport, inform the pilot and do not initiate a visual approach to that airport unless there is reasonable assurance that descent and flight to the airport can be made visually.

2. Issue visual approach clearance when the pilot reports sighting either the airport or a preceding aircraft which is to be followed.

3. Provide separation except when visual separation is being applied by the pilot.

4. Continue flight following and traffic information until the aircraft has landed or has been instructed to change to advisory frequency.

5. For all aircraft, inform the pilot when the preceding aircraft is a heavy. Inform the pilot of a small aircraft when the preceding aircraft is a B757. Visual separation is prohibited behind super aircraft.

6. When weather is available for the destination airport, do not initiate a vector for a visual approach unless the reported ceiling at the airport is 500 feet or more above the MVA and visibility is 3 miles or more. If vectoring weather minima are not available but weather at the airport is ceiling at or above 1,000 feet and visibility of 3 miles or greater, visual approaches may still be conducted.

5-5-12. Visual Separation

a. Pilot.

1. Acceptance of instructions to follow another aircraft or to provide visual separation from it is an acknowledgment that the pilot will maneuver the aircraft as necessary to avoid the other aircraft or to maintain in-trail separation. Pilots are responsible to maintain visual separation until flight paths (altitudes and/or courses) diverge.

2. If instructed by ATC to follow another aircraft or to provide visual separation from it, promptly notify the controller if you lose sight of that aircraft, are unable to maintain continued visual contact with it, or cannot accept the responsibility for your own separation for any reason.

3. The pilot also accepts responsibility for wake turbulence separation under these conditions.

b. Controller. Applies visual separation only:

1. Within the terminal area when a controller has both aircraft in sight or by instructing a pilot who sees the other aircraft to maintain visual separation from it.

2. Pilots are responsible to maintain visual separation until flight paths (altitudes and/or courses) diverge.

3. Within en route airspace when aircraft are on opposite courses and one pilot reports having seen the other aircraft and that the aircraft have passed each other.

5-5-13. VFR-on-top

a. Pilot.

1. This clearance must be requested by the pilot on an IFR flight plan, and if approved, allows the pilot the choice (subject to any ATC restrictions) to select an altitude or flight level in lieu of an assigned altitude.

NOTE-

VFR-on-top is not permitted in certain airspace areas, such as Class A airspace, certain restricted areas, etc. Consequently, IFR flights operating VFR-on-top will avoid such airspace.

REFERENCE-

*AIM, Paragraph 4-4-8, IFR Clearance VFR-on-top
AIM, Paragraph 4-4-11, IFR Separation Standards
AIM, Paragraph 5-3-2, Position Reporting
AIM, Paragraph 5-3-3, Additional Reports*

2. By requesting a VFR-on-top clearance, the pilot assumes the sole responsibility to be vigilant so as to see and avoid other aircraft and to:

(a) Fly at the appropriate VFR altitude as prescribed in 14 CFR Section 91.159.

(b) Comply with the VFR visibility and distance from clouds criteria in 14 CFR Section 91.155, *Basic VFR Weather Minimums*.

(c) Comply with instrument flight rules that are applicable to this flight; i.e., minimum IFR altitudes, position reporting, radio communications, course to be flown, adherence to ATC clearance, etc.

3. Should advise ATC prior to any altitude change to ensure the exchange of accurate traffic information.

b. Controller.

1. May clear an aircraft to maintain VFR-on-top if the pilot of an aircraft on an IFR flight plan requests the clearance.

2. Informs the pilot of an aircraft cleared to climb to VFR-on-top the reported height of the tops or that no top report is available; issues an alternate clearance if necessary; and once the aircraft reports reaching VFR-on-top, reclears the aircraft to maintain VFR-on-top.

3. Before issuing clearance, ascertain that the aircraft is not in or will not enter Class A airspace.

5-5-14. Instrument Departures

a. Pilot.

1. Prior to departure considers the type of terrain and other obstructions on or in the vicinity of the departure airport.

2. Determines if obstruction avoidance can be maintained visually or that the departure procedure should be followed.

3. Determines whether an obstacle departure procedure (ODP) and/or DP is available for obstruction avoidance. One option may be a Visual Climb Over Airport (VCOA). Pilots must advise ATC as early as possible of the intent to fly the VCOA prior to departure.

4. At airports where IAPs have not been published, hence no published departure procedure, determines what action will be necessary and takes such action that will assure a safe departure.

b. Controller.

1. At locations with airport traffic control service, when necessary, specifies direction of takeoff, turn, or initial heading to be flown after takeoff, consistent with published departure procedures (DP) or diverse vector areas (DVA), where applicable.

2. At locations without airport traffic control service but within Class E surface area when necessary to specify direction of takeoff, turn, or initial heading to be flown, obtains pilot's concurrence that the procedure will allow the pilot to comply with local traffic patterns, terrain, and obstruction avoidance.

3. When the initial heading will take the aircraft off an assigned procedure (for example, an RNAV SID with a published lateral path to a waypoint and crossing restrictions from the departure end of runway), the controller will assign an altitude to maintain with the initial heading.

4. Includes established departure procedures as part of the ATC clearance when pilot compliance is necessary to ensure separation.

5-5-15. Minimum Fuel Advisory

a. Pilot.

1. Advise ATC of your minimum fuel status when your fuel supply has reached a state where, upon reaching destination, you cannot accept any undue delay.

2. Be aware this is not an emergency situation, but merely an advisory that indicates an emergency situation is possible should any undue delay occur.

3. On initial contact the term "minimum fuel" should be used after stating call sign.

EXAMPLE-

Salt Lake Approach, United 621, "minimum fuel."

4. Be aware a minimum fuel advisory does not imply a need for traffic priority.

5. If the remaining usable fuel supply suggests the need for traffic priority to ensure a safe landing, you should declare an emergency due to low fuel and report fuel remaining in minutes.

REFERENCE-

Pilot/Controller Glossary Term- Fuel Remaining.

b. Controller.

1. When an aircraft declares a state of minimum fuel, relay this information to the facility to whom control jurisdiction is transferred.

2. Be alert for any occurrence which might delay the aircraft.

5-5-16. RNAV and RNP Operations

a. Pilot.

1. If unable to comply with the requirements of an RNAV or RNP procedure, pilots must advise air traffic control as soon as possible. For example, "N1234, failure of GPS system, unable RNAV, request amended clearance."

2. Pilots are not authorized to fly a published RNAV or RNP procedure (instrument approach, departure, or arrival procedure) unless it is retrievable by the procedure name from the current aircraft navigation database and conforms to the charted procedure. The system must be able to retrieve the procedure by name from the aircraft navigation database, not just as a manually entered series of waypoints.

3. Whenever possible, RNAV routes (Q- or T-route) should be extracted from the database in

their entirety, rather than loading RNAV route waypoints from the database into the flight plan individually. However, selecting and inserting individual, named fixes from the database is permitted, provided all fixes along the published route to be flown are inserted.

4. Pilots must not change any database waypoint type from a fly-by to fly-over, or vice versa. No other modification of database waypoints or the creation of user-defined waypoints on published RNAV or RNP procedures is permitted, except to:

(a) Change altitude and/or airspeed waypoint constraints to comply with an ATC clearance/instruction.

(b) Insert a waypoint along the published route to assist in complying with ATC instruction, example, “Descend via the WILMS arrival except cross 30 north of BRUCE at/or below FL 210.” This is limited only to systems that allow along-track waypoint construction.

5. Pilots of FMS-equipped aircraft, who are assigned an RNAV DP or STAR procedure and subsequently receive a change of runway, transition or procedure, must verify that the appropriate changes are loaded and available for navigation.

6. For RNAV 1 DPs and STARs, pilots must use a CDI, flight director and/or autopilot, in lateral navigation mode. Other methods providing an equivalent level of performance may also be acceptable.

7. For RNAV 1 DPs and STARs, pilots of aircraft without GPS, using DME/DME/IRU, must ensure the aircraft navigation system position is confirmed, within 1,000 feet, at the start point of take-off roll. The use of an automatic or manual runway update is an acceptable means of compliance with this requirement. Other methods providing an equivalent level of performance may also be acceptable.

8. For procedures or routes requiring the use of GPS, if the navigation system does not automatically alert the flight crew of a loss of GPS, the operator

must develop procedures to verify correct GPS operation.

9. RNAV terminal procedures (DP and STAR) may be amended by ATC issuing radar vectors and/or clearances direct to a waypoint. Pilots should avoid premature manual deletion of waypoints from their active “legs” page to allow for rejoining procedures.

10. RAIM Prediction: If TSO-C129 equipment is used to solely satisfy the RNAV and RNP requirement, GPS RAIM availability must be confirmed for the intended route of flight (route and time). If RAIM is not available, pilots need an approved alternate means of navigation.

REFERENCE-

AIM, Paragraph 5-1-16, RNAV and RNP Operations

11. Definition of “established” for RNAV and RNP operations. An aircraft is considered to be established on-course during RNAV and RNP operations anytime it is within 1 times the required accuracy for the segment being flown. For example, while operating on a Q-Route (RNAV 2), the aircraft is considered to be established on-course when it is within 2 NM of the course centerline.

NOTE-

1. *Pilots must be aware of how their navigation system operates, along with any AFM limitations, and confirm that the aircraft’s lateral deviation display (or map display if being used as an allowed alternate means) is suitable for the accuracy of the segment being flown. Automatic scaling and alerting changes are appropriate for some operations. For example, TSO-C129 systems change within 30 miles of destination and within 2 miles of FAF to support approach operations. For some navigation systems and operations, manual selection of scaling will be necessary.*

2. *Pilots flying FMS equipped aircraft with barometric vertical navigation (Baro-VNAV) may descend when the aircraft is established on-course following FMS leg transition to the next segment. Leg transition normally occurs at the turn bisector for a fly-by waypoint (reference paragraph 1-2-1 for more on waypoints). When using full automation, pilots should monitor the aircraft to ensure the aircraft is turning at appropriate lead times and descending once established on-course.*

3. *Pilots flying TSO-C129 navigation system equipped aircraft without full automation should use normal lead points to begin the turn. Pilots may descend when established on-course on the next segment of the approach.*

Section 6. National Security and Interception Procedures

5-6-1. National Security

National security in the control of air traffic is governed by 14 Code of Federal Regulations (CFR) Part 99, *Security Control of Air Traffic*.

5-6-2. National Security Requirements

a. Pursuant to 14 CFR 99.7, *Special Security Instructions*, each person operating an aircraft in an Air Defense Identification Zone (ADIZ) or Defense Area must, in addition to the applicable rules of Part 99, comply with special security instructions issued by the FAA Administrator in the interest of national security, pursuant to agreement between the FAA and the Department of Defense (DOD), or between the FAA and a U.S. Federal security or intelligence agency.

b. In addition to the requirements prescribed in this section, national security requirements for aircraft operations to or from, within, or transiting U.S. territorial airspace are in effect pursuant to 14 CFR 99.7; 49 United States Code (USC) 40103, *Sovereignty and Use of Airspace*; and 49 USC 41703, *Navigation of Foreign Civil Aircraft*. Aircraft operations to or from, within, or transiting U.S. territorial airspace must also comply with all other applicable regulations published in 14 CFR.

c. Due to increased security measures in place at many areas and in accordance with 14 CFR 91.103, *Preflight Action*, prior to departure, pilots must become familiar with all available information concerning that flight. Pilots are responsible to comply with 14 CFR 91.137 (*Temporary flight restrictions in the vicinity of disaster/hazard areas*), 91.138 (*Temporary flight restrictions in national disaster areas in the State of Hawaii*), 91.141 (*Flight restrictions in the proximity of the Presidential and other parties*), and 91.143 (*Flight limitation in the proximity of space flight operations*) when conducting flight in an area where a temporary flight restrictions area is in effect, and should check appropriate NOTAMs during flight planning. In addition, NOTAMs may be issued for National Security Areas (NSA) that temporarily prohibit flight operations under the provisions of 14 CFR 99.7.

REFERENCE-

AIM, Paragraph 3-4-8, National Security Areas

AIM, Paragraph 3-5-3, Temporary Flight Restrictions

d. Noncompliance with the national security requirements for aircraft operations contained in this section may result in denial of flight entry into U.S. territorial airspace or ground stop of the flight at a U.S. airport.

e. Pilots of aircraft that do not adhere to the procedures in the national security requirements for aircraft operations contained in this section may be intercepted, and/or detained and interviewed by federal, state, or local law enforcement or other government personnel.

5-6-3. Definitions

a. *Air Defense Identification Zone (ADIZ)* means an area of airspace over land or water, in which the ready identification, location, and control of all aircraft (except Department of Defense and law enforcement aircraft) is required in the interest of national security.

b. *Defense Area* means any airspace of the contiguous U.S. that is not an ADIZ in which the control of aircraft is required for reasons of national security.

c. *U.S. territorial airspace*, for the purposes of this section, means the airspace over the U.S., its territories, and possessions, and the airspace over the territorial sea of the U.S., which extends 12 nautical miles from the baselines of the U.S., determined in accordance with international law.

d. *To U.S. territorial airspace* means any flight that enters U.S. territorial airspace after departure from a location outside of the U.S., its territories or possessions, for landing at a destination in the U.S., its territories or possessions.

e. *From U.S. territorial airspace* means any flight that exits U.S. territorial airspace after departure from a location in the U.S., its territories or possessions, and lands at a destination outside the U.S., its territories or possessions.

f. *Within U.S. territorial airspace* means any flight departing from a location inside of the U.S., its territories or possessions, which operates en route to

a location inside the U.S., its territories or possessions.

g. Transit or transiting U.S. territorial airspace means any flight departing from a location outside of the U.S., its territories or possessions, which operates in U.S. territorial airspace en route to a location outside the U.S., its territories or possessions without landing at a destination in the U.S., its territories or possessions.

h. Aeronautical facility, for the purposes of this section, means a communications facility where flight plans or position reports are normally filed during flight operations.

5-6-4. ADIZ Requirements

a. To facilitate early identification of all aircraft in the vicinity of U.S. airspace boundaries, Air Defense Identification Zones (ADIZ) have been established. All aircraft must meet certain requirements to facilitate early identification when operating into, within, and across an ADIZ, as described in 14 CFR 99.

b. Requirements for aircraft operations are as follows:

1. Transponder Requirements. Unless otherwise authorized by ATC, each aircraft conducting operations into, within, or across the contiguous U.S. ADIZ must be equipped with an operable radar beacon transponder having altitude reporting capability, and that transponder must be turned on and set to reply on the appropriate code or as assigned by ATC. (See 14 CFR 99.13, *Transponder-On Requirements*, for additional information.)

2. Two-way Radio. In accordance with 14 CFR 99.9, *Radio Requirements*, any person operating in an ADIZ must maintain two-way radio communication with an appropriate aeronautical facility. For two-way radio communications failure, follow instructions contained in 14 CFR 99.9.

3. Flight Plan. In accordance with 14 CFR 99.11, *Flight Plan Requirements*, and 14 CFR 99.9, except as specified in subparagraph 5-6-4e, no person may operate an aircraft into, within, or from a departure point within an ADIZ, unless the person files, activates, and closes a flight plan with an appropriate aeronautical facility, or is otherwise authorized by air traffic control as follows:

(a) Pilots must file an Instrument Flight Rules (IFR) flight plan or file a Defense Visual Flight Rules (DVFR) flight plan containing the time and point of ADIZ penetration;

(b) The pilot must activate the DVFR flight plan with U.S. Flight Service and set the aircraft transponder to the assigned discrete beacon code prior to entering the ADIZ;

(c) The IFR or DVFR aircraft must depart within 5 minutes of the estimated departure time contained in the flight plan, except for (d) below;

(d) If the airport of departure within the Alaskan ADIZ has no facility for filing a flight plan, the flight plan must be filed immediately after takeoff or when within range of an appropriate aeronautical facility;

(e) State aircraft (U.S. or foreign) planning to operate through an ADIZ should enter ICAO Code M in Item 8 of the flight plan to assist in identification of the aircraft as a state aircraft.

c. Position Reporting Before Penetration of ADIZ.

In accordance with 14 CFR 99.15, *Position Reports*, before entering the ADIZ, the pilot must report to an appropriate aeronautical facility as follows:

1. IFR flights in controlled airspace. The pilot must maintain a continuous watch on the appropriate frequency and report the time and altitude of passing each designated reporting point or those reporting points specified or requested by ATC, except that while the aircraft is under radar control, only the passing of those reporting points specifically requested by ATC need be reported. (See 14 CFR 91.183(a), *IFR Communications*.)

2. DVFR flights and IFR flights in uncontrolled airspace:

(a) The time, position, and altitude at which the aircraft passed the last reporting point before penetration and the estimated time of arrival over the next appropriate reporting point along the flight route;

(b) If there is no appropriate reporting point along the flight route, the pilot reports at least 15 minutes before penetration: the estimated time, position, and altitude at which the pilot will penetrate; or

(c) If the departure airport is within an ADIZ or so close to the ADIZ boundary that it prevents the

pilot from complying with (a) or (b) above, the pilot must report immediately after departure: the time of departure, the altitude, and the estimated time of arrival over the first reporting point along the flight route.

3. Foreign civil aircraft. If the pilot of a foreign civil aircraft that intends to enter the U.S. through an ADIZ cannot comply with the reporting requirements in subparagraphs c1 or c2 above, as applicable, the pilot must report the position of the aircraft to the appropriate aeronautical facility not less than 1 hour and not more than 2 hours average direct cruising distance from the U.S.

d. Land-Based ADIZ. Land-Based ADIZ are activated and deactivated over U.S. metropolitan areas as needed, with dimensions, activation dates and other relevant information disseminated via NOTAM. Pilots unable to comply with all NOTAM requirements must remain clear of Land-Based ADIZ. Pilots entering a Land-Based ADIZ without authorization or who fail to follow all requirements risk interception by military fighter aircraft.

e. Exceptions to ADIZ requirements.

1. Except for the national security requirements in paragraph 5-6-2, transponder requirements in subparagraph 5-6-4b1, and position reporting in subparagraph 5-6-4c, the ADIZ requirements in 14 CFR Part 99 described in this section do not apply to the following aircraft operations pursuant to Section 99.1(b), Applicability:

(a) Within the 48 contiguous States or within the State of Alaska, on a flight which remains within 10 NM of the point of departure;

(b) Operating at true airspeed of less than 180 knots in the Hawaii ADIZ or over any island, or within 12 NM of the coastline of any island, in the Hawaii ADIZ;

(c) Operating at true airspeed of less than 180 knots in the Alaska ADIZ while the pilot maintains a continuous listening watch on the appropriate frequency; or

(d) Operating at true airspeed of less than 180 knots in the Guam ADIZ.

2. An FAA air route traffic control center (ARTCC) may exempt certain aircraft operations on a local basis in concurrence with the DOD or pursuant to an agreement with a U.S. Federal security or

intelligence agency. (See 14 CFR 99.1 for additional information.)

f. A VFR flight plan filed inflight makes an aircraft subject to interception for positive identification when entering an ADIZ. Pilots are therefore urged to file the required DVFR flight plan either in person or by telephone prior to departure when able.

5-6-5. Civil Aircraft Operations To or From U.S. Territorial Airspace

a. Civil aircraft, except as described in subparagraph 5-6-5b below, are authorized to operate to or from U.S. territorial airspace if in compliance with all of the following conditions:

1. File and are on an active flight plan (IFR, VFR, or DVFR);

2. Are equipped with an operational transponder with altitude reporting capability, and continuously squawk an ATC assigned transponder code;

3. Maintain two-way radio communications with ATC;

4. Comply with all other applicable ADIZ requirements described in paragraph 5-6-4 and any other national security requirements in paragraph 5-6-2;

5. Comply with all applicable U.S. Customs and Border Protection (CBP) requirements, including Advance Passenger Information System (APIS) requirements (see subparagraph 5-6-5c below for CBP APIS information), in accordance with 19 CFR Part 122, *Air Commerce Regulations*; and

6. Are in receipt of, and are operating in accordance with, an FAA routing authorization if the aircraft is registered in a U.S. State Department-designated special interest country or is operating with the ICAO three letter designator (3LD) of a company in a country listed as a U.S. State Department-designated special interest country, unless the operator holds valid FAA Part 129 operations specifications. VFR and DVFR flight operations are prohibited for any aircraft requiring an FAA routing authorization. (See paragraph 5-6-11 for FAA routing authorization information).

b. Civil aircraft registered in the U.S., Canada, or Mexico with a maximum certificated takeoff gross weight of 100,309 pounds (45,500 kgs) or less that are

operating without an operational transponder, and/or the ability to maintain two-way radio communications with ATC, are authorized to operate to or from U.S. territorial airspace over Alaska if in compliance with all of the following conditions:

1. Depart and land at an airport within the U.S. or Canada;
2. Enter or exit U.S. territorial airspace over Alaska north of the fifty-fourth parallel;
3. File and are on an active flight plan;
4. Comply with all other applicable ADIZ requirements described in paragraph 5-6-4 and any other national security requirements in paragraph 5-6-2;
5. Squawk 1200 if VFR and equipped with a transponder; and
6. Comply with all applicable U.S. CBP requirements, including Advance Passenger Information System (APIS) requirements (see subparagraph 5-6-5c below for CBP APIS information), in accordance with 19 CFR Part 122, *Air Commerce Regulations*.

c. CBP APIS Information. Information about U.S. CBP APIS requirements is available at <http://www.cbp.gov>.

5-6-6. Civil Aircraft Operations Within U.S. Territorial Airspace

a. Civil aircraft with a maximum certificated takeoff gross weight less than or equal to 100,309 pounds (45,500 kgs) are authorized to operate within U.S. territorial airspace in accordance with all applicable regulations and VFR in airport traffic pattern areas of U.S. airports near the U.S. border, except for those described in subparagraph 5-6-6b below.

b. Civil aircraft with a maximum certificated takeoff gross weight less than or equal to 100,309 pounds (45,500 kgs) and registered in a U.S. State Department-designated special interest country or operating with the ICAO 3LD of a company in a country listed as a U.S. State Department-designated special interest country, unless the operator holds valid FAA Part 129 operations specifications, must operate within U.S. territorial airspace in accordance with the same requirements as civil aircraft with a

maximum certificated takeoff gross weight greater than 100,309 pounds (45,500 kgs), as described in subparagraph 5-6-6c below.

c. Civil aircraft with a maximum certificated takeoff gross weight greater than 100,309 pounds (45,500 kgs) are authorized to operate within U.S. territorial airspace if in compliance with all of the following conditions:

1. File and are on an active flight plan (IFR or VFR);
2. Equipped with an operational transponder with altitude reporting capability, and continuously squawk an ATC assigned transponder code;
3. Maintain two-way radio communications with ATC;
4. Aircraft not registered in the U.S. must operate under an approved Transportation Security Administration (TSA) aviation security program (see paragraph 5-6-10 for TSA aviation security program information) or in accordance with an FAA/TSA airspace waiver (see paragraph 5-6-9 for FAA/TSA airspace waiver information), except as authorized in 5-6-6c6. below;

5. Are in receipt of, and are operating in accordance with an FAA routing authorization and an FAA/TSA airspace waiver if the aircraft is registered in a U.S. State Department-designated special interest country or is operating with the ICAO 3LD of a company in a country listed as a U.S. State Department-designated special interest country, unless the operator holds valid FAA Part 129 operations specifications. VFR and DVFR flight operations are prohibited for any aircraft requiring an FAA routing authorization. (See paragraph 5-6-11 for FAA routing authorization information.); and

6. Aircraft not registered in the U.S., when conducting post-maintenance, manufacturer, production, or acceptance flight test operations, are exempt from the requirements in 5-6-6c4 above if all of the following requirements are met:

- (a) A U.S. company must have operational control of the aircraft;
- (b) An FAA-certificated pilot must serve as pilot in command;
- (c) Only crewmembers are permitted onboard the aircraft; and
- (d) "Maintenance Flight" is included in the remarks section of the flight plan.

5-6-7. Civil Aircraft Operations Transiting U.S. Territorial Airspace

a. Civil aircraft (except those operating in accordance with subparagraphs 5-6-7b, 5-6-7c, 5-6-7d, and 5-6-7e) are authorized to transit U.S. territorial airspace if in compliance with all of the following conditions:

1. File and are on an active flight plan (IFR, VFR, or DVFR);

2. Equipped with an operational transponder with altitude reporting capability and continuously squawk an ATC assigned transponder code;

3. Maintain two-way radio communications with ATC;

4. Comply with all other applicable ADIZ requirements described in paragraph 5-6-4 and any other national security requirements in paragraph 5-6-2;

5. Are operating under an approved TSA aviation security program (see paragraph 5-6-10 for TSA aviation security program information) or are operating with and in accordance with an FAA/TSA airspace waiver (see paragraph 5-6-9 for FAA/TSA airspace waiver information), if:

(a) The aircraft is not registered in the U.S.; or

(b) The aircraft is registered in the U.S. and its maximum takeoff gross weight is greater than 100,309 pounds (45,500 kgs);

6. Are in receipt of, and are operating in accordance with, an FAA routing authorization if the aircraft is registered in a U.S. State Department-designated special interest country or is operating with the ICAO 3LD of a company in a country listed as a U.S. State Department-designated special interest country, unless the operator holds valid FAA Part 129 operations specifications. VFR and DVFR flight operations are prohibited for any aircraft requiring an FAA routing authorization. (See paragraph 5-6-11 for FAA routing authorization information.)

b. Civil aircraft registered in Canada or Mexico, and engaged in operations for the purposes of air ambulance, firefighting, law enforcement, search and rescue, or emergency evacuation are authorized to transit U.S. territorial airspace within 50 NM of their respective borders with the U.S., with or without an active flight plan, provided they have received and

continuously transmit an ATC-assigned transponder code.

c. Civil aircraft registered in Canada, Mexico, Bahamas, Bermuda, Cayman Islands, or the British Virgin Islands with a maximum certificated takeoff gross weight of 100,309 pounds (45,500 kgs) or less are authorized to transit U.S. territorial airspace if in compliance with all of the following conditions:

1. File and are on an active flight plan (IFR, VFR, or DVFR) that enters U.S. territorial airspace directly from any of the countries listed in this subparagraph 5-6-7c. Flights that include a stop in a non-listed country prior to entering U.S. territorial airspace must comply with the requirements prescribed by subparagraph 5-6-7a above, including operating under an approved TSA aviation security program (see paragraph 5-6-10 for TSA aviation program information) or operating with, and in accordance with, an FAA/TSA airspace waiver (see paragraph 5-6-9 for FAA/TSA airspace waiver information).

2. Equipped with an operational transponder with altitude reporting capability and continuously squawk an ATC assigned transponder code; and

3. Maintain two-way radio communications with ATC.

4. Comply with all other applicable ADIZ requirements described in paragraph 5-6-4 and any other national security requirements in paragraph 5-6-2.

d. Civil aircraft registered in Canada, Mexico, Bahamas, Bermuda, Cayman Islands, or the British Virgin Islands with a maximum certificated takeoff gross weight greater than 100,309 pounds (45,500 kgs) must comply with the requirements subparagraph 5-6-7a, including operating under an approved TSA aviation security program (see paragraph 5-6-10 for TSA aviation program information) or operating with, and in accordance with, an FAA/TSA airspace waiver (see paragraph 5-6-9 for FAA/TSA airspace waiver information).

e. Civil aircraft registered in the U.S., Canada, or Mexico with a maximum certificated takeoff gross weight of 100,309 pounds (45,500 kgs) or less that are operating without an operational transponder and/or the ability to maintain two-way radio communications with ATC, are authorized to transit U.S. territorial airspace over Alaska if in compliance with all of the following conditions:

1. Enter and exit U.S. territorial airspace over Alaska north of the fifty-fourth parallel;
2. File and are on an active flight plan;
3. Squawk 1200 if VFR and equipped with a transponder.
4. Comply with all other applicable ADIZ requirements described in paragraph 5-6-4 and any other national security requirements in paragraph 5-6-2.

5-6-8. Foreign State Aircraft Operations

a. Foreign state aircraft are authorized to operate in U.S. territorial airspace if in compliance with all of the following conditions:

1. File and are on an active IFR flight plan;
2. Equipped with an operational transponder with altitude reporting capability and continuously squawk an ATC assigned transponder code;
3. Maintain two-way radio communications with ATC;
4. Comply with all other applicable ADIZ requirements described in paragraph 5-6-4 and any other national security requirements in paragraph 5-6-2.

b. Diplomatic Clearances. Foreign state aircraft may operate to or from, within, or in transit of U.S. territorial airspace only when authorized by the U.S. State Department by means of a diplomatic clearance, except as described in subparagraph 5-6-8h below.

1. Information about diplomatic clearances is available at the U.S. State Department website <http://www.state.gov/t/pm/iso/c56895.htm> (lower case only).

2. A diplomatic clearance may be initiated by contacting the U.S. State Department via email at DCAS@state.gov or via phone at (202) 663-3390.

NOTE-

A diplomatic clearance is not required for foreign state aircraft operations that transit U.S. controlled oceanic airspace but do not enter U.S. territorial airspace. (See subparagraph 5-6-8d for flight plan information.)

c. An FAA routing authorization for state aircraft operations of special interest countries listed in subparagraph 5-6-11b. is required before the U.S.

State Department will issue a diplomatic clearance for such operations. (See subparagraph 5-6-11 for FAA routing authorizations information).

d. Foreign state aircraft operating with a diplomatic clearance must navigate U.S. territorial airspace on an active IFR flight plan, unless specifically approved for VFR flight operations by the U.S. State Department in the diplomatic clearance.

NOTE-

Foreign state aircraft operations to or from, within, or transiting U.S. territorial airspace; or transiting any U.S. controlled oceanic airspace, should enter ICAO code M in Item 8 of the flight plan to assist in identification of the aircraft as a state aircraft.

e. A foreign aircraft that operates to or from, within, or in transit of U.S. territorial airspace while conducting a state aircraft operation is not authorized to change its status as a state aircraft during any portion of the approved, diplomatically cleared itinerary.

f. A foreign aircraft described in subparagraph 5-6-8e above may operate from or within U.S. territorial airspace as a civil aircraft operation, once it has completed its approved, diplomatically cleared itinerary, if the aircraft operator is:

1. A foreign air carrier that holds valid FAA Part 129 operations specifications; and

2. Is in compliance with all other requirements applied to foreign civil aircraft operations from or within U.S. territorial airspace. (See paragraphs 5-6-5 and 5-6-6.)

g. Foreign state aircraft operations are not authorized to or from Ronald Reagan Washington National Airport (KDCA).

h. Diplomatic Clearance Exceptions. State aircraft operations on behalf of the governments of Canada and Mexico conducted for the purposes of air ambulance, firefighting, law enforcement, search and rescue, or emergency evacuation are authorized to transit U.S. territorial airspace within 50 NM of their respective borders with the U.S., with or without an active flight plan, provided they have received and continuously transmit an ATC assigned transponder code. State aircraft operations on behalf of the governments of Canada and Mexico conducted under this subparagraph 5-6-8h are not required to obtain a diplomatic clearance from the U.S. State Department.

5-6-9. FAA/TSA Airspace Waivers

a. Operators may submit requests for FAA/TSA airspace waivers at <https://waivers.faa.gov> by selecting “international” as the waiver type.

b. Information regarding FAA/TSA airspace waivers can be found at: <http://www.tsa.gov/for-industry/general-aviation> or can be obtained by contacting TSA at (571) 227-2071.

c. All existing FAA/TSA waivers issued under previous FDC NOTAMS remain valid until the expiration date specified in the waiver, unless sooner superseded or rescinded.

5-6-10. TSA Aviation Security Programs

a. Applicants for U.S. air operator certificates will be provided contact information for TSA aviation security programs by the U.S. Department of Transportation during the certification process.

b. For information about applicable TSA security programs:

1. U.S. air carriers and commercial operators must contact their TSA Principal Security Specialist (PSS); and

2. Foreign air carriers must contact their International Industry Representative (IIR).

5-6-11. FAA Flight Routing Authorizations

a. Information about FAA routing authorizations for U.S. State Department-designated special interest country flight operations to or from, within, or transiting U.S. territorial airspace is available by country at:

1. FAA website http://www.faa.gov/air_traffic/publications/us_restrictions/; or

2. Phone by contacting the FAA System Operations Support Center (SOSC) at (202) 267-8115.

b. Special Interest Countries. The U.S. State Department-designated special interest countries are

Cuba, Iran, The Democratic People’s Republic of Korea (North Korea), The People’s Republic of China, The Russian Federation, Sudan, and Syria.

NOTE-

FAA flight routing authorizations are not required for aircraft registered in Hong Kong, Taiwan, or Macau.

c. Aircraft operating with the ICAO 3LD assigned to a company or entity from a country listed as a State Department-designated special interest country and holding valid FAA Part 129 operations specifications do not require FAA flight routing authorization.

d. FAA routing authorizations will only be granted for IFR operations. VFR and DVFR flight operations are prohibited for any aircraft requiring an FAA routing authorization.

5-6-12. Emergency Security Control of Air Traffic (ESCAT)

a. During defense emergency or air defense emergency conditions, additional special security instructions may be issued in accordance with 32 CFR Part 245, *Plan for the Emergency Security Control of Air Traffic (ESCAT)*.

b. Under the provisions of 32 CFR Part 245, the military will direct the action to be taken in regard to landing, grounding, diversion, or dispersal of aircraft in the defense of the U.S. during emergency conditions.

c. At the time a portion or all of ESCAT is implemented, ATC facilities will broadcast appropriate instructions received from the Air Traffic Control System Command Center (ATCSCC) over available ATC frequencies. Depending on instructions received from the ATCSCC, VFR flights may be directed to land at the nearest available airport, and IFR flights will be expected to proceed as directed by ATC.

d. Pilots on the ground may be required to file a flight plan and obtain an approval (through FAA) prior to conducting flight operation.

5–6–13. Interception Procedures

a. General.

1. In conjunction with the FAA, Air Defense Sectors monitor air traffic and could order an intercept in the interest of national security or defense. Intercepts during peacetime operations are vastly different than those conducted under increased states of readiness. The interceptors may be fighters or rotary wing aircraft. The reasons for aircraft intercept include, but are not limited to:

- (a) Identify an aircraft;
- (b) Track an aircraft;
- (c) Inspect an aircraft;
- (d) Divert an aircraft;
- (e) Establish communications with an aircraft.

2. When specific information is required (i.e., markings, serial numbers, etc.) the interceptor pilot(s) will respond only if, in their judgment, the request can be conducted in a safe manner. Intercept procedures are described in some detail in the paragraphs below. In all situations, the interceptor pilot will consider safety of flight for all concerned throughout the intercept procedure. The interceptor pilot(s) will use caution to avoid startling the intercepted crew or passengers and understand that maneuvers considered normal for interceptor aircraft may be considered hazardous to other aircraft.

3. All aircraft operating in US national airspace are highly encouraged to maintain a listening watch on VHF/UHF guard frequencies (121.5 or 243.0 MHz). If subjected to a military intercept, it is incumbent on civilian aviators to understand their responsibilities and to comply with ICAO standard signals relayed from the intercepting aircraft. Specifically, aviators are expected to contact air traffic control without delay (if able) on the local operating frequency or on VHF/UHF guard. Noncompliance may result in the use of force.

b. Fighter intercept phases (See FIG 5–6–1).

1. Approach Phase.

As standard procedure, intercepted aircraft are approached from behind. Typically, interceptor aircraft will be employed in pairs, however, it is not uncommon for a single aircraft to perform the

intercept operation. Safe separation between interceptors and intercepted aircraft is the responsibility of the intercepting aircraft and will be maintained at all times.

2. Identification Phase.

Interceptor aircraft will initiate a controlled closure toward the aircraft of interest, holding at a distance no closer than deemed necessary to establish positive identification and to gather the necessary information. The interceptor may also fly past the intercepted aircraft while gathering data at a distance considered safe based on aircraft performance characteristics.

3. Post Intercept Phase.

An interceptor may attempt to establish communications via standard ICAO signals. In time-critical situations where the interceptor is seeking an immediate response from the intercepted aircraft or if the intercepted aircraft remains non-compliant to instruction, the interceptor pilot may initiate a divert maneuver. In this maneuver, the interceptor flies across the intercepted aircraft's flight path (minimum 500 feet separation and commencing from slightly below the intercepted aircraft altitude) in the general direction the intercepted aircraft is expected to turn. The interceptor will rock its wings (daytime) or flash external lights/select afterburners (night) while crossing the intercepted aircraft's flight path. The interceptor will roll out in the direction the intercepted aircraft is expected to turn before returning to verify the aircraft of interest is complying. The intercepted aircraft is expected to execute an immediate turn to the direction of the intercepting aircraft. If the aircraft of interest does not comply, the interceptor may conduct a second climbing turn across the intercepted aircraft's flight path (minimum 500 feet separation and commencing from slightly below the intercepted aircraft altitude) while expending flares as a warning signal to the intercepted aircraft to comply immediately and to turn in the direction indicated and to leave the area. The interceptor is responsible to maintain safe separation during these and all intercept maneuvers. Flight safety is paramount.

NOTE–

1. *NORAD interceptors will take every precaution to preclude the possibility of the intercepted aircraft experiencing jet wash/wake turbulence; however, there is a potential that this condition could be encountered.*

2. *During Night/IMC, the intercept will be from below flight path.*

FIG 5-6-1
Intercept Procedures

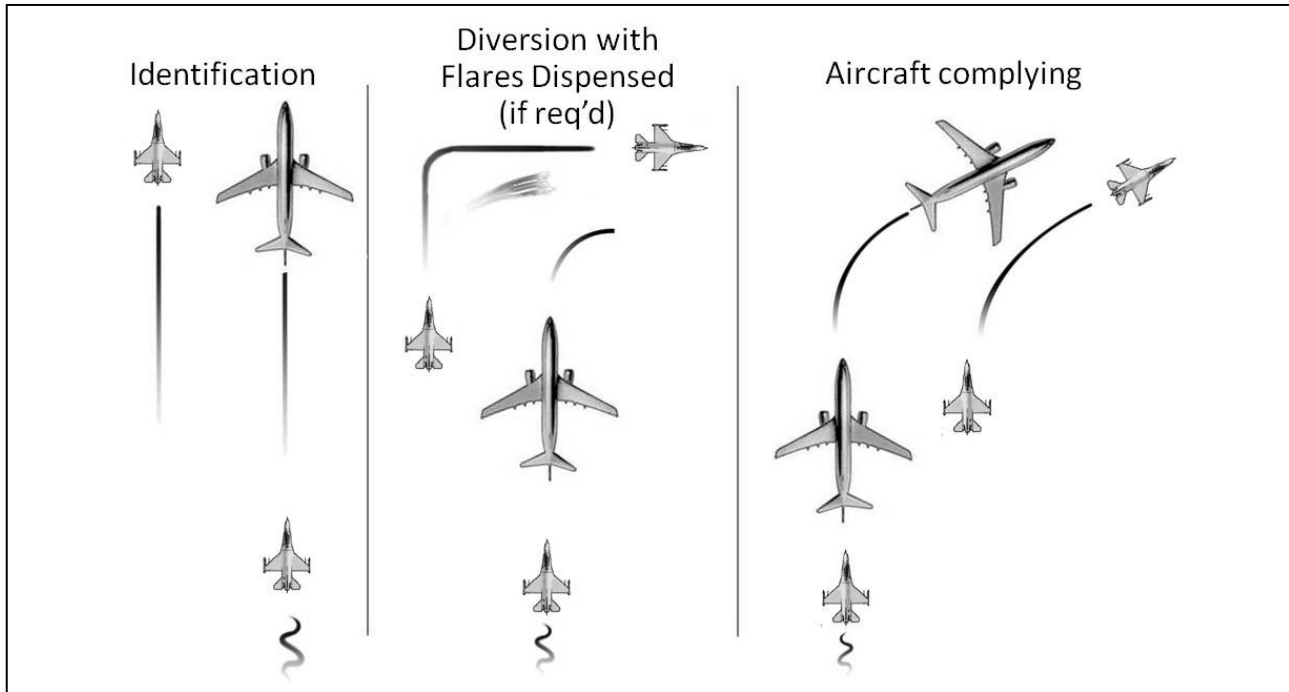

c. Helicopter Intercept phases (See FIG 5-6-2)

1. Approach Phase.

Aircraft intercepted by helicopter may be approached from any direction, although the helicopter should close for identification and signaling from behind. Generally, the helicopter will approach off the left side of the intercepted aircraft. Safe separation between the helicopter and the unidentified aircraft will be maintained at all times.

2. Identification Phase.

The helicopter will initiate a controlled closure toward the aircraft of interest, holding at a distance no closer than deemed necessary to establish positive identification and gather the necessary information. The intercepted pilot should expect the interceptor helicopter to take a position off his left wing slightly forward of abeam.

3. Post Intercept Phase.

Visual signaling devices may be used in an attempt to communicate with the intercepted aircraft. Visual signaling devices may include, but are not limited to, LED scrolling signboards or blue flashing lights. If compliance is not attained through the use of radios or signaling devices, standard ICAO intercept signals (Table 5-6-1) may be employed. In order to maintain safe aircraft separation, it is incumbent upon the pilot of the intercepted aircraft not to fall into a trail position (directly behind the helicopter) if instructed to follow the helicopter. This is because the helicopter pilot may lose visual contact with the intercepted aircraft.

NOTE-

Intercepted aircraft must not follow directly behind the helicopter thereby allowing the helicopter pilot to maintain visual contact with the intercepted aircraft and ensuring safe separation is maintained.

FIG 5-6-2
Helicopter Intercept Procedures

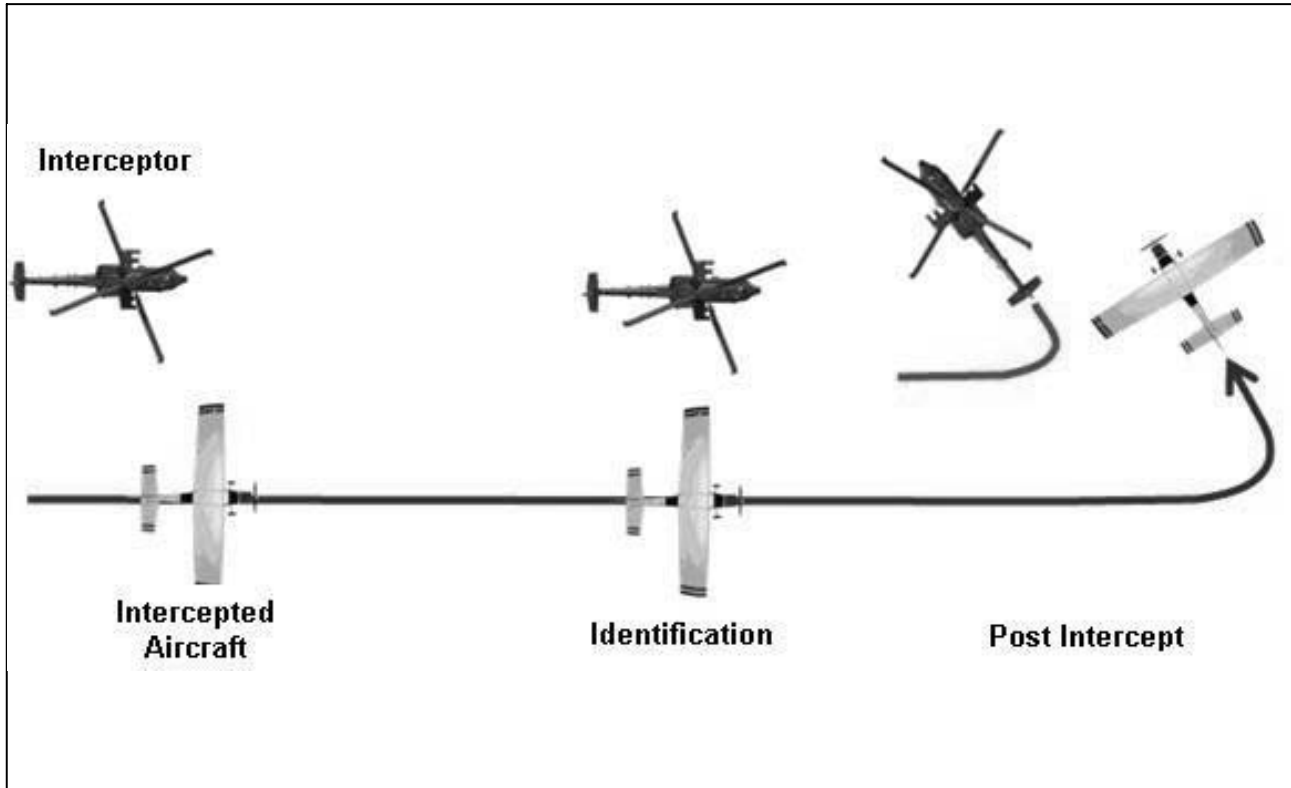

d. Summary of Intercepted Aircraft Actions. An intercepted aircraft must, without delay:

1. Adhere to instructions relayed through the use of visual devices, visual signals, and radio communications from the intercepting aircraft.
2. Attempt to establish radio communications with the intercepting aircraft or with the appropriate air traffic control facility by making a general call on guard frequencies (121.5 or 243.0 MHz), giving the identity, position, and nature of the flight.
3. If transponder equipped, select Mode 3/A Code 7700 unless otherwise instructed by air traffic control.

NOTE-

If instruction received from any agency conflicts with that given by the intercepting aircraft through visual or radio communications, the intercepted aircraft must seek immediate clarification.

4. The crew of the intercepted aircraft must continue to comply with interceptor aircraft signals and instructions until positively released.

5-6-14. Law Enforcement Operations by Civil and Military Organizations

a. Special law enforcement operations.

1. Special law enforcement operations include in-flight identification, surveillance, interdiction, and pursuit activities performed in accordance with official civil and/or military mission responsibilities.
2. To facilitate accomplishment of these special missions, exemptions from specified sections of the CFRs have been granted to designated departments and agencies. However, it is each organization’s responsibility to apprise ATC of their intent to operate under an authorized exemption before initiating actual operations.
3. Additionally, some departments and agencies that perform special missions have been assigned coded identifiers to permit them to apprise ATC of ongoing mission activities and solicit special air traffic assistance.

5-6-15. Interception Signals

TBL 5-6-1 and TBL 5-6-2.

TBL 5-6-1
Intercepting Signals

INTERCEPTING SIGNALS				
Signals initiated by intercepting aircraft and responses by intercepted aircraft (as set forth in ICAO Annex 2-Appendix 1, 2.1)				
Series	INTERCEPTING Aircraft Signals	Meaning	INTERCEPTED Aircraft Responds	Meaning
1	<p>DAY-Rocking wings from a position slightly above and ahead of, and normally to the left of, the intercepted aircraft and, after acknowledgement, a slow level turn, normally to the left, on to the desired heading.</p> <p>NIGHT-Same and, in addition, flashing navigational lights at irregular intervals.</p> <p><i>NOTE 1-Meteorological conditions or terrain may require the intercepting aircraft to take up a position slightly above and ahead of, and to the right of, the intercepted aircraft and to make the subsequent turn to the right.</i></p> <p><i>NOTE 2-If the intercepted aircraft is not able to keep pace with the intercepting aircraft, the latter is expected to fly a series of race-track patterns and to rock its wings each time it passes the intercepted aircraft.</i></p>	<p>You have been intercepted. Follow me.</p>	<p>AEROPLANES: DAY-Rocking wings and following.</p> <p>NIGHT-Same and, in addition, flashing navigational lights at irregular intervals.</p> <p>HELICOPTERS: DAY or NIGHT-Rocking aircraft, flashing navigational lights at irregular intervals and following.</p>	<p>Understood, will comply.</p>
2	<p>DAY or NIGHT-An abrupt break-away maneuver from the intercepted aircraft consisting of a climbing turn of 90 degrees or more without crossing the line of flight of the intercepted aircraft.</p>	<p>You may proceed.</p>	<p>AEROPLANES: DAY or NIGHT-Rocking wings.</p> <p>HELICOPTERS: DAY or NIGHT-Rocking aircraft.</p>	<p>Understood, will comply.</p>
3	<p>DAY-Circling aerodrome, lowering landing gear and overflying runway in direction of landing or, if the intercepted aircraft is a helicopter, overflying the helicopter landing area.</p> <p>NIGHT-Same and, in addition, showing steady landing lights.</p>	<p>Land at this aerodrome.</p>	<p>AEROPLANES: DAY-Lowering landing gear, following the intercepting aircraft and, if after overflying the runway landing is considered safe, proceeding to land.</p> <p>NIGHT-Same and, in addition, showing steady landing lights (if carried).</p> <p>HELICOPTERS: DAY or NIGHT-Following the intercepting aircraft and proceeding to land, showing a steady landing light (if carried).</p>	<p>Understood, will comply.</p>

TBL 5-6-2
Intercepting Signals

INTERCEPTING SIGNALS				
Signals and Responses During Aircraft Intercept				
Signals initiated by intercepted aircraft and responses by intercepting aircraft				
(as set forth in ICAO Annex 2-Appendix 1, 2.2)				
Series	INTERCEPTED Aircraft Signals	Meaning	INTERCEPTING Aircraft Responds	Meaning
4	DAY or NIGHT-Raising landing gear (if fitted) and flashing landing lights while passing over runway in use or helicopter landing area at a height exceeding 300m (1,000 ft) but not exceeding 600m (2,000 ft) (in the case of a helicopter, at a height exceeding 50m (170 ft) but not exceeding 100m (330 ft) above the aerodrome level, and continuing to circle runway in use or helicopter landing area. If unable to flash landing lights, flash any other lights available.	Aerodrome you have designated is inadequate.	DAY or NIGHT-If it is desired that the intercepted aircraft follow the intercepting aircraft to an alternate aerodrome, the intercepting aircraft raises its landing gear (if fitted) and uses the Series 1 signals prescribed for intercepting aircraft. If it is decided to release the intercepted aircraft, the intercepting aircraft uses the Series 2 signals prescribed for intercepting aircraft.	Understood, follow me. Understood, you may proceed.
5	DAY or NIGHT-Regular switching on and off of all available lights but in such a manner as to be distinct from flashing lights.	Cannot comply.	DAY or NIGHT-Use Series 2 signals prescribed for intercepting aircraft.	Understood.
6	DAY or NIGHT-Irregular flashing of all available lights.	In distress.	DAY or NIGHT-Use Series 2 signals prescribed for intercepting aircraft.	Understood.

5-6-16. ADIZ Boundaries and Designated Mountainous Areas (See FIG 5-6-3.)

FIG 5-6-3
Air Defense Identification Zone Boundaries
Designated Mountainous Areas

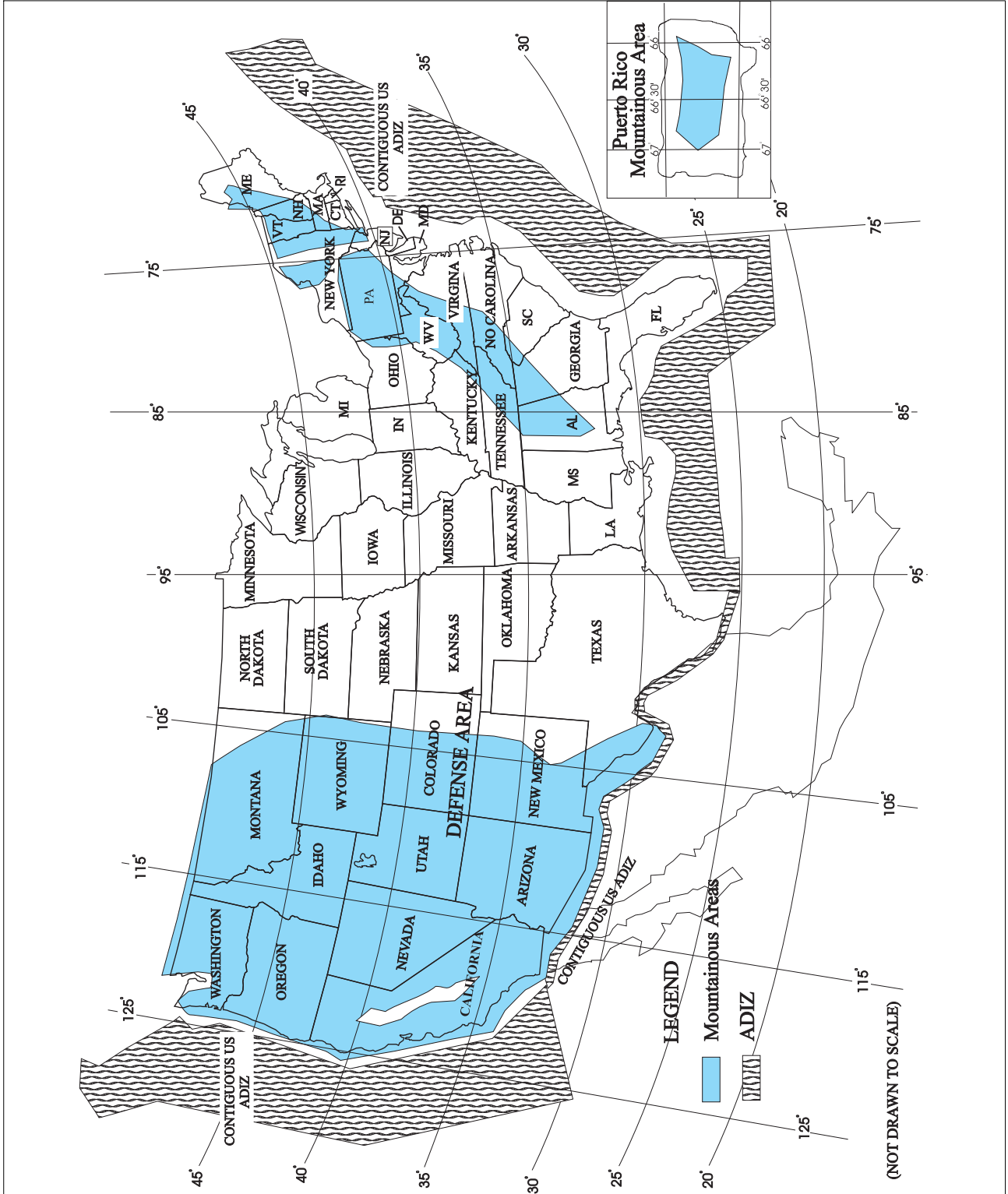

5-6-17. Visual Warning System (VWS)

The VWS signal consists of highly-focused red and green colored laser lights designed to illuminate in an alternating red and green signal pattern. These lasers may be directed at specific aircraft suspected of making unauthorized entry into the Washington, DC Special Flight Rules Area (DC SFRA) proceeding on a heading or flight path that may be interpreted as a threat or that operate contrary to the operating rules for the DC SFRA. The beam is neither hazardous to the eyes of pilots/aircrew or passengers, regardless of altitude or distance from the source nor will the beam affect aircraft systems.

a. If you are communicating with ATC, and this signal is directed at your aircraft, you are required to contact ATC and advise that you are being illuminated by a visual warning system.

b. If this signal is directed at you, and you are not communicating with ATC, you are advised to turn to the most direct heading away from the center of the DC SFRA as soon as possible. Immediately contact

ATC on an appropriate frequency, VHF Guard 121.5 or UHF Guard 243.0, and provide your aircraft identification, position, and nature of the flight. Failure to follow these procedures may result in interception by military aircraft. Further noncompliance with interceptor aircraft or ATC may result in the use of force.

c. Pilots planning to operate aircraft in or near the DC SFRA are to familiarize themselves with aircraft intercept procedures. This information applies to all aircraft operating within the DC SFRA including DOD, Law Enforcement, and aircraft engaged in aeromedical operations and does not change procedures established for reporting unauthorized laser illumination as published in FAA Advisory Circulars and Notices.

REFERENCE-
CFR 91.161

d. More details including a video demonstration of the VWS are available from the following FAA website: www.faa.gov/VisualWarningSystem/VisualWarning.htm.

Chapter 6. Emergency Procedures

Section 1. General

6-1-1. Pilot Responsibility and Authority

a. The pilot-in-command of an aircraft is directly responsible for and is the final authority as to the operation of that aircraft. In an emergency requiring immediate action, the pilot-in-command may deviate from any rule in 14 CFR Part 91, Subpart A, General, and Subpart B, Flight Rules, to the extent required to meet that emergency.

REFERENCE-
14 CFR Section 91.3(b).

b. If the emergency authority of 14 CFR Section 91.3(b) is used to deviate from the provisions of an ATC clearance, the pilot-in-command must notify ATC as soon as possible and obtain an amended clearance.

c. Unless deviation is necessary under the emergency authority of 14 CFR Section 91.3, pilots of IFR flights experiencing two-way radio communications failure are expected to adhere to the procedures prescribed under “IFR operations, two-way radio communications failure.”

REFERENCE-
14 CFR Section 91.185.

6-1-2. Emergency Condition- Request Assistance Immediately

a. An emergency can be either a *distress* or *urgency* condition as defined in the Pilot/Controller Glossary. Pilots do not hesitate to declare an emergency when they are faced with *distress* conditions such as fire, mechanical failure, or structural damage. However, some are reluctant to report an *urgency* condition when they encounter situations which may not be immediately perilous, but are potentially catastrophic. An aircraft is in at least an *urgency* condition the moment the pilot becomes doubtful about position, fuel endurance, weather, or any other condition that could adversely affect flight safety. This is the time to ask for help, not after the situation has developed into a *distress* condition.

b. Pilots who become apprehensive for their safety for any reason should *request assistance immediately*. Ready and willing help is available in the form of radio, radar, direction finding stations and other aircraft. Delay has caused accidents and cost lives. *Safety is not a luxury! Take action!*

Section 2. Emergency Services Available to Pilots

6-2-1. Radar Service for VFR Aircraft in Difficulty

a. Radar equipped ATC facilities can provide radar assistance and navigation service (vectors) to VFR aircraft in difficulty when the pilot can talk with the controller, and the aircraft is within radar coverage. Pilots should clearly understand that authorization to proceed in accordance with such radar navigational assistance does not constitute authorization for the pilot to violate CFRs. In effect, assistance is provided on the basis that navigational guidance information is advisory in nature, and the responsibility for flying the aircraft safely remains with the pilot.

b. Experience has shown that many pilots who are not qualified for instrument flight cannot maintain control of their aircraft when they encounter clouds or other reduced visibility conditions. In many cases, the controller will not know whether flight into instrument conditions will result from ATC instructions. To avoid possible hazards resulting from being vectored into IFR conditions, a pilot in difficulty should keep the controller advised of the current weather conditions being encountered and the weather along the course ahead and observe the following:

1. If a course of action is available which will permit flight and a safe landing in VFR weather conditions, noninstrument rated pilots should choose the VFR condition rather than requesting a vector or approach that will take them into IFR weather conditions; or

2. If continued flight in VFR conditions is not possible, the noninstrument rated pilot should so advise the controller and indicating the lack of an instrument rating, declare a *distress* condition; or

3. If the pilot is instrument rated and current, and the aircraft is instrument equipped, the pilot should so indicate by requesting an IFR flight clearance. Assistance will then be provided on the basis that the aircraft can operate safely in IFR weather conditions.

6-2-2. Transponder Emergency Operation

a. When a *distress* or *urgency* condition is encountered, the pilot of an aircraft with a coded radar beacon transponder, who desires to alert a ground radar facility, should squawk Mode 3/A, Code 7700/Emergency and Mode C altitude reporting and then immediately establish communications with the ATC facility.

b. Radar facilities are equipped so that Code 7700 normally triggers an alarm or special indicator at all control positions. Pilots should understand that they might not be within a radar coverage area. Therefore, they should continue squawking Code 7700 and establish radio communications as soon as possible.

6-2-3. Intercept and Escort

a. The concept of airborne intercept and escort is based on the Search and Rescue (SAR) aircraft establishing visual and/or electronic contact with an aircraft in difficulty, providing in-flight assistance, and escorting it to a safe landing. If bailout, crash landing or ditching becomes necessary, SAR operations can be conducted without delay. For most incidents, particularly those occurring at night and/or during instrument flight conditions, the availability of intercept and escort services will depend on the proximity of SAR units with suitable aircraft on alert for immediate dispatch. In limited circumstances, other aircraft flying in the vicinity of an aircraft in difficulty can provide these services.

b. If specifically requested by a pilot in difficulty or if a *distress* condition is declared, SAR coordinators *will* take steps to intercept and escort an aircraft. Steps may be initiated for intercept and escort if an *urgency* condition is declared and unusual circumstances make such action advisable.

c. It is the pilot's prerogative to refuse intercept and escort services. Escort services will normally be provided to the nearest adequate airport. Should the pilot receiving escort services continue onto another location after reaching a safe airport, or decide not to divert to the nearest safe airport, the escort aircraft is not obligated to continue and further escort is

discretionary. The decision will depend on the circumstances of the individual incident.

6-2-4. Emergency Locator Transmitter (ELT)

a. General.

1. ELTs are required for most General Aviation airplanes.

*REFERENCE—
14 CFR SECTION 91.207.*

2. ELTs of various types were developed as a means of locating downed aircraft. These electronic, battery operated transmitters operate on one of three frequencies. These operating frequencies are 121.5 MHz, 243.0 MHz, and the newer 406 MHz. ELTs operating on 121.5 MHz and 243.0 MHz are analog devices. The newer 406 MHz ELT is a digital transmitter that can be encoded with the owner's contact information or aircraft data. The latest 406 MHz ELT models can also be encoded with the aircraft's position data which can help SAR forces locate the aircraft much more quickly after a crash. The 406 MHz ELTs also transmits a stronger signal when activated than the older 121.5 MHz ELTs.

(a) The Federal Communications Commission (FCC) requires 406 MHz ELTs be registered with the National Oceanic and Atmospheric Administration (NOAA) as outlined in the ELTs documentation. The FAA's 406 MHz ELT Technical Standard Order (TSO) TSO-C126 also requires that each 406 MHz ELT be registered with NOAA. The reason is NOAA maintains the owner registration database for U.S. registered 406 MHz alerting devices, which includes ELTs. NOAA also operates the United States' portion of the Cospas-Sarsat satellite distress alerting system designed to detect activated ELTs and other distress alerting devices.

(b) In the event that a properly registered 406 MHz ELT activates, the Cospas-Sarsat satellite system can decode the owner's information and provide that data to the appropriate search and rescue (SAR) center. In the United States, NOAA provides the alert data to the appropriate U.S. Air Force Rescue Coordination Center (RCC) or U.S. Coast Guard Rescue Coordination Center. That RCC can then telephone or contact the owner to verify the status of the aircraft. If the aircraft is safely secured in a hangar, a costly ground or airborne search is

avoided. In the case of an inadvertent 406 MHz ELT activation, the owner can deactivate the 406 MHz ELT. If the 406 MHz ELT equipped aircraft is being flown, the RCC can quickly activate a search. 406 MHz ELTs permit the Cospas-Sarsat satellite system to narrow the search area to a more confined area compared to that of a 121.5 MHz or 243.0 MHz ELT. 406 MHz ELTs also include a low-power 121.5 MHz homing transmitter to aid searchers in finding the aircraft in the terminal search phase.

(c) Each analog ELT emits a distinctive downward swept audio tone on 121.5 MHz and 243.0 MHz.

(d) If "armed" and when subject to crash-generated forces, ELTs are designed to automatically activate and continuously emit their respective signals, analog or digital. The transmitters will operate continuously for at least 48 hours over a wide temperature range. A properly installed, maintained, and functioning ELT can expedite search and rescue operations and save lives if it survives the crash and is activated.

(e) Pilots and their passengers should know how to activate the aircraft's ELT if manual activation is required. They should also be able to verify the aircraft's ELT is functioning and transmitting an alert after a crash or manual activation.

(f) Because of the large number of 121.5 MHz ELT false alerts and the lack of a quick means of verifying the actual status of an activated 121.5 MHz or 243.0 MHz analog ELT through an owner registration database, U.S. SAR forces do not respond as quickly to initial 121.5/243.0 MHz ELT alerts as the SAR forces do to 406 MHz ELT alerts. Compared to the almost instantaneous detection of a 406 MHz ELT, SAR forces' normal practice is to wait for either a confirmation of a 121.5/243.0 MHz alert by additional satellite passes or through confirmation of an overdue aircraft or similar notification. In some cases, this confirmation process can take hours. SAR forces can initiate a response to 406 MHz alerts in minutes compared to the potential delay of hours for a 121.5/243.0 MHz ELT.

3. The Cospas-Sarsat system has announced the termination of satellite monitoring and reception of the 121.5 MHz and 243.0 MHz frequencies in 2009. The Cospas-Sarsat system will continue to monitor the 406 MHz frequency. What this means for pilots is that after the termination date, those aircraft with only

121.5 MHz or 243.0 MHz ELT's onboard will have to depend upon either a nearby Air Traffic Control facility receiving the alert signal or an overflying aircraft monitoring 121.5 MHz or 243.0 MHz detecting the alert. To ensure adequate monitoring of these frequencies and timely alerts after 2009, all airborne pilots should periodically monitor these frequencies to try and detect an activated 121.5/243.0 MHz ELT.

b. Testing.

1. ELTs should be tested in accordance with the manufacturer's instructions, preferably in a shielded or screened room or specially designed test container to prevent the broadcast of signals which could trigger a false alert.

2. When this cannot be done, aircraft operational testing is authorized as follows:

(a) Analog 121.5/243 MHz ELTs should only be tested during the first 5 minutes after any hour. If operational tests must be made outside of this period, they should be coordinated with the nearest FAA Control Tower. Tests should be no longer than three audible sweeps. If the antenna is removable, a dummy load should be substituted during test procedures.

(b) Digital 406 MHz ELTs should only be tested in accordance with the unit's manufacturer's instructions.

(c) Airborne tests are not authorized.

c. False Alarms.

1. Caution should be exercised to prevent the inadvertent activation of ELTs in the air or while they are being handled on the ground. Accidental or unauthorized activation will generate an emergency signal that cannot be distinguished from the real thing, leading to expensive and frustrating searches. A false ELT signal could also interfere with genuine emergency transmissions and hinder or prevent the timely location of crash sites. Frequent false alarms could also result in complacency and decrease the vigorous reaction that must be attached to all ELT signals.

2. Numerous cases of inadvertent activation have occurred as a result of aerobatics, hard landings, movement by ground crews and aircraft maintenance.

These false alarms can be minimized by monitoring 121.5 MHz and/or 243.0 MHz as follows:

(a) In flight when a receiver is available.

(b) Before engine shut down at the end of each flight.

(c) When the ELT is handled during installation or maintenance.

(d) When maintenance is being performed near the ELT.

(e) When a ground crew moves the aircraft.

(f) If an ELT signal is heard, turn off the aircraft's ELT to determine if it is transmitting. If it has been activated, maintenance might be required before the unit is returned to the "ARMED" position. You should contact the nearest Air Traffic facility and notify it of the inadvertent activation.

d. Inflight Monitoring and Reporting.

1. Pilots are encouraged to monitor 121.5 MHz and/or 243.0 MHz while inflight to assist in identifying possible emergency ELT transmissions. On receiving a signal, report the following information to the nearest air traffic facility:

(a) Your position at the time the signal was first heard.

(b) Your position at the time the signal was last heard.

(c) Your position at maximum signal strength.

(d) Your flight altitudes and frequency on which the emergency signal was heard: 121.5 MHz or 243.0 MHz. If possible, positions should be given relative to a navigation aid. If the aircraft has homing equipment, provide the bearing to the emergency signal with each reported position.

6-2-5. FAA K-9 Explosives Detection Team Program

a. The FAA's Office of Civil Aviation Security Operations manages the FAA K-9 Explosives Detection Team Program which was established in 1972. Through a unique agreement with law enforcement agencies and airport authorities, the FAA has strategically placed FAA-certified K-9 teams (a team is one handler and one dog) at airports throughout the country. If a bomb threat is received

while an aircraft is in flight, the aircraft can be directed to an airport with this capability. The FAA provides initial and refresher training for all handlers, provides single purpose explosive detector dogs, and requires that each team is annually evaluated in five areas for FAA certification: aircraft (widebody and narrowbody), vehicles, terminal, freight (cargo), and luggage. **If you desire this service, notify your company or an FAA air traffic control facility.**

b. The following list shows the locations of current FAA K-9 teams:

TBL 6-2-1
**FAA Sponsored Explosives Detection
 Dog/Handler Team Locations**

Airport Symbol	Location
ATL	Atlanta, Georgia
BHM	Birmingham, Alabama
BOS	Boston, Massachusetts
BUF	Buffalo, New York
CLT	Charlotte, North Carolina
ORD	Chicago, Illinois
CVG	Cincinnati, Ohio
DFW	Dallas, Texas
DEN	Denver, Colorado
DTW	Detroit, Michigan
IAH	Houston, Texas
JAX	Jacksonville, Florida
MCI	Kansas City, Missouri
LAX	Los Angeles, California
MEM	Memphis, Tennessee
MIA	Miami, Florida
MKE	Milwaukee, Wisconsin
MSY	New Orleans, Louisiana
MCO	Orlando, Florida
PHX	Phoenix, Arizona
PIT	Pittsburgh, Pennsylvania
PDX	Portland, Oregon
SLC	Salt Lake City, Utah
SFO	San Francisco, California
SJU	San Juan, Puerto Rico
SEA	Seattle, Washington

STL	St. Louis, Missouri
TUS	Tucson, Arizona
TUL	Tulsa, Oklahoma

c. If due to weather or other considerations an aircraft with a suspected hidden explosive problem were to land or intended to land at an airport other than those listed in b above, it is recommended that they call the FAA’s Washington Operations Center (telephone 202-267-3333, if appropriate) or have an air traffic facility with which you can communicate contact the above center requesting assistance.

6-2-6. Search and Rescue

a. General. SAR is a lifesaving service provided through the combined efforts of the federal agencies signatory to the National SAR Plan, and the agencies responsible for SAR within each state. Operational resources are provided by the U.S. Coast Guard, DOD components, the Civil Air Patrol, the Coast Guard Auxiliary, state, county and local law enforcement and other public safety agencies, and private volunteer organizations. Services include search for missing aircraft, survival aid, rescue, and emergency medical help for the occupants after an accident site is located.

b. National Search and Rescue Plan. By federal interagency agreement, the National Search and Rescue Plan provides for the effective use of all available facilities in all types of SAR missions. These facilities include aircraft, vessels, pararescue and ground rescue teams, and emergency radio fixing. Under the plan, the U.S. Coast Guard is responsible for the coordination of SAR in the Maritime Region, and the USAF is responsible in the Inland Region. To carry out these responsibilities, the Coast Guard and the Air Force have established Rescue Coordination Centers (RCCs) to direct SAR activities within their regions. For aircraft emergencies, distress, and urgency, information normally will be passed to the appropriate RCC through an ARTCC or FSS.

c. Coast Guard Rescue Coordination Centers. (See TBL 6-2-2.)

TBL 6-2-2

Coast Guard Rescue Coordination Centers

Coast Guard Rescue Coordination Centers	
Alameda, CA 510-437-3701	Miami, FL 305-415-6800
Boston, MA 617-223-8555	New Orleans, LA 504-589-6225
Cleveland, OH 216-902-6117	Portsmouth, VA 757-398-6390
Honolulu, HI 808-541-2500	Seattle, WA 206-220-7001
Juneau, AK 907-463-2000	San Juan, PR 787-289-2042

d. Air Force Rescue Coordination Centers.
(See TBL 6-2-3 and TBL 6-2-4.)

TBL 6-2-3

**Air Force Rescue Coordination Center
48 Contiguous States**

Air Force Rescue Coordination Center	
Tyndall AFB, Florida	Phone
Commercial	850-283-5955
WATS	800-851-3051
DSN	523-5955

TBL 6-2-4

**Air Command Rescue Coordination Center
Alaska**

Alaskan Air Command Rescue Coordination Center	
Elmendorf AFB, Alaska	Phone
Commercial	907-428-7230 800-420-7230 (outside Anchorage)
DSN	317-551-7230

e. Joint Rescue Coordination Center.
(See TBL 6-2-5.)

TBL 6-2-5

**Joint Rescue Coordination Center
Hawaii**

Honolulu Joint Rescue Coordination Center	
HQ 14th CG District Honolulu	Phone
Commercial	808-541-2500
DSN	448-0301

f. Emergency and Overdue Aircraft.

1. ARTCCs and FSSs will alert the SAR system when information is received from any source that an aircraft is in difficulty, overdue, or missing.

(a) Radar facilities providing radar flight following or advisories consider the loss of radar and radios, without service termination notice, to be a possible emergency. Pilots receiving VFR services from radar facilities should be aware that SAR may be initiated under these circumstances.

(b) A filed flight plan is the most timely and effective indicator that an aircraft is overdue. Flight plan information is invaluable to SAR forces for search planning and executing search efforts.

2. Prior to departure on every flight, local or otherwise, someone at the departure point should be advised of your destination and route of flight if other than direct. Search efforts are often wasted and rescue is often delayed because of pilots who thoughtlessly takeoff without telling anyone where they are going. File a flight plan for *your* safety.

3. According to the National Search and Rescue Plan, “The life expectancy of an injured survivor decreases as much as 80 percent during the first 24 hours, while the chances of survival of uninjured survivors rapidly diminishes after the first 3 days.”

4. An Air Force Review of 325 SAR missions conducted during a 23-month period revealed that “Time works against people who experience a *distress* but are not on a flight plan, since 36 hours normally pass before family concern initiates an (alert).”

g. VFR Search and Rescue Protection.

1. To receive this valuable protection, *file a VFR or DVFR Flight Plan* with an FAA FSS. For maximum protection, file only to the point of first intended landing, and refile for each leg to final destination. When a lengthy flight plan is filed, with several stops en route and an ETE to final destination, a mishap could occur on any leg, and unless other information is received, it is probable that no one would start looking for you until 30 minutes after your ETA at your final destination.

2. If you land at a location other than the intended destination, report the landing to the nearest FAA FSS and advise them of your original destination.

3. If you land en route and are delayed more than 30 minutes, report this information to the nearest FSS and give them your original destination.

4. If your ETE changes by 30 minutes or more, report a new ETA to the nearest FSS and give them your original destination. Remember that if you fail to respond within one-half hour after your ETA at final destination, a search will be started to locate you.

5. It is important that you *close your flight plan IMMEDIATELY AFTER ARRIVAL AT YOUR FINAL DESTINATION WITH THE FSS DESIGNATED WHEN YOUR FLIGHT PLAN WAS FILED. The pilot is responsible for closure of a VFR or DVFR flight plan; they are not closed automatically.* This will prevent needless search efforts.

6. The rapidity of rescue on land or water will depend on how accurately your position may be determined. If a flight plan has been followed and your position is on course, rescue will be expedited.

h. Survival Equipment.

1. For flight over uninhabited land areas, it is wise to take and know how to use survival equipment for the type of climate and terrain.

2. If a forced landing occurs at sea, chances for survival are governed by the degree of crew proficiency in emergency procedures and by the availability and effectiveness of water survival equipment.

i. Body Signal Illustrations.

1. If you are forced down and are able to attract the attention of the pilot of a rescue airplane, the body

signals illustrated on these pages can be used to transmit messages to the pilot circling over your location.

2. Stand in the open when you make the signals.

3. Be sure the background, as seen from the air, is not confusing.

4. Go through the motions slowly and repeat each signal until you are positive that the pilot understands you.

j. Observance of Downed Aircraft.

1. Determine if crash is marked with a yellow cross; if so, the crash has already been reported and identified.

2. If possible, determine type and number of aircraft and whether there is evidence of survivors.

3. Fix the position of the crash as accurately as possible with reference to a navigational aid. If possible, provide geographic or physical description of the area to aid ground search parties.

4. Transmit the information to the nearest FAA or other appropriate radio facility.

5. If circumstances permit, orbit the scene to guide in other assisting units until their arrival or until you are relieved by another aircraft.

6. Immediately after landing, make a complete report to the nearest FAA facility, or Air Force or Coast Guard Rescue Coordination Center. The report can be made by a long distance collect telephone call.

FIG 6-2-1
Ground-Air Visual Code for Use by Survivors

NO.	MESSAGE	CODE SYMBOL
1	Require assistance	V
2	Require medical assistance	X
3	No or Negative	N
4	Yes or Affirmative	Y
5	Proceeding in this direction	↑

IF IN DOUBT, USE INTERNATIONAL SYMBOL S O S

INSTRUCTIONS

1. Lay out symbols by using strips of fabric or parachutes, pieces of wood, stones, or any available material.
2. Provide as much color contrast as possible between material used for symbols and background against which symbols are exposed.
3. Symbols should be at least 10 feet high or larger. Care should be taken to lay out symbols exactly as shown.
4. In addition to using symbols, every effort is to be made to attract attention by means of radio, flares, smoke, or other available means.
5. On snow covered ground, signals can be made by dragging, shoveling or tramping. Depressed areas forming symbols will appear black from the air.
6. Pilot should acknowledge message by rocking wings from side to side.

FIG 6-2-2
Ground-Air Visual Code for use by Ground Search Parties

NO.	MESSAGE	CODE SYMBOL
1	Operation completed.	L L L
2	We have found all personnel.	L L
3	We have found only some personnel.	+ +
4	We are not able to continue. Returning to base.	X X
5	Have divided into two groups. Each proceeding in direction indicated.	↘ ↙
6	Information received that aircraft is in this direction.	→ →
7	Nothing found. Will continue search.	N N

Note: These visual signals have been accepted for international use and appear in Annex 12 to the Convention on International Civil Aviation.

FIG 6-2-3
Urgent Medical Assistance

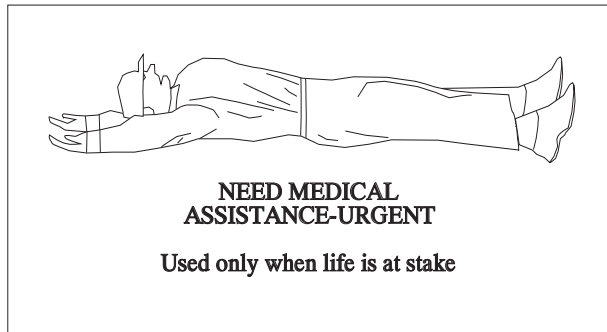

FIG 6-2-5
Short Delay

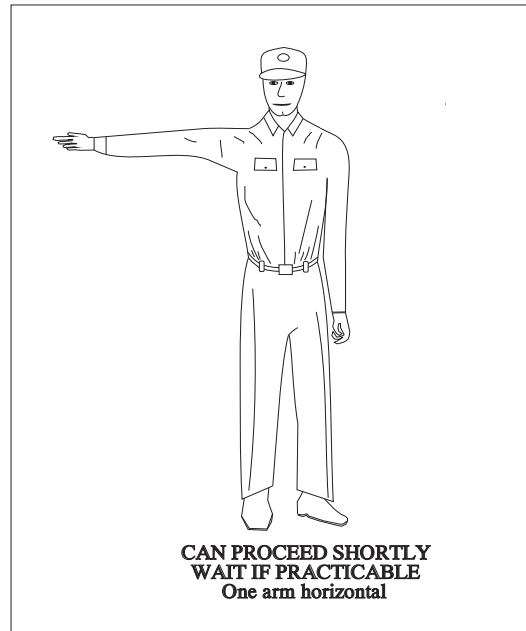

FIG 6-2-4
All OK

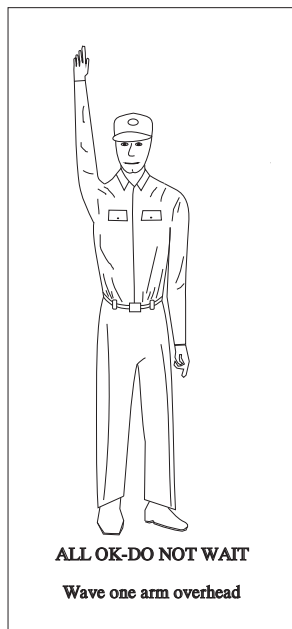

FIG 6-2-6
Long Delay

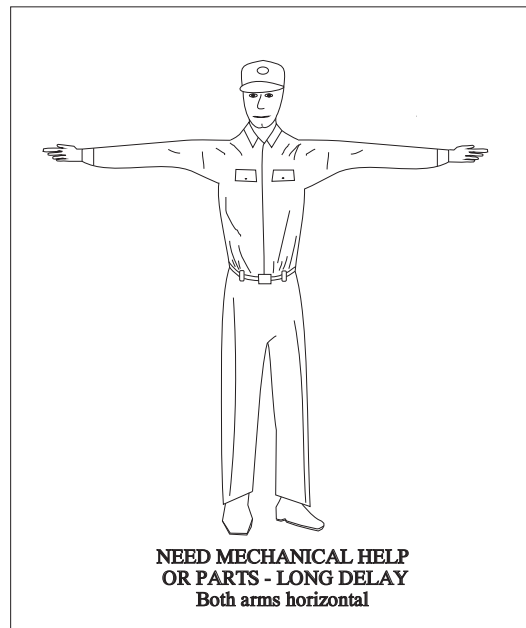

FIG 6-2-7
Drop Message

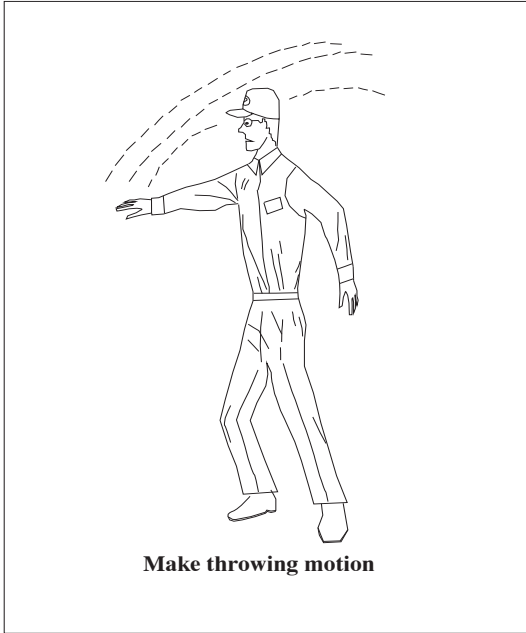

FIG 6-2-9
Do Not Land Here

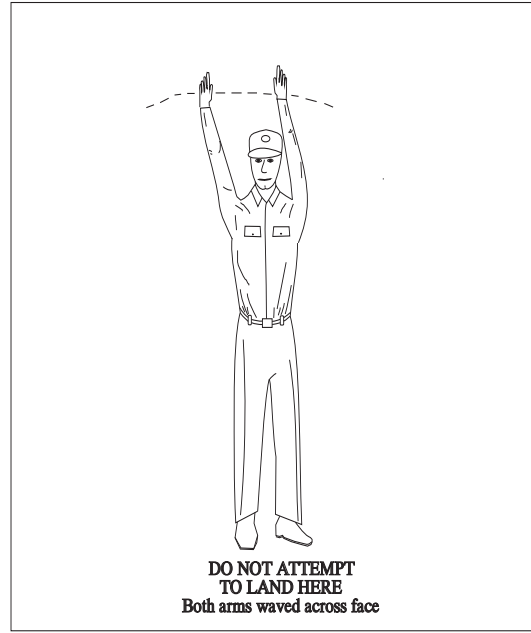

FIG 6-2-8
Receiver Operates

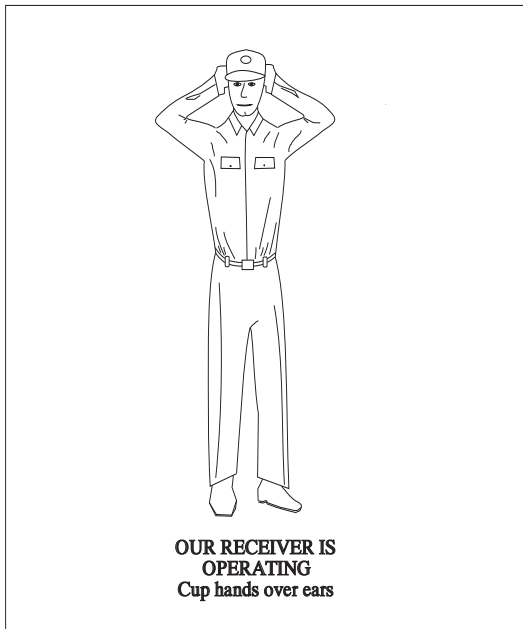

FIG 6-2-10
Land Here

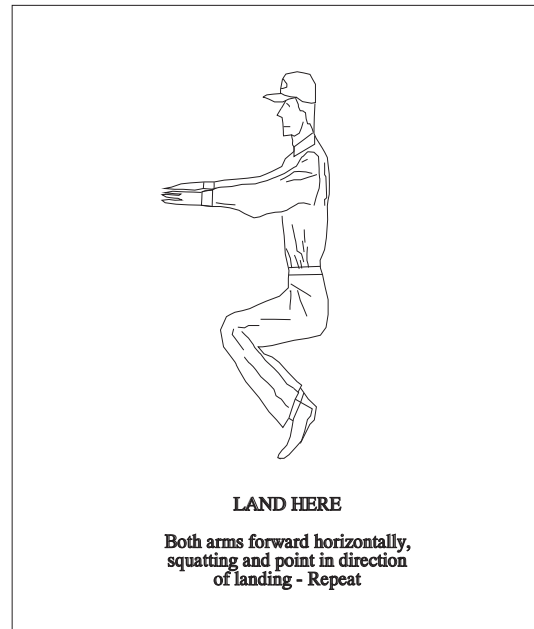

FIG 6-2-11
Negative (Ground)

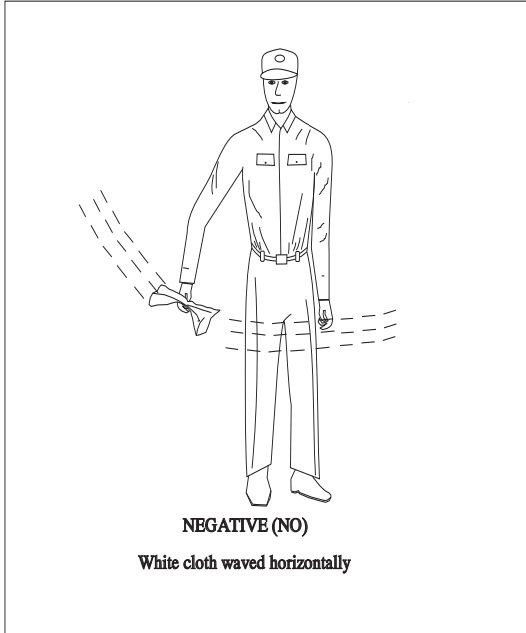

FIG 6-2-13
Pick Us Up

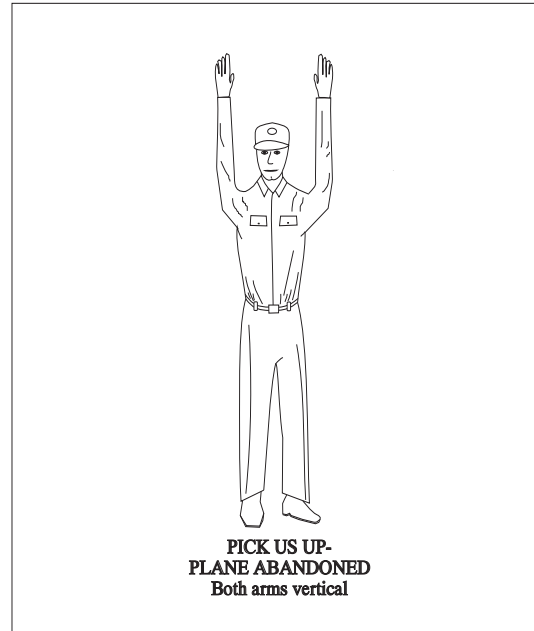

FIG 6-2-12
Affirmative (Ground)

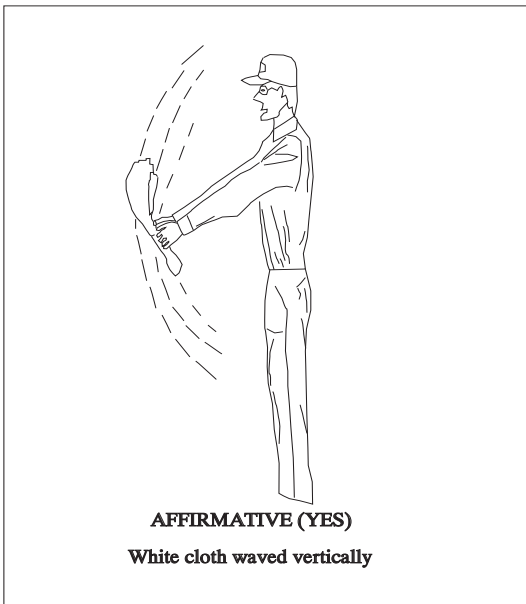

FIG 6-2-14
Affirmative (Aircraft)

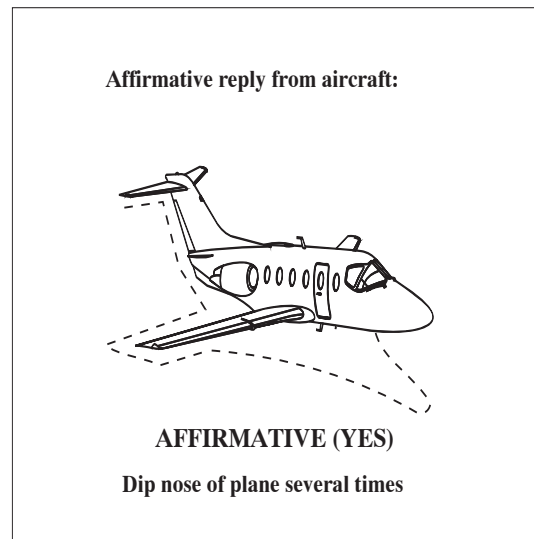

FIG 6-2-15
Negative (Aircraft)

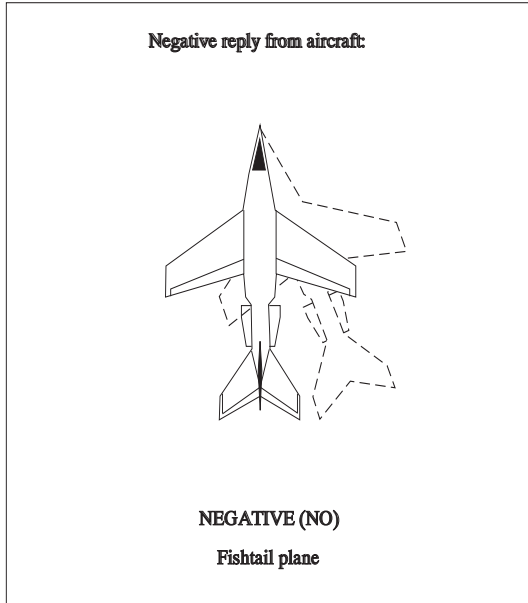

FIG 6-2-16
Message received and understood (Aircraft)

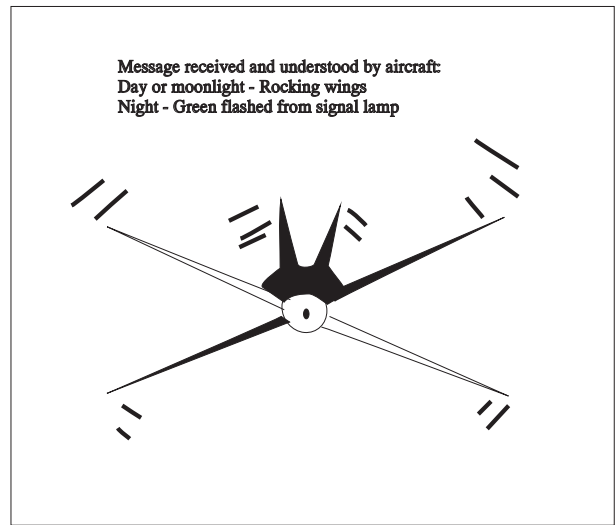
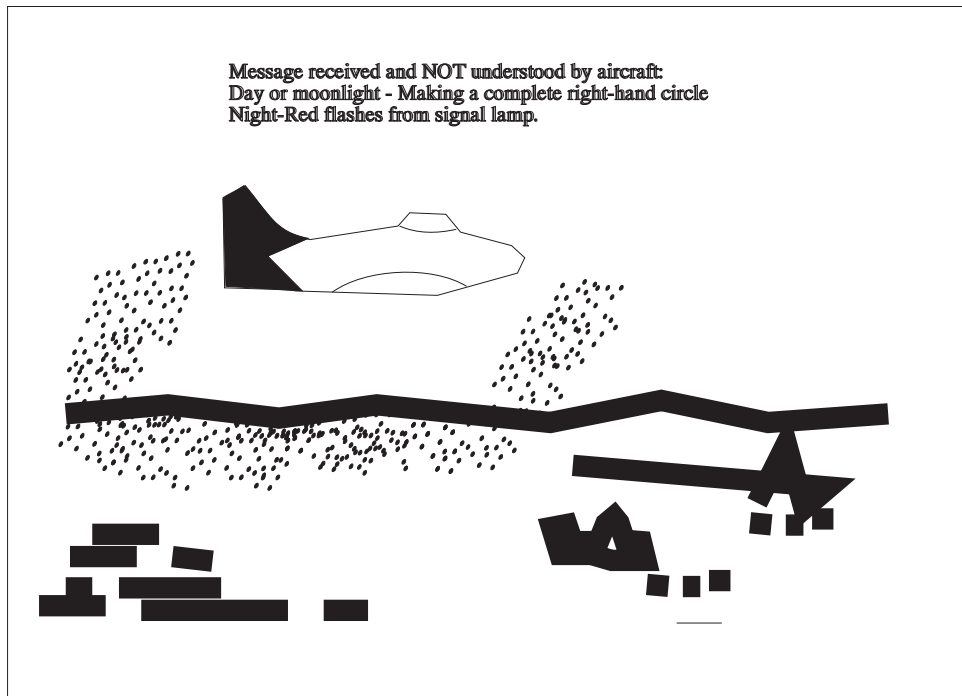

FIG 6-2-17
Message received and NOT understood (Aircraft)



Section 3. Distress and Urgency Procedures

6-3-1. Distress and Urgency Communications

a. A pilot who encounters a *distress* or *urgency* condition can obtain assistance simply by contacting the air traffic facility or other agency in whose area of responsibility the aircraft is operating, stating the nature of the difficulty, pilot's intentions and assistance desired. *Distress* and *urgency* communications procedures are prescribed by the International Civil Aviation Organization (ICAO), however, and have decided advantages over the informal procedure described above.

b. *Distress* and *urgency* communications procedures discussed in the following paragraphs relate to the use of air ground voice communications.

c. The initial communication, and if considered necessary, any subsequent transmissions by an aircraft in *distress* should begin with the signal MAYDAY, preferably repeated three times. The signal PAN-PAN should be used in the same manner for an *urgency* condition.

d. *Distress* communications have absolute priority over all other communications, and the word MAYDAY commands radio silence on the frequency in use. *Urgency* communications have priority over all other communications except *distress*, and the word PAN-PAN warns other stations not to interfere with *urgency* transmissions.

e. Normally, the station addressed will be the air traffic facility or other agency providing air traffic services, on the frequency in use at the time. If the pilot is not communicating and receiving services, the station to be called will normally be the air traffic facility or other agency in whose area of responsibility the aircraft is operating, on the appropriate assigned frequency. If the station addressed does not respond, or if time or the situation dictates, the *distress* or *urgency* message may be broadcast, or a collect call may be used, addressing "Any Station (Tower)(Radio)(Radar)."

f. The station addressed should immediately acknowledge a *distress* or *urgency* message, provide assistance, coordinate and direct the activities of assisting facilities, and alert the appropriate search

and rescue coordinator if warranted. Responsibility will be transferred to another station only if better handling will result.

g. All other stations, aircraft and ground, will continue to listen until it is evident that assistance is being provided. If any station becomes aware that the station being called either has not received a *distress* or *urgency* message, or cannot communicate with the aircraft in difficulty, it will attempt to contact the aircraft and provide assistance.

h. Although the frequency in use or other frequencies assigned by ATC are preferable, the following emergency frequencies can be used for distress or urgency communications, if necessary or desirable:

121.5 MHz and 243.0 MHz. Both have a range generally limited to line of sight. 121.5 MHz is guarded by direction finding stations and some military and civil aircraft. 243.0 MHz is guarded by military aircraft. Both 121.5 MHz and 243.0 MHz are guarded by military towers, most civil towers, and radar facilities. Normally ARTCC emergency frequency capability does not extend to radar coverage limits. If an ARTCC does not respond when called on 121.5 MHz or 243.0 MHz, call the nearest tower.

6-3-2. Obtaining Emergency Assistance

a. A pilot in any *distress* or *urgency* condition should *immediately* take the following action, not necessarily in the order listed, to obtain assistance:

1. Climb, if possible, for improved communications, and better radar and direction finding detection. However, it must be understood that unauthorized climb or descent under IFR conditions within controlled airspace is prohibited, except as permitted by 14 CFR Section 91.3(b).

2. If equipped with a radar beacon transponder (civil) or IFF/SIF (military):

(a) Continue squawking assigned Mode A/3 discrete code/VFR code and Mode C altitude encoding when in radio contact with an air traffic facility or other agency providing air traffic services, unless instructed to do otherwise.

(b) If unable to immediately establish communications with an air traffic facility/agency, squawk Mode A/3, Code 7700/Emergency and Mode C.

3. Transmit a *distress* or *urgency* message consisting of *as many* as necessary of the following elements, preferably in the order listed:

(a) If distress, MAYDAY, MAYDAY, MAYDAY; if *urgency*, PAN-PAN, PAN-PAN, PAN-PAN.

(b) Name of station addressed.

(c) Aircraft identification and type.

(d) Nature of *distress* or *urgency*.

(e) Weather.

(f) Pilots intentions and request.

(g) Present position, and heading; or if *lost*, last known position, time, and heading since that position.

(h) Altitude or flight level.

(i) Fuel remaining in minutes.

(j) Number of people on board.

(k) Any other useful information.

REFERENCE-

Pilot/Controller Glossary Term- Fuel Remaining.

b. After establishing radio contact, comply with advice and instructions received. Cooperate. Do not hesitate to ask questions or clarify instructions when you do not understand or if you cannot comply with clearance. Assist the ground station to control communications on the frequency in use. Silence interfering radio stations. Do not change frequency or change to another ground station unless absolutely

necessary. If you do, advise the ground station of the new frequency and station name prior to the change, transmitting in the blind if necessary. If two-way communications cannot be established on the new frequency, return immediately to the frequency or station where two-way communications last existed.

c. When in a distress condition with bailout, crash landing or ditching imminent, take the following additional actions to assist search and rescue units:

1. Time and circumstances permitting, transmit as many as necessary of the message elements in subparagraph a3 above, and any of the following that you think might be helpful:

(a) ELT status.

(b) Visible landmarks.

(c) Aircraft color.

(d) Number of persons on board.

(e) Emergency equipment on board.

2. Actuate your ELT if the installation permits.

3. For bailout, and for crash landing or ditching if risk of fire is not a consideration, set your radio for continuous transmission.

4. If it becomes necessary to ditch, make every effort to ditch near a surface vessel. If time permits, an FAA facility should be able to get the position of the nearest commercial or Coast Guard vessel from a Coast Guard Rescue Coordination Center.

5. After a crash landing, unless you have good reason to believe that you will not be located by search aircraft or ground teams, it is best to remain with your aircraft and prepare means for signaling search aircraft.

6-3-3. Ditching Procedures

FIG 6-3-1
Single Swell (15 knot wind)

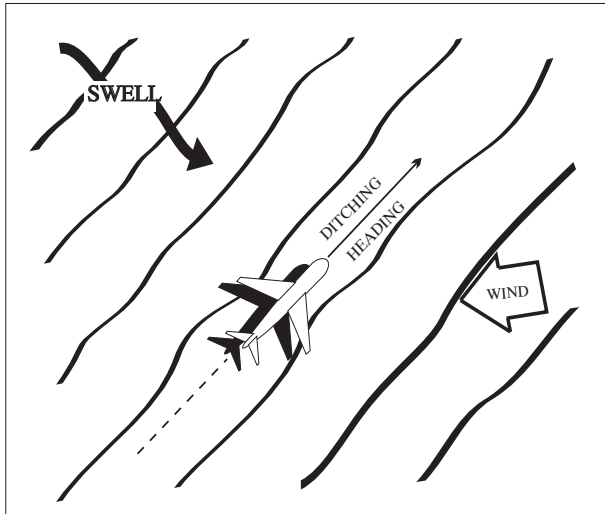

FIG 6-3-3
Double Swell (30 knot wind)

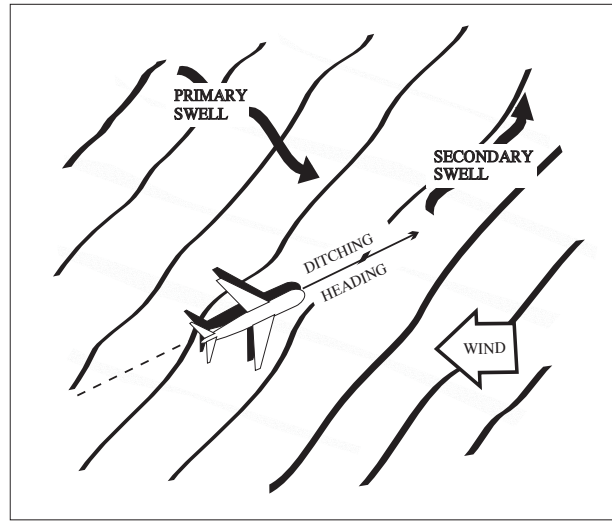

FIG 6-3-2
Double Swell (15 knot wind)

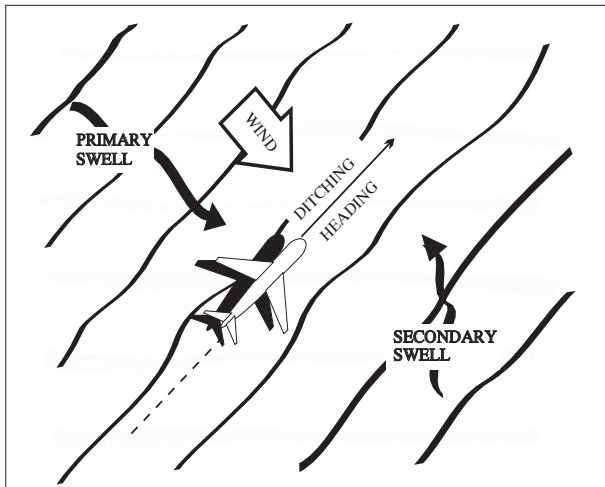

FIG 6-3-4
(50 knot wind)

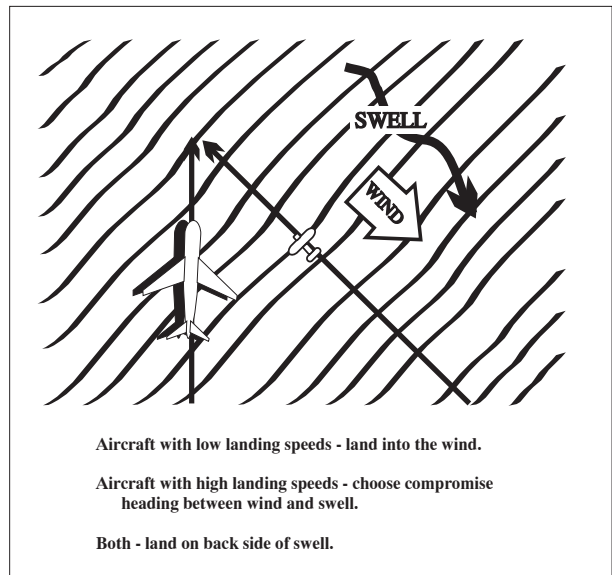
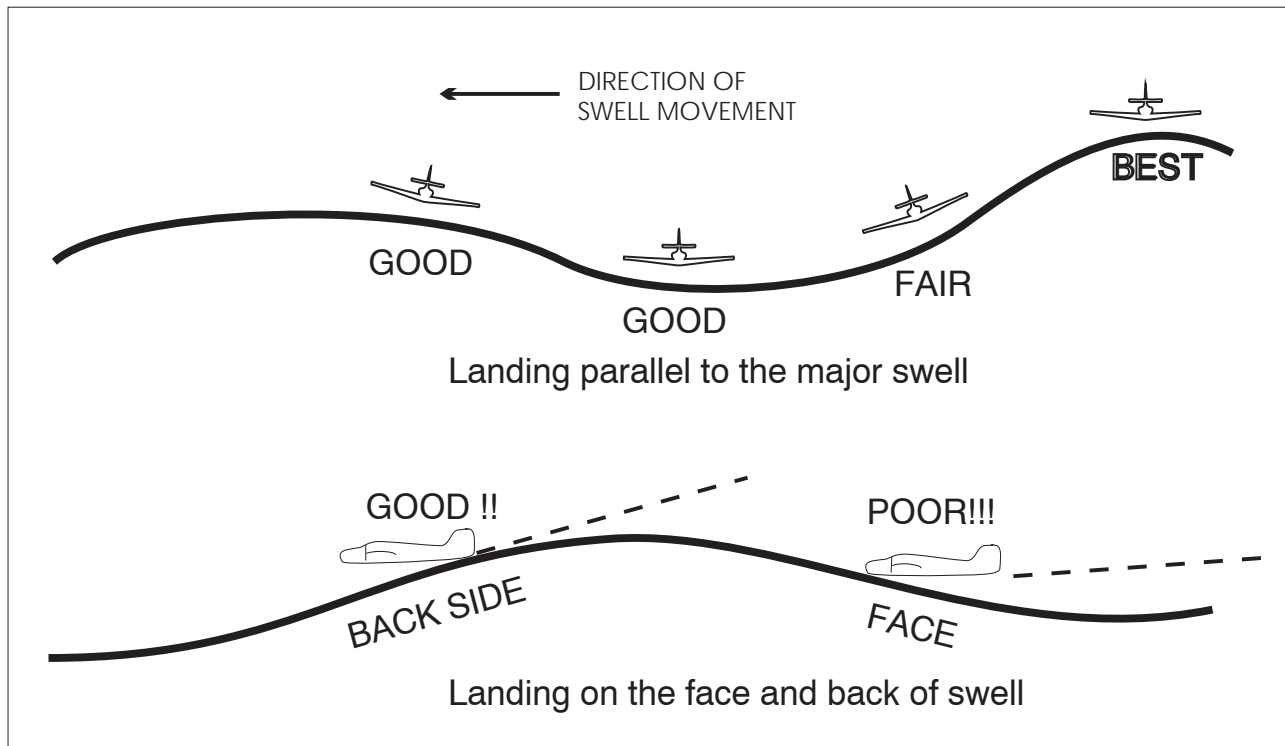

FIG 6-3-5
Wind-Swell-Ditch Heading



a. A successful aircraft ditching is dependent on three primary factors. In order of importance they are:

1. **Sea conditions and wind.**
2. **Type of aircraft.**
3. **Skill and technique of pilot.**

b. **Common oceanographic terminology.**

1. **Sea.** The condition of the surface that is the result of both waves and swells.

2. **Wave (or Chop).** The condition of the surface caused by the local winds.

3. **Swell.** The condition of the surface which has been caused by a distance disturbance.

4. **Swell Face.** The side of the swell toward the observer. The backside is the side away from the observer. These definitions apply regardless of the direction of swell movement.

5. **Primary Swell.** The swell system having the greatest height from trough to crest.

6. **Secondary Swells.** Those swell systems of less height than the primary swell.

7. **Fetch.** The distance the waves have been driven by a wind blowing in a constant direction, without obstruction.

8. **Swell Period.** The time interval between the passage of two successive crests at the same spot in the water, measured in seconds.

9. **Swell Velocity.** The speed and direction of the swell with relation to a fixed reference point, measured in knots. There is little movement of water in the horizontal direction. Swells move primarily in a vertical motion, similar to the motion observed when shaking out a carpet.

10. **Swell Direction.** The direction *from* which a swell is moving. This direction is not necessarily the result of the wind present at the scene. The swell may be moving into or across the local wind. Swells, once set in motion, tend to maintain their original direction for as long as they continue in deep water, regardless of changes in wind direction.

11. Swell Height. The height between crest and trough, measured in feet. The vast majority of ocean swells are lower than 12 to 15 feet, and swells over 25 feet are not common at any spot on the oceans. Successive swells may differ considerably in height.

c. In order to select a good heading when ditching an aircraft, a basic evaluation of the sea is required. Selection of a good ditching heading may well minimize damage and could save your life. It can be extremely dangerous to land into the wind without regard to sea conditions; the swell system, or systems, must be taken into consideration. Remember one axiom—***AVOID THE FACE OF A SWELL.***

1. In ditching parallel to the swell, it makes little difference whether touchdown is on the top of the crest or in the trough. It is preferable, however, to land on the top or back side of the swell, if possible. After determining which heading (and its reciprocal) will parallel the swell, select the heading with the most into the wind component.

2. If only one swell system exists, the problem is relatively simple—even with a high, fast system. Unfortunately, most cases involve two or more swell systems running in different directions. With more than one system present, the sea presents a confused appearance. One of the most difficult situations occurs when two swell systems are at right angles. For example, if one system is eight feet high, and the other three feet, plan to land parallel to the primary system, and on the down swell of the secondary system. If both systems are of equal height, a compromise may be advisable—select an intermediate heading at 45 degrees down swell to both systems. When landing down a secondary swell, attempt to touch down on the back side, not on the face of the swell.

3. If the swell system is formidable, it is considered advisable, in landplanes, to accept more crosswind in order to avoid landing directly into the swell.

4. The secondary swell system is often from the same direction as the wind. Here, the landing may be made parallel to the primary system, with the wind and secondary system at an angle. There is a choice to two directions paralleling the primary system. One direction is downwind and down the secondary swell, and the other is into the wind and into the secondary

swell, the choice will depend on the velocity of the wind versus the velocity and height of the secondary swell.

d. The simplest method of estimating the wind direction and velocity is to examine the windstreaks on the water. These appear as long streaks up and down wind. Some persons may have difficulty determining wind direction after seeing the streaks on the water. Whitecaps fall forward with the wind but are overrun by the waves thus producing the illusion that the foam is sliding backward. Knowing this, and by observing the direction of the streaks, the wind direction is easily determined. Wind velocity can be estimated by noting the appearance of the whitecaps, foam and wind streaks.

1. The behavior of the aircraft on making contact with the water will vary within wide limits according to the state of the sea. If landed parallel to a single swell system, the behavior of the aircraft may approximate that to be expected on a smooth sea. If landed into a heavy swell or into a confused sea, the deceleration forces may be extremely great—resulting in breaking up of the aircraft. Within certain limits, the pilot is able to minimize these forces by proper sea evaluation and selection of ditching heading.

2. When on final approach the pilot should look ahead and observe the surface of the sea. There may be shadows and whitecaps—signs of large seas. Shadows and whitecaps close together indicate short and rough seas. Touchdown in these areas is to be avoided. Select and touchdown in any area (only about 500 feet is needed) where the shadows and whitecaps are not so numerous.

3. Touchdown should be at the *lowest* speed and rate of descent which permit safe handling and optimum nose up attitude on impact. Once first impact has been made, there is often little the pilot can do to control a landplane.

e. Once preditching preparations are completed, the pilot should turn to the ditching heading and commence let-down. The aircraft should be flown low over the water, and slowed down until ten knots or so above stall. At this point, additional power should be used to overcome the increased drag caused by the nose up attitude. When a smooth stretch of water appears ahead, cut power, and touchdown at the best recommended speed as fully stalled as possible. By cutting power when approaching a relatively smooth area, the pilot will prevent overshooting and

will touchdown with less chance of planing off into a second uncontrolled landing. Most experienced seaplane pilots prefer to make contact with the water in a semi-stalled attitude, cutting power as the tail makes contact. This technique eliminates the chance of misjudging altitude with a resultant heavy drop in a fully stalled condition. Care must be taken not to drop the aircraft from too high altitude or to balloon due to excessive speed. The altitude above water depends on the aircraft. Over glassy smooth water, or at night without sufficient light, it is very easy, for even the most experienced pilots to misjudge altitude by 50 feet or more. Under such conditions, carry enough power to maintain nine to twelve degrees nose up attitude, and 10 to 20 percent over stalling speed until contact is made with the water. The proper use of power on the approach is of great importance. If power is available on one side only, a little power should be used to flatten the approach; however, the engine should not be used to such an extent that the aircraft cannot be turned against the good engines right down to the stall with a margin of rudder movement available. When near the stall, sudden application of excessive unbalanced power may result in loss of directional control. If power is available on one side only, a slightly higher than normal glide approach speed should be used. This will ensure good control and some margin of speed after leveling off without excessive use of power. The use of power in ditching is so important that when it is certain that the coast cannot be reached, the pilot should, if possible, ditch before fuel is exhausted. The use of power in a night or instrument ditching is far more essential than under daylight contact conditions.

1. If no power is available, a greater than normal approach speed should be used down to the flare-out. This speed margin will allow the glide to be broken early and more gradually, thereby giving the pilot time and distance to feel for the surface – decreasing the possibility of stalling high or flying into the water. When landing parallel to a swell system, little difference is noted between landing on top of a crest or in the trough. If the wings of aircraft are trimmed to the surface of the sea rather than the horizon, there is little need to worry about a wing hitting a swell crest. The actual slope of a swell is very gradual. If forced to land into a swell, touchdown should be

made just after passage of the crest. If contact is made on the face of the swell, the aircraft may be swamped or thrown violently into the air, dropping heavily into the next swell. If control surfaces remain intact, the pilot should attempt to maintain the proper nose above the horizon attitude by rapid and positive use of the controls.

- f. **After Touchdown.** In most cases drift, caused by crosswind can be ignored; the forces acting on the aircraft after touchdown are of such magnitude that drift will be only a secondary consideration. If the aircraft is under good control, the “crab” may be kicked out with rudder just prior to touchdown. This is more important with high wing aircraft, for they are laterally unstable on the water in a crosswind and may roll to the side in ditching.

REFERENCE–

This information has been extracted from Appendix H of the “National Search and Rescue Manual.”

6–3–4. Special Emergency (Air Piracy)

- a. A special emergency is a condition of air piracy, or other hostile act by a person(s) aboard an aircraft, which threatens the safety of the aircraft or its passengers.

- b. The pilot of an aircraft reporting a special emergency condition should:

1. If circumstances permit, apply *distress* or *urgency* radio-telephony procedures. Include the details of the special emergency.

REFERENCE–

AIM, Paragraph 6–3–1, Distress and Urgency Communications

2. If circumstances do not permit the use of prescribed *distress* or *urgency* procedures, transmit:

- (a) On the air/ground frequency in use at the time.

- (b) As many as possible of the following elements spoken distinctly and in the following order:

- (1) Name of the station addressed (time and circumstances permitting).

- (2) The identification of the aircraft and present position.

- (3) The nature of the special emergency condition and pilot intentions (circumstances permitting).

(4) If unable to provide this information, use code words and/or transponder as follows:

Spoken Words TRANSPONDER SEVEN FIVE ZERO ZERO
Meaning I am being hijacked/forced to a new destination
Transponder Setting Mode 3/A, Code 7500

NOTE-

Code 7500 will never be assigned by ATC without prior notification from the pilot that the aircraft is being subjected to unlawful interference. The pilot should refuse the assignment of Code 7500 in any other situation and inform the controller accordingly. Code 7500 will trigger the special emergency indicator in all radar ATC facilities.

c. Air traffic controllers will acknowledge and confirm receipt of transponder Code 7500 by asking the pilot to verify it. If the aircraft is not being subjected to unlawful interference, the pilot should respond to the query by broadcasting in the clear that the aircraft is not being subjected to unlawful interference. Upon receipt of this information, the controller will request the pilot to verify the code selection depicted in the code selector windows in the transponder control panel and change the code to the appropriate setting. If the pilot replies in the affirmative or does not reply, the controller will not ask further questions but will flight follow, respond to pilot requests and notify appropriate authorities.

d. If it is possible to do so without jeopardizing the safety of the flight, the pilot of a hijacked passenger aircraft, after departing from the cleared routing over which the aircraft was operating, will attempt to do one or more of the following things, insofar as circumstances may permit:

1. Maintain a true airspeed of no more than 400 knots, and preferably an altitude of between 10,000 and 25,000 feet.

2. Fly a course toward the destination which the hijacker has announced.

e. If these procedures result in either radio contact or air intercept, the pilot will attempt to comply with any instructions received which may direct the aircraft to an appropriate landing field or alter the aircraft's flight path off its current course, away from protected airspace.

6-3-5. Fuel Dumping

a. Should it become necessary to dump fuel, the pilot should immediately advise ATC. Upon receipt of information that an aircraft will dump fuel, ATC will broadcast or cause to be broadcast immediately and every 3 minutes thereafter the following on appropriate ATC and FSS radio frequencies:

EXAMPLE-

Attention all aircraft – fuel dumping in progress over – (location) at (altitude) by (type aircraft) (flight direction).

b. Upon receipt of such a broadcast, pilots of aircraft affected, which are not on IFR flight plans or special VFR clearances, should clear the area specified in the advisory. Aircraft on IFR flight plans or special VFR clearances will be provided specific separation by ATC. At the termination of the fuel dumping operation, pilots should advise ATC. Upon receipt of such information, ATC will issue, on the appropriate frequencies, the following:

EXAMPLE-

ATTENTION ALL AIRCRAFT – FUEL DUMPING BY – (type aircraft) – TERMINATED.

Section 4. Two-way Radio Communications Failure

6-4-1. Two-way Radio Communications Failure

a. It is virtually impossible to provide regulations and procedures applicable to all possible situations associated with two-way radio communications failure. During two-way radio communications failure, when confronted by a situation not covered in the regulation, pilots are expected to exercise good judgment in whatever action they elect to take. Should the situation so dictate they should not be reluctant to use the emergency action contained in 14 CFR Section 91.3(b).

b. Whether two-way communications failure constitutes an emergency depends on the circumstances, and in any event, it is a determination made by the pilot. 14 CFR Section 91.3(b) authorizes a pilot to deviate from any rule in Subparts A and B to the extent required to meet an emergency.

c. In the event of two-way radio communications failure, ATC service will be provided on the basis that the pilot is operating in accordance with 14 CFR Section 91.185. A pilot experiencing two-way communications failure should (unless emergency authority is exercised) comply with 14 CFR Section 91.185 quoted below:

1. General. Unless otherwise authorized by ATC, each pilot who has two-way radio communications failure when operating under IFR must comply with the rules of this section.

2. VFR conditions. If the failure occurs in VFR conditions, or if VFR conditions are encountered after the failure, each pilot must continue the flight under VFR and land as soon as practicable.

NOTE-

This procedure also applies when two-way radio failure occurs while operating in Class A airspace. The primary objective of this provision in 14 CFR Section 91.185 is to preclude extended IFR operation by these aircraft within the ATC system. Pilots should recognize that operation under these conditions may unnecessarily as well as adversely affect other users of the airspace, since ATC may be required to reroute or delay other users in order to protect the failure aircraft. However, it is not intended that the requirement to “land as soon as practicable” be construed to mean “as soon as possible.” Pilots retain the prerogative of exercising their best judgment and are not

required to land at an unauthorized airport, at an airport unsuitable for the type of aircraft flown, or to land only minutes short of their intended destination.

3. IFR conditions. If the failure occurs in IFR conditions, or if subparagraph 2 above cannot be complied with, each pilot must continue the flight according to the following:

(a) Route.

(1) By the route assigned in the last ATC clearance received;

(2) If being radar vectored, by the direct route from the point of radio failure to the fix, route, or airway specified in the vector clearance;

(3) In the absence of an assigned route, by the route that ATC has advised may be expected in a further clearance; or

(4) In the absence of an assigned route or a route that ATC has advised may be expected in a further clearance by the route filed in the flight plan.

(b) Altitude. At the HIGHEST of the following altitudes or flight levels FOR THE ROUTE SEGMENT BEING FLOWN:

(1) The altitude or flight level assigned in the last ATC clearance received;

(2) The minimum altitude (converted, if appropriate, to minimum flight level as prescribed in 14 CFR Section 91.121(c)) for IFR operations; or

(3) The altitude or flight level ATC has advised may be expected in a further clearance.

NOTE-

The intent of the rule is that a pilot who has experienced two-way radio failure should select the appropriate altitude for the particular route segment being flown and make the necessary altitude adjustments for subsequent route segments. If the pilot received an “expect further clearance” containing a higher altitude to expect at a specified time or fix, maintain the highest of the following altitudes until that time/fix:

(1) the last assigned altitude; or

(2) the minimum altitude/flight level for IFR operations.

Upon reaching the time/fix specified, the pilot should commence climbing to the altitude advised to expect. If the

radio failure occurs after the time/fix specified, the altitude to be expected is not applicable and the pilot should maintain an altitude consistent with 1 or 2 above. If the pilot receives an “expect further clearance” containing a lower altitude, the pilot should maintain the highest of 1 or 2 above until that time/fix specified in subparagraph (c) Leave clearance limit, below.

EXAMPLE–

1. *A pilot experiencing two-way radio failure at an assigned altitude of 7,000 feet is cleared along a direct route which will require a climb to a minimum IFR altitude of 9,000 feet, should climb to reach 9,000 feet at the time or place where it becomes necessary (see 14 CFR Section 91.177(b)). Later while proceeding along an airway with an MEA of 5,000 feet, the pilot would descend to 7,000 feet (the last assigned altitude), because that altitude is higher than the MEA.*

2. *A pilot experiencing two-way radio failure while being progressively descended to lower altitudes to begin an approach is assigned 2,700 feet until crossing the VOR and then cleared for the approach. The MOCA along the airway is 2,700 feet and MEA is 4,000 feet. The aircraft is within 22 NM of the VOR. The pilot should remain at 2,700 feet until crossing the VOR because that altitude is the minimum IFR altitude for the route segment being flown.*

3. *The MEA between a and b: 5,000 feet. The MEA between b and c: 5,000 feet. The MEA between c and d: 11,000 feet. The MEA between d and e: 7,000 feet. A pilot had been cleared via a, b, c, d, to e. While flying between a and b the assigned altitude was 6,000 feet and the pilot was told to expect a clearance to 8,000 feet at b. Prior to receiving the higher altitude assignment, the pilot experienced two-way failure. The pilot would maintain 6,000 to b, then climb to 8,000 feet (the altitude advised to expect). The pilot would maintain 8,000 feet, then climb to 11,000 at c, or prior to c if necessary to comply with an MCA at c. (14 CFR Section 91.177(b).) Upon reaching d, the pilot would descend to 8,000 feet (even though the MEA was 7,000 feet), as 8,000 was the highest of the altitude situations stated in the rule (14 CFR Section 91.185).*

(c) Leave clearance limit.

(1) When the clearance limit is a fix from which an approach begins, commence descent or descent and approach as close as possible to the expect further clearance time if one has been received, or if one has not been received, as close as possible to the Estimated Time of Arrival (ETA) as

calculated from the filed or amended (with ATC) Estimated Time En Route (ETE).

(2) If the clearance limit is not a fix from which an approach begins, leave the clearance limit at the expect further clearance time if one has been received, or if none has been received, upon arrival over the clearance limit, and proceed to a fix from which an approach begins and commence descent or descent and approach as close as possible to the estimated time of arrival as calculated from the filed or amended (with ATC) estimated time en route.

6–4–2. Transponder Operation During Two-way Communications Failure

a. If an aircraft with a coded radar beacon transponder experiences a loss of two-way radio capability, the pilot should adjust the transponder to reply on Mode A/3, Code 7600.

b. The pilot should understand that the aircraft may not be in an area of radar coverage.

6–4–3. Reestablishing Radio Contact

a. In addition to monitoring the NAVAID voice feature, the pilot should attempt to reestablish communications by attempting contact:

- 1.** On the previously assigned frequency; or
- 2.** With an FSS or *ARINC.

b. If communications are established with an FSS or ARINC, the pilot should advise that radio communications on the previously assigned frequency has been lost giving the aircraft’s position, altitude, last assigned frequency and then request further clearance from the controlling facility. The preceding does not preclude the use of 121.5 MHz. There is no priority on which action should be attempted first. If the capability exists, do all at the same time.

NOTE–

**Aeronautical Radio/Incorporated (ARINC) is a commercial communications corporation which designs, constructs, operates, leases or otherwise engages in radio activities serving the aviation community. ARINC has the capability of relaying information to/from ATC facilities throughout the country.*

Section 5. Aircraft Rescue and Fire Fighting Communications

6-5-1. Discrete Emergency Frequency

a. Direct contact between an emergency aircraft flight crew, Aircraft Rescue and Fire Fighting Incident Commander (ARFF IC), and the Airport Traffic Control Tower (ATCT), is possible on an aeronautical radio frequency (Discrete Emergency Frequency [DEF]), designated by Air Traffic Control (ATC) from the operational frequencies assigned to that facility.

b. Emergency aircraft at airports without an ATCT, (or when the ATCT is closed), may contact the ARFF IC (if ARFF service is provided), on the Common Traffic Advisory Frequency (CTAF) published for the airport or the civil emergency frequency **121.5 MHz**.

6-5-2. Radio Call Signs

Preferred radio call sign for the ARFF IC is “(location/facility) **Command**” when communicating with the flight crew and the FAA ATCT.

EXAMPLE-

LAX Command.

Washington Command.

6-5-3. ARFF Emergency Hand Signals

In the event that electronic communications cannot be maintained between the ARFF IC and the flight crew, standard emergency hand signals as depicted in FIG 6-5-1 through FIG 6-5-3 should be used. These hand signals should be known and understood by all cockpit and cabin aircrew, and all ARFF firefighters.

FIG 6-5-1

Recommend Evacuation

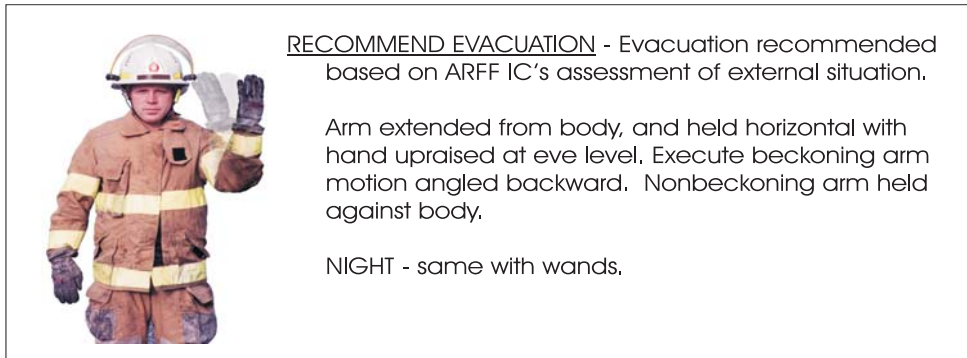

FIG 6-5-2

Recommend Stop

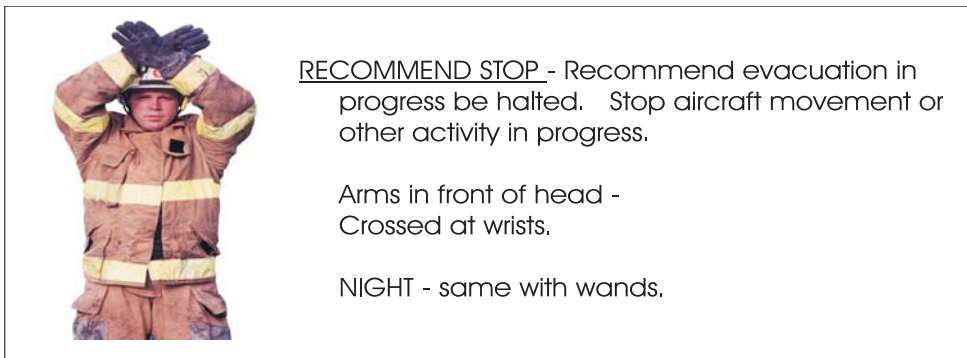

FIG 6-5-3

Emergency Contained

EMERGENCY CONTAINED - No outside evidence of dangerous condition or "all-clear."

Arms extended outward and down at a 45 degree angle. Arms moved inward below waistline simultaneously until wrists crossed, then extended outward to starting position (umpire's "safe" signal).

NIGHT - same with wands.

Chapter 7. Safety of Flight

Section 1. Meteorology

7-1-1. National Weather Service Aviation Weather Service Program

a. Weather service to aviation is a joint effort of the National Oceanic and Atmospheric Administration (NOAA), the National Weather Service (NWS), the Federal Aviation Administration (FAA), Department of Defense, and various private sector aviation weather service providers. Requirements for all aviation weather products originate from the FAA, which is the Meteorological Authority for the U.S.

b. NWS meteorologists are assigned to all air route traffic control centers (ARTCC) as part of the Center Weather Service Units (CWSU) as well as the Air Traffic Control System Command Center (ATCSCC). These meteorologists provide specialized briefings as well as tailored forecasts to support the needs of the FAA and other users of the NAS.

c. Aviation Products

1. The NWS maintains an extensive surface, upper air, and radar weather observing program; and a nationwide aviation weather forecasting service.

2. Airport observations (METAR and SPECI) supported by the NWS are provided by automated observing systems.

3. Terminal Aerodrome Forecasts (TAF) are prepared by 123 NWS Weather Forecast Offices (WFOs) for over 700 airports. These forecasts are valid for 24 or 30 hours and amended as required.

4. Inflight aviation advisories (for example, Significant Meteorological Information (SIGMETs) and Airmen's Meteorological Information (AIRMETs)) are issued by three NWS Meteorological Watch Offices; the Aviation Weather Center (AWC) in Kansas City, MO, the Alaska Aviation Weather Unit (AAWU) in Anchorage, AK, and the WFO in Honolulu, HI. Both the AWC and the AAWU issue area forecasts (FA) for selected areas. In addition, NWS meteorologists assigned to most ARTCCs as part of the Center Weather Service Unit (CWSU) provide Center Weather Advisories (CWAs) and

gather weather information to support the needs of the FAA and other users of the system.

5. Several NWS National Centers for Environmental Prediction (NCEP) provide aviation specific weather forecasts, or select public forecasts which are of interest to pilots and operators.

(a) The Aviation Weather Center (AWC) displays a variety of domestic and international aviation forecast products over the Internet at aviationweather.gov.

(b) The NCEP Central Operations (NCO) is responsible for the operation of many numerical weather prediction models, including those which produce the many wind and temperature aloft forecasts.

(c) The Storm Prediction Center (SPC) issues tornado and severe weather watches along with other guidance forecasts.

(d) The National Hurricane Center (NHC) issues forecasts on tropical weather systems (for example, hurricanes).

(e) The Space Weather Prediction Center (SWPC) provides alerts, watches, warnings and forecasts for space weather events (for example, solar storms) affecting or expected to affect Earth's environment.

(f) The Weather Prediction Center (WPC) provides analysis and forecast products on a national scale including surface pressure and frontal analyses.

6. NOAA operates two Volcanic Ash Advisory Centers (VAAC) which issue forecasts of ash clouds following a volcanic eruption in their area of responsibility.

7. Details on the products provided by the above listed offices and centers is available in FAA Advisory Circular 00-45, Aviation Weather Services.

d. Weather element values may be expressed by using different measurement systems depending on several factors, such as whether the weather products will be used by the general public, aviation interests, international services, or a combination of these

users. FIG 7-1-1 provides conversion tables for the most used weather elements that will be encountered by pilots.

7-1-2. FAA Weather Services

a. The FAA provides the Flight Service program, which serves the weather needs of pilots through its flight service stations (FSS) (both government and contract via 1-800-WX-BRIEF) and via the Internet, through Leidos Flight Service.

b. The FAA maintains an extensive surface weather observing program. Airport observations (METAR and SPECI) in the U.S. are provided by automated observing systems. Various levels of human oversight of the METAR and SPECI reports and augmentation may be provided at select larger airports by either government or contract personnel qualified to report specified weather elements that cannot be detected by the automated observing system.

c. Other Sources of Weather Information

1. In Alaska, Telephone Information Briefing Service (TIBS) (FSS); Transcribed Weather Broadcast (TWEB) locations, and telephone access to the TWEB (TEL-TWEB) provide continuously updated recorded weather information for short or local flights. Separate paragraphs in this section give additional information regarding these services.

REFERENCE-

AIM, Paragraph 7-1-8, Telephone Information Briefing Service (TIBS) (Alaska only)

AIM, Paragraph 7-1-9, Transcribed Weather Broadcast (TWEB) (Alaska Only)

2. Weather and aeronautical information are also available from numerous private industry sources on an individual or contract pay basis. Information on how to obtain this service should be available from local pilot organizations.

3. Pilots can access Leidos Flight Services via the Internet. Pilots can receive preflight weather data and file domestic VFR and IFR flight plans. The following is the FAA contract vendor:

Leidos Flight Service

Internet Access: <http://www.1800wxbrief.com>

For customer service: 1-800-WXBRIEF

7-1-3. Use of Aviation Weather Products

a. Air carriers and operators certificated under the provisions of 14 CFR Part 119 are required to use the aeronautical weather information systems defined in the Operations Specifications issued to that certificate holder by the FAA. These systems may utilize basic FAA/National Weather Service (NWS) weather services, contractor- or operator-proprietary weather services and/or Enhanced Weather Information System (EWINS) when approved in the Operations Specifications. As an integral part of this system approval, the procedures for collecting, producing and disseminating aeronautical weather information, as well as the crew member and dispatcher training to support the use of system weather products, must be accepted or approved.

b. Operators not certificated under the provisions of 14 CFR Part 119 are encouraged to use FAA/NWS products through Flight Service Stations, Leidos Flight Service, and/or Flight Information Services-Broadcast (FIS-B).

c. The suite of available aviation weather product types is expanding, with the development of new sensor systems, algorithms and forecast models. The FAA and NWS, supported by various weather research laboratories and corporations under contract to the Government, develop and implement new aviation weather product types. The FAA's NextGen Aviation Weather Research Program (AWRP) facilitates collaboration between the NWS, the FAA, and various industry and research representatives. This collaboration ensures that user needs and technical readiness requirements are met before experimental products mature to operational application.

d. The AWRP manages the transfer of aviation weather R&D to operational use through technical review panels and conducting safety assessments to ensure that newly developed aviation weather products meet regulatory requirements and enhance safety.

FIG 7-1-1
Weather Elements Conversion Tables

TIME

STANDARD TO UTC

Eastern + 5 hr = UTC
 Central + 6 hr = UTC
 Mountain + 7 hr = UTC
 Pacific + 8 hr = UTC
 Alaskan + 9 hr = UTC
 Hawaii & Aleutian Islands + 10 hr = UTC

Subtract one hour for Daylight Time

WINDSPEED

MPH	KNOTS
1-2	1-2
3-8	3-7
9-14	8-12
15-20	13-17
21-26	18-22
26-31	23-27
32-37	28-32
38-43	33-37
44-49	38-42
50-54	43-47
55-60	48-52
61-66	53-57
67-71	58-62
72-77	63-67
78-83	68-72
84-89	73-77
119-123	103-107

Knots x 1.15 = Miles Per Hour
 Miles Per Hour x 0.869 = Knots

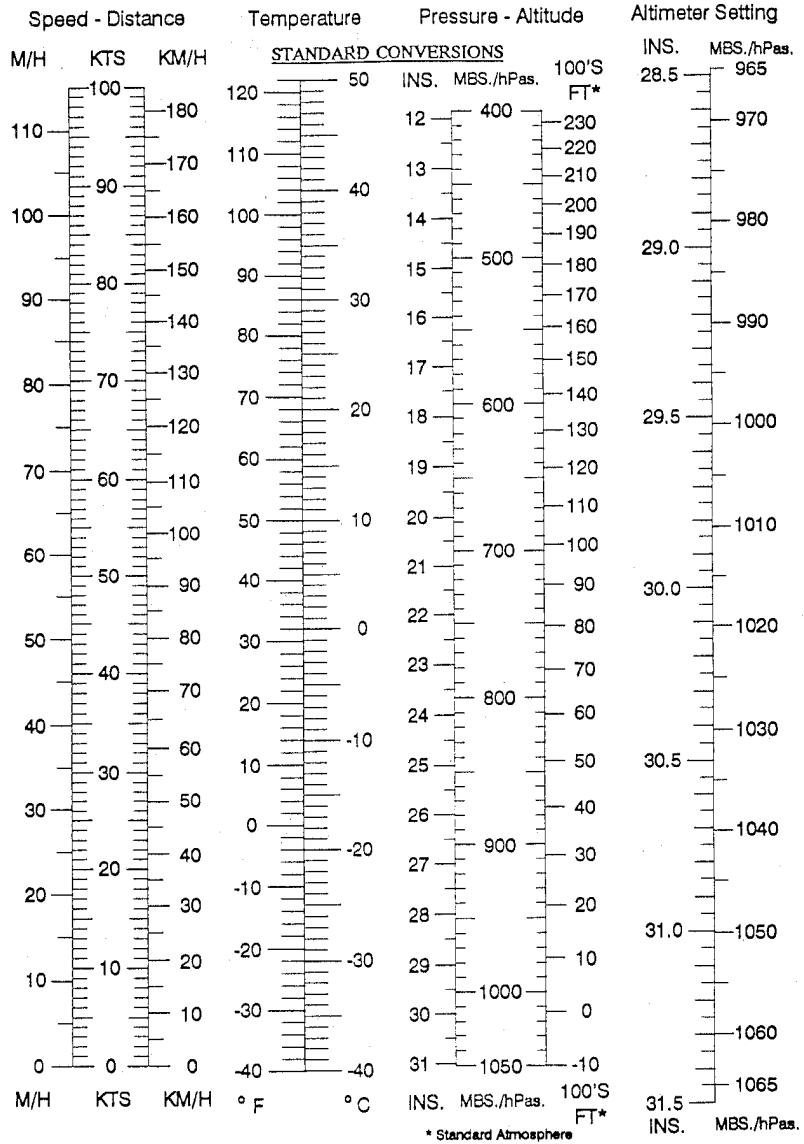

e. The AWRP review and decision-making process applies criteria to weather products at various stages. The stages are composed of the following:

1. Sponsorship of user needs.
2. R & D and controlled testing.
3. Experimental application.
4. Operational application.

f. Pilots and operators should be aware that weather services provided by entities other than FAA, NWS, or their contractors may not meet FAA/NWS quality control standards. Hence, operators and pilots contemplating using such services should request and/or review an appropriate description of services and provider disclosure. This should include, but is not limited to, the type of weather product (for example, current weather or forecast weather), the currency of the product (that is, product issue and valid times), and the relevance of the product. Pilots and operators should be cautious when using unfamiliar products, or products not supported by FAA/NWS technical specifications.

NOTE-

When in doubt, consult with a FAA Flight Service Station Specialist.

g. In addition, pilots and operators should be aware there are weather services and products available from government organizations beyond the scope of the AWRP process mentioned earlier in this section. For example, governmental agencies such as the NWS and the Aviation Weather Center (AWC), or research organizations such as the National Center for Atmospheric Research (NCAR) display weather “model data” and “experimental” products which require training and/or expertise to properly interpret and use. These products are developmental prototypes that are subject to ongoing research and can change without notice. Therefore, some data on display by government organizations, or government data on display by independent organizations may be unsuitable for flight planning purposes. Operators and pilots contemplating using such services should request and/or review an appropriate description of services and provider disclosure. This should include, but is not limited to, the type of weather product (for example, current weather or forecast weather), the currency of the product (i.e., product issue and valid times), and the relevance of the product. Pilots and

operators should be cautious when using unfamiliar weather products.

NOTE-

When in doubt, consult with a FAA Flight Service Station Specialist.

h. With increased access to weather products via the public Internet, the aviation community has access to an overwhelming amount of weather information and data that support self-briefing. FAA AC 00-45 (current edition) describes the weather products distributed by the NWS. Pilots and operators using the public Internet to access weather from a third party vendor should request and/or review an appropriate description of services and provider disclosure. This should include, but is not limited to, the type of weather product (for example, current weather or forecast weather), the currency of the product (i.e., product issue and valid times), and the relevance of the product. Pilots and operators should be cautious when using unfamiliar weather products and when in doubt, consult with a Flight Service Specialist.

i. The development of new weather products, coupled with the termination of some legacy textual and graphical products may create confusion between regulatory requirements and the new products. All flight-related, aviation weather decisions must be based on all available pertinent weather products. As every flight is unique and the weather conditions for that flight vary hour by hour, day to day, multiple weather products may be necessary to meet aviation weather regulatory requirements. Many new weather products now have a Precautionary Use Statement that details the proper use or application of the specific product.

j. The FAA has identified three distinct types of weather information available to pilots and operators.

1. Observations. Raw weather data collected by some type of sensor suite including surface and airborne observations, radar, lightning, satellite imagery, and profilers.

2. Analysis. Enhanced depiction and/or interpretation of observed weather data.

3. Forecasts. Predictions of the development and/or movement of weather phenomena based on meteorological observations and various mathematical models.

k. Not all sources of aviation weather information are able to provide all three types of weather

information. The FAA has determined that operators and pilots may utilize the following approved sources of aviation weather information:

1. Federal Government. The FAA and NWS collect raw weather data, analyze the observations, and produce forecasts. The FAA and NWS disseminate meteorological observations, analyses, and forecasts through a variety of systems. In addition, the Federal Government is the only approval authority for sources of weather observations; for example, contract towers and airport operators may be approved by the Federal Government to provide weather observations.

2. Enhanced Weather Information System (EWINS). An EWINS is an FAA authorized, proprietary system for tracking, evaluating, reporting, and forecasting the presence or lack of adverse weather phenomena. The FAA authorizes a certificate holder to use an EWINS to produce flight movement forecasts, adverse weather phenomena forecasts, and other meteorological advisories. For more detailed information regarding EWINS, see the Aviation Weather Services Advisory Circular 00-45 and the Flight Standards Information Management System 8900.1.

3. Commercial Weather Information Providers. In general, commercial providers produce proprietary weather products based on NWS/FAA products with formatting and layout modifications but no material changes to the weather information itself. This is also referred to as “repackaging.” In addition, commercial providers may produce analyses, forecasts, and other proprietary weather products that substantially alter the information contained in government-produced products. However, those proprietary weather products that substantially alter government-produced weather products or information, may only be approved for use by 14 CFR Part 121 and Part 135 certificate holders if the commercial provider is EWINS qualified.

NOTE—

Commercial weather information providers contracted by FAA to provide weather observations, analyses, and forecasts (e.g., contract towers) are included in the Federal Government category of approved sources by virtue of maintaining required technical and quality assurance standards under Federal Government oversight.

7-1-4. Graphical Forecasts for Aviation (GFA)

a. The GFA website is intended to provide the necessary aviation weather information to give users a complete picture of the weather that may affect flight in the continental United States (CONUS). The website includes observational data, forecasts, and warnings that can be viewed from 14 hours in the past to 15 hours in the future, including thunderstorms, clouds, flight category, precipitation, icing, turbulence, and wind. Hourly model data and forecasts, including information on clouds, flight category, precipitation, icing, turbulence, wind, and graphical output from the National Weather Service’s (NWS) National Digital Forecast Data (NDFD) are available. Wind, icing, and turbulence forecasts are available in 3,000 ft increments from the surface up to 30,000 ft MSL, and in 6,000 ft increments from 30,000 ft MSL to 48,000 ft MSL. Turbulence forecasts are also broken into low (below 18,000 ft MSL) and high (at or above 18,000 ft MSL) graphics. A maximum icing graphic and maximum wind velocity graphic (regardless of altitude) are also available. Built with modern geospatial information tools, users can pan and zoom to focus on areas of greatest interest. Target users are commercial and general aviation pilots, operators, briefers, and dispatchers.

b. Weather Products.

1. The Aviation Forecasts include gridded displays of various weather parameters as well as NWS textual weather observations, forecasts, and warnings. Icing, turbulence, and wind gridded products are three-dimensional. Other gridded products are two-dimensional and may represent a “composite” of a three-dimensional weather phenomenon or a surface weather variable, such as horizontal visibility. The following are examples of aviation forecasts depicted on the GFA:

- (a)** Terminal Aerodrome Forecast (TAF)
- (b)** Ceiling & Visibility (CIG/VIS)
- (c)** Clouds
- (d)** Precipitation / Weather (PCPN/WX)
- (e)** Thunderstorm (TS)
- (f)** Winds
- (g)** Turbulence
- (h)** Ice

2. Observations & Warnings (Obs/Warn).

The Obs/Warn option provides an option to display weather data for the current time and the previous 14 hours (rounded to the nearest hour). Users may advance through time using the arrow buttons or by clicking on the desired hour. Provided below are the Obs/Warn product tabs available on the GFA website:

- (a) METAR
- (b) Precipitation/Weather (PCPN/WX)
- (c) Ceiling & Visibility (CIG/VIS)
- (d) Pilot Reports (PIREP)
- (e) Radar & Satellite (RAD/SAT)

3. The GFA will be continuously updated and available online at <http://new.aviationweather.gov/areafcst>. Upon clicking the link above, select INFO on the top right corner of the map display. The next screen presents the option of selecting Overview, Products, and Tutorial. Simply select the tab of interest to explore the enhanced digital and graphical weather products designed to replace the legacy FA. Users should also refer to AC 00-45, *Aviation*

Weather Services, for more detailed information on the GFA.

4. **GFA Static Images.** Some users with limited internet connectivity may access static images via the Aviation Weather Center (AWC) at: <http://www.aviationweather.gov/gfa/plot>. There are two static graphical images available, titled *Aviation Cloud Forecast* and *Aviation Surface Forecast*. The Aviation Cloud Forecast provides cloud coverage, bases, layers, and tops with Airmet Sierra for mountain obscuration and Airmet Zulu for icing overlaid. The Aviation Surface Forecast provides visibility, weather phenomena, and winds (including wind gusts) with Airmet Sierra for instrument flight rules conditions and Airmet Tango for sustained surface winds of 30 knots or more overlaid. These images are presented on ten separate maps providing forecast views for the entire CONUS on one and nine regional views which provide more detail for the user. They are updated every 3 hours and provide forecast snapshots for 3, 6, 9, 12, 15, and 18 hours into the future. (See FIG 7-1-2 and FIG 7-1-3.)

FIG 7-1-2
Aviation Surface Forecast

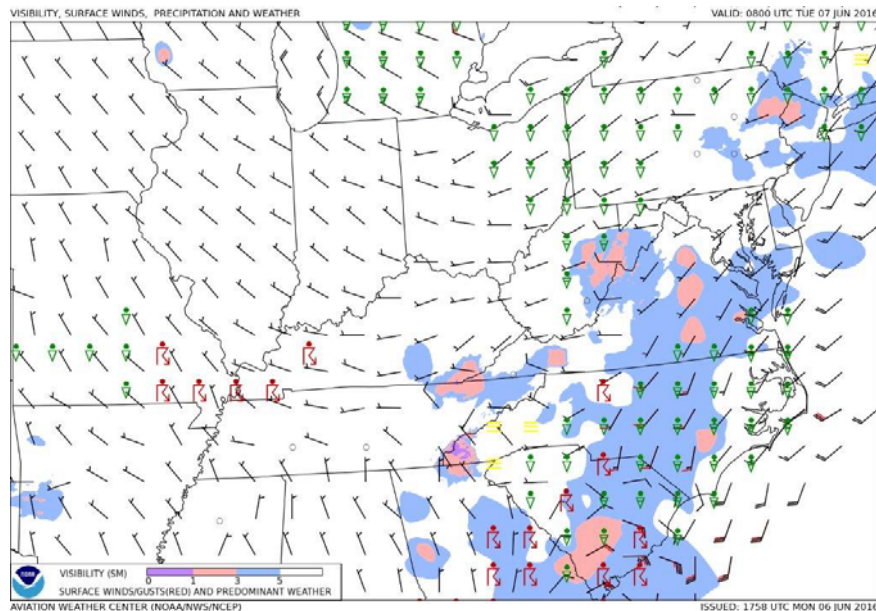
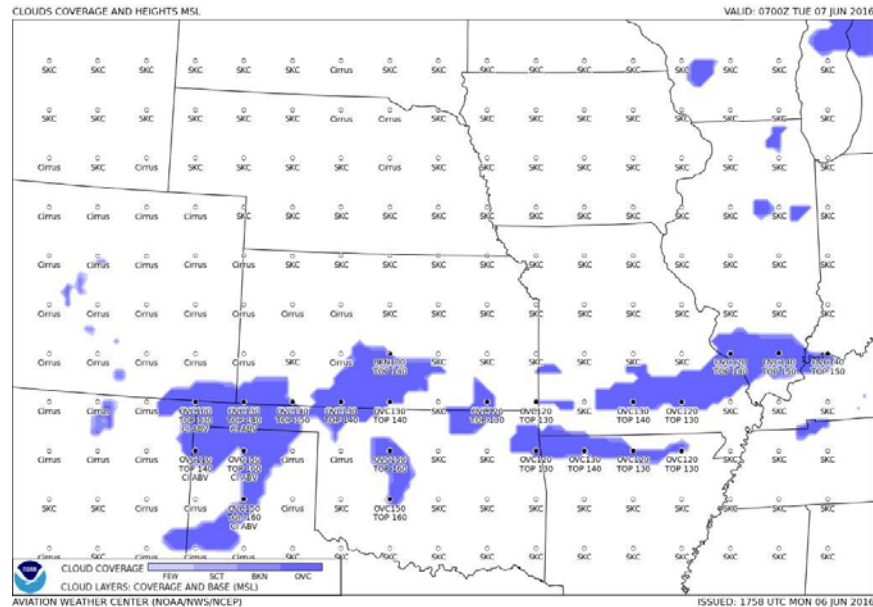

FIG 7-1-3
Aviation Cloud Forecast



7-1-5. Preflight Briefing

a. Flight Service Stations (FSS) are the primary sources for obtaining preflight briefings and to file flight plans by phone or the Internet. Flight Service Specialists are qualified and certified as Pilot Weather Briefers by the FAA. They are not authorized to make original forecasts, but are authorized to translate and interpret available forecasts and reports directly into terms describing the weather conditions which can be expected along the flight route and at the destination. Three basic types of preflight briefings (Standard, Abbreviated, and Outlook) are available to serve the pilot's specific needs. Pilots should specify to the briefer the type of briefing they want, along with their appropriate background information. This will enable the briefer to tailor the information to the pilot's intended flight. The following paragraphs describe the types of briefings available and the information provided in each briefing.

REFERENCE-

AIM, Paragraph 5-1-1, *Preflight Preparation*, for items that are required.

b. **Standard Briefing.** You should request a Standard Briefing any time you are planning a flight and you have not received a previous briefing or have not received preliminary information through mass dissemination media; for example, in Alaska only, TIBS and TWEB. International data may be

inaccurate or incomplete. If you are planning a flight outside of U.S. controlled airspace, the briefer will advise you to check data as soon as practical after entering foreign airspace, unless you advise that you have the international cautionary advisory. The briefer will automatically provide the following information in the sequence listed, except as noted, when it is applicable to your proposed flight.

1. Adverse Conditions. Significant meteorological and/or aeronautical information that might influence the pilot to alter or cancel the proposed flight; for example, hazardous weather conditions, airport closures, air traffic delays, etc. Pilots should be especially alert for current or forecast weather that could reduce flight minimums below VFR or IFR conditions. Pilots should also be alert for any reported or forecast icing if the aircraft is not certified for operating in icing conditions. Flying into areas of icing or weather below minimums could have disastrous results.

2. VFR Flight Not Recommended. When VFR flight is proposed and sky conditions or visibilities are present or forecast, surface or aloft, that, in the briefer's judgment, would make flight under VFR doubtful, the briefer will describe the conditions, describe the affected locations, and use the phrase "*VFR flight not recommended.*" This

recommendation is advisory in nature. The final decision as to whether the flight can be conducted safely rests solely with the pilot. Upon receiving a “VFR flight not recommended” statement, the non-IFR rated pilot will need to make a “go or no go” decision. This decision should be based on weighing the current and forecast weather conditions against the pilot’s experience and ratings. The aircraft’s equipment, capabilities and limitations should also be considered.

NOTE–

Pilots flying into areas of minimal VFR weather could encounter unforecasted lowering conditions that place the aircraft outside the pilot’s ratings and experience level. This could result in spatial disorientation and/or loss of control of the aircraft.

3. Synopsis. A brief statement describing the type, location and movement of weather systems and/or air masses which might affect the proposed flight.

NOTE–

These first 3 elements of a briefing may be combined in any order when the briefer believes it will help to more clearly describe conditions.

4. Current Conditions. Reported weather conditions applicable to the flight will be summarized from all available sources; e.g., METARs/ SPECIs, PIREPs, RAREPs. This element will be omitted if the proposed time of departure is beyond 2 hours, unless the information is specifically requested by the pilot.

5. En Route Forecast. Forecast en route conditions for the proposed route are summarized in logical order; i.e., departure/climbout, en route, and descent. (Heights are MSL, unless the contractions “AGL” or “CIG” are denoted indicating that heights are above ground.)

6. Destination Forecast. The destination forecast for the planned ETA. Any significant changes within 1 hour before and after the planned arrival are included.

7. Winds Aloft. Forecast winds aloft will be provided using degrees of the compass. The briefer will interpolate wind directions and speeds between levels and stations as necessary to provide expected conditions at planned altitudes. (Heights are MSL.) Temperature information will be provided on request.

8. Notices to Airmen (NOTAMs).

(a) Available NOTAM (D) information pertinent to the proposed flight, including special use airspace (SUA) NOTAMs for restricted areas, aerial refueling, and night vision goggles (NVG).

NOTE–

Other SUA NOTAMs (D), such as military operations area (MOA), military training route (MTR), and warning area NOTAMs, are considered “upon request” briefing items as indicated in paragraph 7–1–4b10(a).

(b) Prohibited Areas P–40, P–49, P–56, and the special flight rules area (SFRA) for Washington, DC.

(c) FSS briefers do not provide FDC NOTAM information for special instrument approach procedures unless specifically asked. Pilots authorized by the FAA to use special instrument approach procedures must specifically request FDC NOTAM information for these procedures.

NOTE–

1. *NOTAM information may be combined with current conditions when the briefer believes it is logical to do so.*

2. *Airway NOTAMs, procedural NOTAMs, and NOTAMs that are general in nature and not tied to a specific airport/facility (for example, flight advisories and restrictions, open duration special security instructions, and special flight rules areas) are briefed solely by pilot request. NOTAMs, graphic notices, and other information published in the NTAP are not included in pilot briefings unless the pilot specifically requests a review of this publication. For complete flight information, pilots are urged to review the printed information in the NTAP and the Chart Supplement U.S. In addition to obtaining a briefing.*

9. ATC Delays. Any known ATC delays and flow control advisories which might affect the proposed flight.

10. Pilots may obtain the following from flight service station briefers upon request:

(a) Information on SUA and SUA-related airspace, except those listed in paragraph 7–1–4b8.

NOTE–

1. *For the purpose of this paragraph, SUA and related airspace includes the following types of airspace: alert area, military operations area (MOA), warning area, and air traffic control assigned airspace (ATCAA). MTR data includes the following types of airspace: IFR training routes (IR), VFR training routes (VR), and slow training routes (SR).*

2. *Pilots are encouraged to request updated information from ATC facilities while in flight.*

(b) A review of airway NOTAMs, procedural NOTAMs, and NOTAMs that are general in nature and not tied to a specific airport/facility (for example, flight advisories and restrictions, open duration special security instructions, and special flight rules areas), graphic notices, and other information published in the NTAP.

(c) Approximate density altitude data.

(d) Information regarding such items as air traffic services and rules, customs/immigration procedures, ADIZ rules, search and rescue, etc.

(e) GPS RAIM availability for 1 hour before to 1 hour after ETA or a time specified by the pilot.

(f) Other assistance as required.

c. Abbreviated Briefing. Request an Abbreviated Briefing when you need information to supplement mass disseminated data, update a previous briefing, or when you need only one or two specific items. Provide the briefer with appropriate background information, the time you received the previous information, and/or the specific items needed. You should indicate the source of the information already received so that the briefer can limit the briefing to the information that you have not received, and/or appreciable changes in meteorological/aeronautical conditions since your previous briefing. To the extent possible, the briefer will provide the information in the sequence shown for a Standard Briefing. If you request only one or two specific items, the briefer will advise you if adverse conditions are present or forecast. (Adverse conditions contain both meteorological and/or aeronautical information.) Details on these conditions will be provided at your request. International data may be inaccurate or incomplete. If you are planning a flight outside of U.S. controlled airspace, the briefer will advise you to check data as soon as practical after entering foreign airspace, unless you advise that you have the international cautionary advisory.

d. Outlook Briefing. You should request an Outlook Briefing whenever your proposed time of departure is six or more hours from the time of the briefing. The briefer will provide available forecast data applicable to the proposed flight. This type of briefing is provided for planning purposes only. You should obtain a Standard or Abbreviated Briefing prior to departure in order to obtain such items as

adverse conditions, current conditions, updated forecasts, winds aloft and NOTAMs, etc.

e. When filing a flight plan only, you will be asked if you require the latest information on adverse conditions pertinent to the route of flight.

f. Inflight Briefing. You are encouraged to obtain your preflight briefing by telephone or in person before departure. In those cases where you need to obtain a preflight briefing or an update to a previous briefing by radio, you should contact the nearest FSS to obtain this information. After communications have been established, advise the specialist of the type briefing you require and provide appropriate background information. You will be provided information as specified in the above paragraphs, depending on the type of briefing requested. En Route advisories tailored to the phase of flight that begins after climb-out and ends with descent to land are provided upon pilot request. Pilots are encouraged to provide a continuous exchange of information on weather, winds, turbulence, flight visibility, icing, etc., between pilots and inflight specialists. Pilots should report good weather as well as bad, and confirm expected conditions as well as unexpected. Remember that weather conditions can change rapidly and that a “go or no go” decision, as mentioned in paragraph 7-1-4b2, should be assessed at all phases of flight.

g. Following any briefing, feel free to ask for any information that you or the briefer may have missed or are not understood. This way, the briefer is able to present the information in a logical sequence, and lessens the chance of important items being overlooked.

7-1-6. Inflight Aviation Weather Advisories

a. Background

1. Inflight Aviation Weather Advisories are forecasts to advise en route aircraft of development of potentially hazardous weather. Inflight aviation weather advisories in the conterminous U.S. are issued by the Aviation Weather Center (AWC) in Kansas City, MO, as well as 20 Center Weather Service Units (CWSU) associated with ARTCCs. AWC also issues advisories for portions of the Gulf of Mexico, Atlantic and Pacific Oceans, which are under the control of ARTCCs with Oceanic flight information regions (FIRs). The Weather Forecast Office (WFO) in Honolulu issues advisories for the

Hawaiian Islands and a large portion of the Pacific Ocean. In Alaska, the Alaska Aviation Weather Unit (AAWU) issues inflight aviation weather advisories along with the Anchorage CWSU. All heights are referenced MSL, except in the case of ceilings (CIG) which indicate AGL.

2. There are four types of inflight aviation weather advisories: the SIGMET, the Convective SIGMET, the AIRMET (text or graphical product), and the Center Weather Advisory (CWA). All of these advisories use the same location identifiers (either VORs, airports, or well-known geographic areas) to describe the hazardous weather areas.

3. The Severe Weather Watch Bulletins (WWs), (with associated Alert Messages) (AWW) supplements these Inflight Aviation Weather Advisories.

b. SIGMET (WS)/AIRMET (WA or G-AIRMET)

SIGMETs/AIRMET text (WA) products are issued corresponding to the Area Forecast (FA) areas described in FIG 7-1-4 and FIG 7-1-5. The maximum forecast period is 4 hours for SIGMETs and 6 hours for AIRMETs. The G-AIRMET is issued over the CONUS every 6 hours, valid at 3-hour increments through 12 hours with optional forecasts possible during the first 6 hours. The first 6 hours of the G-AIRMET correspond to the 6-hour period of the AIRMET. SIGMETs and AIRMETs are considered “widespread” because they must be either affecting or be forecasted to affect an area of at least 3,000 square miles at any one time. However, if the total area to be affected during the forecast period is very large, it could be that in actuality only a small portion of this total area would be affected at any one time.

1. SIGMETs/AIRMET (or G-AIRMET) for the conterminous U.S. (CONUS)

SIGMETs/AIRMET text products for the CONUS are issued corresponding to the areas in FIG 7-1-4. The maximum forecast period for a CONUS SIGMET is 4 hours and 6 hours for CONUS AIRMETs. The G-AIRMET is issued over the CONUS every 6 hours, valid at 3-hour increments through 12 hours with optional forecasts possible during the first 6 hours. The first 6 hours of the G-AIRMET correspond to the 6-hour period of the AIRMET. SIGMETs and AIRMETs are considered “widespread” because they must be either affecting

or be forecasted to affect an area of at least 3,000 square miles at any one time. However, if the total area to be affected during the forecast period is very large, it could be that in actuality only a small portion of this total area would be affected at any one time. Only SIGMETs for the CONUS are for non-convective weather. The U.S. issues a special category of SIGMETs for convective weather called Convective SIGMETs.

2. SIGMETs/AIRMETs for Alaska

Alaska SIGMETs are valid for up to 4 hours, except for Volcanic Ash Cloud SIGMETs which are valid for up to 6 hours. Alaska AIRMETs are valid for up to 8 hours.

3. SIGMETs/AIRMETs for Hawaii and U.S. FIRs in the Gulf of Mexico, Caribbean, Western Atlantic and Eastern and Central Pacific Oceans

These SIGMETs are valid for up to 4 hours, except SIGMETs for Tropical Cyclones and Volcanic Ash Clouds, which are valid for up to 6 hours. AIRMETs are issued for the Hawaiian Islands and are valid for up to 6 hours. No AIRMETs are issued for U.S. FIRs in the the Gulf of Mexico, Caribbean, Western Atlantic and Pacific Oceans.

c. SIGMET

A SIGMET advises of weather that is potentially hazardous to all aircraft. SIGMETs are unscheduled products that are valid for 4 hours. However, SIGMETs associated with tropical cyclones and volcanic ash clouds are valid for 6 hours. Unscheduled updates and corrections are issued as necessary.

1. In the CONUS, SIGMETs are issued when the following phenomena occur or are expected to occur:

(a) Severe icing not associated with thunderstorms.

(b) Severe or extreme turbulence or clear air turbulence (CAT) not associated with thunderstorms.

(c) Widespread dust storms or sandstorms lowering surface visibilities to below 3 miles.

(d) Volcanic ash.

2. In Alaska and Hawaii, SIGMETs are also issued for:

(a) Tornadoes.

- (b) Lines of thunderstorms.
- (c) Embedded thunderstorms.
- (d) Hail greater than or equal to $\frac{3}{4}$ inch in diameter.

3. SIGMETs are identified by an alphabetic designator from November through Yankee excluding Sierra and Tango. (Sierra, Tango, and Zulu are reserved for AIRMET text [WA] products; G-AIRMETS do not use the Sierra, Tango, or Zulu designators.) The first issuance of a SIGMET will be labeled as UWS (Urgent Weather SIGMET). Subsequent issuances are at the forecaster's discretion. Issuance for the same phenomenon will be sequentially numbered, using the original designator until the phenomenon ends. For example, the first issuance in the Chicago (CHI) FA area for phenomenon moving from the Salt Lake City (SLC) FA area will be SIGMET Papa 3, if the previous two issuances, Papa 1 and Papa 2, had been in the SLC FA area. Note that no two different phenomena across the country can have the same alphabetic designator at the same time.

EXAMPLE–

Example of a SIGMET:

BOSR WS 050600

SIGMET ROMEO 2 VALID UNTIL 051000

ME NH VT

FROM CAR TO YSJ TO CON TO MPV TO CAR

OCNL SEV TURB BLW 080 EXP DUE TO STG NWLY

FLOW. CONDS CONTG BYD 1000Z.

d. Convective SIGMET (WST)

1. Convective SIGMETs are issued in the conterminous U.S. for any of the following:

- (a) Severe thunderstorm due to:
 - (1) Surface winds greater than or equal to 50 knots.
 - (2) Hail at the surface greater than or equal to $\frac{3}{4}$ inches in diameter.
 - (3) Tornadoes.
- (b) Embedded thunderstorms.

- (c) A line of thunderstorms.

(d) Thunderstorms producing precipitation greater than or equal to heavy precipitation affecting 40 percent or more of an area at least 3,000 square miles.

2. Any convective SIGMET implies severe or greater turbulence, severe icing, and low-level wind shear. A convective SIGMET may be issued for any convective situation that the forecaster feels is hazardous to all categories of aircraft.

3. Convective SIGMET bulletins are issued for the western (W), central (C), and eastern (E) United States. (Convective SIGMETs are not issued for Alaska or Hawaii.) The areas are separated at 87 and 107 degrees west longitude with sufficient overlap to cover most cases when the phenomenon crosses the boundaries. Bulletins are issued hourly at H+55. Special bulletins are issued at any time as required and updated at H+55. If no criteria meeting convective SIGMET requirements are observed or forecasted, the message "CONVECTIVE SIGMET... NONE" will be issued for each area at H+55. Individual convective SIGMETs for each area (W, C, E) are numbered sequentially from number one each day, beginning at 00Z. A convective SIGMET for a continuing phenomenon will be reissued every hour at H+55 with a new number. The text of the bulletin consists of either an observation and a forecast or just a forecast. The forecast is valid for up to 2 hours.

EXAMPLE–

CONVECTIVE SIGMET 44C

VALID UNTIL 1455Z

AR TX OK

FROM 40NE ADM-40ESE MLC-10W TXK-50WNW

LFK-40ENE SJT-40NE ADM

AREA TS MOV FROM 26025KT. TOPS ABV FL450.

OUTLOOK VALID 061455-061855

FROM 60WSW OKC-MLC-40N TXK-40WSW

IGB-VUZ-MGM-HRV-60S BTR-40N

IAH-60SW SJT-40ENE LBB-60WSW OKC

WST ISSUANCES EXPD. REFER TO MOST RECENT

ACUS01 KWNS FROM STORM PREDICTION CENTER

FOR SYNOPSIS AND METEOROLOGICAL DETAILS

FIG 7-1-4
SIGMET and AIRMET Locations – Conterminous United States

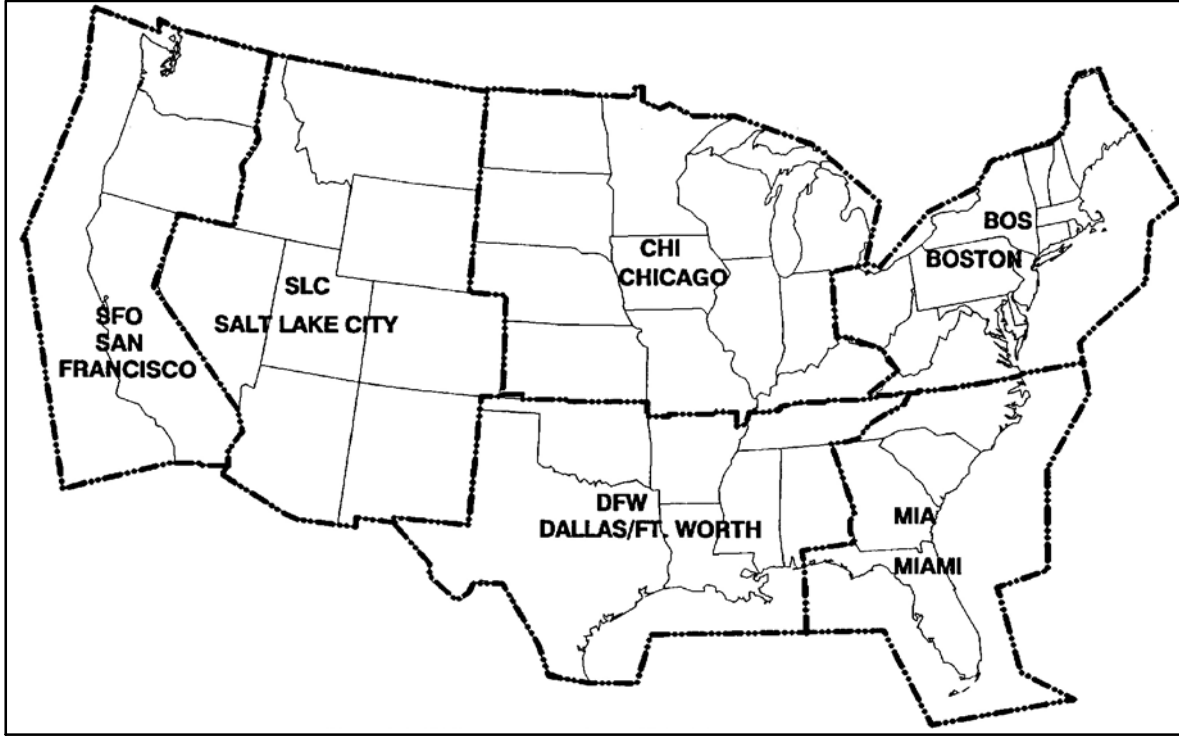
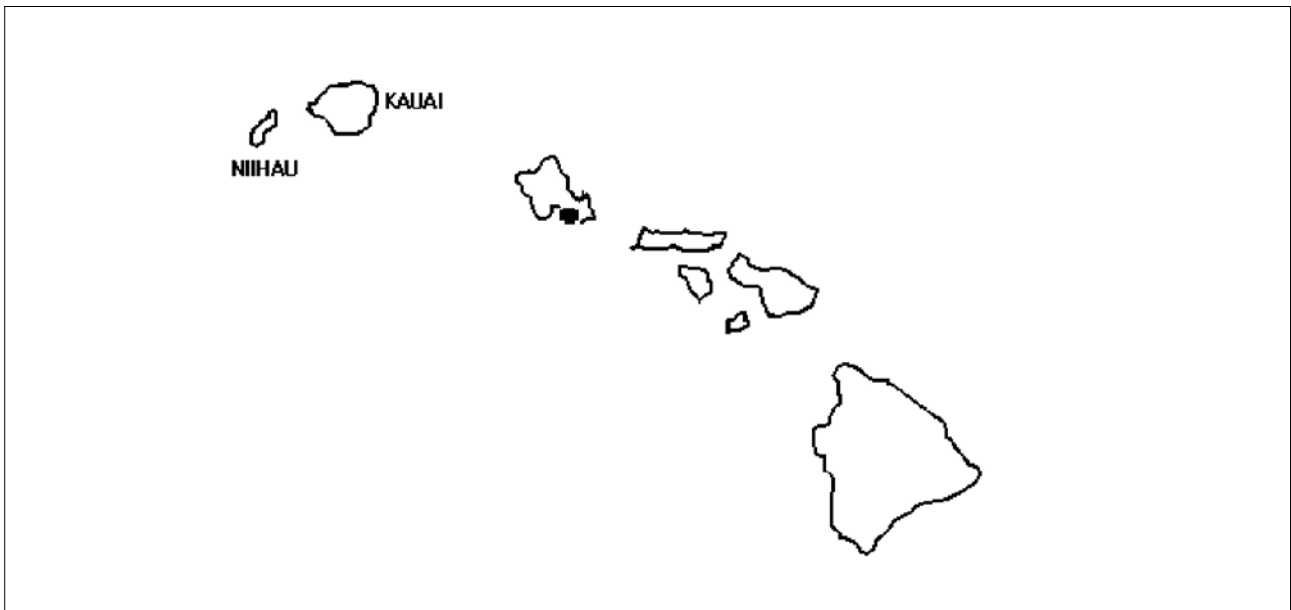

FIG 7-1-5
Hawaii Area Forecast Locations



e. SIGMET Outside the CONUS

1. Three NWS offices have been designated by ICAO as Meteorological Watch Offices (MWOs). These offices are responsible for issuing SIGMETs for designated areas outside the CONUS that include Alaska, Hawaii, portions of the Atlantic and Pacific Oceans, and the Gulf of Mexico.

2. The offices which issue international SIGMETs are:

- (a) The AWC in Kansas City, Missouri.
- (b) The AAWU in Anchorage, Alaska.
- (c) The WFO in Honolulu, Hawaii.

3. SIGMETs for outside the CONUS are issued for 6 hours for volcanic ash clouds, 6 hours for tropical cyclones (e.g. hurricanes and tropical storms), and 4 hours for all other events. Like the CONUS SIGMETs, SIGMETs for outside the CONUS are also identified by an alphabetic designator from Alpha through Mike and are numbered sequentially until that weather phenomenon ends. The criteria for an international SIGMET are:

- (a) Thunderstorms occurring in lines, embedded in clouds, or in large areas producing tornadoes or large hail.
- (b) Tropical cyclones.
- (c) Severe icing.
- (d) Severe or extreme turbulence.
- (e) Dust storms and sandstorms lowering visibilities to less than 3 miles.
- (f) Volcanic ash.

EXAMPLE–

Example of SIGMET Outside the U.S.:

WSNT06 KKCI 022014

SIGA0F

KZMA KZNY TJZS SIGMET FOXTROT 3 VALID 022015/030015 KKCI– MIAMI OCEANIC FIR NEW YORK OCEANIC FIR SAN JUAN FIR FRQ TS WI AREA BOUNDED BY 2711N6807W 2156N6654W 2220N7040W 2602N7208W 2711N6807W. TOPS TO FL470. MOV NE 15KT. WKN. BASED ON SAT AND LTG OBS. MOSHER

f. AIRMET

1. AIRMETs (WAs) are advisories of significant weather phenomena but describe conditions at

intensities lower than those which require the issuance of SIGMETs. AIRMETs are intended for dissemination to all pilots in the preflight and en route phase of flight to enhance safety. AIRMET information is available in two formats: text bulletins (WA) and graphics (G–AIRMET). Both formats meet the criteria of paragraph 7–1–3i and are issued on a scheduled basis every 6 hours beginning at 0245 UTC. Unscheduled updates and corrections are issued as necessary. AIRMETs contain details about IFR, extensive mountain obscuration, turbulence, strong surface winds, icing, and freezing levels.

2. There are three AIRMETs: Sierra, Tango, and Zulu. After the first issuance each day, scheduled or unscheduled bulletins are numbered sequentially for easier identification.

(a) AIRMET Sierra describes IFR conditions and/or extensive mountain obscurations.

(b) AIRMET Tango describes moderate turbulence, sustained surface winds of 30 knots or greater, and/or nonconvective low–level wind shear.

(c) AIRMET Zulu describes moderate icing and provides freezing level heights.

EXAMPLE–

Example of AIRMET Sierra issued for the Chicago FA area:

CHIS WA 131445

AIRMET SIERRA UPDT 2 FOR IFR AND MTN OBSCN VALID UNTIL 132100.

AIRMET IFR...KY

FROM 20SSW HNN TO HMV TO 50ENE DYR TO 20SSW HNN

CIG BLW 010/VIS BLW 3SM PCPN/BR/FG. CONDS ENDG BY 18Z.

.

AIRMET IFR...MN LS

FROM INL TO 70W YQT TO 40ENE DLH TO

30WNW DLH TO 50SE GFK TO 20 ENE GFK TO

INL

CIG BLW 010/VIS BLW 3SM BR. CONDS ENDG 15–18Z.

.

AIRMET IFR...KS

FROM 30N SLN TO 60E ICT TO 40S ICT TO 50W

LBL TO 30SSW GLD TO 30N SLN

CIG BLW 010/VIS BLW 3SM PCPN/BR/FG. CONDS

ENDG 15–18Z.

.

AIRMET MTN OBSCN...KY TN

FROM HNN TO HMV TO GQO TO LOZ TO HNN

MTN OBSC BY CLDS/PCPN/BR. CONDS CONTG

BYD 21Z THRU 03Z.

.....

EXAMPLE-

Example of AIRMET Tango issued for the Salt Lake City FA area:

SLCT WA 131445

AIRMET TANGO UPDT 2 FOR TURB VALID UNTIL 132100.

AIRMET TURB...MT

FROM 40NW HVR TO 50SE BIL TO 60E DLN TO 60SW YQL TO 40NW HVR
MOD TURB BLW 150. CONDS DVLPG 18-21Z.
CONDS CONTG BYD 21Z THRU 03Z.

AIRMET TURB...ID MT WY NV UT CO

FROM 100SE MLS TO 50SSW BFF TO 20SW BTY TO 40SW BAM TO 100SE MLS
MOD TURB BTN FL310 AND FL410. CONDS
CONTG BYD 21Z ENDG 21-00Z.

AIRMET TURB...NV AZ NM CA AND CSTL WTRS
FROM 100WSW ENI TO 40W BTY TO 40S LAS TO 30ESE TBE TO INK TO ELP TO 50S TUS TO BZA TO 20S MZB TO 150SW PYE TO 100WSW ENI
MOD TURB BTWN FL210 AND FL380. CONDS
CONTG BYD 21Z THRU 03Z.

.....

EXAMPLE-

Example of AIRMET Zulu issued for the San Francisco FA area:

SFOZ WA 131445

AIRMET ZULU UPDT 2 FOR ICE AND FRZLVL VALID UNTIL 132100.

NO SGFNT ICE EXP OUTSIDE OF CNVTV ACT.

FRZLVL....RANGING FROM SFC-105 ACRS AREA
MULT FRZLVL BLW 080 BOUNDED BY 40SE
YDC-60NNW GEG-60SW MLP-30WSW BKE-
20SW BAM-70W BAM-40SW YKM-40E HUH-
40SE YDC
SFC ALG 20NNW HUH-30SSE HUH-60S SEA
50NW LKV-60WNWOAL-30SW OAL
040 ALG 40W HUH-30W HUH-30NNW SEA-40N
PDX-20NNW DSD
080 ALG 160NW FOT-80SW ONP-50SSW EUG
40SSE OED-50SSE CZQ-60E EHF-40WSW LAS

.....

3. Graphical AIRMETs (G-AIRMETs), found on the Aviation Weather Center webpage at <http://aviationweather.gov>, are graphical forecasts of en-route weather hazards valid at discrete times no more than 3 hours apart for a period of up to 12 hours into the future (for example, 00, 03, 06, 09, and 12 hours). Additional forecasts may be inserted during

the first 6 hours (for example, 01, 02, 04, and 05). 00 hour represents the initial conditions, and the subsequent graphics depict the area affected by the particular hazard at that valid time. Forecasts valid at 00 through 06 hours correspond to the text AIRMET bulletin. Forecasts valid at 06 through 12 hours correspond to the text bulletin outlook. G-AIRMET depicts the following en route aviation weather hazards:

- (a) Instrument flight rule conditions (ceiling < 1000' and/or surface visibility <3 miles)
- (b) Mountain obscuration
- (c) Icing
- (d) Freezing level
- (e) Turbulence
- (f) Low level wind shear (LLWS)
- (g) Strong surface winds

G-AIRMETs are snap shots at discrete time intervals as defined above. The text AIRMET is the result of the production of the G-AIRMET but provided in a time smear for a 6hr valid period. G-AIRMETs provide a higher forecast resolution than text AIRMET products. Since G-AIRMETs and text AIRMETs are created from the same forecast "production" process, there exists perfect consistency between the two. Using the two together will provide clarity of the area impacted by the weather hazard and improve situational awareness and decision making.

Interpolation of time periods between G-AIRMET valid times: Users must keep in mind when using the G-AIRMET that if a 00 hour forecast shows no significant weather and a 03 hour forecast shows hazardous weather, they must assume a change is occurring during the period between the two forecasts. It should be taken into consideration that the hazardous weather starts immediately after the 00 hour forecast unless there is a defined initiation or ending time for the hazardous weather. The same would apply after the 03 hour forecast. The user should assume the hazardous weather condition is occurring between the snap shots unless informed otherwise. For example, if a 00 hour forecast shows no hazard, a 03 hour forecast shows the presence of hazardous weather, and a 06 hour forecast shows no hazard, the user should assume the hazard exists from the 0001 hour to the 0559 hour time period.

EXAMPLE–

See FIG 7–1–6 for an example of the G–AIRMET graphical product.

g. Watch Notification Messages

The Storm Prediction Center (SPC) in Norman, OK, issues Watch Notification Messages to provide an area threat alert for forecast organized severe thunderstorms that may produce tornadoes, large hail, and/or convective damaging winds within the CONUS. SPC issues three types of watch notification messages: Aviation Watch Notification Messages, Public Severe Thunderstorm Watch Notification Messages, and Public Tornado Watch Notification Messages.

It is important to note the difference between a Severe Thunderstorm (or Tornado) Watch and a Severe Thunderstorm (or Tornado) Warning. A watch means severe weather is possible during the next few hours, while a warning means that severe weather has been observed, or is expected within the hour. Only the SPC issues Severe Thunderstorm and Tornado Watches, while only NWS Weather Forecasts Offices issue Severe Thunderstorm and Tornado Warnings.

1. The Aviation Watch Notification Message.

The Aviation Watch Notification Message product is an approximation of the area of the Public Severe Thunderstorm Watch or Public Tornado Watch. The area may be defined as a rectangle or parallelogram using VOR navigational aides as coordinates.

The Aviation Watch Notification Message was formerly known as the Alert Severe Weather Watch Bulletin (AWW). The NWS no longer uses that title or acronym for this product. The NWS uses the acronym SAW for the Aviation Watch Notification Message, but retains AWW in the product header for processing by weather data systems.

EXAMPLE–

Example of an Aviation Watch Notification Message:

WWUS30 KWNS 271559

SAW2

SPC AWW 271559

WW 568 TORNADO AR LA MS 271605Z - 280000Z

AXIS..65 STATUTE MILES EAST AND WEST OF LINE..

45ESE HEZ/NATCHEZ MS/ - 50N TUP/TUPELO MS/

..AVIATION COORDS.. 55NM E/W /18WNW MCB - 60E MEM/

HAIL SURFACE AND ALOFT..3 INCHES. WIND GUSTS..70 KNOTS. MAX TOPS TO 550. MEAN STORM MOTION VECTOR 26030.

LAT...LON 31369169 34998991 34998762 31368948

THIS IS AN APPROXIMATION TO THE WATCH AREA. FOR A COMPLETE DEPICTION OF THE WATCH SEE WOUS64 KWNS FOR WOU2.

2. Public Severe Thunderstorm Watch Notification Messages describe areas of expected severe thunderstorms. (Severe thunderstorm criteria are 1-inch hail or larger and/or wind gusts of 50 knots [58 mph] or greater). A Public Severe Thunderstorm Watch Notification Message contains the area description and axis, the watch expiration time, a description of hail size and thunderstorm wind gusts expected, the definition of the watch, a call to action statement, a list of other valid watches, a brief discussion of meteorological reasoning and technical information for the aviation community.

3. Public Tornado Watch Notification Messages describe areas where the threat of tornadoes exists. A Public Tornado Watch Notification Message contains the area description and axis, watch expiration time, the term “damaging tornadoes,” a description of the largest hail size and strongest thunderstorm wind gusts expected, the definition of the watch, a call to action statement, a list of other valid watches, a brief discussion of meteorological reasoning and technical information for the aviation community. SPC may enhance a Public Tornado Watch Notification Message by using the words “THIS IS A PARTICULARLY DANGEROUS SITUATION” when there is a likelihood of multiple strong (damage of EF2 or EF3) or violent (damage of EF4 or EF5) tornadoes.

4. Public severe thunderstorm and tornado watch notification messages were formerly known as the Severe Weather Watch Bulletins (WW). The NWS no longer uses that title or acronym for this product but retains WW in the product header for processing by weather data systems.

EXAMPLE–

Example of a Public Tornado Watch Notification Message:

WWUS20 KWNS 050550

SEL2

SPC WW 051750

URGENT - IMMEDIATE BROADCAST REQUESTED

TORNADO WATCH NUMBER 243

NWS STORM PREDICTION CENTER NORMAN OK

1250 AM CDT MON MAY 5 2011

THE NWS STORM PREDICTION CENTER HAS ISSUED

A

*TORNADO WATCH FOR PORTIONS OF WESTERN AND CENTRAL ARKANSAS

*SOUTHERN MISSOURI
 FAR EASTERN OKLAHOMA
 *EFFECTIVE THIS MONDAY MORNING FROM 1250
 AM UNTIL 600 AM CDT.
 ...THIS IS A PARTICULARLY DANGEROUS SITUATION...
 *PRIMARY THREATS INCLUDE
 NUMEROUS INTENSE TORNADOES LIKELY
 NUMEROUS SIGNIFICANT DAMAGING WIND GUSTS
 TO 80 MPH LIKELY
 NUMEROUS VERY LARGE HAIL TO 4 INCHES IN
 DIAMETER LIKELY
 THE TORNADO WATCH AREA IS APPROXIMATELY
 ALONG AND 100 STATUTE MILES EAST AND WEST OF
 A LINE FROM 15 MILES WEST NORTHWEST OF FORT
 LEONARD WOOD MISSOURI TO 45 MILES SOUTH-
 WEST OF HOT SPRINGS ARKANSAS. FOR A
 COMPLETE DEPICTION OF THE WATCH SEE THE
 ASSOCIATED WATCH OUTLINE UPDATE (WOUS64
 KWNS WOU2).
 REMEMBER...A TORNADO WATCH MEANS CONDI-
 TIONS ARE FAVORABLE FOR TORNADOES AND
 SEVERE THUNDERSTORMS IN AND CLOSE TO THE
 WATCH AREA. PERSONS IN THESE AREAS SHOULD
 BE ON THE LOOKOUT FOR THREATENING WEATH-
 ER CONDITIONS AND LISTEN FOR LATER
 STATEMENTS AND POSSIBLE WARNINGS.
 OTHER WATCH INFORMATION...THIS TORNADO
 WATCH REPLACES TORNADO WATCH NUMBER 237.
 WATCH NUMBER 237 WILL NOT BE IN EFFECT
 AFTER
 1250 AM CDT. CONTINUE...WW 239...WW 240...WW
 241...WW 242...
 DISCUSSION...SRN MO SQUALL LINE EXPECTED TO
 CONTINUE EWD...WHERE LONG/HOOKED
 HODOGRAPHS SUGGEST THREAT FOR EMBEDDED
 SUPERCELLS/POSSIBLE TORNADOES. FARTHER
 S...MORE WIDELY SCATTERED
 SUPERCELLS WITH A THREAT FOR TORNADOES
 WILL PERSIST IN VERY STRONGLY DEEP SHEARED/
 LCL ENVIRONMENT IN AR.
 AVIATION...TORNADOES AND A FEW SEVERE THUN-
 DERSTORMS WITH HAIL SURFACE AND ALOFT TO 4
 INCHES. EXTREME TURBULENCE AND SURFACE
 WIND GUSTS TO 70 KNOTS. A FEW CUMULONIMBI
 WITH MAXIMUM TOPS TO 500. MEAN STORM
 MOTION VECTOR 26045.*

5. Status reports are issued as needed to show progress of storms and to delineate areas no longer under the threat of severe storm activity. Cancellation bulletins are issued when it becomes evident that no severe weather will develop or that storms have subsided and are no longer severe.

h. Center Weather Advisories (CWAs)

1. CWAs are unscheduled inflight, flow control, air traffic, and air crew advisory. By nature of its short lead time, the CWA is not a flight planning product. It is generally a nowcast for conditions beginning within the next two hours. CWAs will be issued:

(a) As a supplement to an existing SIGMET, Convective SIGMET or AIRMET.

(b) When an Inflight Advisory has not been issued but observed or expected weather conditions meet SIGMET/AIRMET criteria based on current pilot reports and reinforced by other sources of information about existing meteorological conditions.

(c) When observed or developing weather conditions do not meet SIGMET, Convective SIGMET, or AIRMET criteria; e.g., in terms of intensity or area coverage, but current pilot reports or other weather information sources indicate that existing or anticipated meteorological phenomena will adversely affect the safe flow of air traffic within the ARTCC area of responsibility.

2. The following example is a CWA issued from the Kansas City, Missouri, ARTCC. The “3” after ZKC in the first line denotes this CWA has been issued for the third weather phenomena to occur for the day. The “301” in the second line denotes the phenomena number again (3) and the issuance number (01) for this phenomena. The CWA was issued at 2140Z and is valid until 2340Z.

EXAMPLE-

ZKC3 CWA 032140

ZKC CWA 301 VALID UNTIL 032340

ISOLD SVR TSTM over KCOU MOVG SWWD
 10 KTS ETC.

7-1-7. Categorical Outlooks

a. Categorical outlook terms, describing general ceiling and visibility conditions for advanced planning purposes are used only in area forecasts and are defined as follows:

1. **LIFR (Low IFR).** Ceiling less than 500 feet and/or visibility less than 1 mile.

2. **IFR.** Ceiling 500 to less than 1,000 feet and/or visibility 1 to less than 3 miles.

3. **MVFR (Marginal VFR).** Ceiling 1,000 to 3,000 feet and/or visibility 3 to 5 miles inclusive.

4. VFR. Ceiling greater than 3,000 feet and visibility greater than 5 miles; includes sky clear.

b. The cause of LIFR, IFR, or MVFR is indicated by either ceiling or visibility restrictions or both. The contraction “CIG” and/or weather and obstruction to vision symbols are used. If winds or gusts of 25 knots or greater are forecast for the outlook period, the word “WIND” is also included for all categories including VFR.

EXAMPLE–

1. *LIFR CIG–low IFR due to low ceiling.*
2. *IFR FG–IFR due to visibility restricted by fog.*
3. *MVFR CIG HZ FU–marginal VFR due to both ceiling and visibility restricted by haze and smoke.*
4. *IFR CIG RA WIND–IFR due to both low ceiling and visibility restricted by rain; wind expected to be 25 knots or greater.*

7–1–8. Telephone Information Briefing Service (TIBS) (Alaska Only)

a. TIBS, provided by FSS, is a system of automated telephone recordings of meteorological and aeronautical information available in Alaska. Based on the specific needs of each area, TIBS provides route and/or area briefings in addition to airspace procedures and special announcements concerning aviation interests that may be available. Depending on user demand, other items may be provided; for example, surface weather observations, terminal forecasts, wind and temperatures aloft forecasts, etc.

b. TIBS is not intended to be a substitute for specialist–provided preflight briefings from FSS. TIBS is recommended as a preliminary briefing and often will be valuable in helping you to make a “go” or “no go” decision.

c. Pilots are encouraged to utilize TIBS, which can be accessed by dialing the FSS toll–free telephone number, 1–800–WX–BRIEF (992–7433) or specific published TIBS telephone numbers in certain areas. Consult the “FSS Telephone Numbers” section of the Chart Supplement U.S. or the Chart Supplement Alaska or Pacific.

NOTE–

A touch–tone telephone is necessary to fully utilize TIBS.

7–1–9. Transcribed Weather Broadcast (TWEB) (Alaska Only)

Equipment is provided in Alaska by which meteorological and aeronautical data are recorded on tapes and broadcast continuously over selected L/MF and VOR facilities. Broadcasts are made from a series of individual tape recordings, and changes, as they occur, are transcribed onto the tapes. The information provided varies depending on the type equipment available. Generally, the broadcast contains a summary of adverse conditions, surface weather observations, pilot weather reports, and a density altitude statement (if applicable). At the discretion of the broadcast facility, recordings may also include a synopsis, winds aloft forecast, en route and terminal forecast data, and radar reports. At selected locations, telephone access to the TWEB has been provided (TEL–TWEB). Telephone numbers for this service are found in the Chart Supplement Alaska. These broadcasts are made available primarily for preflight and inflight planning, and as such, should not be considered as a substitute for specialist–provided preflight briefings.

7–1–10. Inflight Weather Broadcasts

a. Weather Advisory Broadcasts. ARTCCs broadcast a Severe Weather Forecast Alert (AWW), Convective SIGMET, SIGMET, or CWA alert once on all frequencies, except emergency, when any part of the area described is within 150 miles of the airspace under their jurisdiction. These broadcasts contain SIGMET or CWA (identification) and a brief description of the weather activity and general area affected.

EXAMPLE–

1. *Attention all aircraft, SIGMET Delta Three, from Myton to Tuba City to Milford, severe turbulence and severe clear icing below one zero thousand feet. Expected to continue beyond zero three zero zero zulu.*
2. *Attention all aircraft, convective SIGMET Two Seven Eastern. From the vicinity of Elmira to Phillipsburg. Scattered embedded thunderstorms moving east at one zero knots. A few intense level five cells, maximum tops four five zero.*
3. *Attention all aircraft, Kansas City Center weather advisory one zero three. Numerous reports of moderate to severe icing from eight to nine thousand feet in a three zero mile radius of St. Louis. Light or negative icing reported from four thousand to one two thousand feet remainder of Kansas City Center area.*

NOTE—

1. Terminal control facilities have the option to limit the AWW, convective SIGMET, SIGMET, or CWA broadcast as follows: local control and approach control positions may opt to broadcast SIGMET or CWA alerts only when any part of the area described is within 50 miles of the airspace under their jurisdiction.

2. In areas where HIWAS is available, ARTCC, Terminal ATC, and FSS facilities no longer broadcast Inflight Weather Advisories as described above in paragraph a. See paragraphs b1 and b2 below.

b. Hazardous Inflight Weather Advisory Service (HIWAS). HIWAS is an automated, continuous broadcast of inflight weather advisories, provided by FSS over select VOR outlets, which include the following weather products: AWW, SIGMET, Convective SIGMET, CWA, AIRMET (text [WA] or graphical [G–AIRMET] products), and urgent PIREP. HIWAS is available throughout the conterminous United States as an additional source of hazardous weather information. HIWAS does not replace preflight or inflight weather briefings from FSS. Pilots should call FSS if there are any questions about weather that is different than forecasted or if the HIWAS broadcast appears to be in error.

1. Where HIWAS is available, ARTCC and terminal ATC facilities will broadcast, upon receipt,

a HIWAS alert once on all frequencies, except emergency frequencies. Included in the broadcast will be an alert announcement, frequency instruction, number, and type of advisory updated; for example, AWW, SIGMET, Convective SIGMET, or CWA.

EXAMPLE—

Attention all aircraft. Hazardous weather information (SIGMET, Convective SIGMET, AIRMET (text [WA] or graphical [G–AIRMET] product), Urgent Pilot Weather Report [UUA], or Center Weather Advisory [CWA], Number or Numbers) for (geographical area) available on HIWAS or Flight Service frequencies.

2. Upon notification of an update to HIWAS, FSS will broadcast a HIWAS update announcement once on all frequencies except emergency frequencies. Included in the broadcast will be the type of advisory updated; for example, AWW, SIGMET, Convective SIGMET, CWA, etc.

EXAMPLE—

Attention all aircraft. Hazardous weather information for (geographical area) available from Flight Service.

3. HIWAS availability is notated with VOR listings in the Chart Supplement U.S., and is shown by symbols on IFR Enroute Low Altitude Charts and VFR Sectional Charts. The symbol depiction is identified in the chart legend.

FIG 7-1-6
G-AIRMET Graphical Product

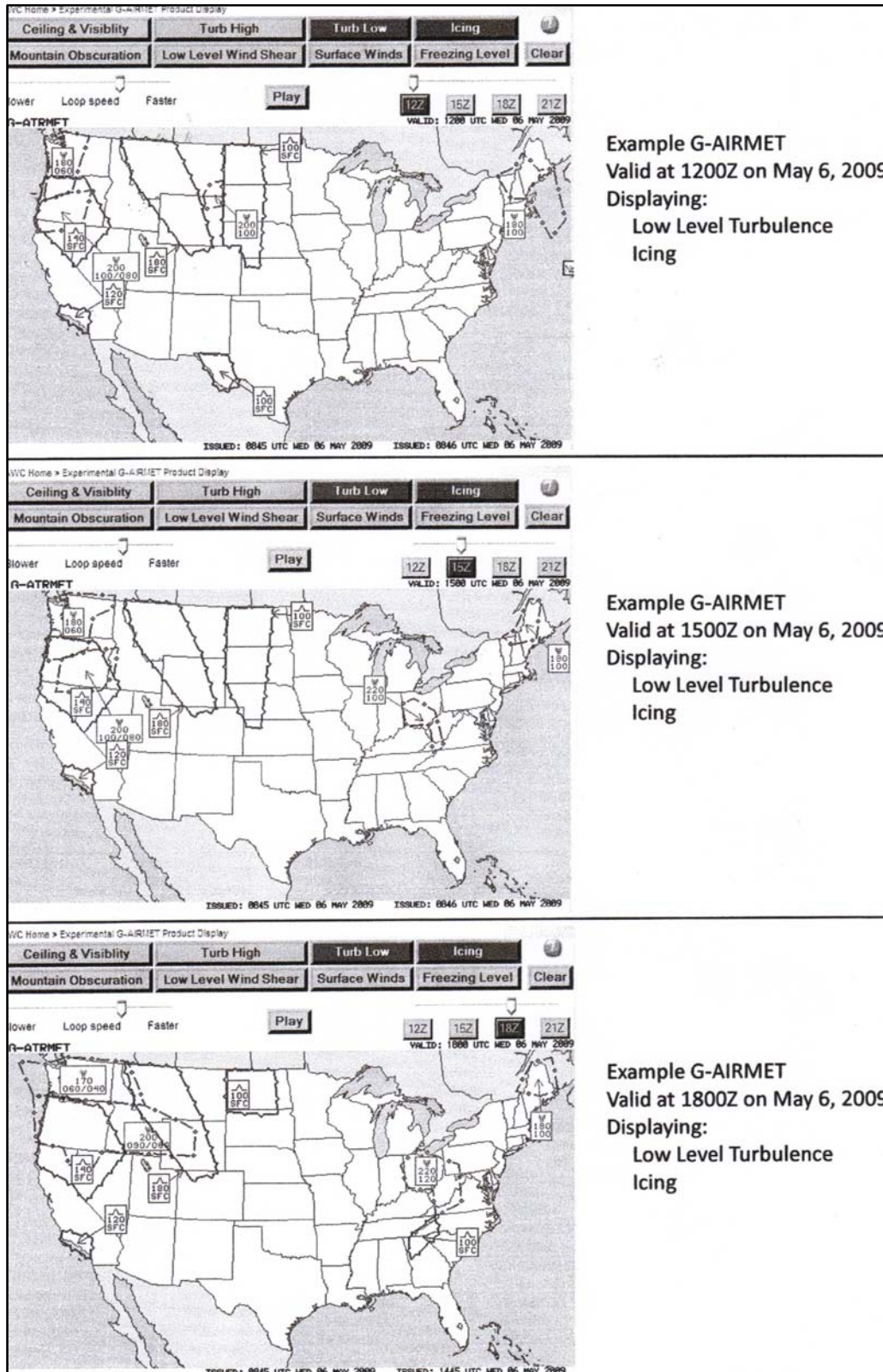

7-1-11. Flight Information Services (FIS)

a. FIS. FIS is a method of disseminating meteorological (MET) and aeronautical information (AI) to displays in the cockpit in order to enhance pilot situational awareness, provide decision support tools, and improve safety. FIS augments traditional pilot voice communication with Flight Service Stations (FSSs), ATC facilities, or Airline Operations Control Centers (AOCCs). FIS is not intended to replace traditional pilot and controller/flight service specialist/aircraft dispatcher preflight briefings or inflight voice communications. FIS, however, can provide textual and graphical information that can help abbreviate and improve the usefulness of such communications. FIS enhances pilot situational awareness and improves safety.

1. Data link Service Providers (DLSP) - DLSP deploy and maintain airborne, ground-based, and, in some cases, space-based infrastructure that supports the transmission of AI/MET information over one or more physical links. DLSP may provide a free of charge or for-fee service that permits end users to uplink and downlink AI/MET and other information. The following are examples of DLSP:

(a) FAA FIS-B. A ground-based broadcast service provided through the ADS-B Universal Access Transceiver (UAT) network. The service provides users with a 978 MHz data link capability when operating within range and line-of-sight of a transmitting ground station. FIS-B enables users of properly equipped aircraft to receive and display a suite of broadcast weather and aeronautical information products.

(b) Non-FAA FIS Systems. Several commercial vendors provide customers with FIS data over both the aeronautical spectrum and on other frequencies using a variety of data link protocols. Services available from these providers vary greatly and may include tier based subscriptions. Advancements in bandwidth technology permits preflight as well as inflight access to the same MET and AI information available on the ground. Pilots and operators using non-FAA FIS for MET and AI information should be knowledgeable regarding the weather services being provided as some commercial vendors may be repackaging NWS sourced weather, while other commercial vendors may alter the weather information to produce vendor-tailored or vendor-specific weather reports and forecasts.

2. Three Data Link Modes. There are three data link modes that may be used for transmitting AI and MET information to aircraft. The intended use of the AI and/or MET information will determine the most appropriate data link service.

(a) Broadcast Mode: A one-way interaction in which AI and/or MET updates or changes applicable to a designated geographic area are continuously transmitted (or transmitted at repeated periodic intervals) to all aircraft capable of receiving the broadcast within the service volume defined by the system network architecture.

(b) Contract/Demand Mode: A two-way interaction in which AI and/or MET information is transmitted to an aircraft in response to a specific request.

(c) Contract/Update Mode: A two-way interaction that is an extension of the Demand Mode. Initial AI and/or MET report(s) are sent to an aircraft and subsequent updates or changes to the AI and/or MET information that meet the contract criteria are automatically or manually sent to an aircraft.

3. To ensure airman compliance with Federal Aviation Regulations, manufacturer's operating manuals should remind airmen to contact ATC controllers, FSS specialists, operator dispatchers, or airline operations control centers for general and mission critical aviation weather information and/or NAS status conditions (such as NOTAMs, Special Use Airspace status, and other government flight information). If FIS products are systemically modified (for example, are displayed as abbreviated plain text and/or graphical depictions), the modification process and limitations of the resultant product should be clearly described in the vendor's user guidance.

4. Operational Use of FIS. Regardless of the type of FIS system being used, several factors must be considered when using FIS:

(a) Before using FIS for inflight operations, pilots and other flight crewmembers should become familiar with the operation of the FIS system to be used, the airborne equipment to be used, including its system architecture, airborne system components, coverage service volume and other limitations of the particular system, modes of operation and indications of various system failures. Users should also be familiar with the specific content and format of the services available from the FIS provider(s). Sources

of information that may provide this specific guidance include manufacturer's manuals, training programs, and reference guides.

(b) FIS should not serve as the sole source of aviation weather and other operational information. ATC, FSSs, and, if applicable, AOCC VHF/HF voice remain as a redundant method of communicating aviation weather, NOTAMs, and other operational information to aircraft in flight. FIS augments these traditional ATC/FSS/AOCC services and, for some products, offers the advantage of being displayed as graphical information. By using FIS for orientation, the usefulness of information received from conventional means may be enhanced. For example, FIS may alert the pilot to specific areas of concern that will more accurately focus requests made to FSS or AOCC for inflight updates or similar queries made to ATC.

(c) The airspace and aeronautical environment is constantly changing. These changes occur quickly and without warning. Critical operational decisions should be based on use of the most current and appropriate data available. When differences exist between FIS and information obtained by voice communication with ATC, FSS, and/or AOCC (if applicable), pilots are cautioned to use the most recent data from the most authoritative source.

(d) FIS aviation weather products (for example, graphical ground-based radar precipitation depictions) are not appropriate for tactical (typical timeframe of less than 3 minutes) avoidance of severe weather such as negotiating a path through a weather hazard area. FIS supports strategic (typical timeframe of 20 minutes or more) weather decisionmaking such as route selection to avoid a weather hazard area in its entirety. The misuse of information beyond its applicability may place the pilot and aircraft in jeopardy. In addition, FIS should never be used in lieu of an individual preflight weather and flight planning briefing.

(e) DLSP offer numerous MET and AI products with information that can be layered on top of each other. Pilots need to be aware that too much information can have a negative effect on their cognitive work load. Pilots need to manage the amount of information to a level that offers the most pertinent information to that specific flight without creating a cockpit distraction. Pilots may need to

adjust the amount of information based on numerous factors including, but not limited to, the phase of flight, single pilot operation, autopilot availability, class of airspace, and the weather conditions encountered.

(f) FIS NOTAM products, including Temporary Flight Restriction (TFR) information, are advisory-use information and are intended for situational awareness purposes only. Cockpit displays of this information are not appropriate for tactical navigation – pilots should stay clear of any geographic area displayed as a TFR NOTAM. Pilots should contact FSSs and/or ATC while en route to obtain updated information and to verify the cockpit display of NOTAM information.

(g) FIS supports better pilot decisionmaking by increasing situational awareness. Better decision-making is based on using information from a variety of sources. In addition to FIS, pilots should take advantage of other weather/NAS status sources, including, briefings from Flight Service Stations, data from other air traffic control facilities, airline operation control centers, pilot reports, as well as their own observations.

(h) FAA's Flight Information Service–Broadcast (FIS–B).

(1) FIS–B is a ground-based broadcast service provided through the FAA's Automatic Dependent Surveillance–Broadcast (ADS–B) Services Universal Access Transceiver (UAT) network. The service provides users with a 978 MHz data link capability when operating within range and line-of-sight of a transmitting ground station. FIS–B enables users of properly-equipped aircraft to receive and display a suite of broadcast weather and aeronautical information products.

(2) The following list represents the initial suite of text and graphical products available through FIS–B and provided free-of-charge. Detailed information concerning FIS–B meteorological products can be found in Advisory Circular 00–45, Aviation Weather Services, and AC 00–63, Use of Cockpit Displays of Digital Weather and Aeronautical Information. Information on Special Use Airspace (SUA), Temporary Flight Restriction (TFR), and Notice to Airmen (NOTAM) products can be found in Chapters 3, 4 and 5 of this manual.

[a] Text: Aviation Routine Weather Report (METAR) and Special Aviation Report (SPECI);

[b] Text: Pilot Weather Report (PIREP);

[c] Text: Winds and Temperatures Aloft;

[d] Text: Terminal Aerodrome Forecast (TAF) and amendments;

[e] Text: Notice to Airmen (NOTAM) Distant and Flight Data Center;

[f] Text/Graphic: Airmen's Meteorological Conditions (AIRMET);

[g] Text/Graphic: Significant Meteorological Conditions (SIGMET);

[h] Text/Graphic: Convective SIGMET;

[i] Text/Graphic: Special Use Airspace (SUA);

[j] Text/Graphic: Temporary Flight Restriction (TFR) NOTAM; and

[k] Graphic: NEXRAD Composite Reflectivity Products (Regional and National).

(3) Users of FIS-B should familiarize themselves with the operational characteristics and limitations of the system, including: system architecture; service environment; product lifecycles; modes of operation; and indications of system failure.

(4) FIS-B products are updated and transmitted at specific intervals based primarily on product issuance criteria. Update intervals are defined as the rate at which the product data is available from the source for transmission. Transmission intervals are defined as the amount of time within which a new or updated product transmission must be completed and/or the rate or repetition interval at which the product is rebroadcast. Update and transmission intervals for each product are provided in TBL 7-1-1.

(5) Where applicable, FIS-B products include a look-ahead range expressed in nautical miles (NM) for three service domains: Airport Surface; Terminal Airspace; and Enroute/Gulf-of-Mexico (GOMEX). TBL 7-1-2 provides service domain availability and look-ahead ranging for each FIS-B product.

(6) Prior to using this capability, users should familiarize themselves with the operation of FIS-B avionics by referencing the applicable User's Guides. Guidance concerning the interpretation of information displayed should be obtained from the appropriate avionics manufacturer.

(7) FIS-B malfunctions not attributed to aircraft system failures or covered by active NOTAM should be reported by radio or telephone to the nearest FSS facility.

b. Non-FAA FIS Systems. Several commercial vendors also provide customers with FIS data over both the aeronautical spectrum and on other frequencies using a variety of data link protocols. In some cases, the vendors provide only the communications system that carries customer messages, such as the Aircraft Communications Addressing and Reporting System (ACARS) used by many air carrier and other operators.

1. Operators using non-FAA FIS data for inflight weather and other operational information should ensure that the products used conform to FAA/NWS standards. Specifically, aviation weather and NAS status information should meet the following criteria:

(a) The products should be either FAA/NWS "accepted" aviation weather reports or products, or based on FAA/NWS accepted aviation weather reports or products. If products are used which do not meet this criteria, they should be so identified. The operator must determine the applicability of such products to their particular flight operations.

(b) In the case of a weather product which is the result of the application of a process which alters the form, function or content of the base FAA/NWS accepted weather product(s), that process, and any limitations to the application of the resultant product, should be described in the vendor's user guidance material.

2. An example would be a NEXRAD radar composite/mosaic map, which has been modified by changing the scaling resolution. The methodology of assigning reflectivity values to the resultant image components should be described in the vendor's guidance material to ensure that the user can accurately interpret the displayed data.

TBL 7-1-1
FIS-B Over UAT Product Update and Transmission Intervals

Product	FIS-B Over UAT Service Update Intervals¹	FIS-B Service Transmission Intervals²
AIRMET	As Available	5 minutes
Convective SIGMET	As Available	5 minutes
METARs/SPECIs	1 minute/As Available	5 minutes
NEXRAD Composite Reflectivity (CONUS)	15 minutes	15 minutes
NEXRAD Composite Reflectivity (Regional)	5 minutes	2.5 minutes
NOTAMs-D/FDC/TFR	As Available	10 minutes
PIREP	As Available	10 minutes
SIGMET	As Available	5 minutes
SUA Status	As Available	10 minutes
TAF/AMEND	8 Hours/As Available	10 minutes
Temperatures Aloft	12 Hours	10 minutes
Winds Aloft	12 Hours	10 minutes

¹ *The Update Interval is the rate at which the product data is available from the source.*

² *The Transmission Interval is the amount of time within which a new or updated product transmission must be completed and the rate or repetition interval at which the product is rebroadcast.*

TBL 7-1-2
Product Parameters for Low/Medium/High Altitude Tier Radios

Product	Surface Radios	Low Altitude Tier	Medium Altitude Tier	High Altitude Tier
CONUS NEXRAD	N/A	CONUS NEXRAD not provided	CONUS NEXRAD imagery	CONUS NEXRAD imagery
Winds & Temps Aloft	500 NM look-ahead range	500 NM look-ahead range	750 NM look-ahead range	1,000 NM look-ahead range
METAR	100 NM look-ahead range	250 NM look-ahead range	375 NM look-ahead range	CONUS: CONUS Class B & C airport METARs and 500 NM look-ahead range Outside of CONUS: 500 NM look-ahead range
TAF	100 NM look-ahead range	250 NM look-ahead range	375 NM look-ahead range	CONUS: CONUS Class B & C airport TAFs and 500 NM look-ahead range Outside of CONUS: 500 NM look-ahead range
AIRMET, SIGMET, PIREP, and SUA/SAA	100 NM look-ahead range. PIREP/SUA/SAA is N/A.	250 NM look-ahead range	375 NM look-ahead range	500 NM look-ahead range
Regional NEXRAD	150 NM look-ahead range	150 NM look-ahead range	200 NM look-ahead range	250 NM look-ahead range
NOTAMs D, FDC, and TFR	100 NM look-ahead range	100 NM look-ahead range	100 NM look-ahead range	100 NM look-ahead range

7-1-12. Weather Observing Programs

a. Manual Observations. With only a few exceptions, these reports are from airport locations staffed by FAA personnel who manually observe, perform calculations, and enter these observations into the (WMSCR) communication system. The format and coding of these observations are contained in Paragraph 7-1-30, Key to Aviation Routine Weather Report (METAR) and Aerodrome Forecasts (TAF).

b. Automated Weather Observing System (AWOS).

1. Automated weather reporting systems are increasingly being installed at airports. These systems consist of various sensors, a processor, a computer-generated voice subsystem, and a transmit-

ter to broadcast local, minute-by-minute weather data directly to the pilot.

NOTE-

When the barometric pressure exceeds 31.00 inches Hg., see Paragraph 7-2-2, Procedures, for the altimeter setting procedures.

2. The AWOS observations will include the prefix “AUTO” to indicate that the data are derived from an automated system. Some AWOS locations will be augmented by certified observers who will provide weather and obstruction to vision information in the remarks of the report when the reported visibility is less than 7 miles. These sites, along with the hours of augmentation, are to be published in the Chart Supplement U.S. Augmentation is identified in the observation as “OBSERVER WEATHER.” The AWOS wind speed, direction and gusts, temperature,

dew point, and altimeter setting are exactly the same as for manual observations. The AWOS will also report density altitude when it exceeds the field elevation by more than 1,000 feet. The reported visibility is derived from a sensor near the touchdown of the primary instrument runway. The visibility sensor output is converted to a visibility value using a 10-minute harmonic average. The reported sky condition/ceiling is derived from the ceilometer located next to the visibility sensor. The AWOS algorithm integrates the last 30 minutes of ceilometer data to derive cloud layers and heights. This output may also differ from the observer sky condition in that the AWOS is totally dependent upon the cloud advection over the sensor site.

3. These real-time systems are operationally classified into nine basic levels:

(a) **AWOS-A** only reports altimeter setting;

NOTE-

Any other information is advisory only.

(b) **AWOS-AV** reports altimeter and visibility;

NOTE-

Any other information is advisory only.

(c) **AWOS-I** usually reports altimeter setting, wind data, temperature, dew point, and density altitude;

(d) **AWOS-2** provides the information provided by AWOS-1 plus visibility; and

(e) **AWOS-3** provides the information provided by AWOS-2 plus cloud/ceiling data.

(f) **AWOS-3P** provides reports the same as the AWOS 3 system, plus a precipitation identification sensor.

(g) **AWOS-3PT** reports the same as the AWOS 3P System, plus thunderstorm/lightning reporting capability.

(h) **AWOS-3T** reports the same as AWOS 3 system and includes a thunderstorm/lightning reporting capability.

(i) **AWOS-4** reports the same as the AWOS 3 system, plus precipitation occurrence, type and accumulation, freezing rain, thunderstorm, and runway surface sensors.

4. The information is transmitted over a discrete VHF radio frequency or the voice portion of a local

NAVAID. AWOS transmissions on a discrete VHF radio frequency are engineered to be receivable to a maximum of 25 NM from the AWOS site and a maximum altitude of 10,000 feet AGL. At many locations, AWOS signals may be received on the surface of the airport, but local conditions may limit the maximum AWOS reception distance and/or altitude. The system transmits a 20 to 30 second weather message updated each minute. Pilots should monitor the designated frequency for the automated weather broadcast. A description of the broadcast is contained in subparagraph c. There is no two-way communication capability. Most AWOS sites also have a dial-up capability so that the minute-by-minute weather messages can be accessed via telephone.

5. AWOS information (system level, frequency, phone number, etc.) concerning specific locations is published, as the systems become operational, in the Chart Supplement U.S., and where applicable, on published Instrument Approach Procedures. Selected individual systems may be incorporated into nationwide data collection and dissemination networks in the future.

c. AWOS Broadcasts. Computer-generated voice is used in AWOS to automate the broadcast of the minute-by-minute weather observations. In addition, some systems are configured to permit the addition of an operator-generated voice message; e.g., weather remarks following the automated parameters. The phraseology used generally follows that used for other weather broadcasts. Following are explanations and examples of the exceptions.

1. Location and Time. The location/name and the phrase "AUTOMATED WEATHER OBSERVATION," followed by the time are announced.

(a) If the airport's specific location is included in the airport's name, the airport's name is announced.

EXAMPLE-

"Bremerton National Airport automated weather observation, one four five six zulu;"

"Ravenswood Jackson County Airport automated weather observation, one four five six zulu."

(b) If the airport's specific location is not included in the airport's name, the location is announced followed by the airport's name.

EXAMPLE-

“Sault Ste. Marie, Chippewa County International Airport automated weather observation;”
“Sandusky, Cowley Field automated weather observation.”

(c) The word “TEST” is added following “OBSERVATION” when the system is not in commissioned status.

EXAMPLE-

“Bremerton National Airport automated weather observation test, one four five six zulu.”

(d) The phrase “TEMPORARILY INOPERATIVE” is added when the system is inoperative.

EXAMPLE-

“Bremerton National Airport automated weather observing system temporarily inoperative.”

2. Visibility.

(a) The lowest reportable visibility value in AWOS is “less than $\frac{1}{4}$.” It is announced as “VISIBILITY LESS THAN ONE QUARTER.”

(b) A sensor for determining visibility is not included in some AWOS. In these systems, visibility is not announced. “VISIBILITY MISSING” is announced only if the system is configured with a visibility sensor and visibility information is not available.

3. Weather. In the future, some AWOSs are to be configured to determine the occurrence of precipitation. However, the type and intensity may not always be determined. In these systems, the word “PRECIPITATION” will be announced if precipitation is occurring, but the type and intensity are not determined.

4. Ceiling and Sky Cover.

(a) Ceiling is announced as either “CEILING” or “INDEFINITE CEILING.” With the exception of indefinite ceilings, all automated ceiling heights are measured.

EXAMPLE-

“Bremerton National Airport automated weather observation, one four five six zulu. Ceiling two thousand overcast;”

“Bremerton National Airport automated weather observation, one four five six zulu. Indefinite ceiling two hundred, sky obscured.”

(b) The word “Clear” is not used in AWOS due to limitations in the height ranges of the sensors.

No clouds detected is announced as “NO CLOUDS BELOW XXX” or, in newer systems as “CLEAR BELOW XXX” (where XXX is the range limit of the sensor).

EXAMPLE-

“No clouds below one two thousand.”
“Clear below one two thousand.”

(c) A sensor for determining ceiling and sky cover is not included in some AWOS. In these systems, ceiling and sky cover are not announced. “SKY CONDITION MISSING” is announced only if the system is configured with a ceilometer and the ceiling and sky cover information is not available.

5. Remarks. If remarks are included in the observation, the word “REMARKS” is announced following the altimeter setting.

(a) Automated “Remarks.”

- (1) Density Altitude.
- (2) Variable Visibility.
- (3) Variable Wind Direction.

(b) Manual Input Remarks. Manual input remarks are prefaced with the phrase “OBSERVER WEATHER.” As a general rule the manual remarks are limited to:

- (1) Type and intensity of precipitation.
- (2) Thunderstorms and direction; and
- (3) Obstructions to vision when the visibility is 3 miles or less.

EXAMPLE-

“Remarks ... density altitude, two thousand five hundred ... visibility variable between one and two ... wind direction variable between two four zero and three one zero ... observed weather ... thunderstorm moderate rain showers and fog ... thunderstorm overhead.”

(c) If an automated parameter is “missing” and no manual input for that parameter is available, the parameter is announced as “MISSING.” For example, a report with the dew point “missing” and no manual input available, would be announced as follows:

EXAMPLE-

“Ceiling one thousand overcast ... visibility three ... precipitation ... temperature three zero, dew point missing ... wind calm ... altimeter three zero zero one.”

(d) “REMARKS” are announced in the following order of priority:

- (1) Automated “REMARKS.”
 - [a] Density Altitude.
 - [b] Variable Visibility.
 - [c] Variable Wind Direction.
- (2) Manual Input “REMARKS.”
 - [a] Sky Condition.
 - [b] Visibility.
 - [c] Weather and Obstructions to Vision.
 - [d] Temperature.
 - [e] Dew Point.
 - [f] Wind; and
 - [g] Altimeter Setting.

EXAMPLE—

“Remarks ... density altitude, two thousand five hundred ... visibility variable between one and two ... wind direction variable between two four zero and three one zero ... observer ceiling estimated two thousand broken ... observer temperature two, dew point minus five.”

d. Automated Surface Observing System (ASOS)/Automated Weather Observing System (AWOS) The ASOS/AWOS is the primary surface weather observing system of the U.S. (See Key to Decode an ASOS/AWOS (METAR) Observation, FIG 7-1-7 and FIG 7-1-8.) The program to install and operate these systems throughout the U.S. is a joint effort of the NWS, the FAA and the Department of Defense. ASOS/AWOS is designed to support aviation operations and weather forecast activities. The ASOS/AWOS will provide continuous minute-by-minute observations and perform the basic observing functions necessary to generate an aviation routine weather report (METAR) and other aviation weather information. The information may be transmitted over a discrete VHF radio frequency or the voice portion of a local NAVAID. ASOS/AWOS transmissions on a discrete VHF radio frequency are engineered to be receivable to a maximum of 25 NM from the ASOS/AWOS site and a maximum altitude of 10,000 feet AGL. At many locations, ASOS/AWOS signals may be received on the surface of the airport, but local conditions may limit the maximum reception distance and/or altitude. While the automated system and the human may differ in their methods of data collection and interpretation, both produce an observation quite similar in form and

content. For the “objective” elements such as pressure, ambient temperature, dew point temperature, wind, and precipitation accumulation, both the automated system and the observer use a fixed location and time-averaging technique. The quantitative differences between the observer and the automated observation of these elements are negligible. For the “subjective” elements, however, observers use a fixed time, spatial averaging technique to describe the visual elements (sky condition, visibility and present weather), while the automated systems use a fixed location, time averaging technique. Although this is a fundamental change, the manual and automated techniques yield remarkably similar results within the limits of their respective capabilities.

1. System Description.

(a) The ASOS/AWOS at each airport location consists of four main components:

- (1) Individual weather sensors.
- (2) Data collection and processing units.
- (3) Peripherals and displays.

(b) The ASOS/AWOS sensors perform the basic function of data acquisition. They continuously sample and measure the ambient environment, derive raw sensor data and make them available to the collection and processing units.

2. Every ASOS/AWOS will contain the following basic set of sensors:

- (a) Cloud height indicator (one or possibly three).
- (b) Visibility sensor (one or possibly three).
- (c) Precipitation identification sensor.
- (d) Freezing rain sensor (at select sites).
- (e) Pressure sensors (two sensors at small airports; three sensors at large airports).
- (f) Ambient temperature/Dew point temperature sensor.
- (g) Anemometer (wind direction and speed sensor).
- (h) Rainfall accumulation sensor.
- (i) Automated Lightning Detection and Reporting System (ALDARS) (excluding Alaska and Pacific Island sites).

3. The ASOS/AWOS data outlets include:

- (a) Those necessary for on-site airport users.
- (b) National communications networks.
- (c) Computer-generated voice (available through FAA radio broadcast to pilots, and dial-in telephone line).

NOTE—

Wind direction broadcast over FAA radios is in reference to magnetic north.

4. An ASOS/AWOS report without human intervention will contain only that weather data capable of being reported automatically. The modifier for this METAR report is “AUTO.” When

an observer augments or backs-up an ASOS/AWOS site, the “AUTO” modifier disappears.

5. There are two types of automated stations, AO1 for automated weather reporting stations without a precipitation discriminator, and AO2 for automated stations with a precipitation discriminator. As appropriate, “AO1” and “AO2” must appear in remarks. (A precipitation discriminator can determine the difference between liquid and frozen/freezing precipitation).

NOTE—

To decode an ASOS/AWOS report, refer to FIG 7-1-7 and FIG 7-1-8.

REFERENCE—

A complete explanation of METAR terminology is located in AIM, Paragraph 7-1-30, Key to Aerodrome Forecast (TAF) and Aviation Routine Weather Report (METAR).

FIG 7-1-7

Key to Decode an ASOS/AWOS (METAR) Observation (Front)

METAR KABC 121755Z AUTO 21016G24KT 180V240 1SM R11/P6000FT -RA BR BKN015 OVC025 06/04 A2990
 RMK A02 PK WND 20032/25 WSHFT 1715 VIS 3/4V1 1/2 VIS 3/4 RWDY11 RAB07 CIG 013V017 CIG 017 RWDY11 PRESFR
 SLP125 P0003 6009 T00640036 10066 21012 58033 TSNO \$

TYPE OF REPORT	METAR: hourly (scheduled report; SPECI: special (unscheduled) report.	METAR
STATION IDENTIFIER	Four alphabetic characters; ICAO location identifiers.	KABC
DATE/TIME	All dates and times in UTC using a 24-hour clock; two-digit date and four-digit time; always appended with <u>Z</u> to indicate UTC.	121755Z
REPORT MODIFIER	Fully automated report, no human intervention; removed when observer signed-on.	AUTO
WIND DIRECTION AND SPEED	Direction in tens of degrees from true north (first three digits); next two digits: speed in whole knots; as needed <u>G</u> usts (character) followed by maximum observed speed; always appended with <u>KT</u> to indicate knots; 0000KT for calm; if direction varies by 60° or more a <u>V</u> ariable wind direction group is reported.	21016G24KT 108V240
VISIBILITY	Prevailing visibility in statute miles and fractions (space between whole miles and fractions); always appended with <u>SM</u> to indicate statute miles.	1SM
RUNWAY VISUAL RANGE	10-minute RVR value in hundreds of feet; reported if prevailing visibility is ≤ one mile or RVR ≤6000 feet; always appended with <u>FT</u> to indicate feet; value prefixed with <u>M</u> or <u>P</u> to indicate value is lower or higher than the reportable RVR value.	R11/P6000FT
WEATHER PHENOMENA	RA: liquid precipitation that does not freeze; SN: frozen precipitation other than hail; UP: precipitation of unknown type; intensity prefixed to precipitation: light (-), moderate (no sign), heavy (+); FG: fog; FZFG: freezing fog (temperature below 0°C); BR: mist; HZ: haze; SQ: squall; maximum of three groups reported; augmented by observer: FC (funnel cloud/tornado/waterspout); TS(thunderstorm); GR (hail); GS (small hail; <1/4 inch); FZRA (intensity; freezing rain); VA (volcanic ash).	-RA BR
SKY CONDITION	Cloud amount and height: CLR (no clouds detected below 12000 feet); FEW (few); SCT (scattered); BKN (broken); OVC (overcast); followed by 3-digit height in hundreds of feet; or vertical visibility (<u>VV</u>) followed by height for indefinite ceiling.	BKN015 OVC025
TEMPERATURE/DEW POINT	Each is reported in whole degrees Celsius using two digits; values are separated by a solidus; sub-zero values are prefixed with an <u>M</u> (minus).	06/04
ALTIMETER	Altimeter always prefixed with an <u>A</u> indicating inches of mercury; reported using four digits: tens, units, tenths, and hundredths.	A2990

FIG 7-1-8

Key to Decode an ASOS/AWOS (METAR) Observation (Back)

REMARKS IDENTIFIER: RMK	RMK
TORNADIC ACTIVITY: Augmented; report should include TORNADO, FUNNEL CLOUD, or WATERSPOUT, time begin/end, location, movement; e.g., TORNADO B25 N MOV E.	
TYPE OF AUTOMATED STATION: AO2; automated station with precipitation discriminator.	AO2
PEAK WIND: PK WND dddfff(f)/(hh)mm; direction in tens of degrees, speed in whole knots, and time.	PK WND 20032/25
WIND SHIFT: WSHFT (hh)mm	WSHFT 1715
TOWER OR SURFACE VISIBILITY: TWR VIS vvvvv: visibility reported by tower personnel, e.g., TWR VIS 2; SFC VIS vvvvv: visibility reported by ASOS, e.g., SFC VIS 2.	
VARIABLE PREVAILING VISIBILITY: VIS v _n v _n v _n v _n v _n v _n V _v V _x V _x V _x V _x ; reported if prevailing visibility is <3 miles and variable.	VIS 3/4V1 1/2
VISIBILITY AT SECOND LOCATION: VIS vvvvv [LOC]; reported if different than the reported prevailing visibility in body of report.	VIS 3/4 RWY11
LIGHTNING: [FREQ] LTG [LOC]; when detected the frequency and location is reported, e.g., FRQ LTG NE.	
BEGINNING AND ENDING OF PRECIPITATION AND THUNDERSTORMS: w'w'B(hh)mmE(hh)mm; TSB(hh)mmE(hh)mm	RAB07
VIRGA: Augmented; precipitation not reaching the ground, e.g., VIRGA.	
VARIABLE CEILING HEIGHT: CIG h _n h _n Vh _x h _x h _x ; reported if ceiling in body of report is <3000 feet and variable.	CIG 013V017
CEILING HEIGHT AT SECOND LOCATION: CIG hhh [LOC]; Ceiling height reported if secondary ceilmeter site is different than the ceiling height in the body of the report.	CIG 017 RWY11
PRESSURE RISING OR FALLING RAPIDLY: PRESRR or PRESFR; pressure rising or falling rapidly at time of observation.	PRESFR
SEA-LEVEL PRESSURE: SLPppp; tens, units, and tenths of SLP in hPa.	SLPI25
HOURLY PRECIPITATION AMOUNT: Prrrr; in .01 inches since last METAR; a trace is P0000.	P0003
3- AND 6-HOUR PRECIPITATION AMOUNT: 6RRRR; precipitation amount in .01 inches for past 6 hours reported in 00, 06, 12, and 18 UTC observations and for past 3 hours in 03, 09, 15, and 21 UTC observations; a trace is 60000.	60009
24-HOUR PRECIPITATION AMOUNT: 7R ₂₄ R ₂₄ R ₂₄ ; precipitation amount in .01 inches for past 24 hours reported in 12 UTC observation, e.g., 70015.	
HOURLY TEMPERATURE AND DEW POINT: T _s T _a T _a T _s T _a T _a T _s T _a ; tenth of degree Celsius; s _n : 1 if temperature below 0° C and 0 if temperature 0° C or higher.	T00640036
6-HOUR MAXIMUM TEMPERATURE: 1s _n T _x T _x T _x ; tenth of degree Celsius; 00, 06, 12, 18 UTC; s _n : 1 if temperature below 0° C and 0 if temperature 0° C or higher.	10066
6-HOUR MINIMUM TEMPERATURE: 2s _n T _n T _n T _n ; tenth of degree Celsius; 00, 06, 12, 18 UTC; s _n : 1 if temperature below 0° C and 0 if temperature 0° C or higher.	21012
24-HOUR MAXIMUM AND MINIMUM TEMPERATURE: 4s _n T _x T _x T _s T _n T _n T _s T _n T _n ; tenth of degree Celsius; reported at midnight local standard time; 1 if temperature below 0° C and 0 if temperature 0° C or higher, e.g., 400461006.	
PRESSURE TENDENCY: 5app; the character (a) and change in pressure (ppp; tenths of hPa) the past 3 hours.	58033
SENSOR STATUS INDICATORS: RVRNO: RVR missing; PWINO: precipitation identifier information not available; PNO: precipitation amount not available; FZRANO: freezing rain information not available; TSNO: thunderstorm information not available; VISNO [LOC]: visibility at secondary location not available, e.g., VISNO RWY06; CHINO [LOC]: (cloud-height-indicator) sky condition at secondary location not available, e.g., CHINO RWY06.	TSNO
MAINTENANCE CHECK INDICATOR: Maintenance needed on the system.	
If an element or phenomena does not occur, is missing, or cannot be observed, the corresponding group and space are omitted (body and/or remarks) from that particular report, except for Sea-Level Pressure (SLPppp). SLPNO shall be reported in a METAR when the SLP is not available.	\$
U.S. DEPARTMENT OF TRANSPORTATION • FEDERAL AVIATION ADMINISTRATION • Aviation Weather Directorate, 400 7 th Street, SW, Rooms 6200-8326, Washington, D.C. 20591	

e. TBL 7-1-3 contains a comparison of weather observing programs and the elements reported.

f. **Service Standards.** During 1995, a government/industry team worked to comprehensively reassess the requirements for surface observations at the nation’s airports. That work resulted in agreement on a set of service standards, and the FAA and NWS ASOS sites to which the standards would apply. The term “Service Standards” refers to the level of detail in weather observation. The service standards consist of four different levels of service (A, B, C, and D) as described below. Specific observational elements included in each service level are listed in TBL 7-1-4.

1. **Service Level D** defines the minimum acceptable level of service. It is a completely automated service in which the ASOS/AWOS observation will constitute the entire observation, i.e., no additional weather information is added by a human observer. This service is referred to as a stand alone D site.

2. **Service Level C** is a service in which the human observer, usually an air traffic controller, augments or adds information to the automated observation. Service Level C also includes backup of ASOS/AWOS elements in the event of an ASOS/AWOS malfunction or an unrepresentative ASOS/AWOS report. In backup, the human observer

inserts the correct or missing value for the automated ASOS/AWOS elements. This service is provided by air traffic controllers under the Limited Aviation Weather Reporting Station (LAWRS) process, FSS and NWS observers, and, at selected sites, Non-Federal Observation Program observers.

Two categories of airports require detail beyond Service Level C in order to enhance air traffic control efficiency and increase system capacity. Services at these airports are typically provided by contract weather observers, NWS observers, and, at some locations, FSS observers.

3. **Service Level B** is a service in which weather observations consist of all elements provided under Service Level C, plus augmentation of additional data beyond the capability of the ASOS/AWOS. This category of airports includes smaller hubs or special airports in other ways that have worse than average bad weather operations for thunderstorms and/or freezing/frozen precipitation, and/or that are remote airports.

4. **Service Level A**, the highest and most demanding category, includes all the data reported in Service Standard B, plus additional requirements as specified. Service Level A covers major aviation hubs and/or high volume traffic airports with average or worse weather.

TBL 7-1-3
Weather Observing Programs

Element Reported Type	Wind	Visibility	Temperature Dew Point	Altimeter	Density Altimeter	Cloud/Ceiling	Precipitation Identification	Thunderstorm/ Lightning	Precipitation Occurrence	Rainfall Accumulation	Runway Surface Condition	Freezing Rain Occurrence	Remarks
ASOS	X	X	X	X	X	X	X			X		X	X
AWOS-A				X									
AWOS-A/V		X		X									
AWOS-1	X		X	X	X								
AWOS-2	X	X	X	X	X								
AWOS-3	X	X	X	X	X	X							
AWOS-3P	X	X	X	X	X	X	X						
AWOS-3T	X	X	X	X	X	X		X					
AWOS-3P/T	X	X	X	X	X	X	X	X					
AWOS-4	X	X	X	X	X	X	X	X	X	X	X	X	
Manual	X	X	X	X		X	X						X

REFERENCE- FAA Order JO 7900.5, Surface Weather Observing, for element reporting.

TBL 7-1-4

SERVICE LEVEL A	
Service Level A consists of all the elements of Service Levels B, C and D plus the elements listed to the right, if observed.	10 minute longline RVR at precedented sites or additional visibility increments of 1/8, 1/16 and 0 Sector visibility Variable sky condition Cloud layers above 12,000 feet and cloud types Widespread dust, sand and other obscurations Volcanic eruptions
SERVICE LEVEL B	
Service Level B consists of all the elements of Service Levels C and D plus the elements listed to the right, if observed.	Longline RVR at precedented sites (may be instantaneous readout) Freezing drizzle versus freezing rain Ice pellets Snow depth & snow increasing rapidly remarks Thunderstorm and lightning location remarks Observed significant weather not at the station remarks
SERVICE LEVEL C	
Service Level C consists of all the elements of Service Level D plus augmentation and backup by a human observer or an air traffic control specialist on location nearby. Backup consists of inserting the correct value if the system malfunctions or is unrepresentative. Augmentation consists of adding the elements listed to the right, if observed. During hours that the observing facility is closed, the site reverts to Service Level D.	Thunderstorms Tornadoes Hail Virga Volcanic ash Tower visibility Operationally significant remarks as deemed appropriate by the observer
SERVICE LEVEL D	
This level of service consists of an ASOS or AWOS continually measuring the atmosphere at a point near the runway. The ASOS or AWOS senses and measures the weather parameters listed to the right.	Wind Visibility Precipitation/Obstruction to vision Cloud height Sky cover Temperature Dew point Altimeter

7-1-13. Weather Radar Services

a. The National Weather Service operates a network of radar sites for detecting coverage, intensity, and movement of precipitation. The network is supplemented by FAA and DOD radar sites in the western sections of the country. Local warning radar sites augment the network by operating on an as needed basis to support warning and forecast programs.

b. Scheduled radar observations are taken hourly and transmitted in alpha-numeric format on weather telecommunications circuits for flight planning purposes. Under certain conditions, special radar reports are issued in addition to the hourly

transmittals. Data contained in the reports are also collected by the National Center for Environmental Prediction and used to prepare national radar summary charts for dissemination on facsimile circuits.

c. A clear radar display (no echoes) does not mean that there is no significant weather within the coverage of the radar site. Clouds and fog are not detected by the radar. However, when echoes are present, turbulence can be implied by the intensity of the precipitation, and icing is implied by the presence of the precipitation at temperatures at or below zero degrees Celsius. Used in conjunction with other weather products, radar provides invaluable information for weather avoidance and flight planning.

FIG 7-1-9
NEXRAD Coverage

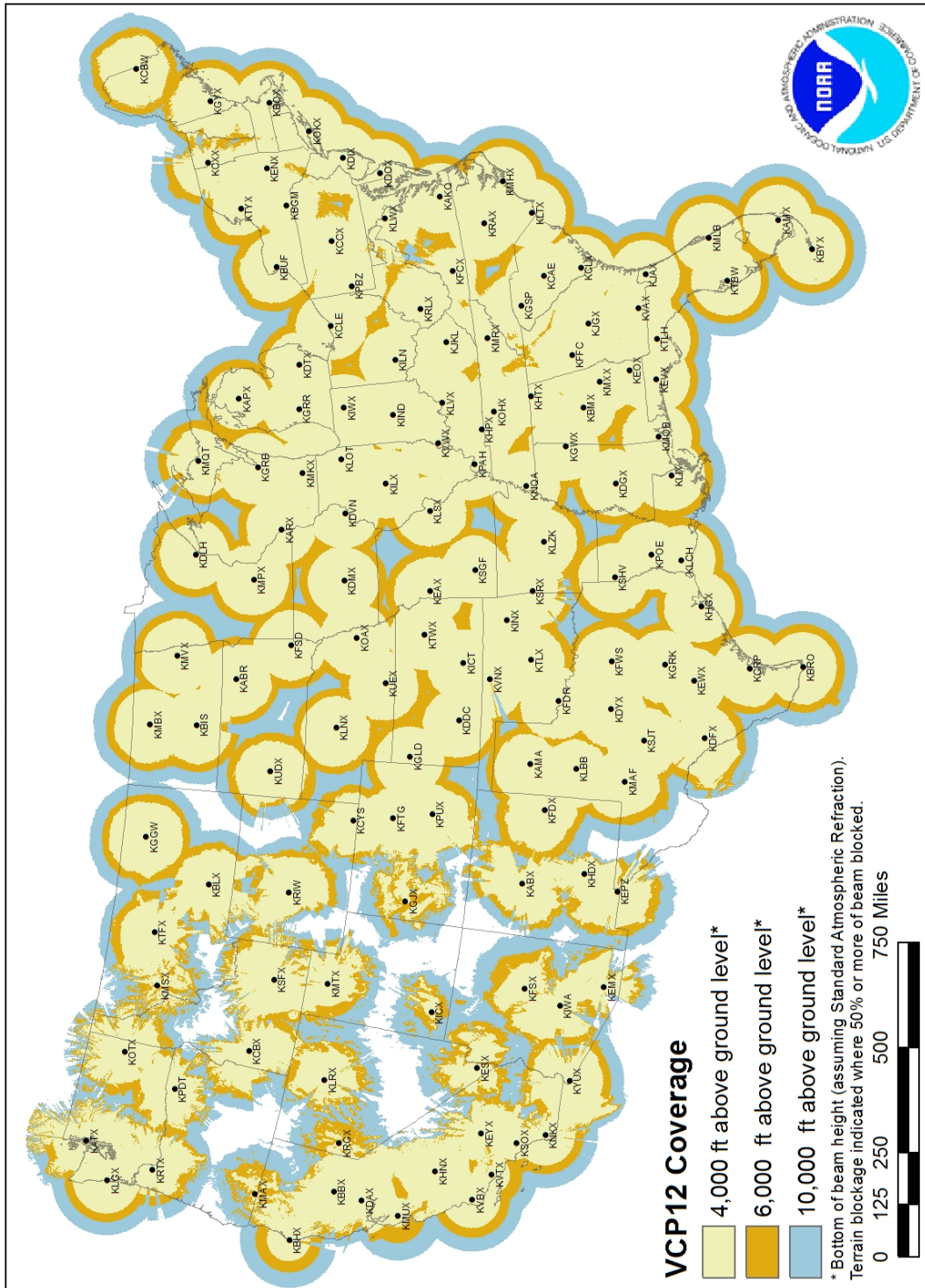

FIG 7-1-10
NEXRAD Coverage

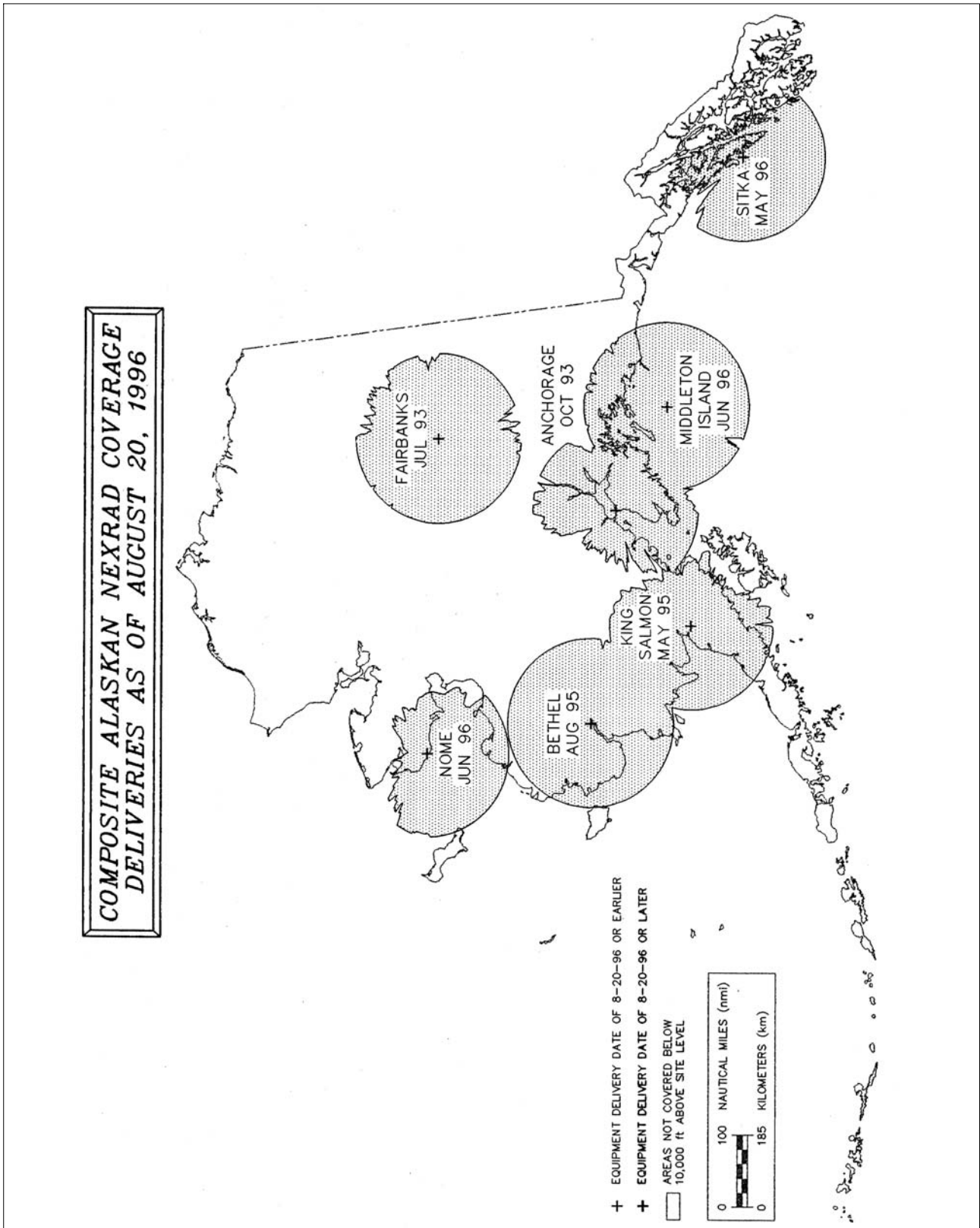
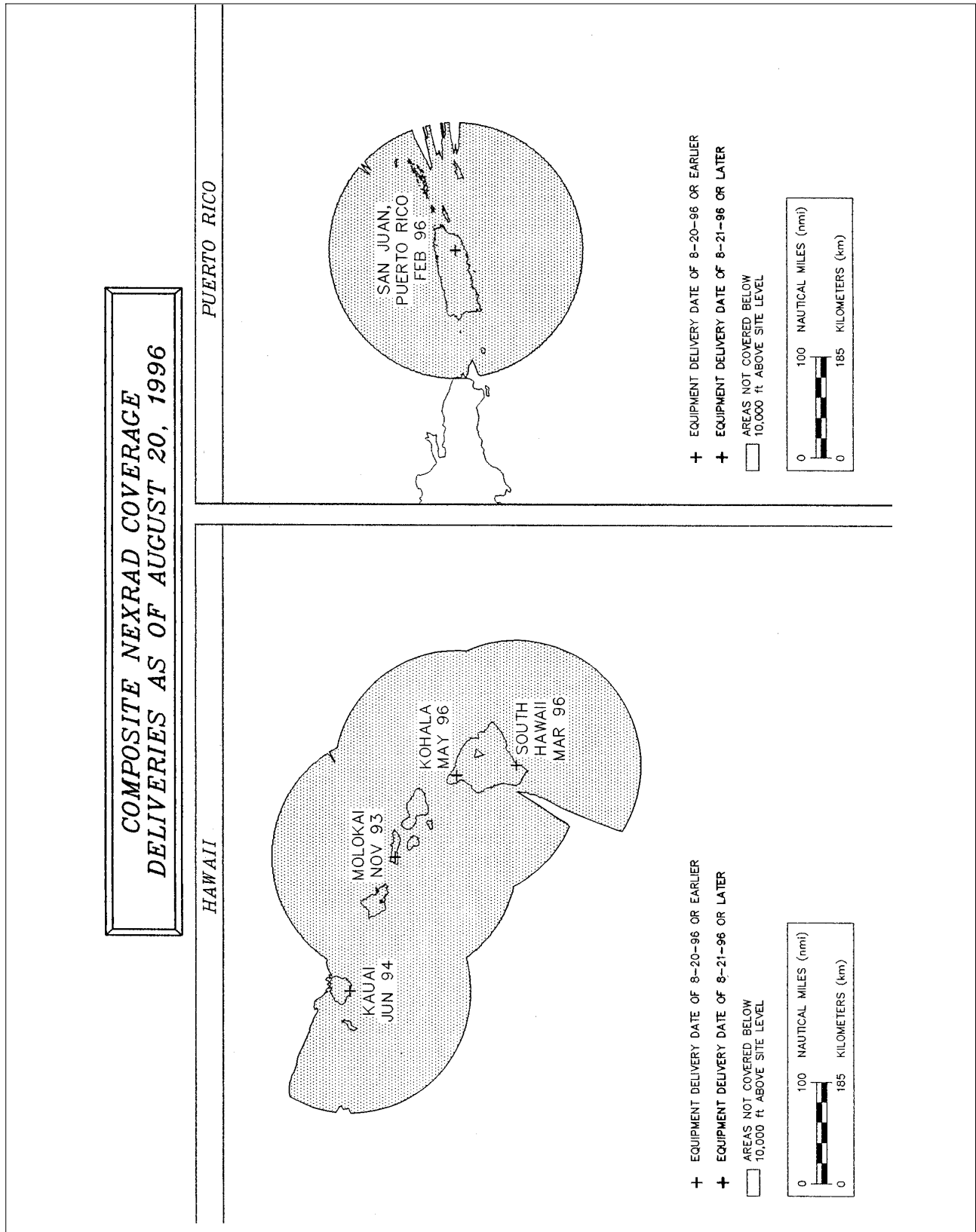

FIG 7-1-11
NEXRAD Coverage



d. All En Route Flight Advisory Service facilities and FSSs have equipment to directly access the radar displays from the individual weather radar sites. Specialists at these locations are trained to interpret the display for pilot briefing and inflight advisory services. The Center Weather Service Units located in ARTCCs also have access to weather radar displays and provide support to all air traffic facilities within their center's area.

e. Additional information on weather radar products and services can be found in AC 00-45, Aviation Weather Services.

REFERENCE-

Pilot/Controller Glossary Term- Precipitation Radar Weather Descriptions.

AIM, Paragraph 7-1-28, Thunderstorms

Chart Supplement U.S., Charts, NWS Upper Air Observing Stations and Weather Network for the location of specific radar sites.

7-1-14. ATC Inflight Weather Avoidance Assistance

a. ATC Radar Weather Display.

1. ATC radars are able to display areas of precipitation by sending out a beam of radio energy that is reflected back to the radar antenna when it strikes an object or moisture which may be in the form of rain drops, hail, or snow. The larger the object is, or the more dense its reflective surface, the stronger the return will be presented. Radar weather processors indicate the intensity of reflective returns in terms of decibels (dBZ). ATC systems cannot detect the presence or absence of clouds. The ATC systems can often determine the intensity of a precipitation area, but the specific character of that area (snow, rain, hail, VIRGA, etc.) cannot be determined. For this reason, ATC refers to all weather areas displayed on ATC radar scopes as "precipitation."

2. All ATC facilities using radar weather processors with the ability to determine precipitation intensity, will describe the intensity to pilots as:

- (a) "LIGHT" (< 26 dBZ)
- (b) "MODERATE" (26 to 40 dBZ)
- (c) "HEAVY" (> 40 to 50 dBZ)
- (d) "EXTREME" (> 50 dBZ)

NOTE-

En route ATC radar's Weather and Radar Processor (WARP) does not display light precipitation intensity.

3. ATC facilities that, due to equipment limitations, cannot display the intensity levels of precipitation, will describe the location of the precipitation area by geographic position, or position relative to the aircraft. Since the intensity level is not available, the controller will state "INTENSITY UNKNOWN."

4. ARTCC facilities normally use a Weather and Radar Processor (WARP) to display a mosaic of data obtained from multiple NEXRAD sites. There is a time delay between actual conditions and those displayed to the controller. For example, the precipitation data on the ARTCC controller's display could be up to 6 minutes old. When the WARP is not available, a second system, the narrowband Air Route Surveillance Radar (ARSR) can display two distinct levels of precipitation intensity that will be described to pilots as "MODERATE" (30 to 40 dBZ) and "HEAVY TO EXTREME" (> 40 dBZ). The WARP processor is only used in ARTCC facilities.

5. *ATC radar is not able to detect turbulence.* Generally, turbulence can be expected to occur as the rate of rainfall or intensity of precipitation increases. Turbulence associated with greater rates of rainfall/precipitation will normally be more severe than any associated with lesser rates of rainfall/precipitation. Turbulence should be expected to occur near convective activity, even in clear air. Thunderstorms are a form of convective activity that imply severe or greater turbulence. Operation within 20 miles of thunderstorms should be approached with great caution, as the severity of turbulence can be markedly greater than the precipitation intensity might indicate.

b. Weather Avoidance Assistance.

1. To the extent possible, controllers will issue pertinent information on weather or chaff areas and assist pilots in avoiding such areas when requested. Pilots should respond to a weather advisory by either acknowledging the advisory or by acknowledging the advisory and requesting an alternative course of action as follows:

(a) Request to deviate off course by stating a heading or degrees, direction of deviation, and approximate number of miles. In this case, when the requested deviation is approved, navigation is at the pilot's prerogative, but must maintain the altitude assigned, and remain within the lateral restrictions issued by ATC.

(b) An approval for lateral deviation authorizes the pilot to maneuver left or right within the limits specified in the clearance.

NOTE—

1. It is often necessary for ATC to restrict the amount of lateral deviation (“twenty degrees right,” “up to fifteen degrees left,” “up to ten degrees left or right of course”).

2. The term “when able, proceed direct,” in an ATC weather deviation clearance, refers to the pilot’s ability to remain clear of the weather when returning to course/route.

(c) Request a new route to avoid the affected area.

(d) Request a change of altitude.

(e) Request radar vectors around the affected areas.

2. For obvious reasons of safety, an IFR pilot must not deviate from the course or altitude or flight level without a proper ATC clearance. When weather conditions encountered are so severe that an immediate deviation is determined to be necessary and time will not permit approval by ATC, the pilot’s emergency authority may be exercised.

3. When the pilot requests clearance for a route deviation or for an ATC radar vector, the controller must evaluate the air traffic picture in the affected area, and coordinate with other controllers (if ATC jurisdictional boundaries may be crossed) before replying to the request.

4. It should be remembered that the controller’s primary function is to provide safe separation between aircraft. Any additional service, such as weather avoidance assistance, can only be provided to the extent that it does not derogate the primary function. It’s also worth noting that the separation workload is generally greater than normal when weather disrupts the usual flow of traffic. ATC radar limitations and frequency congestion may also be a factor in limiting the controller’s capability to provide additional service.

5. It is very important, therefore, that the request for deviation or radar vector be forwarded to ATC as far in advance as possible. Delay in submitting it may delay or even preclude ATC approval or require that additional restrictions be placed on the clearance. Insofar as possible the following information should

be furnished to ATC when requesting clearance to detour around weather activity:

(a) Proposed point where detour will commence.

(b) Proposed route and extent of detour (direction and distance).

(c) Point where original route will be resumed.

(d) Flight conditions (IFR or VFR).

(e) Any further deviation that may become necessary as the flight progresses.

(f) Advise if the aircraft is equipped with functioning airborne radar.

6. To a large degree, the assistance that might be rendered by ATC will depend upon the weather information available to controllers. Due to the extremely transitory nature of severe weather situations, the controller’s weather information may be of only limited value if based on weather observed on radar only. Frequent updates by pilots giving specific information as to the area affected, altitudes, intensity and nature of the severe weather can be of considerable value. Such reports are relayed by radio or phone to other pilots and controllers and also receive widespread teletypewriter dissemination.

7. Obtaining IFR clearance or an ATC radar vector to circumnavigate severe weather can often be accommodated more readily in the en route areas away from terminals because there is usually less congestion and, therefore, offer greater freedom of action. In terminal areas, the problem is more acute because of traffic density, ATC coordination requirements, complex departure and arrival routes, adjacent airports, etc. As a consequence, controllers are less likely to be able to accommodate all requests for weather detours in a terminal area or be in a position to volunteer such routing to the pilot. Nevertheless, pilots should not hesitate to advise controllers of any observed severe weather and should specifically advise controllers if they desire circumnavigation of observed weather.

c. Procedures for Weather Deviations and Other Contingencies in Oceanic Controlled Airspace.

1. When the pilot initiates communications with ATC, rapid response may be obtained by stating “WEATHER DEVIATION REQUIRED” to indicate

priority is desired on the frequency and for ATC response.

2. The pilot still retains the option of initiating the communications using the urgency call “PAN–PAN” 3 times to alert all listening parties of a special handling condition which will receive ATC priority for issuance of a clearance or assistance.

3. ATC will:

(a) Approve the deviation.

(b) Provide vertical separation and then approve the deviation; or

(c) If ATC is unable to establish vertical separation, ATC must advise the pilot that standard separation cannot be applied; provide essential traffic information for all affected aircraft, to the extent practicable; and if possible, suggest a course of action. ATC may suggest that the pilot climb or descend to a contingency altitude (1,000 feet above or below that assigned if operating above FL 290; 500 feet above or below that assigned if operating at or below FL 290).

PHRASEOLOGY–

STANDARD SEPARATION NOT AVAILABLE, DEVIATE AT PILOT’S DISCRETION; SUGGEST CLIMB (or descent) TO (appropriate altitude); TRAFFIC (position and altitude); REPORT DEVIATION COMPLETE.

4. The pilot will follow the ATC advisory altitude when approximately 10 NM from track as well as execute the procedures detailed in paragraph 7–1–14c5.

5. If contact cannot be established or revised ATC clearance or advisory is not available and deviation from track is required, the pilot must take the following actions:

(a) If possible, deviate away from an organized track or route system.

(b) Broadcast aircraft position and intentions on the frequency in use, as well as on frequency 121.5 MHz at suitable intervals stating: flight identification (operator call sign), flight level, track code or ATS route designator, and extent of deviation expected.

(c) Watch for conflicting traffic both visually and by reference to TCAS (if equipped).

(d) Turn on aircraft exterior lights.

(e) Deviations of less than 10 NM should REMAIN at ASSIGNED altitude. Otherwise, when the aircraft is approximately 10 NM from track, initiate an altitude change based on the following criteria:

TBL 7-1-5

Route Centerline/Track	Deviations >10 NM	Altitude Change
EAST (000°–179° magnetic)	LEFT	DESCEND 300 ft
	RIGHT	CLIMB 300 ft
WEST (180°–359° magnetic)	LEFT	CLIMB 300 ft
	RIGHT	DESCEND 300 ft
<i>Pilot Memory Slogan: “East right up, West right down.”</i>		

(f) When returning to track, be at assigned flight level when the aircraft is within approximately 10 NM of centerline.

(g) If contact was not established prior to deviating, continue to attempt to contact ATC to obtain a clearance. If contact was established, continue to keep ATC advised of intentions and obtain essential traffic information.

7–1–15. Runway Visual Range (RVR)

There are currently two configurations of RVR in the NAS commonly identified as Taskers and New Generation RVR. The Taskers are the existing configuration which uses transmissometer technology. The New Generation RVRs were deployed in November 1994 and use forward scatter technology. The New Generation RVRs are currently being deployed in the NAS to replace the existing Taskers.

a. RVR values are measured by transmissometers mounted on 14–foot towers along the runway. A full RVR system consists of:

1. Transmissometer projector and related items.
2. Transmissometer receiver (detector) and related items.
3. Analog
4. recorder.
5. Signal data converter and related items.
6. Remote digital or remote display programmer.

b. The transmissometer projector and receiver are mounted on towers 250 feet apart. A known intensity of light is emitted from the projector and is measured by the receiver. Any obscuring matter such as rain, snow, dust, fog, haze or smoke reduces the light intensity arriving at the receiver. The resultant intensity measurement is then converted to an RVR value by the signal data converter. These values are displayed by readout equipment in the associated air traffic facility and updated approximately once every minute for controller issuance to pilots.

c. The signal data converter receives information on the high intensity runway edge light setting in use (step 3, 4, or 5); transmission values from the transmissometer and the sensing of day or night conditions. From the three data sources, the system will compute appropriate RVR values.

d. An RVR transmissometer established on a 250 foot baseline provides digital readouts to a minimum of 600 feet, which are displayed in 200 foot increments to 3,000 feet and in 500 foot increments from 3,000 feet to a maximum value of 6,000 feet.

e. RVR values for Category IIIa operations extend down to 700 feet RVR; however, only 600 and 800 feet are reportable RVR increments. The 800 RVR reportable value covers a range of 701 feet to 900 feet and is therefore a valid minimum indication of Category IIIa operations.

f. Approach categories with the corresponding minimum RVR values. (See TBL 7-1-6.)

TBL 7-1-6

Approach Category/Minimum RVR Table

Category	Visibility (RVR)
Nonprecision	2,400 feet
Category I	1,800 feet*
Category II	1,000 feet
Category IIIa	700 feet
Category IIIb	150 feet
Category IIIc	0 feet

* 1,400 feet with special equipment and authorization

g. Ten minute maximum and minimum RVR values for the designated RVR runway are reported in the body of the aviation weather report when the prevailing visibility is less than one mile and/or the RVR is 6,000 feet or less. ATCTs report RVR when

the prevailing visibility is 1 mile or less and/or the RVR is 6,000 feet or less.

h. Details on the requirements for the operational use of RVR are contained in FAA AC 97-1, Runway Visual Range (RVR). Pilots are responsible for compliance with minimums prescribed for their class of operations in the appropriate CFRs and/or operations specifications.

i. RVR values are also measured by forward scatter meters mounted on 14-foot frangible fiberglass poles. A full RVR system consists of:

1. Forward scatter meter with a transmitter, receiver and associated items.
2. A runway light intensity monitor (RLIM).
3. An ambient light sensor (ALS).
4. A data processor unit (DPU).
5. Controller display (CD).

j. The forward scatter meter is mounted on a 14-foot frangible pole. Infrared light is emitted from the transmitter and received by the receiver. Any obscuring matter such as rain, snow, dust, fog, haze or smoke increases the amount of scattered light reaching the receiver. The resulting measurement along with inputs from the runway light intensity monitor and the ambient light sensor are forwarded to the DPU which calculates the proper RVR value. The RVR values are displayed locally and remotely on controller displays.

k. The runway light intensity monitors both the runway edge and centerline light step settings (steps 1 through 5). Centerline light step settings are used for CAT IIIb operations. Edge Light step settings are used for CAT I, II, and IIIa operations.

l. New Generation RVRs can measure and display RVR values down to the lowest limits of Category IIIb operations (150 feet RVR). RVR values are displayed in 100 feet increments and are reported as follows:

1. 100-foot increments for products below 800 feet.
2. 200-foot increments for products between 800 feet and 3,000 feet.
3. 500-foot increments for products between 3,000 feet and 6,500 feet.
4. 25-meter increments for products below 150 meters.

5. 50-meter increments for products between 150 meters and 800 meters.

6. 100-meter increments for products between 800 meters and 1,200 meters.

7. 200-meter increments for products between 1,200 meters and 2,000 meters.

7-1-16. Reporting of Cloud Heights

a. Ceiling, by definition in the CFRs and as used in aviation weather reports and forecasts, is the height above ground (or water) level of the lowest layer of clouds or obscuring phenomenon that is reported as “broken,” “overcast,” or “obscuration,” e.g., an aerodrome forecast (TAF) which reads “BKN030” refers to height above ground level. An area forecast which reads “BKN030” indicates that the height is above mean sea level.

REFERENCE-

AIM, Paragraph 7-1-30, Key to Aerodrome Forecast (TAF) and Aviation Routine Weather Report (METAR), defines “broken,” “overcast,” and “obscuration.”

b. Pilots usually report height values above MSL, since they determine heights by the altimeter. This is taken in account when disseminating and otherwise applying information received from pilots. (“Ceiling” heights are always above ground level.) In reports disseminated as PIREPs, height references are given the same as received from pilots, that is, above MSL.

c. In area forecasts or inflight advisories, ceilings are denoted by the contraction “CIG” when used with sky cover symbols as in “LWRG TO CIG OVC005,” or the contraction “AGL” after, the forecast cloud height value. When the cloud base is given in height above MSL, it is so indicated by the contraction “MSL” or “ASL” following the height value. The heights of clouds tops, freezing level, icing, and turbulence are always given in heights above ASL or MSL.

7-1-17. Reporting Prevailing Visibility

a. Surface (horizontal) visibility is reported in METAR reports in terms of statute miles and increments thereof; e.g., $\frac{1}{16}$, $\frac{1}{8}$, $\frac{3}{16}$, $\frac{1}{4}$, $\frac{5}{16}$, $\frac{3}{8}$, $\frac{1}{2}$, $\frac{5}{8}$, $\frac{3}{4}$, $\frac{7}{8}$, 1, $1\frac{1}{8}$, etc. (Visibility reported by an unaugmented automated site is reported differently than in a manual report, i.e., ASOS/AWOS: 0, $\frac{1}{16}$, $\frac{1}{8}$, $\frac{1}{4}$, $\frac{1}{2}$, $\frac{3}{4}$, 1, $1\frac{1}{4}$, $1\frac{1}{2}$, $1\frac{3}{4}$, 2, $2\frac{1}{2}$, 3, 4, 5, etc., AWOS:

$M\frac{1}{4}$, $\frac{1}{4}$, $\frac{1}{2}$, $\frac{3}{4}$, 1, $1\frac{1}{4}$, $1\frac{1}{2}$, $1\frac{3}{4}$, 2, $2\frac{1}{2}$, 3, 4, 5, etc.) Visibility is determined through the ability to see and identify preselected and prominent objects at a known distance from the usual point of observation. Visibilities which are determined to be less than 7 miles, identify the obscuring atmospheric condition; e.g., fog, haze, smoke, etc., or combinations thereof.

b. Prevailing visibility is the greatest visibility equaled or exceeded throughout at least one half of the horizon circle, not necessarily contiguous. Segments of the horizon circle which may have a significantly different visibility may be reported in the remarks section of the weather report; i.e., the southeastern quadrant of the horizon circle may be determined to be 2 miles in mist while the remaining quadrants are determined to be 3 miles in mist.

c. When the prevailing visibility at the usual point of observation, or at the tower level, is less than 4 miles, certificated tower personnel will take visibility observations in addition to those taken at the usual point of observation. The lower of these two values will be used as the prevailing visibility for aircraft operations.

7-1-18. Estimating Intensity of Rain and Ice Pellets

a. Rain

1. **Light.** From scattered drops that, regardless of duration, do not completely wet an exposed surface up to a condition where individual drops are easily seen.

2. **Moderate.** Individual drops are not clearly identifiable; spray is observable just above pavements and other hard surfaces.

3. **Heavy.** Rain seemingly falls in sheets; individual drops are not identifiable; heavy spray to height of several inches is observed over hard surfaces.

b. Ice Pellets

1. **Light.** Scattered pellets that do not completely cover an exposed surface regardless of duration. Visibility is not affected.

2. **Moderate.** Slow accumulation on ground. Visibility reduced by ice pellets to less than 7 statute miles.

3. Heavy. Rapid accumulation on ground. Visibility reduced by ice pellets to less than 3 statute miles.

7-1-19. Estimating Intensity of Snow or Drizzle (Based on Visibility)

- a. **Light.** Visibility more than $\frac{1}{2}$ statute mile.
- b. **Moderate.** Visibility from more than $\frac{1}{4}$ statute mile to $\frac{1}{2}$ statute mile.
- c. **Heavy.** Visibility $\frac{1}{4}$ statute mile or less.

7-1-20. Pilot Weather Reports (PIREPs)

a. FAA air traffic facilities are required to solicit PIREPs when the following conditions are reported or forecast: ceilings at or below 5,000 feet; visibility at or below 5 miles (surface or aloft); thunderstorms and related phenomena; icing of light degree or greater; turbulence of moderate degree or greater; wind shear and reported or forecast volcanic ash clouds.

b. Pilots are urged to cooperate and promptly volunteer reports of these conditions and other atmospheric data such as: cloud bases, tops and layers; flight visibility; precipitation; visibility restrictions such as haze, smoke and dust; wind at altitude; and temperature aloft.

c. PIREPs should be given to the ground facility with which communications are established; i.e., FSS, ARTCC, or terminal ATC. One of the primary duties of the Inflight position is to serve as a collection point for the exchange of PIREPs with en route aircraft.

d. If pilots are not able to make PIREPs by radio, reporting upon landing of the inflight conditions encountered to the nearest FSS or Weather Forecast Office will be helpful. Some of the uses made of the reports are:

1. The ATCT uses the reports to expedite the flow of air traffic in the vicinity of the field and for hazardous weather avoidance procedures.
2. The FSS uses the reports to brief other pilots, to provide inflight advisories, and weather avoidance information to en route aircraft.
3. The ARTCC uses the reports to expedite the flow of en route traffic, to determine most favorable

altitudes, and to issue hazardous weather information within the center's area.

4. The NWS uses the reports to verify or amend conditions contained in aviation forecast and advisories. In some cases, pilot reports of hazardous conditions are the triggering mechanism for the issuance of advisories. They also use the reports for pilot weather briefings.

5. The NWS, other government organizations, the military, and private industry groups use PIREPs for research activities in the study of meteorological phenomena.

6. All air traffic facilities and the NWS forward the reports received from pilots into the weather distribution system to assure the information is made available to all pilots and other interested parties.

e. The FAA, NWS, and other organizations that enter PIREPs into the weather reporting system use the format listed in TBL 7-1-7. Items 1 through 6 are included in all transmitted PIREPs along with one or more of items 7 through 13. Although the PIREP should be as complete and concise as possible, pilots should not be overly concerned with strict format or phraseology. The important thing is that the information is relayed so other pilots may benefit from your observation. If a portion of the report needs clarification, the ground station will request the information. Completed PIREPs will be transmitted to weather circuits as in the following examples:

EXAMPLE-

1. *KCMH UA /OV APE 230010/TM 1516/FL085/TP BE20/SK BKN065/WX FV03SM HZ FU/TA 20/TB LGT*

NOTE-

1. *One zero miles southwest of Appleton VOR; time 1516 UTC; altitude eight thousand five hundred; aircraft type BE200; bases of the broken cloud layer is six thousand five hundred; flight visibility 3 miles with haze and smoke; air temperature 20 degrees Celsius; light turbulence.*

EXAMPLE-

2. *KCRW UV /OV KBKW 360015-KCRW/TM 1815/FL120//TP BE99/SK IMC/WX RA/TA M08 /WV 290030/TB LGT-MDT/IC LGT RIME/RM MDT MXD ICG DURC KROA NWBND FL080-100 1750Z*

NOTE-

2. *From 15 miles north of Beckley VOR to Charleston VOR; time 1815 UTC; altitude 12,000 feet; type aircraft, BE-99; in clouds; rain; temperature minus 8 Celsius; wind 290 degrees magnetic at 30 knots; light to moderate turbulence; light rime icing during climb*

northwestbound from Roanoke, VA, between 8,000 and 10,000 feet at 1750 UTC.

can refer to the current version of AC 00-45, Aviation Weather Services.

- f. For more detailed information on PIREPS, users

TBL 7-1-7
PIREP Element Code Chart

	PIREP ELEMENT	PIREP CODE	CONTENTS
1.	3-letter station identifier	XXX	Nearest weather reporting location to the reported phenomenon
2.	Report type	UA or UUA	Routine or Urgent PIREP
3.	Location	/OV	In relation to a VOR
4.	Time	/TM	Coordinated Universal Time
5.	Altitude	/FL	Essential for turbulence and icing reports
6.	Type Aircraft	/TP	Essential for turbulence and icing reports
7.	Sky cover	/SK	Cloud height and coverage (sky clear, few, scattered, broken, or overcast)
8.	Weather	/WX	Flight visibility, precipitation, restrictions to visibility, etc.
9.	Temperature	/TA	Degrees Celsius
10.	Wind	/WV	Direction in degrees magnetic north and speed in knots
11.	Turbulence	/TB	See AIM paragraph 7-1-23
12.	Icing	/IC	See AIM paragraph 7-1-21
13.	Remarks	/RM	For reporting elements not included or to clarify previously reported items

7-1-21. PIREPs Relating to Airframe Icing

a. The effects of ice on aircraft are cumulative-thrust is reduced, drag increases, lift lessens, and weight increases. The results are an increase in stall speed and a deterioration of aircraft performance. In extreme cases, 2 to 3 inches of ice can form on the leading edge of the airfoil in less than 5 minutes. It takes but 1/2 inch of ice to reduce the lifting power of some aircraft by 50 percent and increases the frictional drag by an equal percentage.

b. A pilot can expect icing when flying in visible precipitation, such as rain or cloud droplets, and the temperature is between +02 and -10 degrees Celsius. When icing is detected, a pilot should do one of two things, particularly if the aircraft is not equipped with deicing equipment; get out of the area of precipitation; or go to an altitude where the temperature is above freezing. This “warmer” altitude may not always be a lower altitude. Proper preflight action includes obtaining information on the freezing level and the above freezing levels in precipitation areas. Report icing to ATC, and if operating IFR, request new routing or altitude if icing will be a hazard. Be sure to give the type of aircraft to

ATC when reporting icing. The following describes how to report icing conditions.

1. Trace. Ice becomes perceptible. Rate of accumulation slightly greater than sublimation. Deicing/anti-icing equipment is not utilized unless encountered for an extended period of time (over 1 hour).

2. Light. The rate of accumulation may create a problem if flight is prolonged in this environment (over 1 hour). Occasional use of deicing/anti-icing equipment removes/prevents accumulation. It does not present a problem if the deicing/anti-icing equipment is used.

3. Moderate. The rate of accumulation is such that even short encounters become potentially hazardous and use of deicing/anti-icing equipment or flight diversion is necessary.

4. Severe. The rate of accumulation is such that ice protection systems fail to remove the accumulation of ice, or ice accumulates in locations not normally prone to icing, such as areas aft of protected surfaces and any other areas identified by the

manufacturer. Immediate exit from the condition is necessary.

NOTE-

Severe icing is aircraft dependent, as are the other categories of icing intensity. Severe icing may occur at any accumulation rate.

EXAMPLE-

Pilot report: give aircraft identification, location, time (UTC), intensity of type, altitude/FL, aircraft type, indicated air speed (IAS), and outside air temperature (OAT).

NOTE-

1. *Rime ice.* Rough, milky, opaque ice formed by the instantaneous freezing of small supercooled water droplets.

2. *Clear ice.* A glossy, clear, or translucent ice formed by the relatively slow freezing of large supercooled water droplets.

3. The OAT should be requested by the FSS or ATC if not included in the PIREP.

7-1-22. Definitions of Inflight Icing Terms

See TBL 7-1-8, Icing Types, and TBL 7-1-9, Icing Conditions.

**TBL 7-1-8
Icing Types**

Clear Ice	See Glaze Ice.
Glaze Ice	Ice, sometimes clear and smooth, but usually containing some air pockets, which results in a lumpy translucent appearance. Glaze ice results from supercooled drops/droplets striking a surface but not freezing rapidly on contact. Glaze ice is denser, harder, and sometimes more transparent than rime ice. Factors, which favor glaze formation, are those that favor slow dissipation of the heat of fusion (i.e., slight supercooling and rapid accretion). With larger accretions, the ice shape typically includes “horns” protruding from unprotected leading edge surfaces. It is the ice shape, rather than the clarity or color of the ice, which is most likely to be accurately assessed from the cockpit. The terms “clear” and “glaze” have been used for essentially the same type of ice accretion, although some reserve “clear” for thinner accretions which lack horns and conform to the airfoil.
Intercycle Ice	Ice which accumulates on a protected surface between actuation cycles of a deicing system.
Known or Observed or Detected Ice Accretion	Actual ice observed visually to be on the aircraft by the flight crew or identified by on-board sensors.
Mixed Ice	Simultaneous appearance or a combination of rime and glaze ice characteristics. Since the clarity, color, and shape of the ice will be a mixture of rime and glaze characteristics, accurate identification of mixed ice from the cockpit may be difficult.
Residual Ice	Ice which remains on a protected surface immediately after the actuation of a deicing system.
Rime Ice	A rough, milky, opaque ice formed by the rapid freezing of supercooled drops/droplets after they strike the aircraft. The rapid freezing results in air being trapped, giving the ice its opaque appearance and making it porous and brittle. Rime ice typically accretes along the stagnation line of an airfoil and is more regular in shape and conformal to the airfoil than glaze ice. It is the ice shape, rather than the clarity or color of the ice, which is most likely to be accurately assessed from the cockpit.
Runback Ice	Ice which forms from the freezing or refreezing of water leaving protected surfaces and running back to unprotected surfaces.
Note- Ice types are difficult for the pilot to discern and have uncertain effects on an airplane in flight. Ice type definitions will be included in the AIM for use in the “Remarks” section of the PIREP and for use in forecasting.	

TBL 7-1-9
Icing Conditions

Appendix C Icing Conditions	Appendix C (14 CFR, Part 25 and 29) is the certification icing condition standard for approving ice protection provisions on aircraft. The conditions are specified in terms of altitude, temperature, liquid water content (LWC), representative droplet size (mean effective drop diameter [MED]), and cloud horizontal extent.
Forecast Icing Conditions	Environmental conditions expected by a National Weather Service or an FAA-approved weather provider to be conducive to the formation of inflight icing on aircraft.
Freezing Drizzle (FZDZ)	Drizzle is precipitation at ground level or aloft in the form of liquid water drops which have diameters less than 0.5 mm and greater than 0.05 mm. Freezing drizzle is drizzle that exists at air temperatures less than 0°C (supercooled), remains in liquid form, and freezes upon contact with objects on the surface or airborne.
Freezing Precipitation	Freezing precipitation is freezing rain or freezing drizzle falling through or outside of visible cloud.
Freezing Rain (FZRA)	Rain is precipitation at ground level or aloft in the form of liquid water drops which have diameters greater than 0.5 mm. Freezing rain is rain that exists at air temperatures less than 0°C (supercooled), remains in liquid form, and freezes upon contact with objects on the ground or in the air.
Icing in Cloud	Icing occurring within visible cloud. Cloud droplets (diameter < 0.05 mm) will be present; freezing drizzle and/or freezing rain may or may not be present.
Icing in Precipitation	Icing occurring from an encounter with freezing precipitation, that is, supercooled drops with diameters exceeding 0.05 mm, within or outside of visible cloud.
Known Icing Conditions	Atmospheric conditions in which the formation of ice is observed or detected in flight. <i>Note—</i> <i>Because of the variability in space and time of atmospheric conditions, the existence of a report of observed icing does not assure the presence or intensity of icing conditions at a later time, nor can a report of no icing assure the absence of icing conditions at a later time.</i>
Potential Icing Conditions	Atmospheric icing conditions that are typically defined by airframe manufacturers relative to temperature and visible moisture that may result in aircraft ice accretion on the ground or in flight. The potential icing conditions are typically defined in the Airplane Flight Manual or in the Airplane Operation Manual.
Supercooled Drizzle Drops (SCDD)	Synonymous with freezing drizzle aloft.
Supercooled Drops or /Droplets	Water drops/droplets which remain unfrozen at temperatures below 0°C. Supercooled drops are found in clouds, freezing drizzle, and freezing rain in the atmosphere. These drops may impinge and freeze after contact on aircraft surfaces.
Supercooled Large Drops (SLD)	Liquid droplets with diameters greater than 0.05 mm at temperatures less than 0°C, i.e., freezing rain or freezing drizzle.

7-1-23. PIREPs Relating to Turbulence

a. When encountering turbulence, pilots are urgently requested to report such conditions to ATC as soon as practicable. PIREPs relating to turbulence should state:

1. Aircraft location.
2. Time of occurrence in UTC.
3. Turbulence intensity.
4. Whether the turbulence occurred in or near clouds.

5. Aircraft altitude or flight level.
6. Type of aircraft.
7. Duration of turbulence.

EXAMPLE-

1. *Over Omaha, 1232Z, moderate turbulence in clouds at Flight Level three one zero, Boeing 707.*
2. *From five zero miles south of Albuquerque to three zero miles north of Phoenix, 1250Z, occasional moderate chop at Flight Level three three zero, DC8.*

b. Duration and classification of intensity should be made using TBL 7-1-10.

TBL 7-1-10

Turbulence Reporting Criteria Table

Intensity	Aircraft Reaction	Reaction Inside Aircraft	Reporting Term-Definition
Light	Turbulence that momentarily causes slight, erratic changes in altitude and/or attitude (pitch, roll, yaw). Report as Light Turbulence ; ¹ or Turbulence that causes slight, rapid and somewhat rhythmic bumpiness without appreciable changes in altitude or attitude. Report as Light Chop .	Occupants may feel a slight strain against seat belts or shoulder straps. Unsecured objects may be displaced slightly. Food service may be conducted and little or no difficulty is encountered in walking.	Occasional-Less than 1/3 of the time. Intermittent-1/3 to 2/3. Continuous-More than 2/3.
Moderate	Turbulence that is similar to Light Turbulence but of greater intensity. Changes in altitude and/or attitude occur but the aircraft remains in positive control at all times. It usually causes variations in indicated airspeed. Report as Moderate Turbulence ; ¹ or Turbulence that is similar to Light Chop but of greater intensity. It causes rapid bumps or jolts without appreciable changes in aircraft altitude or attitude. Report as Moderate Chop . ¹	Occupants feel definite strains against seat belts or shoulder straps. Unsecured objects are dislodged. Food service and walking are difficult.	<p style="text-align: center;">NOTE</p> <p>1. Pilots should report location(s), time (UTC), intensity, whether in or near clouds, altitude, type of aircraft and, when applicable, duration of turbulence.</p> <p>2. Duration may be based on time between two locations or over a single location. All locations should be readily identifiable.</p>
Severe	Turbulence that causes large, abrupt changes in altitude and/or attitude. It usually causes large variations in indicated airspeed. Aircraft may be momentarily out of control. Report as Severe Turbulence . ¹	Occupants are forced violently against seat belts or shoulder straps. Unsecured objects are tossed about. Food Service and walking are impossible.	
Extreme	Turbulence in which the aircraft is violently tossed about and is practically impossible to control. It may cause structural damage. Report as Extreme Turbulence . ¹		<p style="text-align: center;">EXAMPLES:</p> <p>a. Over Omaha. 1232Z, Moderate Turbulence, in cloud, Flight Level 310, B707.</p> <p>b. From 50 miles south of Albuquerque to 30 miles north of Phoenix, 1210Z to 1250Z, occasional Moderate Chop, Flight Level 330, DC8.</p>
<p>¹ High level turbulence (normally above 15,000 feet ASL) not associated with cumuliform cloudiness, including thunderstorms, should be reported as CAT (clear air turbulence) preceded by the appropriate intensity, or light or moderate chop.</p>			

7-1-24. Wind Shear PIREPs

a. Because unexpected changes in wind speed and direction can be hazardous to aircraft operations at low altitudes on approach to and departing from airports, pilots are urged to promptly volunteer reports to controllers of wind shear conditions they encounter. An advance warning of this information will assist other pilots in avoiding or coping with a wind shear on approach or departure.

b. When describing conditions, use of the terms “negative” or “positive” wind shear should be avoided. PIREPs of “negative wind shear on final,” intended to describe loss of airspeed and lift, have been interpreted to mean that no wind shear was encountered. The recommended method for wind shear reporting is to state the loss or gain of airspeed and the altitudes at which it was encountered.

EXAMPLE-

1. *Denver Tower, Cessna 1234 encountered wind shear, loss of 20 knots at 400.*

2. *Tulsa Tower, American 721 encountered wind shear on final, gained 25 knots between 600 and 400 feet followed by loss of 40 knots between 400 feet and surface.*

1. Pilots who are not able to report wind shear in these specific terms are encouraged to make reports in terms of the effect upon their aircraft.

EXAMPLE-

Miami Tower, Gulfstream 403 Charlie encountered an abrupt wind shear at 800 feet on final, max thrust required.

2. Pilots using Inertial Navigation Systems (INSS) should report the wind and altitude both above and below the shear level.

7-1-25. Clear Air Turbulence (CAT) PIREPs

CAT has become a very serious operational factor to flight operations at all levels and especially to jet

traffic flying in excess of 15,000 feet. The best available information on this phenomenon must come from pilots via the PIREP reporting procedures. All pilots encountering CAT conditions are urgently requested to report time, location, and intensity (light, moderate, severe, or extreme) of the element to the FAA facility with which they are maintaining radio contact. If time and conditions permit, elements should be reported according to the standards for other PIREPs and position reports.

REFERENCE-

AIM, Paragraph 7-1-23, PIREPs Relating to Turbulence

7-1-26. Microbursts

a. Relatively recent meteorological studies have confirmed the existence of microburst phenomenon. Microbursts are small scale intense downdrafts which, on reaching the surface, spread outward in all directions from the downdraft center. This causes the presence of both vertical and horizontal wind shears that can be extremely hazardous to all types and categories of aircraft, especially at low altitudes. Due to their small size, short life span, and the fact that they can occur over areas without surface precipitation, microbursts are not easily detectable using conventional weather radar or wind shear alert systems.

b. Parent clouds producing microburst activity can be any of the low or middle layer convective cloud types. Note, however, that microbursts commonly occur within the heavy rain portion of thunderstorms, and in much weaker, benign appearing convective cells that have little or no precipitation reaching the ground.

FIG 7-1-12
Evolution of a Microburst

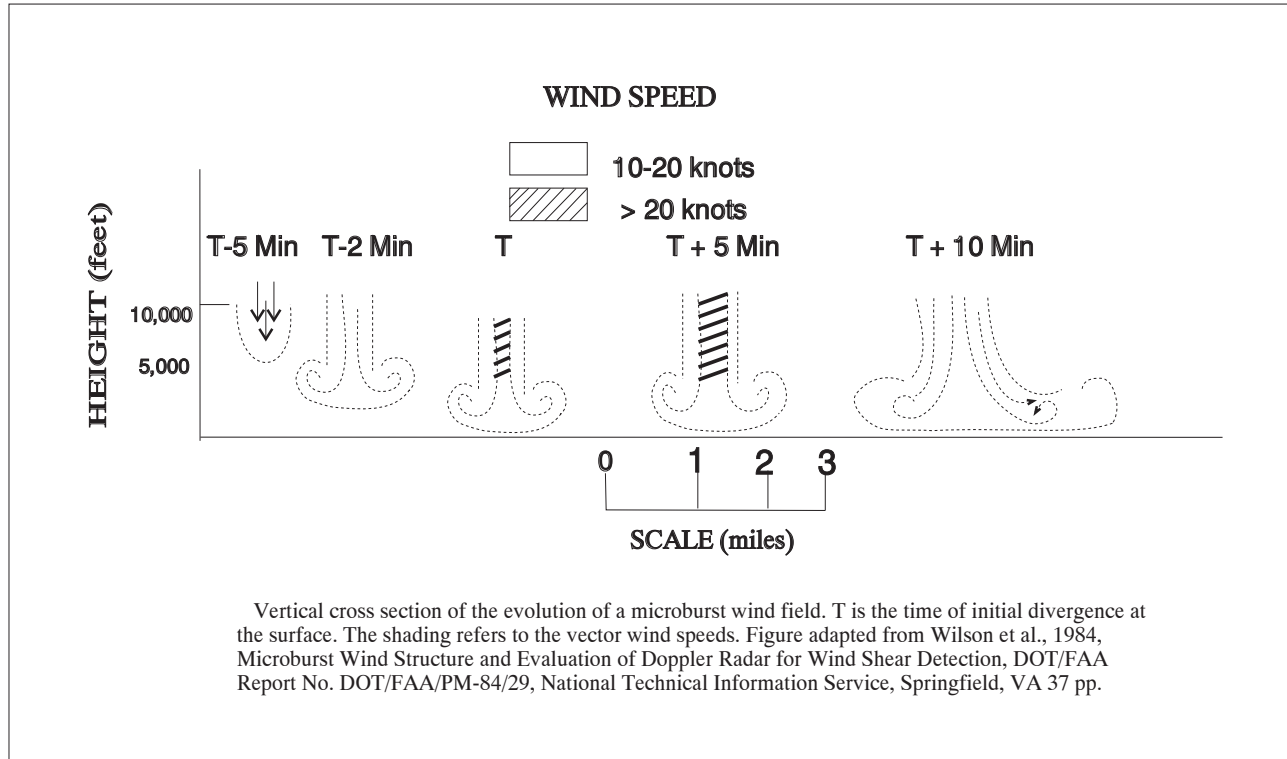

c. The life cycle of a microburst as it descends in a convective rain shaft is seen in FIG 7-1-12. An important consideration for pilots is the fact that the microburst intensifies for about 5 minutes after it strikes the ground.

d. Characteristics of microbursts include:

1. Size. The microburst downdraft is typically less than 1 mile in diameter as it descends from the cloud base to about 1,000–3,000 feet above the ground. In the transition zone near the ground, the downdraft changes to a horizontal outflow that can extend to approximately 2 1/2 miles in diameter.

2. Intensity. The downdrafts can be as strong as 6,000 feet per minute. Horizontal winds near the surface can be as strong as 45 knots resulting in a 90 knot shear (headwind to tailwind change for a traversing aircraft) across the microburst. These strong horizontal winds occur within a few hundred feet of the ground.

3. Visual Signs. Microbursts can be found almost anywhere that there is convective activity. They may be embedded in heavy rain associated with a thunderstorm or in light rain in benign appearing virga. When there is little or no precipitation at the surface accompanying the microburst, a ring of blowing dust may be the only visual clue of its existence.

4. Duration. An individual microburst will seldom last longer than 15 minutes from the time it strikes the ground until dissipation. The horizontal winds continue to increase during the first 5 minutes with the maximum intensity winds lasting approximately 2–4 minutes. Sometimes microbursts are concentrated into a line structure, and under these conditions, activity may continue for as long as an hour. Once microburst activity starts, multiple microbursts in the same general area are not uncommon and should be expected.

**FIG 7-1-13
Microburst Encounter During Takeoff**

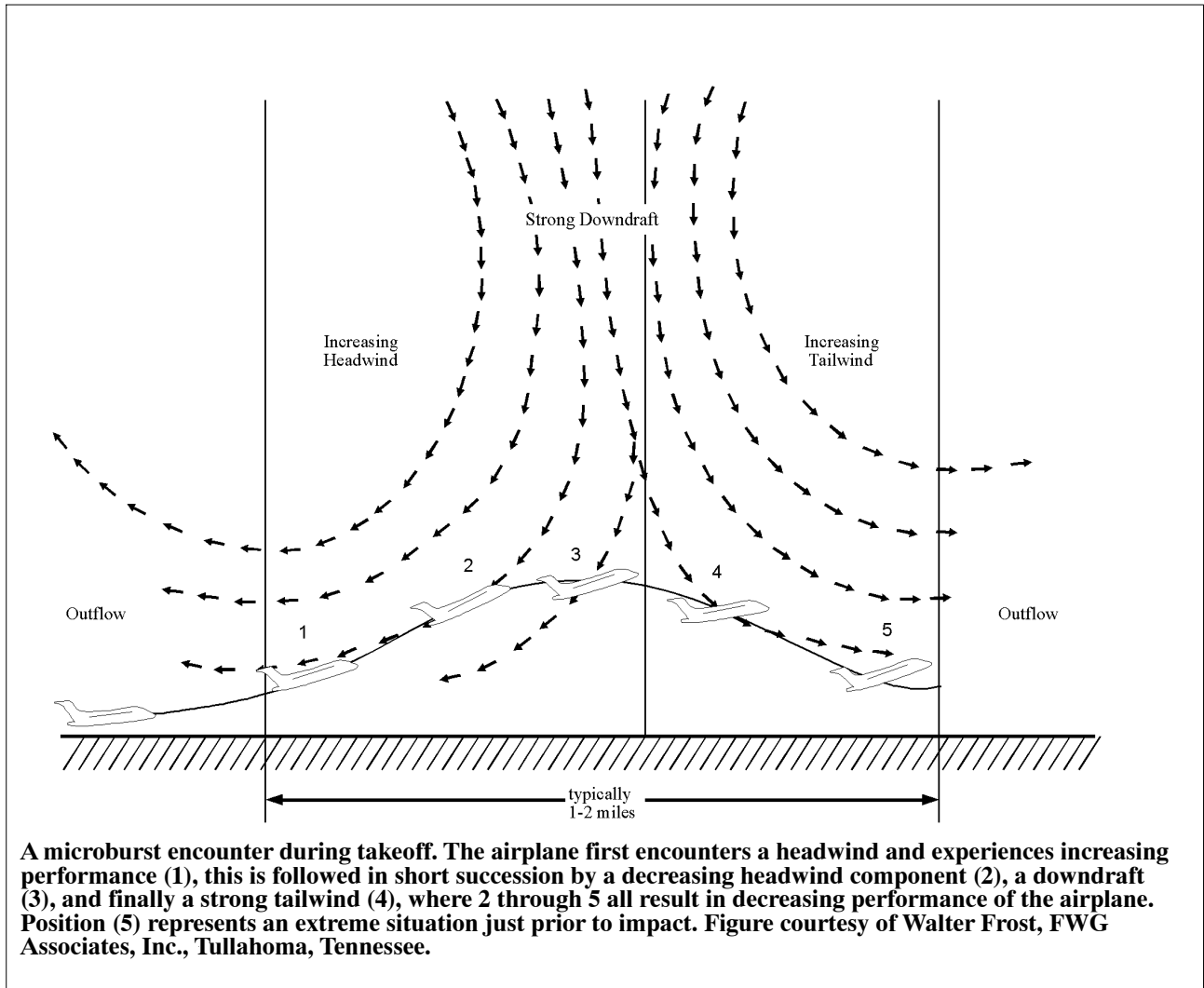

e. Microburst wind shear may create a severe hazard for aircraft within 1,000 feet of the ground, particularly during the approach to landing and landing and take-off phases. The impact of a microburst on aircraft which have the unfortunate

experience of penetrating one is characterized in FIG 7-1-13. The aircraft may encounter a headwind (performance increasing) followed by a downdraft and tailwind (both performance decreasing), possibly resulting in terrain impact.

FIG 7-1-14
NAS Wind Shear Product Systems

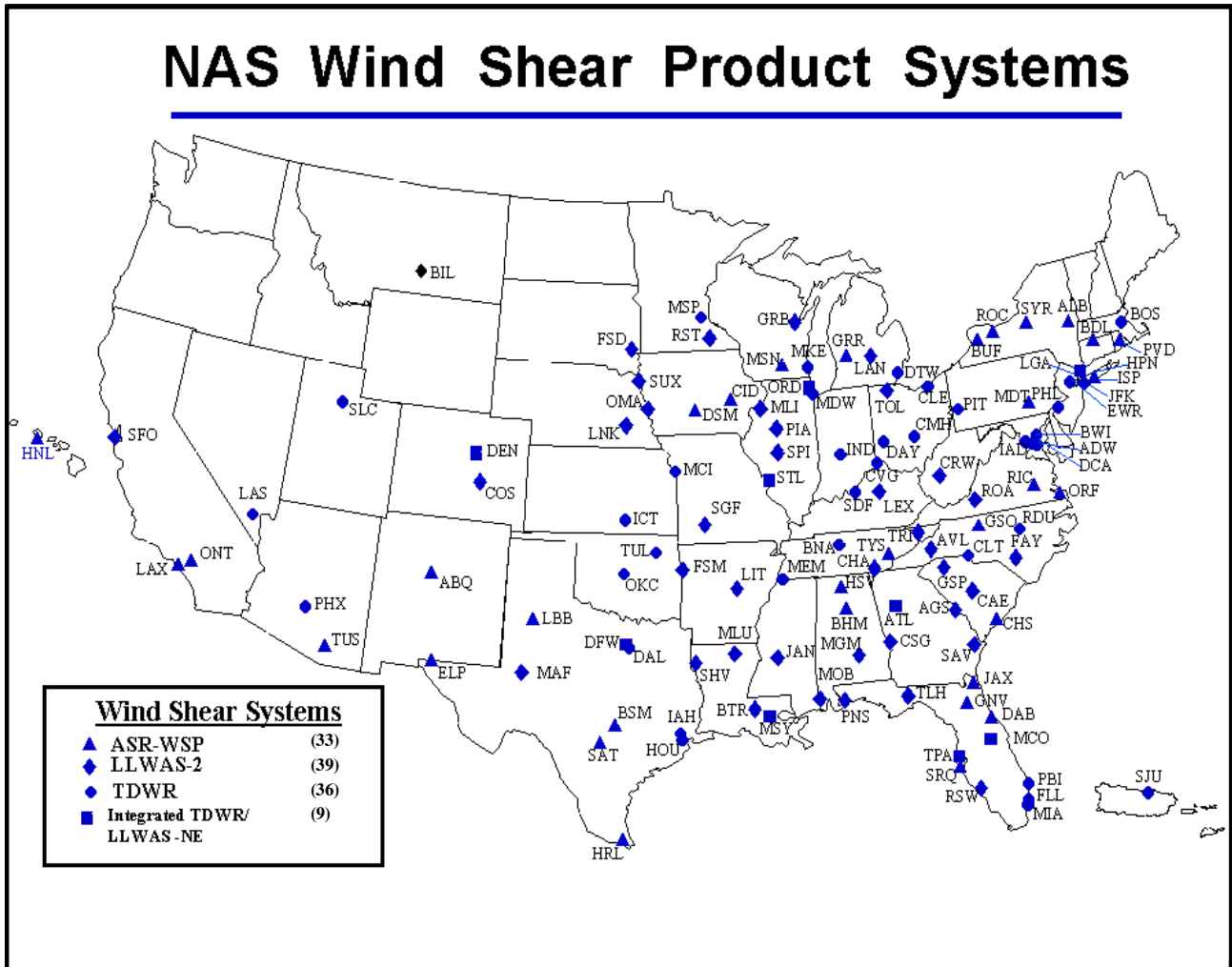

f. Detection of Microbursts, Wind Shear and Gust Fronts.

1. FAA’s Integrated Wind Shear Detection Plan.

(a) The FAA currently employs an integrated plan for wind shear detection that will significantly improve both the safety and capacity of the majority of the airports currently served by the air carriers. This plan integrates several programs, such as the Integrated Terminal Weather System (ITWS), Terminal Doppler Weather Radar (TDWR), Weather System Processor (WSP), and Low Level Wind Shear Alert Systems (LLWAS) into a single strategic

concept that significantly improves the aviation weather information in the terminal area. (See FIG 7-1-14.)

(b) The wind shear/microburst information and warnings are displayed on the ribbon display terminals (RBDT) located in the tower cabs. They are identical (and standardized) in the LLWAS, TDWR and WSP systems, and so designed that the controller does not need to interpret the data, but simply read the displayed information to the pilot. The RBDTs are constantly monitored by the controller to ensure the rapid and timely dissemination of any hazardous event(s) to the pilot.

FIG 7-1-15
LLWAS Siting Criteria

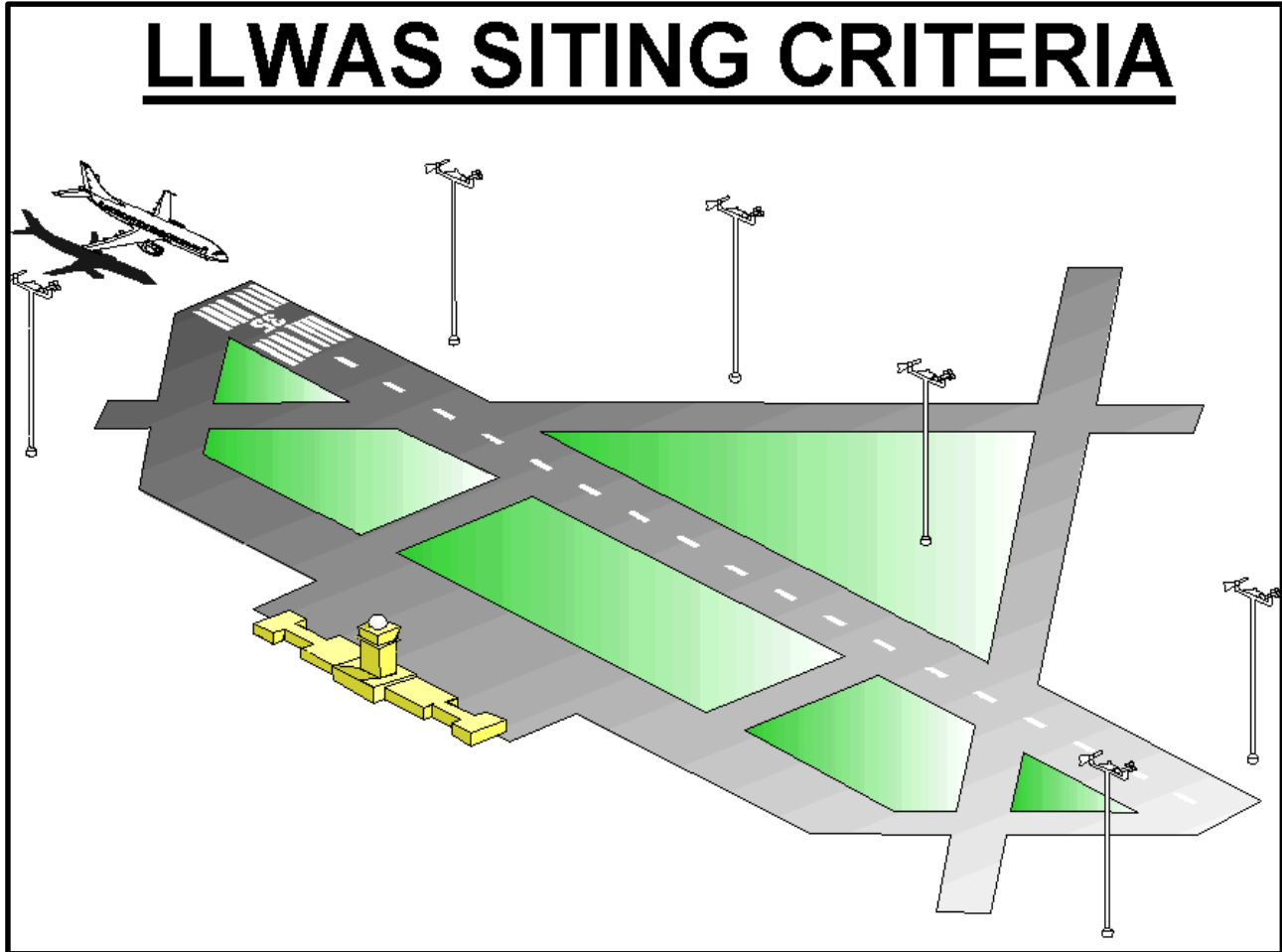

(c) The early detection of a wind shear/micro-burst event, and the subsequent warning(s) issued to an aircraft on approach or departure, will alert the pilot/crew to the potential of, and to be prepared for, a situation that could become very dangerous! Without these warnings, the aircraft may NOT be able to climb out of, or safely transition, the event, resulting in a catastrophe. The air carriers, working with the FAA, have developed specialized training programs using their simulators to train and prepare their pilots on the demanding aircraft procedures required to escape these very dangerous wind shear and/or microburst encounters.

2. Low Level Wind Shear Alert System (LLWAS).

(a) The LLWAS provides wind data and software processes to detect the presence of hazardous wind shear and microbursts in the vicinity of an airport. Wind sensors, mounted on poles sometimes as high as 150 feet, are (ideally) located 2,000 – 3,500 feet, but not more than 5,000 feet, from the centerline of the runway. (See FIG 7-1-15.)

FIG 7-1-16
Warning Boxes

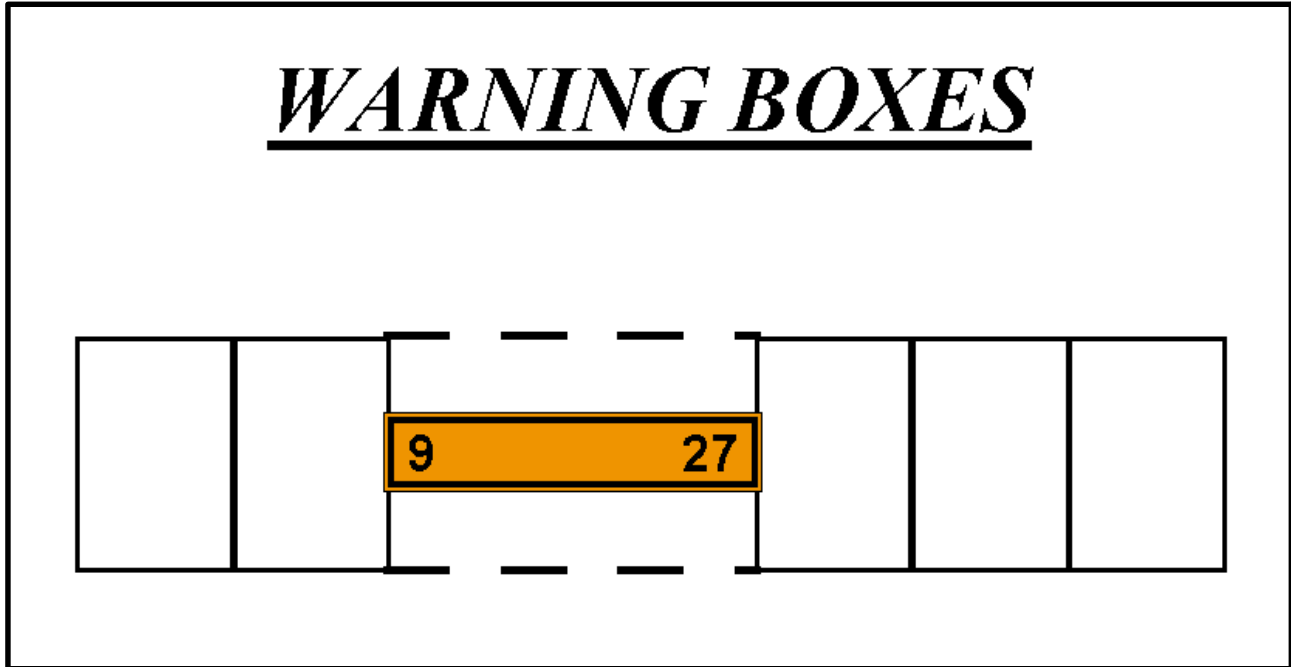

(b) LLWAS was fielded in 1988 at 110 airports across the nation. Many of these systems have been replaced by new TDWR and WSP technology. Eventually all LLWAS systems will be phased out; however, 39 airports will be upgraded to the LLWAS-NE (Network Expansion) system, which employs the very latest software and sensor technology. The new LLWAS-NE systems will not only provide the controller with wind shear warnings and alerts, including wind shear/microburst detection at the airport wind sensor location, but will also provide the location of the hazards relative to the airport runway(s). It will also have the flexibility and capability to grow with the airport as new runways are built. As many as 32 sensors, strategically located around the airport and in relationship to its runway configuration, can be accommodated by the LLWAS-NE network.

3. Terminal Doppler Weather Radar (TDWR).

(a) TDWRs are being deployed at 45 locations across the U.S. Optimum locations for TDWRs are 8 to 12 miles off of the airport proper, and designed to look at the airspace around and over the airport to detect microbursts, gust fronts, wind shifts

and precipitation intensities. TDWR products advise the controller of wind shear and microburst events impacting all runways and the areas $\frac{1}{2}$ mile on either side of the extended centerline of the runways out to 3 miles on final approach and 2 miles out on departure.

(FIG 7-1-16 is a theoretical view of the warning boxes, including the runway, that the software uses in determining the location(s) of wind shear or microbursts). These warnings are displayed (as depicted in the examples in subparagraph 5) on the RBDT.

(b) It is very important to understand what TDWR does NOT DO:

- (1) It **DOES NOT** warn of wind shear outside of the alert boxes (on the arrival and departure ends of the runways);
- (2) It **DOES NOT** detect wind shear that is NOT a microburst or a gust front;
- (3) It **DOES NOT** detect gusty or cross wind conditions; and
- (4) It **DOES NOT** detect turbulence.

However, research and development is continuing on these systems. Future improvements may include such areas as storm motion (movement), improved

gust front detection, storm growth and decay, microburst prediction, and turbulence detection.

(c) TDWR also provides a geographical situation display (GSD) for supervisors and traffic management specialists for planning purposes. The GSD displays (in color) 6 levels of weather (precipitation), gust fronts and predicted storm movement(s). This data is used by the tower supervisor(s), traffic management specialists and controllers to plan for runway changes and arrival/departure route changes in order to both reduce aircraft delays and increase airport capacity.

4. Weather System Processor (WSP).

(a) The WSP provides the controller, supervisor, traffic management specialist, and ultimately the pilot, with the same products as the terminal doppler weather radar (TDWR) at a fraction of the cost of a TDWR. This is accomplished by utilizing new technologies to access the weather channel capabilities of the existing ASR-9 radar located on or near the airport, thus eliminating the requirements for a separate radar location, land acquisition, support facilities and the associated communication landlines and expenses.

(b) The WSP utilizes the same RBDT display as the TDWR and LLWAS, and, just like TDWR, also has a GSD for planning purposes by supervisors, traffic management specialists and controllers. The WSP GSD emulates the TDWR display, i.e., it also depicts 6 levels of precipitation, gust fronts and predicted storm movement, and like the TDWR GSD, is used to plan for runway changes and arrival/departure route changes in order to reduce aircraft delays and to increase airport capacity.

(c) This system is currently under development and is operating in a developmental test status at the Albuquerque, New Mexico, airport. When fielded, the WSP is expected to be installed at

34 airports across the nation, substantially increasing the safety of the American flying public.

5. Operational aspects of LLWAS, TDWR and WSP.

To demonstrate how this data is used by both the controller and the pilot, 3 ribbon display examples and their explanations are presented:

(a) MICROBURST ALERTS

EXAMPLE-

This is what the controller sees on his/her ribbon display in the tower cab.

27A MBA 35K- 2MF 250 20

NOTE-

(See FIG 7-1-17 to see how the TDWR/WSP determines the microburst location).

This is what the controller will say when issuing the alert.

PHRASEOLOGY-

RUNWAY 27 ARRIVAL, MICROBURST ALERT, 35 KT LOSS 2 MILE FINAL, THRESHOLD WIND 250 AT 20.

In plain language, the controller is telling the pilot that on approach to runway 27, there is a microburst alert on the approach lane to the runway, and to anticipate or expect a 35 knot loss of airspeed at approximately 2 miles out on final approach (where it will first encounter the phenomena). With that information, the aircrew is forewarned, and should be prepared to apply wind shear/microburst escape procedures should they decide to continue the approach. Additionally, the surface winds at the airport for landing runway 27 are reported as 250 degrees at 20 knots.

NOTE-

Threshold wind is at pilot's request or as deemed appropriate by the controller.

REFERENCE-

FAA Order JO 7110.65, Paragraph 3-1-8b2(a), Air Traffic Control, Low Level Wind Shear/Microburst Advisories

FIG 7-1-17
Microburst Alert

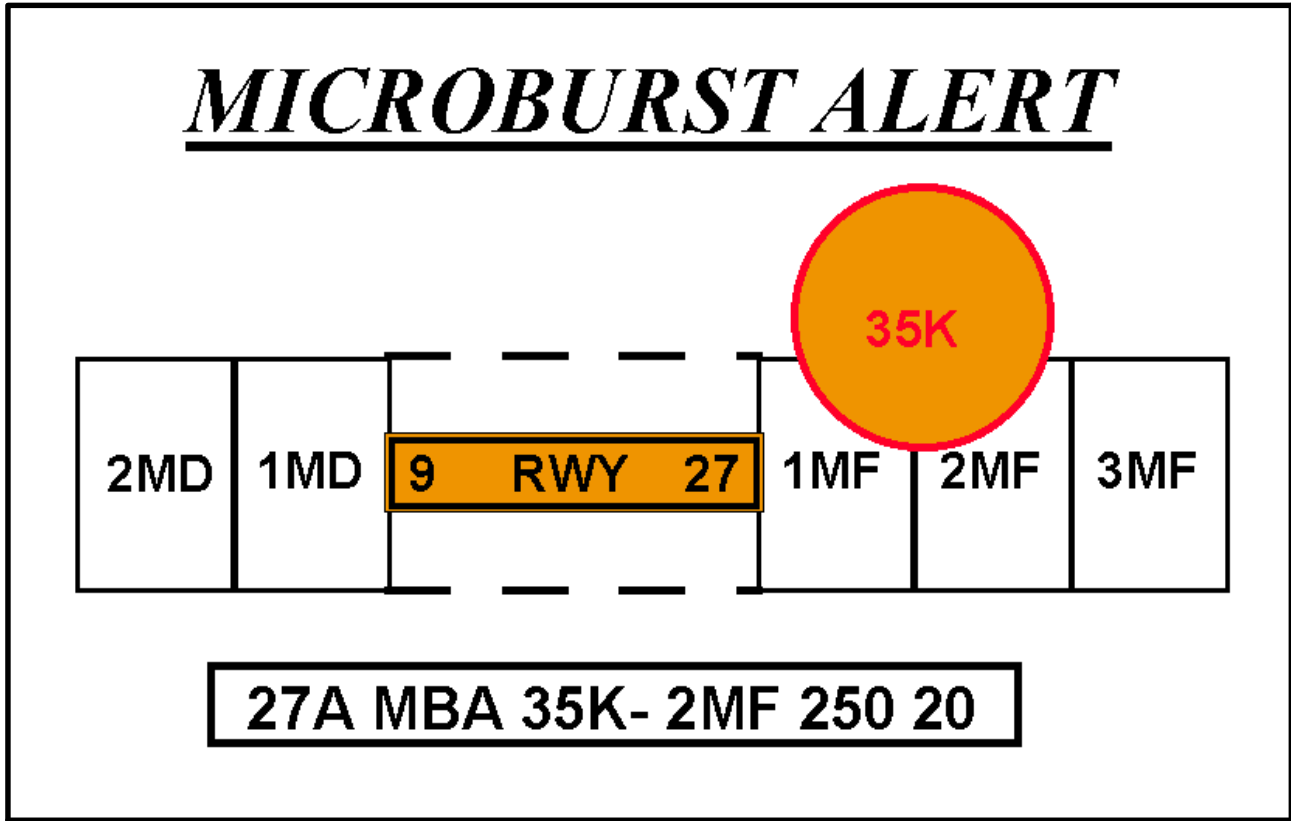

(b) WIND SHEAR ALERTS

EXAMPLE-

This is what the controller sees on his/her ribbon display in the tower cab.

27A WSA 20K- 3MF 200 15

NOTE-

(See FIG 7-1-18 to see how the TDWR/WSP determines the wind shear location).

This is what the controller will say when issuing the alert.

PHRASEOLOGY-

RUNWAY 27 ARRIVAL, WIND SHEAR ALERT, 20 KT LOSS 3 MILE FINAL, THRESHOLD WIND 200 AT 15.

In plain language, the controller is advising the aircraft arriving on runway 27 that at about 3 miles out they can expect to encounter a wind shear condition that will decrease their airspeed by 20 knots and possibly encounter turbulence. Additionally, the airport surface winds for landing runway 27 are reported as 200 degrees at 15 knots.

NOTE-

Threshold wind is at pilot's request or as deemed appropriate by the controller.

REFERENCE-

FAA Order JO 7110.65, Air Traffic Control, Low Level Wind Shear/Microburst Advisories, Paragraph 3-1-8b2(a).

FIG 7-1-18
Weak Microburst Alert

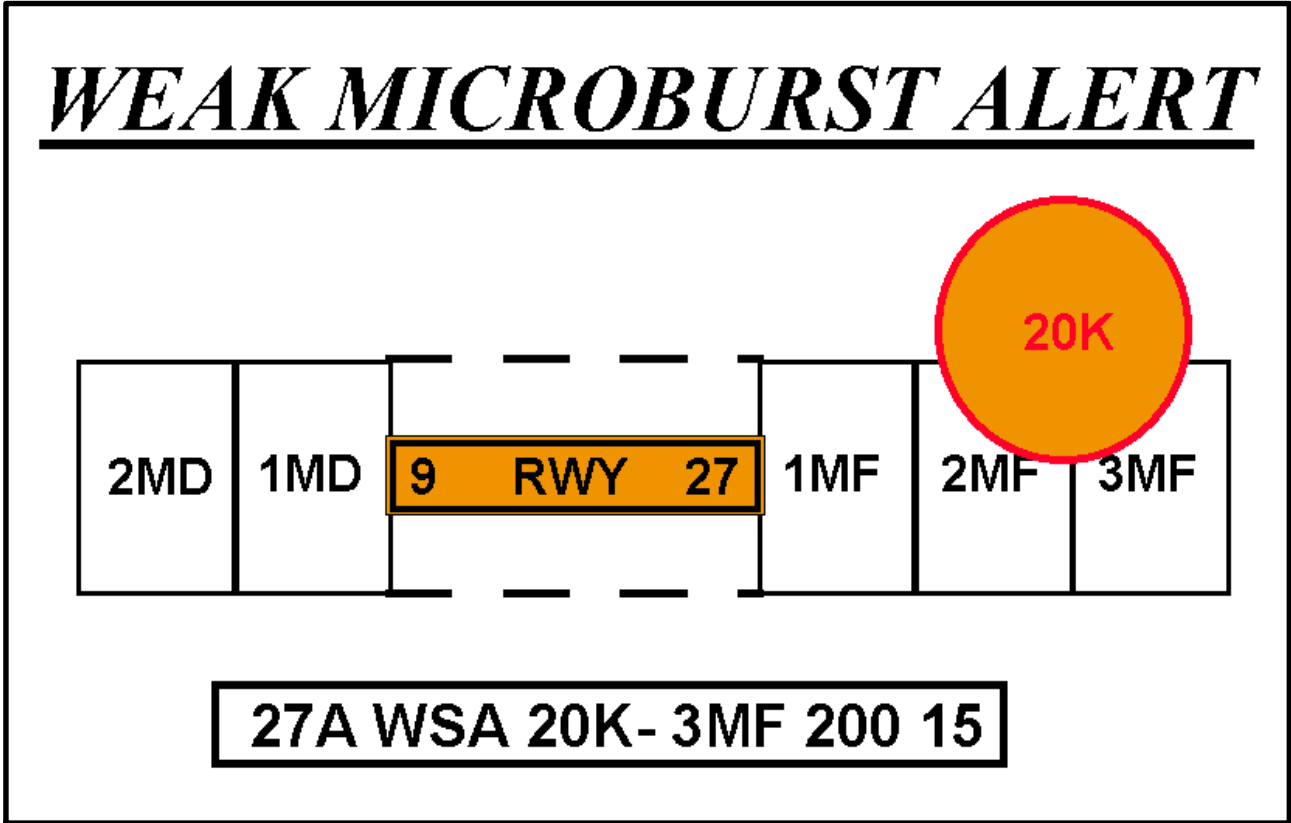
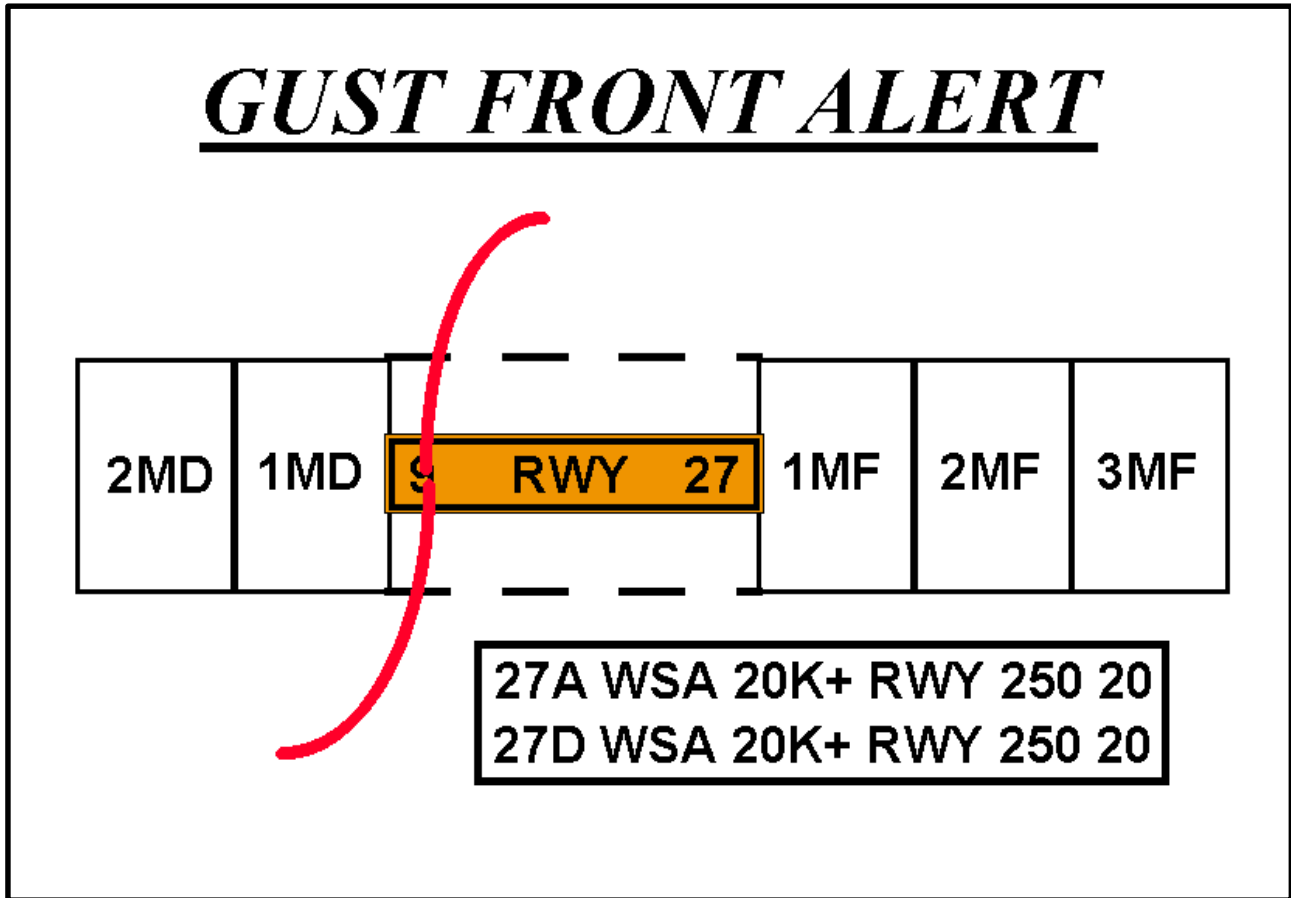

FIG 7-1-19
Gust Front Alert



(c) MULTIPLE WIND SHEAR ALERTS

EXAMPLE-

This is what the controller sees on his/her ribbon display in the tower cab.

27A WSA 20K+ RWY 250 20
27D WSA 20K+ RWY 250 20

NOTE-

(See FIG 7-1-19 to see how the TDWR/WSP determines the gust front/wind shear location.)

This is what the controller will say when issuing the alert.

PHRASEOLOGY-

MULTIPLE WIND SHEAR ALERTS. RUNWAY 27 ARRIVAL, WIND SHEAR ALERT, 20 KT GAIN ON RUNWAY; RUNWAY 27 DEPARTURE, WIND SHEAR ALERT, 20 KT GAIN ON RUNWAY, WIND 250 AT 20.

EXAMPLE-

In this example, the controller is advising arriving and departing aircraft that they could encounter a wind shear condition right on the runway due to a gust front (significant change of wind direction) with the possibility of a 20 knot gain in airspeed associated with the gust front. Additionally, the airport surface winds (for the runway in use) are reported as 250 degrees at 20 knots.

REFERENCE-

FAA Order 7110.65, Air Traffic Control, Low Level Wind Shear/Microburst Advisories, Paragraph 3-1-8b2(d).

6. The Terminal Weather Information for Pilots System (TWIP).

(a) With the increase in the quantity and quality of terminal weather information available through TDWR, the next step is to provide this information directly to pilots rather than relying on voice communications from ATC. The National Airspace System has long been in need of a means of delivering terminal weather information to the cockpit more efficiently in terms of both speed and accuracy to enhance pilot awareness of weather hazards and reduce air traffic controller workload. With the TWIP capability, terminal weather information, both alphanumerically and graphically, is now available directly to the cockpit at 43 airports in the U.S. NAS. (See FIG 7-1-20.)

FIG 7-1-20

TWIP Image of Convective Weather at MCO International

WEATHER SITUATION	TWIP TEXT MESSAGE
	<p>MCO 1800 TERMINAL WEATHER -STORM(S) 3NM N-E MOD PRECIP 4NM NE HVY PRECIP MOVG W AT 15KT .EXPECTED MOD PRECIP BEGIN 1805</p>
	<p>MCO 1810 TERMINAL WEATHER *MODERATE PRECIP BEGAN 1805 -STORM(S) ARPT ALQDS MOD PRECIP 1NM N-E HVY PRECIP MOVG W AT 15KT .EXPECTED HVY PRECIP BEGIN 1815</p>

(b) TWIP products are generated using weather data from the TDWR or the Integrated Terminal Weather System (ITWS) testbed. TWIP products are generated and stored in the form of text and character graphic messages. Software has been developed to allow TDWR or ITWS to format the data and send the TWIP products to a database resident at Aeronautical Radio, Inc. (ARINC). These products can then be accessed by pilots using the ARINC Aircraft Communications Addressing and Reporting System (ACARS) data link services. Airline dispatchers can also access this database and send messages to specific aircraft whenever wind shear activity begins or ends at an airport.

(c) TWIP products include descriptions and character graphics of microburst alerts, wind shear alerts, significant precipitation, convective activity

within 30 NM surrounding the terminal area, and expected weather that will impact airport operations. During inclement weather, i.e., whenever a predetermined level of precipitation or wind shear is detected within 15 miles of the terminal area, TWIP products are updated once each minute for text messages and once every five minutes for character graphic messages. During good weather (below the predetermined precipitation or wind shear parameters) each message is updated every 10 minutes. These products are intended to improve the situational awareness of the pilot/flight crew, and to aid in flight planning prior to arriving or departing the terminal area. It is important to understand that, in the context of TWIP, the predetermined levels for inclement versus good weather has nothing to do with the criteria for VFR/MVFR/IFR/LIFR; it only deals with precipitation, wind shears and microbursts.

TBL 7-1-11

TWIP-Equipped Airports

Airport	Identifier
Andrews AFB, MD	KADW
Hartsfield-Jackson Atlanta Intl Airport	KATL
Nashville Intl Airport	KBNA
Logan Intl Airport	KBOS
Baltimore/Washington Intl Airport	KBWI
Hopkins Intl Airport	KCLE
Charlotte/Douglas Intl Airport	KCLT
Port Columbus Intl Airport	KCMH
Cincinnati/Northern Kentucky Intl Airport	KCVG
Dallas Love Field Airport	KDAL
James M. Cox Intl Airport	KDAY
Ronald Reagan Washington National Airport	KDCA
Denver Intl Airport	KDEN
Dallas-Fort Worth Intl Airport	KDFW
Detroit Metro Wayne County Airport	KDTW
Newark Liberty Intl Airport	KEWR
Fort Lauderdale-Hollywood Intl Airport	KFLL
William P. Hobby Airport	KHOU
Washington Dulles Intl Airport	KIAD
George Bush Intercontinental Airport	KIAH
Wichita Mid-Continent Airport	KICT
Indianapolis Intl Airport	KIND

Airport	Identifier
John F. Kennedy Intl Airport	KJFK
LaGuardia Airport	KLGA
Kansas City Intl Airport	KMCI
Orlando Intl Airport	KMCO
Midway Intl Airport	KMDW
Memphis Intl Airport	KMEM
Miami Intl Airport	KMIA
General Mitchell Intl Airport	KMKE
Minneapolis St. Paul Intl Airport	KMSP
Louis Armstrong New Orleans Intl Airport	KMSY
Will Rogers World Airport	KOKC
O'Hare Intl Airport	KORD
Palm Beach Intl Airport	KPBI
Philadelphia Intl Airport	KPHL
Pittsburgh Intl Airport	KPIT
Raleigh-Durham Intl Airport	KRDU
Louisville Intl Airport	KSDF
Salt Lake City Intl Airport	KSLC
Lambert-St. Louis Intl Airport	KSTL
Tampa Intl Airport	KTPA
Tulsa Intl Airport	KTUL

7-1-27. PIREPs Relating to Volcanic Ash Activity

a. Volcanic eruptions which send ash into the upper atmosphere occur somewhere around the world several times each year. Flying into a volcanic ash cloud can be extremely dangerous. At least two B747s have lost all power in all four engines after such an encounter. Regardless of the type aircraft, some damage is almost certain to ensue after an encounter with a volcanic ash cloud. Additionally, studies have shown that volcanic eruptions are the only significant source of large quantities of sulphur dioxide (SO₂) gas at jet-cruising altitudes. Therefore, the detection and subsequent reporting of SO₂ is of significant importance. Although SO₂ is colorless, its presence in the atmosphere should be suspected when a sulphur-like or rotten egg odor is present throughout the cabin.

b. While some volcanoes in the U.S. are monitored, many in remote areas are not. These unmonitored volcanoes may erupt without prior warning to the aviation community. A pilot observing a volcanic eruption who has not had previous notification of it may be the only witness to the eruption. Pilots are strongly encouraged to transmit a PIREP regarding volcanic eruptions and any observed volcanic ash clouds or detection of sulphur dioxide (SO₂) gas associated with volcanic activity.

c. Pilots should submit PIREPs regarding volcanic activity using the Volcanic Activity Reporting (VAR) form as illustrated in Appendix 2. If a VAR form is not immediately available, relay enough information to identify the position and type of volcanic activity.

d. Pilots should verbally transmit the data required in items 1 through 8 of the VAR as soon as possible. The data required in items 9 through 16 of the VAR should be relayed after landing if possible.

7-1-28. Thunderstorms

a. Turbulence, hail, rain, snow, lightning, sustained updrafts and downdrafts, icing conditions—are present in thunderstorms. While there is some evidence that maximum turbulence exists at the middle level of a thunderstorm, recent studies show little variation of turbulence intensity with altitude.

b. There is no useful correlation between the external visual appearance of thunderstorms and the severity or amount of turbulence or hail within them. The visible thunderstorm cloud is only a portion of a turbulent system whose updrafts and downdrafts often extend far beyond the visible storm cloud. Severe turbulence can be expected up to 20 miles from severe thunderstorms. This distance decreases to about 10 miles in less severe storms.

c. Weather radar, airborne or ground based, will normally reflect the areas of moderate to heavy precipitation (radar does not detect turbulence). The frequency and severity of turbulence generally increases with the radar reflectivity which is closely associated with the areas of highest liquid water content of the storm. **NO FLIGHT PATH THROUGH AN AREA OF STRONG OR VERY STRONG RADAR ECHOES SEPARATED BY 20-30 MILES OR LESS MAY BE CONSIDERED FREE OF SEVERE TURBULENCE.**

d. Turbulence beneath a thunderstorm should not be minimized. This is especially true when the

relative humidity is low in any layer between the surface and 15,000 feet. Then the lower altitudes may be characterized by strong out flowing winds and severe turbulence.

e. The probability of lightning strikes occurring to aircraft is greatest when operating at altitudes where temperatures are between minus 5 degrees Celsius and plus 5 degrees Celsius. Lightning can strike aircraft flying in the clear in the vicinity of a thunderstorm.

f. METAR reports do not include a descriptor for severe thunderstorms. However, by understanding severe thunderstorm criteria, i.e., 50 knot winds or $\frac{3}{4}$ inch hail, the information is available in the report to know that one is occurring.

g. Current weather radar systems are able to objectively determine precipitation intensity. These precipitation intensity areas are described as “light,” “moderate,” “heavy,” and “extreme.”

REFERENCE–

Pilot/Controller Glossary– Precipitation Radar Weather Descriptions

EXAMPLE–

1. Alert provided by an ATC facility to an aircraft: (aircraft identification) **EXTREME** precipitation between ten o'clock and two o'clock, one five miles. Precipitation area is two five miles in diameter.

2. Alert provided by an FSS: (aircraft identification) **EXTREME** precipitation two zero miles west of Atlanta V–O–R, two five miles wide, moving east at two zero knots, tops flight level three niner zero.

7–1–29. Thunderstorm Flying

a. Thunderstorm Avoidance. Never regard any thunderstorm lightly, even when radar echoes are of light intensity. Avoiding thunderstorms is the best policy. Following are some Do's and Don'ts of thunderstorm avoidance:

1. Don't land or takeoff in the face of an approaching thunderstorm. A sudden gust front of low level turbulence could cause loss of control.

2. Don't attempt to fly under a thunderstorm even if you can see through to the other side. Turbulence and wind shear under the storm could be hazardous.

3. Don't attempt to fly under the anvil of a thunderstorm. There is a potential for severe and extreme clear air turbulence.

4. Don't fly without airborne radar into a cloud mass containing scattered embedded thunderstorms. Scattered thunderstorms not embedded usually can be visually circumnavigated.

5. Don't trust the visual appearance to be a reliable indicator of the turbulence inside a thunderstorm.

6. Don't assume that ATC will offer radar navigation guidance or deviations around thunderstorms.

7. Don't use data-linked weather next generation weather radar (NEXRAD) mosaic imagery as the sole means for negotiating a path through a thunderstorm area (tactical maneuvering).

8. Do remember that the data-linked NEXRAD mosaic imagery shows where the weather was, not where the weather is. The weather conditions may be 15 to 20 minutes older than the age indicated on the display.

9. Do listen to chatter on the ATC frequency for Pilot Weather Reports (PIREP) and other aircraft requesting to deviate or divert.

10. Do ask ATC for radar navigation guidance or to approve deviations around thunderstorms, if needed.

11. Do use data-linked weather NEXRAD mosaic imagery (for example, Flight Information Service-Broadcast (FIS-B)) for route selection to avoid thunderstorms entirely (strategic maneuvering).

12. Do advise ATC, when switched to another controller, that you are deviating for thunderstorms before accepting to rejoin the original route.

13. Do ensure that after an authorized weather deviation, before accepting to rejoin the original route, that the route of flight is clear of thunderstorms.

14. Do avoid by at least 20 miles any thunderstorm identified as severe or giving an intense radar echo. This is especially true under the anvil of a large cumulonimbus.

15. Do circumnavigate the entire area if the area has 6/10 thunderstorm coverage.

16. Do remember that vivid and frequent lightning indicates the probability of a severe thunderstorm.

17. Do regard as extremely hazardous any thunderstorm with tops 35,000 feet or higher whether the top is visually sighted or determined by radar.

18. Do give a PIREP for the flight conditions.

19. Do divert and wait out the thunderstorms on the ground if unable to navigate around an area of thunderstorms.

20. Do contact Flight Service for assistance in avoiding thunderstorms. Flight Service specialists have NEXRAD mosaic radar imagery and NEXRAD single site radar with unique features such as base and composite reflectivity, echo tops, and VAD wind profiles.

b. If you cannot avoid penetrating a thunderstorm, following are some Do's before entering the storm:

1. Tighten your safety belt, put on your shoulder harness (if installed), if and secure all loose objects.

2. Plan and hold the course to take the aircraft through the storm in a minimum time.

3. To avoid the most critical icing, establish a penetration altitude below the freezing level or above the level of -15°C.

4. Verify that pitot heat is on and turn on carburetor heat or jet engine anti-ice. Icing can be rapid at any altitude and cause almost instantaneous power failure and/or loss of airspeed indication.

5. Establish power settings for turbulence penetration airspeed recommended in the aircraft manual.

6. Turn up cockpit lights to highest intensity to lessen temporary blindness from lightning.

7. If using automatic pilot, disengage Altitude Hold Mode and Speed Hold Mode. The automatic altitude and speed controls will increase maneuvers of the aircraft thus increasing structural stress.

8. If using airborne radar, tilt the antenna up and down occasionally. This will permit the detection of other thunderstorm activity at altitudes other than the one being flown.

c. Following are some Do's and Don'ts during the thunderstorm penetration:

1. Do keep your eyes on your instruments. Looking outside the cockpit can increase danger of temporary blindness from lightning.

2. Don't change power settings; maintain settings for the recommended turbulence penetration airspeed.

3. Do maintain constant attitude. Allow the altitude and airspeed to fluctuate.

4. Don't turn back once you are in the thunderstorm. A straight course through the storm most likely will get the aircraft out of the hazards most quickly. In addition, turning maneuvers increase stress on the aircraft.

7-1-30. Key to Aerodrome Forecast (TAF) and Aviation Routine Weather Report (METAR)

FIG 7-1-21

Key to Aerodrome Forecast (TAF) and Aviation Routine Weather Report (METAR) (Front)



Key to Aerodrome Forecast (TAF) and Aviation Routine Weather Report (METAR) (Front)



TAF	KPIT 091730Z 0918/1024 15005KT 5SM HZ FEW020 WS010/31022KT FM091930 30015G25KT 3SM SHRA OVC015 TEMPO 0920/0922 1/2SM +TSRA OVC008CB FM100100 27008KT 5SM SHRA BKN020 OVC040 PROB30 1004/1007 1SM -RA BR FM101015 18005KT 6SM -SHRA OVC020 BECMG 1013/1015 P6SM NSW SKC
NOTE: Users are cautioned to confirm <i>DATE</i> and <i>TIME</i> of the TAF. For example FM100000 is 0000Z on the 10th . Do not confuse with 1000Z!	
METAR	KPIT 091955Z COR 22015G25KT 3/4SM R28L/2600FT TSRA OVC010CB 18/16 A2992 RMK SLP045 T01820159

Forecast	Explanation	Report
TAF	Message type: <u>TAF</u> -routine or <u>TAF AMD</u> -amended forecast, <u>METAR</u> -hourly, <u>SPECI</u> -special or <u>TESTM</u> -non-commissioned ASOS report	METAR
KPIT	ICAO location indicator	KPIT
091730Z	Issuance time: ALL times in UTC “Z”, 2-digit date, 4-digit time	091955Z
0918/1024	Valid period, either 24 hours or 30 hours. The first two digits of EACH four digit number indicate the date of the valid period, the final two digits indicate the time (valid from 18Z on the 9 th to 24Z on the 10 th). In U.S. METAR: <u>COR</u> rected ob; or <u>AUTOM</u> ated ob for automated report with no human intervention; omitted when observer logs on.	COR
15005KT	Wind: 3 digit true-north direction, nearest 10 degrees (or <u>VaRiAbLe</u>); next 2-3 digits for speed and unit, <u>KT</u> (KMH or MPS); as needed, <u>G</u> ust and maximum speed; 00000KT for calm; for METAR, if direction varies 60 degrees or more, <u>Variability</u> appended, e.g., 180 <u>V</u> 260	22015G25KT
5SM	Prevailing visibility; in U.S., Statute <u>M</u> iles & fractions; above 6 miles in TAF <u>Plus6SM</u> . (Or, 4-digit minimum visibility in meters and as required, lowest value with direction)	3/4SM
	Runway Visual Range: <u>R</u> ; 2-digit runway designator <u>L</u> eft, <u>C</u> enter, or <u>R</u> ight as needed; “ <u>L</u> ”, Minus or Plus in U.S., 4-digit value, <u>F</u> eeT in U.S., (usually meters elsewhere); 4-digit value <u>V</u> ariability 4-digit value (and tendency <u>D</u> own, <u>U</u> p or <u>N</u> o change)	R28L/2600FT
HZ	Significant present, forecast and recent weather: see table (on back)	TSRA
FEW020	Cloud amount, height and type: <u>S</u> ky <u>C</u> lear 0/8, <u>F</u> EW >0/8-2/8, <u>S</u> caTtered 3/8-4/8, <u>B</u> roKeN 5/8-7/8, <u>O</u> verCasted 8/8; 3-digit height in hundreds of ft; <u>T</u> owering <u>C</u> umulus or <u>C</u> umuloni <u>M</u> Bus in <u>METAR</u> ; in <u>TAF</u> , only <u>CB</u> . <u>V</u> ertical <u>V</u> isibility for obscured sky and height “VV004”. More than 1 layer may be reported or forecast. In automated <u>METAR</u> reports only, <u>C</u> lea <u>R</u> for “clear below 12,000 feet”	OVC 010CB
	Temperature: degrees Celsius; first 2 digits, temperature “ <u>L</u> ” last 2 digits, dew-point temperature; <u>M</u> inus for below zero, e.g., M06	18/16
	Altimeter setting: indicator and 4 digits; in U.S., <u>A</u> -inches and hundredths; (<u>Q</u> -hectoPascals, e.g., Q1013)	A2992
WS010/31022KT	In U.S. <u>TAF</u> , non-convective low-level (<u>2,000 ft) <u>W</u> ind <u>S</u> hear; 3-digit height (hundreds of ft); “ <u>L</u> ”; 3-digit wind direction and 2-3 digit wind speed above the indicated height, and unit, <u>KT</u>	

FIG 7-1-22

Key to Aerodrome Forecast (TAF) and Aviation Routine Weather Report (METAR) (Back)



Key to Aerodrome Forecast (TAF) and Aviation Routine Weather Report (METAR) (Back)



	In METAR , ReMarK indicator & remarks. For example: <u>Sea- Level</u> Pressure in hectoPascals & tenths, as shown: 1004.5 hPa; <u>Temp/dew-point</u> in tenths °C, as shown: temp. 18.2°C, dew-point 15.9°C	RMK SLP045 T01820159
FM091930	FroM : changes are expected at: 2-digit date, 2-digit hour, and 2-digit minute beginning time: indicates significant change. Each FM starts on a new line, indented 5 spaces	
TEMPO 0920/0922	TEMPO rary: changes expected for <1 hour and in total, < half of the period between the 2-digit date and 2-digit hour beginning, and 2-digit date and 2-digit hour ending time	
PROB30 1004/1007	PROB ability and 2-digit percent (30 or 40): probable condition in the period between the 2-digit date & 2-digit hour beginning time, and the 2-digit date and 2-digit hour ending time	
BECMG 1013/1015	BECO MinG: change expected in the period between the 2-digit date and 2-digit hour beginning time, and the 2-digit date and 2-digit hour ending time	

Table of Significant Present, Forecast and Recent Weather - Grouped in categories and used in the order listed below; or as needed in TAF, <u>No Significant Weather</u>.			
Qualifiers			
Intensity or Proximity			
“-” = Light		No sign = Moderate	“+” = Heavy
“VC” = Vicinity, but not at aerodrome. In the US METAR, 5 to 10 SM from the point of observation. In the US TAF, 5 to 10 SM from the center of the runway complex. Elsewhere, within 8000m.			
Descriptor			
BC – Patches	BL – Blowing	DR – Drifting	FZ – Freezing
MI – Shallow	PR – Partial	SH – Showers	TS – Thunderstorm
Weather Phenomena			
Precipitation			
DZ – Drizzle	GR – Hail	GS – Small Hail/Snow Pellets	
IC – Ice Crystals	PL – Ice Pellets	RA – Rain	SG – Snow Grains
SN – Snow	UP – Unknown Precipitation in automated observations		
Obscuration			
BR – Mist (≥5/8SM)	DU – Widespread Dust	FG – Fog (<5/8SM)	FU – Smoke
HZ – Haze	PY – Spray	SA – Sand	VA – Volcanic Ash
Other			
DS – Dust Storm	FC – Funnel Cloud	+FC – Tornado or Waterspout	
PO – Well developed dust or sand whirls		SQ – Squall	SS – Sandstorm
<ul style="list-style-type: none"> - Explanations in parentheses “()” indicate different worldwide practices. - Ceiling is not specified; defined as the lowest broken or overcast layer, or the vertical visibility. - NWS TAFs exclude BECMG groups and temperature forecasts, NWS TAFS do not use PROB in the first 9 hours of a TAF; NWS METARs exclude trend forecasts. US Military TAFs include Turbulence and Icing groups. 			

7-1-31. International Civil Aviation Organization (ICAO) Weather Formats

The U.S. uses the ICAO world standard for aviation weather reporting and forecasting. The World Meteorological Organization's (WMO) publication No. 782 "Aerodrome Reports and Forecasts" contains the base METAR and TAF code as adopted by the WMO member countries.

a. Although the METAR code is adopted worldwide, each country is allowed to make modifications or exceptions to the code for use in their particular country, e.g., the U.S. will continue to use statute miles for visibility, feet for RVR values, knots for wind speed, and inches of mercury for altimetry. However, temperature and dew point will be reported in degrees Celsius. The U.S. reports prevailing visibility rather than lowest sector visibility. The elements in the body of a METAR report are separated with a space. The only exceptions are RVR, temperature, and dew point which are separated with a solidus (/). When an element does not occur, or cannot be observed, the preceding space and that element are omitted from that particular report. A METAR report contains the following sequence of elements in the following order:

1. Type of report.
2. ICAO Station Identifier.
3. Date and time of report.
4. Modifier (as required).
5. Wind.
6. Visibility.
7. Runway Visual Range (RVR).
8. Weather phenomena.
9. Sky conditions.
10. Temperature/dew point group.
11. Altimeter.
12. Remarks (RMK).

b. The following paragraphs describe the elements in a METAR report.

1. **Type of report.** There are two types of report:

(a) Aviation Routine Weather Report (METAR); and

(b) Nonroutine (Special) Aviation Weather Report (SPECI).

The type of report (METAR or SPECI) will always appear as the lead element of the report.

2. **ICAO Station Identifier.** The METAR code uses ICAO 4-letter station identifiers. In the contiguous 48 States, the 3-letter domestic station identifier is prefixed with a "K;" i.e., the domestic identifier for Seattle is SEA while the ICAO identifier is KSEA. Elsewhere, the first two letters of the ICAO identifier indicate what region of the world and country (or state) the station is in. For Alaska, all station identifiers start with "PA;" for Hawaii, all station identifiers start with "PH." Canadian station identifiers start with "CU," "CW," "CY," and "CZ." Mexican station identifiers start with "MM." The identifier for the western Caribbean is "M" followed by the individual country's letter; i.e., Cuba is "MU;" Dominican Republic "MD;" the Bahamas "MY." The identifier for the eastern Caribbean is "T" followed by the individual country's letter; i.e., Puerto Rico is "TJ." For a complete worldwide listing see ICAO Document 7910, Location Indicators.

3. **Date and Time of Report.** The date and time the observation is taken are transmitted as a six-digit date/time group appended with Z to denote Coordinated Universal Time (UTC). The first two digits are the date followed with two digits for hour and two digits for minutes.

EXAMPLE-

172345Z (the 17th day of the month at 2345Z)

4. **Modifier (As Required).** "AUTO" identifies a METAR/SPECI report as an automated weather report with no human intervention. If "AUTO" is shown in the body of the report, the type of sensor equipment used at the station will be encoded in the remarks section of the report. The absence of "AUTO" indicates that a report was made manually by an observer or that an automated report had human augmentation/backup. The modifier "COR" indicates a corrected report that is sent out to replace an earlier report with an error.

NOTE-

There are two types of automated stations, AO1 for automated weather reporting stations without a precipitation discriminator, and AO2 for automated stations with a precipitation discriminator. (A precipitation discriminator can determine the difference between liquid and frozen/freezing precipitation). This information appears in the remarks section of an automated report.

5. Wind. The wind is reported as a five digit group (six digits if speed is over 99 knots). The first three digits are the direction the wind is blowing from, in tens of degrees referenced to true north, or “VRB” if the direction is variable. The next two digits is the wind speed in knots, or if over 99 knots, the next three digits. If the wind is gusty, it is reported as a “G” after the speed followed by the highest gust reported. The abbreviation “KT” is appended to denote the use of knots for wind speed.

EXAMPLE–

13008KT – wind from 130 degrees at 8 knots

08032G45KT – wind from 080 degrees at 32 knots with gusts to 45 knots

VRB04KT – wind variable in direction at 4 knots

00000KT – wind calm

210103G130KT – wind from 210 degrees at 103 knots with gusts to 130 knots

If the wind direction is variable by 60 degrees or more and the speed is greater than 6 knots, a variable group consisting of the extremes of the wind direction separated by a “v” will follow the prevailing wind group.

32012G22KT 280V350

(a) Peak Wind. Whenever the peak wind exceeds 25 knots “PK WND” will be included in Remarks, e.g., PK WND 28045/1955 “Peak wind two eight zero at four five occurred at one niner five five.” If the hour can be inferred from the report time, only the minutes will be appended, e.g., PK WND 34050/38 “Peak wind three four zero at five zero occurred at three eight past the hour.”

(b) Wind shift. Whenever a wind shift occurs, “WSHFT” will be included in remarks followed by the time the wind shift began, e.g., WSHFT 30 FROPA “Wind shift at three zero due to frontal passage.”

6. Visibility. Prevailing visibility is reported in statute miles with “SM” appended to it.

EXAMPLE–

7SM – seven statute miles

15SM – fifteen statute miles

1/2SM – one-half statute mile

(a) Tower/surface visibility. If either visibility (tower or surface) is below four statute miles,

the lesser of the two will be reported in the body of the report; the greater will be reported in remarks.

(b) Automated visibility. ASOS/AWOS visibility stations will show visibility 10 or greater than 10 miles as “10SM.” AWOS visibility stations will show visibility less than 1/4 statute mile as “M^{1/4}SM” and visibility 10 or greater than 10 miles as “10SM.”

NOTE–

Automated sites that are augmented by human observer to meet service level requirements can report 0, 1/16 SM, and 1/8 SM visibility increments.

(c) Variable visibility. Variable visibility is shown in remarks (when rapid increase or decrease by 1/2 statute mile or more and the average prevailing visibility is less than three miles) e.g., VIS 1V2 “visibility variable between one and two.”

(d) Sector visibility. Sector visibility is shown in remarks when it differs from the prevailing visibility, and either the prevailing or sector visibility is less than three miles.

EXAMPLE–

VIS N2 – visibility north two

7. Runway Visual Range (When Reported). “R” identifies the group followed by the runway heading (and parallel runway designator, if needed) “/” and the visual range in feet (meters in other countries) followed with “FT” (feet is not spoken).

(a) Variability Values. When RVR varies (by more than on reportable value), the lowest and highest values are shown with “V” between them.

(b) Maximum/Minimum Range. “P” indicates an observed RVR is above the maximum value for this system (spoken as “more than”). “M” indicates an observed RVR is below the minimum value which can be determined by the system (spoken as “less than”).

EXAMPLE–

R32L/1200FT – runway three two left R–V–R one thousand two hundred.

R27R/M1000V4000FT – runway two seven right R–V–R variable from less than one thousand to four thousand.

8. Weather Phenomena. The weather as reported in the METAR code represents a significant change in the way weather is currently reported. In METAR, weather is reported in the format:

Intensity/Proximity/Descriptor/Precipitation/Obstruction to visibility/Other

NOTE-

The “/” above and in the following descriptions (except as the separator between the temperature and dew point) are for separation purposes in this publication and do not appear in the actual METARs.

(a) **Intensity** applies only to the first type of precipitation reported. A “-” denotes light, no symbol denotes moderate, and a “+” denotes heavy.

(b) **Proximity** applies to and reported only for weather occurring in the vicinity of the airport (between 5 and 10 miles of the point(s) of observation). It is denoted by the letters “VC.” (Intensity and “VC” will not appear together in the weather group).

(c) **Descriptor.** These eight descriptors apply to the precipitation or obstructions to visibility:

- TS thunderstorm
- DR low drifting
- SH showers
- MI shallow
- FZ freezing
- BC patches
- BL blowing
- PR partial

NOTE-

Although “TS” and “SH” are used with precipitation and may be preceded with an intensity symbol, the intensity still applies to the precipitation, **not** the descriptor.

(d) **Precipitation.** There are nine types of precipitation in the METAR code:

- RA rain
- DZ drizzle
- SN snow
- GR hail (1/4” or greater)
- GS small hail/snow pellets
- PL ice pellets
- SG snow grains
- IC ice crystals (diamond dust)
- UP unknown precipitation
(automated stations only)

(e) **Obstructions to visibility.** There are eight types of obscuration phenomena in the METAR code (obscurations are any phenomena in the atmosphere, other than precipitation, that reduce horizontal visibility):

- FG fog (vsby less than 5/8 mile)
- HZ haze
- FU smoke
- PY spray
- BR mist (vsby 5/8 – 6 miles)
- SA sand
- DU dust
- VA volcanic ash

NOTE-

Fog (FG) is observed or forecast only when the visibility is less than five-eighths of mile, otherwise mist (BR) is observed or forecast.

(f) **Other.** There are five categories of other weather phenomena which are reported when they occur:

- SQ squall
- SS sandstorm
- DS duststorm
- PO dust/sand whirls
- FC funnel cloud
- +FC tornado/waterspout

Examples:

- TSRA thunderstorm with moderate rain
- +SN heavy snow
- RA FG light rain and fog
- BRHZ mist and haze
(visibility 5/8 mile or greater)
- FZDZ freezing drizzle
- VCSH rain shower in the vicinity
- +SHRASNPL .. heavy rain showers, snow, ice pellets (intensity indicator refers to the predominant rain)

9. Sky Condition. The sky condition as reported in METAR represents a significant change from the way sky condition is currently reported. In METAR, sky condition is reported in the format:

Amount/Height/(Type) or Indefinite Ceiling/Height

(a) **Amount.** The amount of sky cover is reported in eighths of sky cover, using the contractions:

- SKC clear (no clouds)
- FEW >0 to 2/8
- SCT scattered (3/8s to 4/8s of clouds)
- BKN broken (5/8s to 7/8s of clouds)
- OVC overcast (8/8s clouds)
- CB Cumulonimbus when present
- TCU Towering cumulus when present

NOTE-

1. "SKC" will be reported at manual stations. "CLR" will be used at automated stations when no clouds below 12,000 feet are reported.

2. A ceiling layer is not designated in the METAR code. For aviation purposes, the ceiling is the lowest broken or overcast layer, or vertical visibility into an obscuration. Also there is no provision for reporting thin layers in the METAR code. When clouds are thin, that layer must be reported as if it were opaque.

(b) **Height.** Cloud bases are reported with three digits in hundreds of feet above ground level (AGL). (Clouds above 12,000 feet cannot be reported by an automated station).

(c) **(Type).** If Towering Cumulus Clouds (TCU) or Cumulonimbus Clouds (CB) are present, they are reported after the height which represents their base.

EXAMPLE-

(Reported as) SCT025TCU BKN080 BKN250 (spoken as) "TWO THOUSAND FIVE HUNDRED SCATTERED TOWERING CUMULUS, CEILING EIGHT THOUSAND BROKEN, TWO FIVE THOUSAND BROKEN."
 (Reported as) SCT008 OVC012CB (spoken as) "EIGHT HUNDRED SCATTERED CEILING ONE THOUSAND TWO HUNDRED OVERCAST CUMULONIMBUS CLOUDS."

(d) **Vertical Visibility (indefinite ceiling height).** The height into an indefinite ceiling is preceded by "VV" and followed by three digits indicating the vertical visibility in hundreds of feet. This layer indicates total obscuration.

EXAMPLE-

1/8 SM FG VV006 – visibility one eighth, fog, indefinite ceiling six hundred.

(e) **Obscurations** are reported when the sky is partially obscured by a ground-based phenomena by indicating the amount of obscuration as FEW, SCT, BKN followed by three zeros (000). In remarks, the obscuring phenomenon precedes the amount of obscuration and three zeros.

EXAMPLE-

BKN000 (in body) "sky partially obscured"
 FU BKN000 (in remarks) "smoke obscuring five-to seven-eighths of the sky"

(f) When sky conditions include a layer aloft, other than clouds, such as smoke or haze the type of phenomena, sky cover and height are shown in remarks.

EXAMPLE-

BKN020 (in body) "ceiling two thousand broken"
 RMK FU BKN020 "broken layer of smoke aloft, based at two thousand"

(g) **Variable ceiling.** When a ceiling is below three thousand and is variable, the remark "CIG" will be shown followed with the lowest and highest ceiling heights separated by a "V."

EXAMPLE-

CIG 005V010 "ceiling variable between five hundred and one thousand"

(h) **Second site sensor.** When an automated station uses meteorological discontinuity sensors, remarks will be shown to identify site specific sky conditions which differ and are lower than conditions reported in the body.

EXAMPLE-

CIG 020 RY11 "ceiling two thousand at runway one one"

(i) **Variable cloud layer.** When a layer is varying in sky cover, remarks will show the variability range. If there is more than one cloud layer, the variable layer will be identified by including the layer height.

EXAMPLE-

SCT V BKN "scattered layer variable to broken"
 BKN025 V OVC "broken layer at two thousand five hundred variable to overcast"

(j) Significant clouds. When significant clouds are observed, they are shown in remarks, along with the specified information as shown below:

(1) Cumulonimbus (CB), or Cumulonimbus Mammatus (CBMAM), distance (if known), direction from the station, and direction of movement, if known. If the clouds are beyond 10 miles from the airport, DSNT will indicate distance.

EXAMPLE-

CB W MOVE “cumulonimbus west moving east”
CBMAM DSNT S “cumulonimbus mammatus distant south”

(2) Towering Cumulus (TCU), location, (if known), or direction from the station.

EXAMPLE-

TCU OHD “towering cumulus overhead”
TCU W “towering cumulus west”

(3) Altocumulus Castellanus (ACC), Stratocumulus Standing Lenticular (SCSL), Altocumulus Standing Lenticular (ACSL), Cirrocumulus Standing Lenticular (CCSL) or rotor clouds, describing the clouds (if needed) and the direction from the station.

EXAMPLE-

ACC W “altocumulus castellanus west”
ACSL SW-S “standing lenticular altocumulus southwest through south”
APRNT ROTOR CLD S “apparent rotor cloud south”
CCSL OVR MTE “standing lenticular cirrocumulus over the mountains east”

10. Temperature/Dew Point. Temperature and dew point are reported in two, two-digit groups in degrees Celsius, separated by a solidus (“/”). Temperatures below zero are prefixed with an “M.” If the temperature is available but the dew point is missing, the temperature is shown followed by a solidus. If the temperature is missing, the group is omitted from the report.

EXAMPLE-

15/08 “temperature one five, dew point 8”
00/M02 “temperature zero, dew point minus 2”

M05/ “temperature minus five, dew point missing”

11. Altimeter. Altimeter settings are reported in a four-digit format in inches of mercury prefixed with an “A” to denote the units of pressure.

EXAMPLE-

A2995 – “Altimeter two niner niner five”

12. Remarks. Remarks will be included in all observations, when appropriate. The contraction “RMK” denotes the start of the remarks section of a METAR report.

Except for precipitation, phenomena located within 5 statute miles of the point of observation will be reported as at the station. Phenomena between 5 and 10 statute miles will be reported in the vicinity, “VC.” Precipitation not occurring at the point of observation but within 10 statute miles is also reported as in the vicinity, “VC.” Phenomena beyond 10 statute miles will be shown as distant, “DSNT.” Distances are in statute miles except for automated lightning remarks which are in nautical miles. Movement of clouds or weather will be indicated by the direction toward which the phenomena is moving.

(a) There are two categories of remarks:

- (1)** Automated, manual, and plain language.
- (2)** Additive and automated maintenance data.

(b) Automated, Manual, and Plain Language. This group of remarks may be generated from either manual or automated weather reporting stations and generally elaborate on parameters reported in the body of the report. (Plain language remarks are only provided by manual stations).

- (1)** Volcanic eruptions.
- (2)** Tornado, Funnel Cloud, Waterspout.
- (3)** Station Type (AO1 or AO2).
- (4)** PK WND.
- (5)** WSHFT (FROPA).
- (6)** TWR VIS or SFC VIS.
- (7)** VRB VIS.
- (8)** Sector VIS.
- (9)** VIS @ 2nd Site.

(10) **Lightning.** When lightning is observed at a manual location, the frequency and location is reported.

When cloud-to-ground lightning is detected by an automated lightning detection system, such as ALDARS:

[a] Within 5 nautical miles (NM) of the Airport Reference Point (ARP), it will be reported as “TS” in the body of the report with no remark;

[b] Between 5 and 10 NM of the ARP, it will be reported as “VCTS” in the body of the report with no remark;

[c] Beyond 10 but less than 30 NM of the ARP, it will be reported in remarks as “DSNT” followed by the direction from the ARP.

EXAMPLE-

LTG DSNT W or LTG DSNT ALQDS

- (11) Beginning/Ending of Precipitation/TSTMS.
- (12) TSTM Location MVMT.
- (13) Hailstone Size (GR).
- (14) Virga.
- (15) VRB CIG (height).
- (16) Obscuration.
- (17) VRB Sky Condition.
- (18) Significant Cloud Types.
- (19) Ceiling Height 2nd Location.
- (20) PRESFR PRESRR.
- (21) Sea-Level Pressure.
- (22) ACFT Mishap (not transmitted).
- (23) NOSPECI.
- (24) SNINCR.
- (25) Other SIG Info.

(c) Additive and Automated Maintenance Data.

- (1) Hourly Precipitation.
- (2) 3- and 6-Hour Precipitation Amount.
- (3) 24-Hour Precipitation.
- (4) Snow Depth on Ground.

- (5) Water Equivalent of Snow.
- (6) Cloud Type.
- (7) Duration of Sunshine.
- (8) Hourly Temperature/Dew Point (Tenths).
- (9) 6-Hour Maximum Temperature.
- (10) 6-Hour Minimum Temperature.
- (11) 24-Hour Maximum/Minimum Temperature.
- (12) Pressure Tendency.
- (13) Sensor Status.
PWINO
FZRANO
TSNO
RVRNO
PNO
VISNO

Examples of METAR reports and explanation:

METAR KBNA 281250Z 33018KT 290V360 1/2SM R31/2700FT SN BLSN FG VV008 00/M03 A2991 RMK RAE42SNB42

METAR aviation routine weather report
KBNA Nashville, TN
281250Z date 28th, time 1250 UTC
(no modifier) . . This is a manually generated report, due to the absence of “AUTO” and “AO1 or AO2” in remarks
33018KT wind three three zero at one eight
290V360 wind variable between two nine zero and three six zero
1/2SM visibility one half
R31/2700FT . . . Runway three one RVR two thousand seven hundred
SN moderate snow
BLSN FG visibility obscured by blowing snow and fog
VV008 indefinite ceiling eight hundred
00/M03 temperature zero, dew point minus three
A2991 altimeter two niner niner one
RMK remarks

RAE42 rain ended at four two
SNB42 snow began at four two

TS W MOV E thunderstorm west moving east

METAR KSFO 041453Z AUTO VRB02KT 3SM
 BR CLR 15/12 A3012 RMK AO2

METAR aviation routine weather report
KSFO San Francisco, CA
041453Z date 4th, time 1453 UTC
AUTO fully automated; no human intervention
VRB02KT wind variable at two
3SM visibility three
BR visibility obscured by mist
CLR no clouds below one two thousand
15/12 temperature one five, dew point one two
A3012 altimeter three zero one two
RMK remarks
AO2 this automated station has a weather discriminator (for precipitation)

SPECI KCVG 152224Z 28024G36KT 3/4SM
 +TSRA BKN008 OVC020CB 28/23 A3000 RMK
 TSRAB24 TS W MOV E

SPECI (nonroutine) aviation special weather report
KCVG Cincinnati, OH
152228Z date 15th, time 2228 UTC
(no modifier) . . This is a manually generated report due to the absence of “AUTO” and “AO1 or AO2” in remarks
28024G36KT wind two eight zero at two four gusts three six
3/4SM visibility three fourths
+TSRA thunderstorms, heavy rain
BKN008 ceiling eight hundred broken
OVC020CB two thousand overcast cumulonimbus clouds
28/23 temperature two eight, dew point two three
A3000 altimeter three zero zero zero
RMK remarks
TSRAB24 thunderstorm and rain began at two four

c. Aerodrome Forecast (TAF). A concise statement of the expected meteorological conditions at an airport during a specified period. At most locations, TAFs have a 24 hour forecast period. However, TAFs for some locations have a 30 hour forecast period. These forecast periods may be shorter in the case of an amended TAF. TAFs use the same codes as METAR weather reports. They are scheduled four times daily for 24-hour periods beginning at 0000Z, 0600Z, 1200Z, and 1800Z.

Forecast times in the TAF are depicted in two ways. The first is a 6-digit number to indicate a specific point in time, consisting of a two-digit date, two-digit hour, and two-digit minute (such as issuance time or FM). The second is a pair of four-digit numbers separated by a “/” to indicate a beginning and end for a period of time. In this case, each four-digit pair consists of a two-digit date and a two-digit hour.

TAFs are issued in the following format:

TYPE OF REPORT/ICAO STATION IDENTIFIER/
 DATE AND TIME OF ORIGIN/VALID PERIOD
 DATE AND TIME/FORECAST METEOROLOGICAL
 CONDITIONS

NOTE-

The “/” above and in the following descriptions are for separation purposes in this publication and do not appear in the actual TAFs.

TAF KORD 051130Z 0512/0618 14008KT 5SM BR
 BKN030
 TEMPO 0513/0516 1 1/2SM BR
 FM051600 16010KT P6SM SKC
 FM052300 20013G20KT 4SM SHRA OVC020
 PROB40 0600/0606 2SM TSRA OVC008CB
 BECMG 0606/0608 21015KT P6SM NSW
 SCT040

TAF format observed in the above example:

TAF = type of report

KORD = ICAO station identifier

051130Z = date and time of origin (issuance time)

0512/0618 = valid period date and times

14008KT 5SM BR BKN030 = forecast meteorological conditions

Explanation of TAF elements:

1. Type of Report. There are two types of TAF issuances, a routine forecast issuance (TAF) and an amended forecast (TAF AMD). An amended TAF is issued when the current TAF no longer adequately describes the on-going weather or the forecaster feels the TAF is not representative of the current or expected weather. Corrected (COR) or delayed (RTD) TAFs are identified only in the communications header which precedes the actual forecasts.

2. ICAO Station Identifier. The TAF code uses ICAO 4-letter location identifiers as described in the METAR section.

3. Date and Time of Origin. This element is the date and time the forecast is actually prepared. The format is a two-digit date and four-digit time followed, without a space, by the letter “Z.”

4. Valid Period Date and Time. The UTC valid period of the forecast consists of two four-digit sets, separated by a “/”. The first four-digit set is a two-digit date followed by the two-digit beginning hour, and the second four-digit set is a two-digit date followed by the two-digit ending hour. Although most airports have a 24-hour TAF, a select number of airports have a 30-hour TAF. In the case of an amended forecast, or a forecast which is corrected or delayed, the valid period may be for less than 24 hours. Where an airport or terminal operates on a part-time basis (less than 24 hours/day), the TAFs issued for those locations will have the abbreviated statement “AMD NOT SKED” added to the end of the forecasts. The time observations are scheduled to end and/or resume will be indicated by expanding the AMD NOT SKED statement. Expanded statements will include:

(a) Observation ending time (AFT DDHHmm; for example, AFT 120200)

(b) Scheduled observations resumption time (TIL DDHHmm; for example, TIL 171200Z) or

(c) Period of observation unavailability (DDHH/DDHH); for example, 2502/2512).

5. Forecast Meteorological Conditions. This is the body of the TAF. The basic format is:

WIND/VISIBILITY/WEATHER/SKY CONDITION/OPTIONAL DATA (WIND SHEAR)

The wind, visibility, and sky condition elements are always included in the initial time group of the forecast. Weather is included only if significant to

aviation. If a significant, lasting change in any of the elements is expected during the valid period, a new time period with the changes is included. It should be noted that with the exception of a “FM” group the new time period will include only those elements which are expected to change, i.e., if a lowering of the visibility is expected but the wind is expected to remain the same, the new time period reflecting the lower visibility would not include a forecast wind. The forecast wind would remain the same as in the previous time period. Any temporary conditions expected during a specific time period are included with that time period. The following describes the elements in the above format.

(a) **Wind.** This five (or six) digit group includes the expected wind direction (first 3 digits) and speed (last 2 digits or 3 digits if 100 knots or greater). The contraction “KT” follows to denote the units of wind speed. Wind gusts are noted by the letter “G” appended to the wind speed followed by the highest expected gust. A variable wind direction is noted by “VRB” where the three digit direction usually appears. A calm wind (3 knots or less) is forecast as “0000KT.”

EXAMPLE–

18010KT wind one eight zero at one zero (wind is blowing from 180).

35012G20KT wind three five zero at one two gust two zero.

(b) **Visibility.** The expected prevailing visibility up to and including 6 miles is forecast in statute miles, including fractions of miles, followed by “SM” to note the units of measure. Expected visibilities greater than 6 miles are forecast as P6SM (plus six statute miles).

EXAMPLE–

$\frac{1}{2}$ SM – visibility one-half

4SM – visibility four

P6SM – visibility more than six

(c) **Weather Phenomena.** The expected weather phenomena is coded in TAF reports using the same format, qualifiers, and phenomena contractions as METAR reports (except UP). Obscurations to vision will be forecast whenever the prevailing visibility is forecast to be 6 statute miles or less. If no significant weather is expected to occur during a specific time period in the forecast, the weather phenomena group is omitted for that time period. If, after a time period in which significant weather phenomena has been forecast, a change to a forecast

of no significant weather phenomena occurs, the contraction NSW (No Significant Weather) will appear as the weather group in the new time period. (NSW is included only in TEMPO groups).

NOTE-

It is very important that pilots understand that NSW only refers to weather phenomena, i.e., rain, snow, drizzle, etc. Omitted conditions, such as sky conditions, visibility, winds, etc., are carried over from the previous time group.

(d) Sky Condition. TAF sky condition forecasts use the METAR format described in the METAR section. Cumulonimbus clouds (CB) are the only cloud type forecast in TAFs. When clear skies are forecast, the contraction “SKC” will always be used. The contraction “CLR” is never used in the TAF. When the sky is obscured due to a surface-based phenomenon, vertical visibility (VV) into the obscuration is forecast. The format for vertical visibility is “VV” followed by a three-digit height in hundreds of feet.

NOTE-

As in METAR, ceiling layers are not designated in the TAF code. For aviation purposes, the ceiling is the lowest broken or overcast layer or vertical visibility into a complete obscuration.

- SKC “sky clear”
- SCT005 BKN025CB . “five hundred scattered, ceiling two thousand five hundred broken cumulonimbus clouds”
- VV008 “indefinite ceiling eight hundred”

(e) Optional Data (Wind Shear). Wind shear is the forecast of nonconvective low level winds (up to 2,000 feet). The forecast includes the letters “WS” followed by the height of the wind shear, the wind direction and wind speed at the indicated height and the ending letters “KT” (knots). Height is given in hundreds of feet (AGL) up to and including 2,000 feet. Wind shear is encoded with the contraction “WS,” followed by a three-digit height, slant character “/,” and winds at the height indicated in the same format as surface winds. The wind shear element is omitted if not expected to occur.

WS010/18040KT – “LOW LEVEL WIND SHEAR AT ONE THOUSAND, WIND ONE EIGHT ZERO AT FOUR ZERO”

d. Probability Forecast. The probability or chance of thunderstorms or other precipitation events

occurring, along with associated weather conditions (wind, visibility, and sky conditions). The PROB30 group is used when the occurrence of thunderstorms or precipitation is 30–39% and the PROB40 group is used when the occurrence of thunderstorms or precipitation is 40–49%. This is followed by two four-digit groups separated by a “/”, giving the beginning date and hour, and the ending date and hour of the time period during which the thunderstorms or precipitation are expected.

NOTE-

NWS does not use PROB 40 in the TAF. However U.S. Military generated TAFS may include PROB40. PROB30 will not be shown during the first nine hours of a NWS forecast.

EXAMPLE-

- PROB40 2221/2302 1/2SM +TSRA “chance between 2100Z and 0200Z of visibility one-half statute mile in thunderstorms and heavy rain.”
- PROB30 3010/3014 1SM RASN . “chance between 1000Z and 1400Z of visibility one statute mile in mixed rain and snow.”

e. Forecast Change Indicators. The following change indicators are used when either a rapid, gradual, or temporary change is expected in some or all of the forecast meteorological conditions. Each change indicator marks a time group within the TAF report.

1. From (FM) group. The FM group is used when a rapid change, usually occurring in less than one hour, in prevailing conditions is expected. Typically, a rapid change of prevailing conditions to more or less a completely new set of prevailing conditions is associated with a synoptic feature passing through the terminal area (cold or warm frontal passage). Appended to the “FM” indicator is the six-digit date, hour, and minute the change is expected to begin and continues until the next change group or until the end of the current forecast. A “FM” group will mark the beginning of a new line in a TAF report (indented 5 spaces). Each “FM” group contains all the required elements—wind, visibility, weather, and sky condition. Weather will be omitted in “FM” groups when it is not significant to aviation. FM groups will not include the contraction NSW.

EXAMPLE–

FM210100 14010KT P6SM SKC – “after 0100Z on the 21st, wind one four zero at one zero, visibility more than six, sky clear.”

2. Becoming (BECMG) group. The BECMG group is used when a gradual change in conditions is expected over a longer time period, usually two hours. The time period when the change is expected is two four–digit groups separated by a “/”, with the beginning date and hour, and ending date and hour of the change period which follows the BECMG indicator. The gradual change will occur at an unspecified time within this time period. Only the changing forecast meteorological conditions are included in BECMG groups. The omitted conditions are carried over from the previous time group.

NOTE–

The NWS does not use BECMG in the TAF.

EXAMPLE–

OVC012 BECMG 0114/0116 BKN020 – “ceiling one thousand two hundred overcast. Then a gradual change to ceiling two thousand broken between 1400Z on the 1st and 1600Z on the 1st.”

3. Temporary (TEMPO) group. The TEMPO group is used for any conditions in wind, visibility, weather, or sky condition which are expected to last for generally less than an hour at a time (occasional), and are expected to occur during less than half the time period. The TEMPO indicator is followed by two four–digit groups separated by a “/”. The first four digit group gives the beginning date and hour, and the second four digit group gives the ending date and hour of the time period during which the temporary conditions are expected. Only the changing forecast meteorological conditions are included in TEMPO groups. The omitted conditions are carried over from the previous time group.

EXAMPLE–

1. SCT030 TEMPO 0519/0523 BKN030 – “three thousand scattered with occasional ceilings three thousand broken between 1900Z on the 5th and 2300Z on the 5th.”

2. 4SM HZ TEMPO 1900/1906 2SM BR HZ – “visibility four in haze with occasional visibility two in mist and haze between 0000Z on the 19th and 0600Z on the 19th.”

Section 2. Altimeter Setting Procedures

7-2-1. General

a. The accuracy of aircraft altimeters is subject to the following factors:

1. Nonstandard temperatures of the atmosphere.
2. Nonstandard atmospheric pressure.
3. Aircraft static pressure systems (position error); and
4. Instrument error.

b. **EXTREME CAUTION SHOULD BE EXERCISED WHEN FLYING IN PROXIMITY TO OBSTRUCTIONS OR TERRAIN IN LOW TEMPERATURES AND PRESSURES.** This is especially true in extremely cold temperatures that cause a large differential between the Standard Day temperature and actual temperature. This circumstance can cause serious errors that result in the aircraft being significantly lower than the indicated altitude.

NOTE-

Standard temperature at sea level is 15 degrees Celsius (59 degrees Fahrenheit). The temperature gradient from sea level is minus 2 degrees Celsius (3.6 degrees Fahrenheit) per 1,000 feet. Pilots should apply corrections for static pressure systems and/or instruments, if appreciable errors exist.

c. The adoption of a standard altimeter setting at the higher altitudes eliminates station barometer errors, some altimeter instrument errors, and errors caused by altimeter settings derived from different geographical sources.

7-2-2. Procedures

The cruising altitude or flight level of aircraft must be maintained by reference to an altimeter which must be set, when operating:

a. Below 18,000 feet MSL.

1. When the barometric pressure is 31.00 inches Hg. or less. To the current reported altimeter setting of a station along the route and within 100 NM of the aircraft, or if there is no station within this area, the current reported altimeter setting of an appropriate available station. When an aircraft

is en route on an instrument flight plan, air traffic controllers will furnish this information to the pilot at least once while the aircraft is in the controllers area of jurisdiction. In the case of an aircraft not equipped with a radio, set to the elevation of the departure airport or use an appropriate altimeter setting available prior to departure.

2. When the barometric pressure exceeds 31.00 inches Hg. The following procedures will be placed in effect by NOTAM defining the geographic area affected:

(a) For all aircraft. Set 31.00 inches for en route operations below 18,000 feet MSL. Maintain this setting until beyond the affected area or until reaching final approach segment. At the beginning of the final approach segment, the current altimeter setting will be set, if possible. If not possible, 31.00 inches will remain set throughout the approach. Aircraft on departure or missed approach will set 31.00 inches prior to reaching any mandatory/crossing altitude or 1,500 feet AGL, whichever is lower. (Air traffic control will issue actual altimeter settings and advise pilots to set 31.00 inches in their altimeters for en route operations below 18,000 feet MSL in affected areas.)

(b) During preflight, barometric altimeters must be checked for normal operation to the extent possible.

(c) For aircraft with the capability of setting the current altimeter setting and operating into airports with the capability of measuring the current altimeter setting, no additional restrictions apply.

(d) For aircraft operating VFR, there are no additional restrictions, however, extra diligence in flight planning and in operating in these conditions is essential.

(e) Airports unable to accurately measure barometric pressures above 31.00 inches of Hg. will report the barometric pressure as “missing” or “in excess of 31.00 inches of Hg.” Flight operations to and from those airports are restricted to VFR weather conditions.

(f) For aircraft operating IFR and unable to set the current altimeter setting, the following restrictions apply:

(1) To determine the suitability of departure alternate airports, destination airports, and destination alternate airports, increase ceiling requirements by 100 feet and visibility requirements by 1/4 statute mile for each 1/10 of an inch of Hg., or any portion thereof, over 31.00 inches. These adjusted values are then applied in accordance with the requirements of the applicable operating regulations and operations specifications.

EXAMPLE-

Destination altimeter is 31.28 inches, ILS DH 250 feet (200-1/2). When flight planning, add 300-3/4 to the weather requirements which would become 500-1 1/4.

(2) On approach, 31.00 inches will remain set. Decision height (DH) or minimum descent altitude must be deemed to have been reached when the published altitude is displayed on the altimeter.

NOTE-

Although visibility is normally the limiting factor on an approach, pilots should be aware that when reaching DH the aircraft will be higher than indicated. Using the example above the aircraft would be approximately 300 feet higher.

(3) These restrictions do not apply to authorized Category II and III ILS operations nor do they apply to certificate holders using approved QFE altimetry systems.

(g) The FAA Regional Flight Standards Division Manager of the affected area is authorized to approve temporary waivers to permit emergency resupply or emergency medical service operation.

b. **At or above 18,000 feet MSL.** To 29.92 inches of mercury (standard setting). The lowest usable flight level is determined by the atmospheric pressure in the area of operation as shown in TBL 7-2-1.

TBL 7-2-1
Lowest Usable Flight Level

Altimeter Setting (Current Reported)	Lowest Usable Flight Level
29.92 or higher	180
29.91 to 29.42	185
29.41 to 28.92	190
28.91 to 28.42	195
28.41 to 27.92	200

c. Where the minimum altitude, as prescribed in 14 CFR Section 91.159 and 14 CFR Section 91.177, is above 18,000 feet MSL, the lowest usable flight level must be the flight level equivalent of the minimum altitude plus the number of feet specified in TBL 7-2-2.

TBL 7-2-2
Lowest Flight Level Correction Factor

Altimeter Setting	Correction Factor
29.92 or higher	none
29.91 to 29.42	500 feet
29.41 to 28.92	1000 feet
28.91 to 28.42	1500 feet
28.41 to 27.92	2000 feet
27.91 to 27.42	2500 feet

EXAMPLE-

The minimum safe altitude of a route is 19,000 feet MSL and the altimeter setting is reported between 29.92 and 29.42 inches of mercury, the lowest usable flight level will be 195, which is the flight level equivalent of 19,500 feet MSL (minimum altitude plus 500 feet).

7-2-3. Altimeter Errors

a. Most pressure altimeters are subject to mechanical, elastic, temperature, and installation errors. (Detailed information regarding the use of pressure altimeters is found in the Instrument Flying Handbook, Chapter IV.) Although manufacturing and installation specifications, as well as the periodic test and inspections required by regulations (14 CFR Part 43, Appendix E), act to reduce these errors, any scale error may be observed in the following manner:

1. Set the current reported altimeter setting on the altimeter setting scale.

2. Altimeter should now read field elevation if you are located on the same reference level used to establish the altimeter setting.

3. Note the variation between the known field elevation and the altimeter indication. If this variation is in the order of plus or minus 75 feet, the accuracy of the altimeter is questionable and the problem should be referred to an appropriately rated repair station for evaluation and possible correction.

b. Once in flight, it is very important to obtain frequently current altimeter settings en route. If you do not reset your altimeter when flying *from* an area of high pressure into an area of low pressure, *your aircraft will be closer to the surface than your altimeter indicates*. An inch error in the altimeter setting equals 1,000 feet of altitude. To quote an old saying: **“GOING FROM A HIGH TO A LOW, LOOK OUT BELOW.”**

c. Temperature also has an effect on the accuracy of altimeters and your altitude. The crucial values to consider are standard temperature versus the ambient (at altitude) temperature and the elevation above the altitude setting reporting source. It is these “differences” that cause the error in indicated altitude. When the column of air is warmer than standard, you are higher than your altimeter indicates. Subsequently, when the column of air is colder than standard, you are lower than indicated. It is the magnitude of these “differences” that determine the magnitude of the error. When flying into a cooler air mass while maintaining a constant indicated altitude, you are losing true altitude. However, flying into a cooler air mass does not necessarily mean you will be lower than indicated if the *difference* is still on the plus side. For example, while flying at 10,000 feet (where **STANDARD** temperature is -5 degrees

Celsius (C)), the outside air temperature cools from +5 degrees C to 0 degrees C, the temperature error will nevertheless cause the aircraft to be **HIGHER** than indicated. It is the extreme “cold” difference that normally would be of concern to the pilot. Also, when flying in cold conditions over mountainous terrain, the pilot should exercise caution in flight planning both in regard to route and altitude to ensure adequate en route and terminal area terrain clearance.

NOTE-

Non-standard temperatures can result in a change to effective vertical paths and actual descent rates while using aircraft Baro-VNAV equipment for vertical guidance on final approach segments. A higher than standard temperature will result in a steeper gradient and increased actual descent rate. Indications of these differences are often not directly related to vertical speed indications. Conversely, a lower than standard temperature will result in a shallower descent gradient and reduced actual descent rate. Pilots should consider potential consequences of these effects on approach minimums, power settings, sight picture, visual cues, etc., especially for high-altitude or terrain-challenged locations and during low-visibility conditions.

d. TBL 7-2-3, derived from ICAO formulas, indicates how much error can exist when operating in cold temperatures. To use the table, find the reported temperature in the left column, read across the top row to locate the height above the airport/reporting station (i.e., subtract the airport/ reporting elevation from the intended flight altitude). The intersection of the column and row is how much *lower* the aircraft may actually be as a result of the possible cold temperature induced error.

e. Pilots are responsible to compensate for cold temperature altimetry errors when operating into an airport with any published cold temperature restriction and a reported airport temperature at or below the published temperature restriction. Pilots must ensure compensating aircraft are correcting on the proper segment or segments of the approach. Manually correct if compensating aircraft system is inoperable. Pilots manually correcting, are responsible to calculate and apply a cold temperature altitude correction derived from TBL 7-2-3 to the affected approach segment or segments. Pilots must advise the cold temperature altitude correction to Air Traffic Control (ATC). Pilots are not required to advise ATC of a cold temperature altitude correction inside of the final approach fix.

TBL 7-2-3
ICAO Cold Temperature Error Table
Height Above Airport in Feet

	200	300	400	500	600	700	800	900	1000	1500	2000	3000	4000	5000	
Reported Temp °C	+10	10	10	10	10	20	20	20	20	20	30	40	60	80	90
	0	20	20	30	30	40	40	50	50	60	90	120	170	230	280
	-10	20	30	40	50	60	70	80	90	100	150	200	290	390	490
	-20	30	50	60	70	90	100	120	130	140	210	280	420	570	710
	-30	40	60	80	100	120	140	150	170	190	280	380	570	760	950
	-40	50	80	100	120	150	170	190	220	240	360	480	720	970	1210
	-50	60	90	120	150	180	210	240	270	300	450	590	890	1190	1500

EXAMPLE-

Temperature -10 degrees Celsius, and the aircraft altitude is 1,000 feet above the airport elevation. The chart shows that the reported current altimeter setting may place the aircraft as much as 100 feet below the altitude indicated by the altimeter.

7-2-4. High Barometric Pressure

a. Cold, dry air masses may produce barometric pressures in excess of 31.00 inches of Mercury, and many altimeters do not have an accurate means of being adjusted for settings of these levels. When the altimeter cannot be set to the higher pressure setting, the aircraft actual altitude will be higher than the altimeter indicates.

REFERENCE-

AIM, Paragraph 7-2-3, Altimeter Errors.

b. When the barometric pressure exceeds 31.00 inches, air traffic controllers will issue the actual altimeter setting, and:

1. En Route/Arrivals. Advise pilots to remain set on 31.00 inches until reaching the final approach segment.

2. Departures. Advise pilots to set 31.00 inches prior to reaching any mandatory/crossing altitude or 1,500 feet, whichever is lower.

c. The altimeter error caused by the high pressure will be in the opposite direction to the error caused by the cold temperature.

7-2-5. Low Barometric Pressure

When abnormally low barometric pressure conditions occur (below 28.00), flight operations by aircraft unable to set the actual altimeter setting are not recommended.

NOTE-

The true altitude of the aircraft is lower than the indicated altitude if the pilot is unable to set the actual altimeter setting.

Section 3. Wake Turbulence

7-3-1. General

a. Every aircraft generates wake turbulence while in flight. Wake turbulence is a function of an aircraft producing lift, resulting in the formation of two counter-rotating vortices trailing behind the aircraft.

b. Wake turbulence from the generating aircraft can affect encountering aircraft due to the strength, duration, and direction of the vortices. Wake turbulence can impose rolling moments exceeding the roll-control authority of encountering aircraft, causing possible injury to occupants and damage to aircraft. Pilots should always be aware of the possibility of a wake turbulence encounter when flying through the wake of another aircraft, and adjust the flight path accordingly.

7-3-2. Vortex Generation

a. The creation of a pressure differential over the wing surface generates lift. The lowest pressure occurs over the upper wing surface and the highest pressure under the wing. This pressure differential triggers the roll up of the airflow at the rear of the wing resulting in swirling air masses trailing downstream of the wing tips. After the roll up is completed, the wake consists of two counter-rotating cylindrical vortices. (See FIG 7-3-1.) The wake vortex is formed with most of the energy concentrated within a few feet of the vortex core.

FIG 7-3-1
Wake Vortex Generation

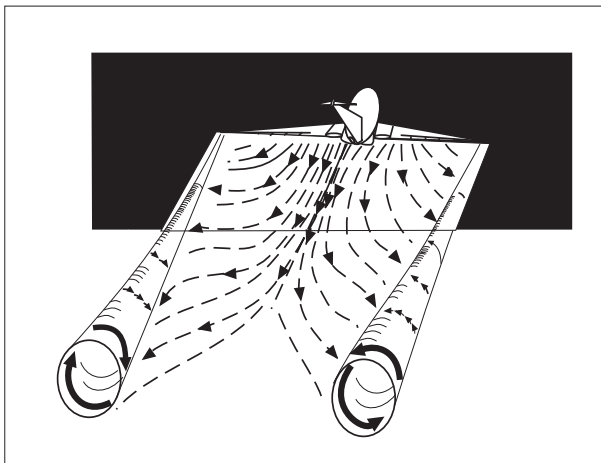

b. More aircraft are being manufactured or retrofitted with winglets. There are several types of winglets, but their primary function is to increase fuel efficiency by improving the lift-to-drag ratio. Studies have shown that winglets have a negligible effect on wake turbulence generation, particularly with the slower speeds involved during departures and arrivals.

7-3-3. Vortex Strength

a. Weight, speed, wingspan, and shape of the generating aircraft's wing all govern the strength of the vortex. The vortex characteristics of any given aircraft can also be changed by extension of flaps or other wing configuring devices. However, the vortex strength from an aircraft increases proportionately to an increase in operating weight or a decrease in aircraft speed. Since the turbulence from a "dirty" aircraft configuration hastens wake decay, the greatest vortex strength occurs when the generating aircraft is HEAVY, CLEAN, and SLOW.

b. Induced Roll

1. In rare instances, a wake encounter could cause catastrophic inflight structural damage to an aircraft. However, the usual hazard is associated with induced rolling moments that can exceed the roll-control authority of the encountering aircraft. During inflight testing, aircraft intentionally flew directly up trailing vortex cores of larger aircraft. These tests demonstrated that the ability of aircraft to counteract the roll imposed by wake vortex depends primarily on the wingspan and counter-control responsiveness of the encountering aircraft. These tests also demonstrated the difficulty of an aircraft to remain within a wake vortex. The natural tendency is for the circulation to eject aircraft from the vortex.

2. Counter control is usually effective and induced roll minimal in cases where the wingspan and ailerons of the encountering aircraft extend beyond the rotational flow field of the vortex. It is more difficult for aircraft with short wingspan (relative to the generating aircraft) to counter the imposed roll induced by vortex flow. Pilots of short span aircraft, even of the high performance type, must be especially alert to vortex encounters. (See FIG 7-3-2.)

FIG 7-3-2
Wake Encounter Counter Control

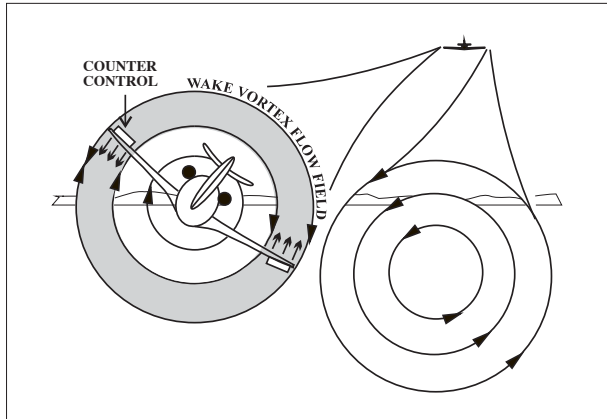

7-3-4. Vortex Behavior

a. Trailing vortices have certain behavioral characteristics which can help a pilot visualize the wake location and thereby take avoidance precautions.

1. An aircraft generates vortices from the moment it rotates on takeoff to touchdown, since trailing vortices are a by-product of wing lift. Prior to takeoff or touchdown pilots should note the rotation or touchdown point of the preceding aircraft. (See FIG 7-3-3.)

2. The vortex circulation is outward, upward and around the wing tips when viewed from either ahead or behind the aircraft. Tests with larger aircraft have shown that the vortices remain spaced a bit less than a wingspan apart, drifting with the wind, at altitudes greater than a wingspan from the ground. In view of this, if persistent vortex turbulence is encountered, a slight change of altitude (upward) and lateral position (upwind) should provide a flight path clear of the turbulence.

3. Flight tests have shown that the vortices from larger aircraft sink at a rate of several hundred feet per minute, slowing their descent and diminishing in strength with time and distance behind the generating aircraft. Pilots should fly at or above the preceding aircraft's flight path, altering course as necessary to avoid the area directly behind and below the generating aircraft. (See FIG 7-3-4.) Pilots, in all phases of flight, must remain vigilant of possible wake effects created by other aircraft. Studies have shown that atmospheric turbulence hastens wake breakup, while other atmospheric conditions can transport wake horizontally and vertically.

4. When the vortices of larger aircraft sink close to the ground (within 100 to 200 feet), they tend to move laterally over the ground at a speed of 2 or 3 knots. (See FIG 7-3-5.)

FIG 7-3-3
Wake Ends/Wake Begins

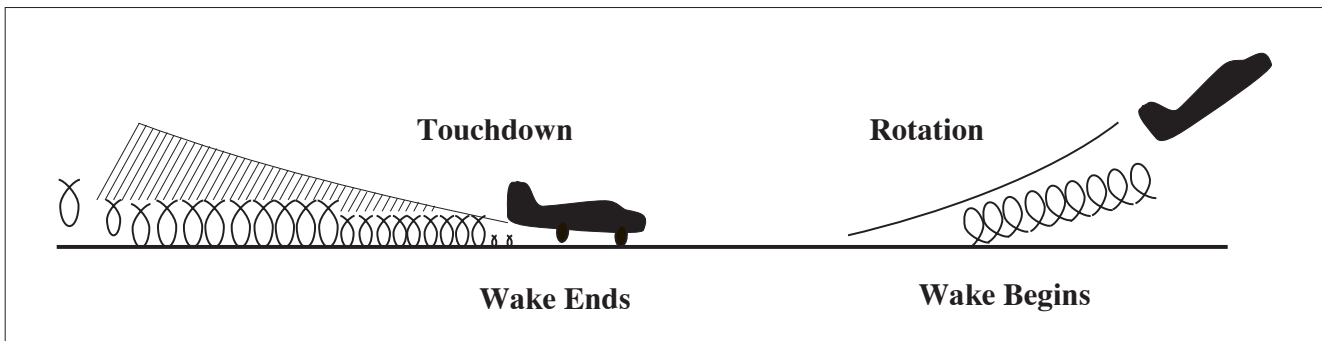

FIG 7-3-4
Vortex Flow Field

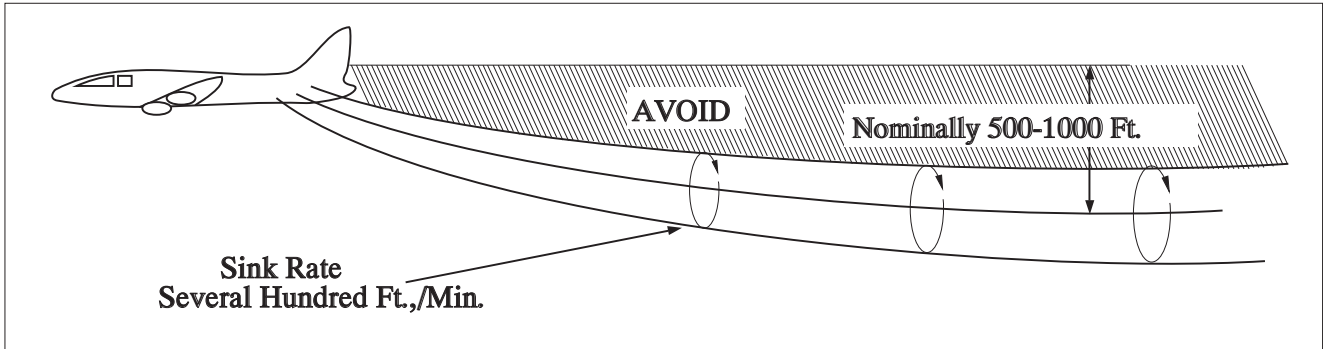

FIG 7-3-5
Vortex Movement Near Ground - No Wind

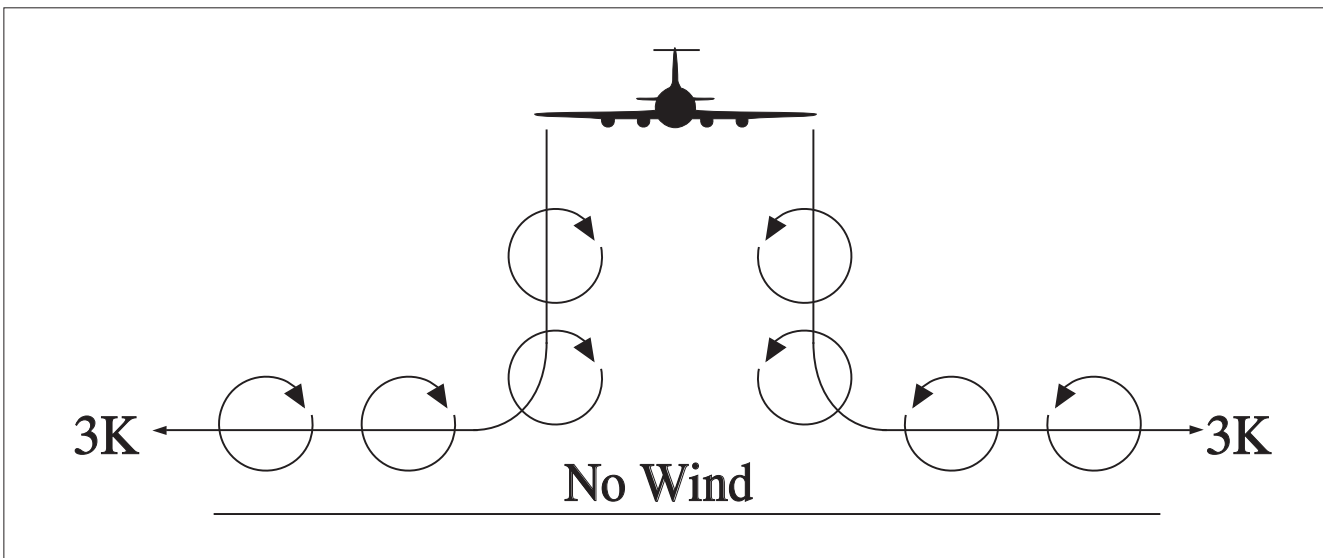
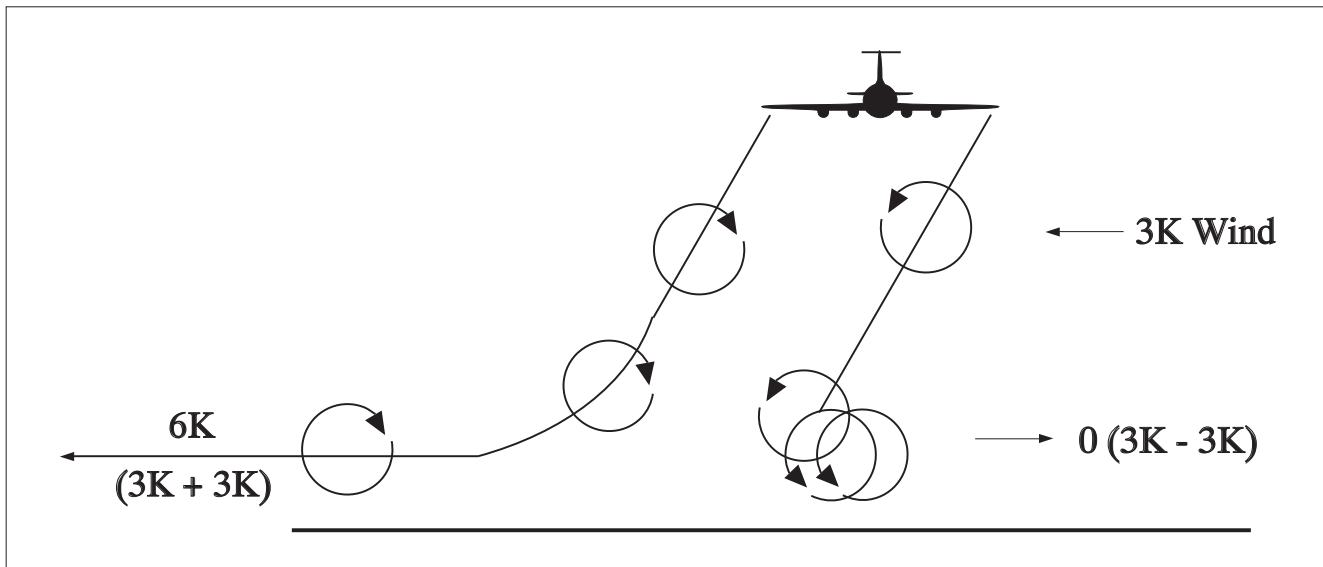

FIG 7-3-6
Vortex Movement Near Ground - with Cross Winds



5. Pilots should be alert at all times for possible wake vortex encounters when conducting approach and landing operations. The pilot is ultimately responsible for maintaining an appropriate interval, and should consider all available information in positioning the aircraft in the terminal area, to avoid the wake turbulence created by a preceding aircraft. Test data shows that vortices can rise with the air mass in which they are embedded. The effects of wind shear can cause vortex flow field “tilting.” In addition, ambient thermal lifting and orographic effects (rising terrain or tree lines) can cause a vortex flow field to rise and possibly bounce.

b. A crosswind will decrease the lateral movement

of the upwind vortex and increase the movement of the downwind vortex. Thus, a light wind with a cross-runway component of 1 to 5 knots could result in the upwind vortex remaining in the touchdown zone for a period of time and hasten the drift of the downwind vortex toward another runway. (See FIG 7-3-6.) Similarly, a tailwind condition can move the vortices of the preceding aircraft forward into the touchdown zone. **THE LIGHT QUARTERING TAILWIND REQUIRES MAXIMUM CAUTION.** Pilots should be alert to large aircraft upwind from their approach and takeoff flight paths. (See FIG 7-3-7.)

FIG 7-3-7
Vortex Movement in Ground Effect – Tailwind

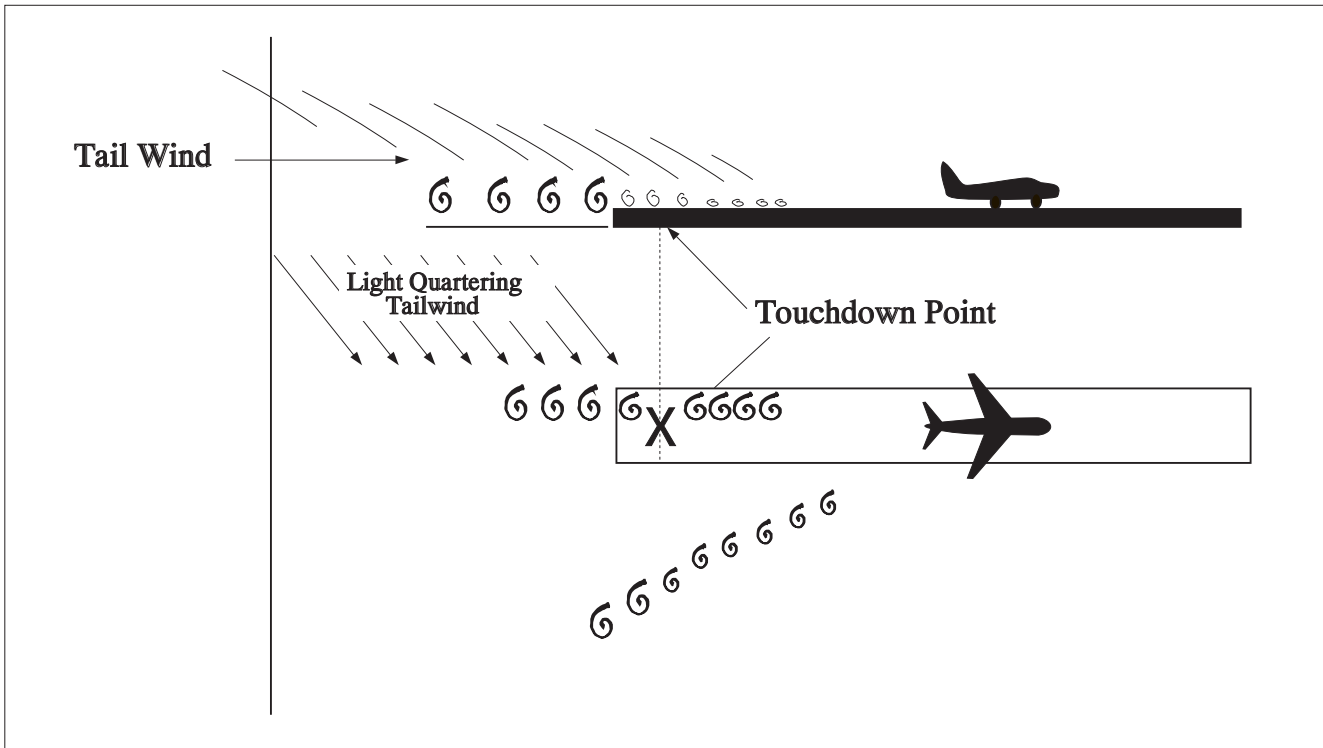

7-3-5. Operations Problem Areas

a. A wake turbulence encounter can range from negligible to catastrophic. The impact of the encounter depends on the weight, wingspan, size of the generating aircraft, distance from the generating aircraft, and point of vortex encounter. The probability of induced roll increases when the encountering aircraft’s heading is generally aligned with the flight path of the generating aircraft.

b. **AVOID THE AREA BELOW AND BEHIND THE WAKE GENERATING AIRCRAFT, ESPECIALLY AT LOW ALTITUDE WHERE EVEN A MOMENTARY WAKE ENCOUNTER COULD BE CATASTROPHIC.**

NOTE-
A common scenario for a wake encounter is in terminal airspace after accepting clearance for a visual approach behind landing traffic. Pilots must be cognizant of their position relative to the traffic and use all means of vertical

guidance to ensure they do not fly below the flight path of the wake generating aircraft.

c. Pilots should be particularly alert in calm wind conditions and situations where the vortices could:

1. Remain in the touchdown area.
2. Drift from aircraft operating on a nearby runway.
3. Sink into the takeoff or landing path from a crossing runway.
4. Sink into the traffic pattern from other airport operations.
5. Sink into the flight path of VFR aircraft operating on the hemispheric altitude 500 feet below.

d. Pilots should attempt to visualize the vortex trail of aircraft whose projected flight path they may encounter. When possible, pilots of larger aircraft should adjust their flight paths to minimize vortex exposure to other aircraft.

7-3-6. Vortex Avoidance Procedures

a. Under certain conditions, airport traffic controllers apply procedures for separating IFR aircraft. If a pilot accepts a clearance to visually follow a preceding aircraft, the pilot accepts responsibility for separation and wake turbulence avoidance. The controllers will also provide to VFR aircraft, with whom they are in communication and which in the tower's opinion may be adversely affected by wake turbulence from a larger aircraft, the position, altitude and direction of flight of larger aircraft followed by the phrase "CAUTION – WAKE TURBULENCE." After issuing the caution for wake turbulence, the airport traffic controllers generally do not provide additional information to the following aircraft unless the airport traffic controllers know the following aircraft is overtaking the preceding aircraft. **WHETHER OR NOT A WARNING OR INFORMATION HAS BEEN GIVEN, HOWEVER, THE PILOT IS EXPECTED TO ADJUST AIRCRAFT OPERATIONS AND FLIGHT PATH AS NECESSARY TO PRECLUDE SERIOUS WAKE ENCOUNTERS.** When any doubt exists about maintaining safe separation distances between aircraft during approaches, pilots should ask the control tower for updates on separation distance and aircraft groundspeed.

b. The following vortex avoidance procedures are recommended for the various situations:

1. Landing behind a larger aircraft– same runway. Stay at or above the larger aircraft's final approach flight path–note its touchdown point–land beyond it.

2. Landing behind a larger aircraft– when parallel runway is closer than 2,500 feet. Consider possible drift to your runway. Stay at or above the larger aircraft's final approach flight path– note its touchdown point.

3. Landing behind a larger aircraft– crossing runway. Cross above the larger aircraft's flight path.

4. Landing behind a departing larger aircraft– same runway. Note the larger aircraft's rotation point– land well prior to rotation point.

5. Landing behind a departing larger aircraft– crossing runway. Note the larger aircraft's rotation point– if past the intersection– continue the approach– land prior to the intersection. If larger aircraft rotates prior to the intersection, avoid flight below the larger aircraft's flight path. Abandon the approach unless a landing is ensured well before reaching the intersection.

6. Departing behind a larger aircraft. Note the larger aircraft's rotation point and rotate prior to the larger aircraft's rotation point. Continue climbing above the larger aircraft's climb path until turning clear of the larger aircraft's wake. Avoid subsequent headings which will cross below and behind a larger aircraft. Be alert for any critical takeoff situation which could lead to a vortex encounter.

7. Intersection takeoffs– same runway. Be alert to adjacent larger aircraft operations, particularly upwind of your runway. If intersection takeoff clearance is received, avoid subsequent heading which will cross below a larger aircraft's path.

8. Departing or landing after a larger aircraft executing a low approach, missed approach, or touch-and-go landing. Because vortices settle and move laterally near the ground, the vortex hazard may exist along the runway and in your flight path after a larger aircraft has executed a low approach, missed approach, or a touch-and-go landing, particular in light quartering wind conditions. You should ensure that an interval of at least 2 minutes has elapsed before your takeoff or landing.

9. En route VFR (thousand-foot altitude plus 500 feet). Avoid flight below and behind a large aircraft's path. If a larger aircraft is observed above on the same track (meeting or overtaking) adjust your position laterally, preferably upwind.

7-3-7. Helicopters

In a slow hover taxi or stationary hover near the surface, helicopter main rotor(s) generate downwash producing high velocity outwash vortices to a distance approximately three times the diameter of the rotor. When rotor downwash hits the surface, the resulting outwash vortices have behavioral characteristics similar to wing tip vortices produced by fixed wing aircraft. However, the vortex circulation is outward, upward, around, and away from the main rotor(s) in all directions. Pilots of small aircraft should avoid operating within three rotor diameters of any helicopter in a slow hover taxi or stationary hover. In forward flight, departing or landing helicopters produce a pair of strong, high-speed trailing vortices similar to wing tip vortices of larger fixed wing aircraft. Pilots of small aircraft should use caution when operating behind or crossing behind landing and departing helicopters.

7-3-8. Pilot Responsibility

a. Research and testing have been conducted, in addition to ongoing wake initiatives, in an attempt to mitigate the effects of wake turbulence. Pilots must exercise vigilance in situations where they are responsible for avoiding wake turbulence.

b. Pilots are reminded that in operations conducted behind all aircraft, acceptance of instructions from ATC in the following situations is an acknowledgment that the pilot will ensure safe takeoff and landing intervals and accepts the responsibility for providing wake turbulence separation.

1. Traffic information.
2. Instructions to follow an aircraft; and
3. The acceptance of a visual approach clearance.

c. For operations conducted behind **super** or **heavy** aircraft, ATC will specify the word "**super**" or "**heavy**" as appropriate, when this information is

known. Pilots of **super** or **heavy** aircraft should always use the word "**super**" or "**heavy**" in radio communications.

d. Super, heavy, and large jet aircraft operators should use the following procedures during an approach to landing. These procedures establish a dependable baseline from which pilots of in-trail, lighter aircraft may reasonably expect to make effective flight path adjustments to avoid serious wake vortex turbulence.

1. Pilots of aircraft that produce strong wake vortices should make every attempt to fly on the established glidepath, not above it; or, if glidepath guidance is not available, to fly as closely as possible to a "3-1" glidepath, not above it.

EXAMPLE-

Fly 3,000 feet at 10 miles from touchdown, 1,500 feet at 5 miles, 1,200 feet at 4 miles, and so on to touchdown.

2. Pilots of aircraft that produce strong wake vortices should fly as closely as possible to the approach course centerline or to the extended centerline of the runway of intended landing as appropriate to conditions.

e. Pilots operating lighter aircraft on visual approaches in-trail to aircraft producing strong wake vortices should use the following procedures to assist in avoiding wake turbulence. These procedures apply only to those aircraft that are on visual approaches.

1. Pilots of lighter aircraft should fly on or above the glidepath. Glidepath reference may be furnished by an ILS, by a visual approach slope system, by other ground-based approach slope guidance systems, or by other means. In the absence of visible glidepath guidance, pilots may very nearly duplicate a 3-degree glideslope by adhering to the "3 to 1" glidepath principle.

EXAMPLE-

Fly 3,000 feet at 10 miles from touchdown, 1,500 feet at 5 miles, 1,200 feet at 4 miles, and so on to touchdown.

2. If the pilot of the lighter following aircraft has visual contact with the preceding heavier aircraft and also with the runway, the pilot may further adjust for possible wake vortex turbulence by the following practices:

(a) Pick a point of landing no less than 1,000 feet from the arrival end of the runway.

(b) Establish a line-of-sight to that landing point that is above and in front of the heavier preceding aircraft.

(c) When possible, note the point of landing of the heavier preceding aircraft and adjust point of intended landing as necessary.

EXAMPLE-

A puff of smoke may appear at the 1,000-foot markings of the runway, showing that touchdown was that point; therefore, adjust point of intended landing to the 1,500-foot markings.

(d) Maintain the line-of-sight to the point of intended landing above and ahead of the heavier preceding aircraft; maintain it to touchdown.

(e) Land beyond the point of landing of the preceding heavier aircraft. Ensure you have adequate runway remaining, if conducting a touch-and-go landing, or adequate stopping distance available for a full stop landing.

f. During visual approaches pilots may ask ATC for updates on separation and groundspeed with respect to heavier preceding aircraft, especially when there is any question of safe separation from wake turbulence.

g. Pilots should notify ATC when a wake event is encountered. Be as descriptive as possible (i.e., bank angle, altitude deviations, intensity and duration of event, etc.) when reporting the event. ATC will record the event through their reporting system. You are also encouraged to use the Aviation Safety Reporting System (ASRS) to report wake events.

7-3-9. Air Traffic Wake Turbulence Separations

a. Because of the possible effects of wake turbulence, controllers are required to apply no less than minimum required separation to all aircraft operating behind a Super or Heavy, and to Small aircraft operating behind a B757, when aircraft are IFR; VFR and receiving Class B, Class C, or TRSA airspace services; or VFR and being radar sequenced.

1. Separation is applied to aircraft operating directly behind a super or heavy at the same altitude or less than 1,000 feet below, and to small aircraft operating directly behind a B757 at the same altitude or less than 500 feet below:

(a) **Heavy** behind **super** – 6 miles.

(b) **Large** behind **super** – 7 miles.

(c) **Small** behind **super** – 8 miles.

(d) **Heavy** behind **heavy** – 4 miles.

(e) **Small/large** behind **heavy** – 5 miles.

(f) **Small** behind **B757** – 4 miles.

2. Also, separation, measured at the time the preceding aircraft is over the landing threshold, is provided to small aircraft:

(a) **Small** landing behind **heavy** – 6 miles.

(b) **Small** landing behind **large, non-B757** – 4 miles.

REFERENCE-

Pilot/Controller Glossary Term- Aircraft Classes.

b. Additionally, appropriate time or distance intervals are provided to departing aircraft when the departure will be from the same threshold, a parallel runway separated by less than 2,500 feet with less than 500 feet threshold stagger, or on a crossing runway and projected flight paths will cross:

1. Three minutes or the appropriate radar separation when takeoff will be behind a super aircraft;

2. Two minutes or the appropriate radar separation when takeoff will be behind a heavy aircraft.

3. Two minutes or the appropriate radar separation when a small aircraft will takeoff behind a B757.

NOTE-

Controllers may not reduce or waive these intervals.

c. A 3-minute interval will be provided when a **small** aircraft will takeoff:

1. From an intersection on the same runway (same or opposite direction) behind a departing **large** aircraft (except B757), or

2. In the opposite direction on the same runway behind a large aircraft (except B757) takeoff or low/missed approach.

NOTE-

This 3-minute interval may be waived upon specific pilot request.

d. A 3-minute interval will be provided when a **small** aircraft will takeoff:

1. From an intersection on the same runway (same or opposite direction) behind a departing B757, or

2. In the opposite direction on the same runway behind a B757 takeoff or low/missed approach.

NOTE—

This 3-minute interval may not be waived.

e. A 4-minute interval will be provided for all aircraft taking off behind a super aircraft, and a 3-minute interval will be provided for all aircraft taking off behind a heavy aircraft when the operations are as described in subparagraphs c1 and c2 above, and are conducted on either the same runway or parallel runways separated by less than 2,500 feet. Controllers may not reduce or waive this interval.

f. Pilots may request additional separation (i.e., 2 minutes instead of 4 or 5 miles) for wake turbulence avoidance. This request should be made as soon as practical on ground control and at least before taxiing onto the runway.

NOTE—

14 CFR Section 91.3(a) states: “The pilot-in-command of an aircraft is directly responsible for and is the final authority as to the operation of that aircraft.”

g. Controllers may anticipate separation and need not withhold a takeoff clearance for an aircraft departing behind a **large, heavy, or super** aircraft if there is reasonable assurance the required separation will exist when the departing aircraft starts takeoff roll.

NOTE—

With the advent of new wake turbulence separation methodologies known as Wake Turbulence Recategoriza-

tion, some of the requirements listed above may vary at facilities authorized to operate in accordance with Wake Turbulence Recategorization directives.

REFERENCE—

FAA Order JO 7110.659 Wake Turbulence Recategorization

FAA Order JO 7110.123 Wake Turbulence Recategorization – Phase II

FAA Order JO 7110.126, Consolidated Wake Turbulence

7-3-10. Development and New Capabilities

a. The suite of available wake turbulence tools, rules, and procedures is expanding, with the development of new methodologies. Based on extensive analysis of wake vortex behavior, new procedures and separation standards are being developed and implemented in the US and throughout the world. Wake research involves the wake generating aircraft as well as the wake toleration of the trailing aircraft.

b. The FAA and ICAO are leading initiatives, in terminal environments, to implement next-generation wake turbulence procedures and separation standards. The FAA has undertaken an effort to recategorize the existing fleet of aircraft and modify associated wake turbulence separation minima. This initiative is termed Wake Turbulence Recategorization (RECAT), and changes the current weight-based classes (Super, Heavy, B757, Large, Small+, and Small) to a wake-based categorical system that utilizes the aircraft matrices of weight, wingspan, and approach speed. RECAT is currently in use at a limited number of airports in the National Airspace System.

Section 4. Bird Hazards and Flight Over National Refuges, Parks, and Forests

7-4-1. Migratory Bird Activity

a. Bird strike risk increases because of bird migration during the months of March through April, and August through November.

b. The altitudes of migrating birds vary with winds aloft, weather fronts, terrain elevations, cloud conditions, and other environmental variables. While over 90 percent of the reported bird strikes occur at or below 3,000 feet AGL, strikes at higher altitudes are common during migration. Ducks and geese are frequently observed up to 7,000 feet AGL and pilots are cautioned to minimize en route flying at lower altitudes during migration.

c. Considered the greatest potential hazard to aircraft because of their size, abundance, or habit of flying in dense flocks are gulls, waterfowl, vultures, hawks, owls, egrets, blackbirds, and starlings. Four major migratory flyways exist in the U.S. The Atlantic flyway parallels the Atlantic Coast. The Mississippi Flyway stretches from Canada through the Great Lakes and follows the Mississippi River. The Central Flyway represents a broad area east of the Rockies, stretching from Canada through Central America. The Pacific Flyway follows the west coast and overflies major parts of Washington, Oregon, and California. There are also numerous smaller flyways which cross these major north-south migratory routes.

7-4-2. Reducing Bird Strike Risks

a. The most serious strikes are those involving ingestion into an engine (turboprops and turbine jet engines) or windshield strikes. These strikes can result in emergency situations requiring prompt action by the pilot.

b. Engine ingestions may result in sudden loss of power or engine failure. Review engine out procedures, especially when operating from airports with known bird hazards or when operating near high bird concentrations.

c. Windshield strikes have resulted in pilots experiencing confusion, disorientation, loss of communications, and aircraft control problems. Pilots are encouraged to review their emergency procedures before flying in these areas.

d. When encountering birds en route, climb to avoid collision, because birds in flocks generally distribute themselves downward, with lead birds being at the highest altitude.

e. Avoid overflight of known areas of bird concentration and flying at low altitudes during bird migration. Chared wildlife refuges and other natural areas contain unusually high local concentration of birds which may create a hazard to aircraft.

7-4-3. Reporting Bird Strikes

Pilots are urged to report any bird or other wildlife strike using FAA Form 5200-7, Bird/Other Wildlife Strike Report (Appendix 1). Additional forms are available at any FSS; at any FAA Regional Office or at https://www.faa.gov/airports/airport_safety/wildlife/. The data derived from these reports are used to develop standards to cope with this potential hazard to aircraft and for documentation of necessary habitat control on airports.

7-4-4. Reporting Bird and Other Wildlife Activities

If you observe birds or other animals on or near the runway, request airport management to disperse the wildlife before taking off. Also contact the nearest FAA ARTCC, FSS, or tower (including non-Federal towers) regarding large flocks of birds and report the:

- a. Geographic location.
- b. Bird type (geese, ducks, gulls, etc.).
- c. Approximate numbers.
- d. Altitude.
- e. Direction of bird flight path.

7-4-5. Pilot Advisories on Bird and Other Wildlife Hazards

Many airports advise pilots of other wildlife hazards caused by large animals on the runway through the Chart Supplement U.S. and the NOTAM system. Collisions of landing and departing aircraft and animals on the runway are increasing and are not limited to rural airports. These accidents have also occurred at several major airports. Pilots should exercise extreme caution when warned of the presence of wildlife on and in the vicinity of airports. If you observe deer or other large animals in close proximity to movement areas, advise the FSS, tower, or airport management.

7-4-6. Flights Over Charted U.S. Wildlife Refuges, Parks, and Forest Service Areas

a. The landing of aircraft is prohibited on lands or waters administered by the National Park Service, U.S. Fish and Wildlife Service, or U.S. Forest Service without authorization from the respective agency. Exceptions include:

1. When forced to land due to an emergency beyond the control of the operator;
2. At officially designated landing sites; or
3. An approved official business of the Federal Government.

b. Pilots are requested to maintain a minimum altitude of 2,000 feet above the surface of the following: National Parks, Monuments, Seashores,

Lakeshores, Recreation Areas and Scenic Riverways administered by the National Park Service, National Wildlife Refuges, Big Game Refuges, Game Ranges and Wildlife Ranges administered by the U.S. Fish and Wildlife Service, and Wilderness and Primitive areas administered by the U.S. Forest Service.

NOTE-

FAA Advisory Circular AC 91-36, Visual Flight Rules (VFR) Flight Near Noise-Sensitive Areas, defines the surface of a national park area (including parks, forests, primitive areas, wilderness areas, recreational areas, national seashores, national monuments, national lakeshores, and national wildlife refuge and range areas) as: the highest terrain within 2,000 feet laterally of the route of flight, or the upper-most rim of a canyon or valley.

c. Federal statutes prohibit certain types of flight activity and/or provide altitude restrictions over designated U.S. Wildlife Refuges, Parks, and Forest Service Areas. These designated areas, for example: Boundary Waters Canoe Wilderness Areas, Minnesota; Haleakala National Park, Hawaii; Yosemite National Park, California; and Grand Canyon National Park, Arizona, are charted on Sectional Charts.

d. Federal regulations also prohibit airdrops by parachute or other means of persons, cargo, or objects from aircraft on lands administered by the three agencies without authorization from the respective agency. Exceptions include:

1. Emergencies involving the safety of human life; or
2. Threat of serious property loss.

Section 5. Potential Flight Hazards

7-5-1. Accident Cause Factors

a. The 10 most frequent cause factors for general aviation accidents that involve the pilot-in-command are:

1. **Inadequate preflight preparation and/or planning.**
2. **Failure to obtain and/or maintain flying speed.**
3. **Failure to maintain direction control.**
4. **Improper level off.**
5. **Failure to see and avoid objects or obstructions.**
6. **Mismanagement of fuel.**
7. **Improper inflight decisions or planning.**
8. **Misjudgment of distance and speed.**
9. **Selection of unsuitable terrain.**
10. **Improper operation of flight controls.**

b. This list remains relatively stable and points out the need for continued refresher training to establish a higher level of flight proficiency for all pilots. A part of the FAA's continuing effort to promote increased aviation safety is the Aviation Safety Program. For information on Aviation Safety Program activities contact your nearest Flight Standards District Office.

c. **Alertness.** Be alert at all times, especially when the weather is good. Most pilots pay attention to business when they are operating in full IFR weather conditions, but strangely, air collisions almost invariably have occurred under ideal weather conditions. Unlimited visibility appears to encourage a sense of security which is not at all justified. Considerable information of value may be obtained by listening to advisories being issued in the terminal area, even though controller workload may prevent a pilot from obtaining individual service.

d. **Giving Way.** If you think another aircraft is too close to you, give way instead of waiting for the other pilot to respect the right-of-way to which you may be

entitled. It is a lot safer to pursue the right-of-way angle after you have completed your flight.

7-5-2. VFR in Congested Areas

A high percentage of near midair collisions occur below 8,000 feet AGL and within 30 miles of an airport. When operating VFR in these highly congested areas, whether you intend to land at an airport within the area or are just flying through, it is recommended that extra vigilance be maintained and that you monitor an appropriate control frequency. Normally the appropriate frequency is an approach control frequency. By such monitoring action you can "get the picture" of the traffic in your area. When the approach controller has radar, radar traffic advisories may be given to VFR pilots upon request.

REFERENCE-

AIM, Paragraph 4-1-15, Radar Traffic Information Service

7-5-3. Obstructions To Flight

a. **General.** Many structures exist that could significantly affect the safety of your flight when operating below 500 feet AGL, and particularly below 200 feet AGL. While 14 CFR Part 91.119 allows flight below 500 AGL when over sparsely populated areas or open water, such operations are very dangerous. At and below 200 feet AGL there are numerous power lines, antenna towers, etc., that are not marked and lighted as obstructions and; therefore, may not be seen in time to avoid a collision. Notices to Airmen (NOTAMs) are issued on those lighted structures experiencing temporary light outages. However, some time may pass before the FAA is notified of these outages, and the NOTAM issued, thus pilot vigilance is imperative.

b. **Antenna Towers.** Extreme caution should be exercised when flying less than 2,000 feet AGL because of numerous skeletal structures, such as radio and television antenna towers, that exceed 1,000 feet AGL with some extending higher than 2,000 feet AGL. Most skeletal structures are supported by guy wires which are very difficult to see in good weather and can be invisible at dusk or during periods of reduced visibility. These wires can extend about 1,500 feet horizontally from a structure; therefore, all skeletal structures should be avoided horizontally by

at least 2,000 feet. Additionally, new towers may not be on your current chart because the information was not received prior to the printing of the chart.

c. Overhead Wires. Overhead transmission and utility lines often span approaches to runways, natural flyways such as lakes, rivers, gorges, and canyons, and cross other landmarks pilots frequently follow such as highways, railroad tracks, etc. As with antenna towers, these high voltage/power lines or the supporting structures of these lines may not always be readily visible and the wires may be virtually impossible to see under certain conditions. In some locations, the supporting structures of overhead transmission lines are equipped with unique sequence flashing white strobe light systems to indicate that there are wires between the structures. However, many power lines do not require notice to the FAA and, therefore, are not marked and/or lighted. Many of those that do require notice do not exceed 200 feet AGL or meet the Obstruction Standard of 14 CFR Part 77 and, therefore, are not marked and/or lighted. All pilots are cautioned to remain extremely vigilant for these power lines or their supporting structures when following natural flyways or during the approach and landing phase. This is particularly important for seaplane and/or float equipped aircraft when landing on, or departing from, unfamiliar lakes or rivers.

d. Other Objects/Structures. There are other objects or structures that could adversely affect your flight such as construction cranes near an airport, newly constructed buildings, new towers, etc. Many of these structures do not meet charting requirements or may not yet be charted because of the charting cycle. Some structures do not require obstruction marking and/or lighting and some may not be marked and lighted even though the FAA recommended it.

7-5-4. Avoid Flight Beneath Unmanned Balloons

a. The majority of unmanned free balloons currently being operated have, extending below them, either a suspension device to which the payload or instrument package is attached, or a trailing wire antenna, or both. In many instances these balloon subsystems may be invisible to the pilot until the aircraft is close to the balloon, thereby creating a potentially dangerous situation. Therefore, good judgment on the part of the pilot dictates that aircraft

should remain well clear of all unmanned free balloons and flight below them should be avoided at all times.

b. Pilots are urged to report any unmanned free balloons sighted to the nearest FAA ground facility with which communication is established. Such information will assist FAA ATC facilities to identify and flight follow unmanned free balloons operating in the airspace.

7-5-5. Unmanned Aircraft Systems

a. Unmanned Aircraft Systems (UAS), formerly referred to as “Unmanned Aerial Vehicles” (UAVs) or “drones,” are having an increasing operational presence in the NAS. Once the exclusive domain of the military, UAS are now being operated by various entities. Although these aircraft are “unmanned,” UAS are flown by a remotely located pilot and crew. Physical and performance characteristics of unmanned aircraft (UA) vary greatly and unlike model aircraft that typically operate lower than 400 feet AGL, UA may be found operating at virtually any altitude and any speed. Sizes of UA can be as small as several pounds to as large as a commercial transport aircraft. UAS come in various categories including airplane, rotorcraft, powered-lift (tilt-rotor), and lighter-than-air. Propulsion systems of UAS include a broad range of alternatives from piston powered and turbojet engines to battery and solar-powered electric motors.

b. To ensure segregation of UAS operations from other aircraft, the military typically conducts UAS operations within restricted or other special use airspace. However, UAS operations are now being approved in the NAS outside of special use airspace through the use of FAA-issued Certificates of Waiver or Authorization (COA) or through the issuance of a special airworthiness certificate. COA and special airworthiness approvals authorize UAS flight operations to be contained within specific geographic boundaries and altitudes, usually require coordination with an ATC facility, and typically require the issuance of a NOTAM describing the operation to be conducted. UAS approvals also require observers to provide “see-and-avoid” capability to the UAS crew and to provide the necessary compliance with 14 CFR Section 91.113. For UAS operations approved at or above FL180, UAS operate under the same requirements as that of manned aircraft (i.e., flights

are operated under instrument flight rules, are in communication with ATC, and are appropriately equipped).

c. UAS operations may be approved at either controlled or uncontrolled airports and are typically disseminated by NOTAM. In all cases, approved UAS operations must comply with all applicable regulations and/or special provisions specified in the COA or in the operating limitations of the special airworthiness certificate. At uncontrolled airports, UAS operations are advised to operate well clear of all known manned aircraft operations. Pilots of manned aircraft are advised to follow normal operating procedures and are urged to monitor the CTAF for any potential UAS activity. At controlled airports, local ATC procedures may be in place to handle UAS operations and should not require any special procedures from manned aircraft entering or departing the traffic pattern or operating in the vicinity of the airport.

d. In addition to approved UAS operations described above, a recently approved agreement between the FAA and the Department of Defense authorizes small UAS operations wholly contained within Class G airspace, and in no instance, greater than 1200 feet AGL over military owned or leased property. These operations do not require any special authorization as long as the UA remains within the lateral boundaries of the military installation as well as other provisions including the issuance of a NOTAM. Unlike special use airspace, these areas may not be depicted on an aeronautical chart.

e. There are several factors a pilot should consider regarding UAS activity in an effort to reduce potential flight hazards. Pilots are urged to exercise increased vigilance when operating in the vicinity of restricted or other special use airspace, military operations areas, and any military installation. Areas with a preponderance of UAS activity are typically noted on sectional charts advising pilots of this activity. Since the size of a UA can be very small, they may be difficult to see and track. If a UA is encountered during flight, as with manned aircraft, never assume that the pilot or crew of the UAS can see you, maintain increased vigilance with the UA and always be prepared for evasive action if necessary. Always check NOTAMs for potential UAS activity along the intended route of flight and exercise increased vigilance in areas specified in the NOTAM.

7-5-6. Mountain Flying

a. Your first experience of flying over mountainous terrain (particularly if most of your flight time has been over the flatlands of the midwest) could be a *never-to-be-forgotten nightmare* if proper planning is not done and if you are not aware of the potential hazards awaiting. Those familiar section lines are not present in the mountains; those flat, level fields for forced landings are practically nonexistent; abrupt changes in wind direction and velocity occur; severe updrafts and downdrafts are common, particularly near or above abrupt changes of terrain such as cliffs or rugged areas; even the clouds look different and can build up with startling rapidity. Mountain flying need not be hazardous if you follow the recommendations below.

b. **File a Flight Plan.** Plan your route to avoid topography which would prevent a safe forced landing. The route should be over populated areas and well known mountain passes. Sufficient altitude should be maintained to permit gliding to a safe landing in the event of engine failure.

c. Don't fly a light aircraft when the winds aloft, at your proposed altitude, exceed 35 miles per hour. Expect the winds to be of much greater velocity over mountain passes than reported a few miles from them. Approach mountain passes with as much altitude as possible. Downdrafts of from 1,500 to 2,000 feet per minute are not uncommon on the leeward side.

d. Don't fly near or above abrupt changes in terrain. Severe turbulence can be expected, especially in high wind conditions.

e. **Understand Mountain Obscuration.** The term Mountain Obscuration (MTOS) is used to describe a visibility condition that is distinguished from IFR because ceilings, by definition, are described as "above ground level" (AGL). In mountainous terrain clouds can form at altitudes significantly higher than the weather reporting station and at the same time nearby mountaintops may be obscured by low visibility. In these areas the ground level can also vary greatly over a small area. Beware if operating VFR-on-top. You could be operating closer to the terrain than you think because the tops of mountains are hidden in a cloud deck below. MTOS areas are identified daily on The Aviation Weather Center located at:

<http://www.aviationweather.gov>

f. Some canyons run into a dead end. Don't fly so far up a canyon that you get trapped. **ALWAYS BE ABLE TO MAKE A 180 DEGREE TURN!**

g. VFR flight operations may be conducted at night in mountainous terrain with the application of sound judgment and common sense. Proper pre-flight planning, giving ample consideration to winds and weather, knowledge of the terrain and pilot experience in mountain flying are prerequisites for safety of flight. Continuous visual contact with the surface and obstructions is a major concern and flight operations under an overcast or in the vicinity of clouds should be approached with extreme caution.

h. When landing at a high altitude field, the same indicated airspeed should be used as at low elevation fields. *Remember:* that due to the less dense air at altitude, this same indicated airspeed actually results in higher true airspeed, a faster landing speed, and more important, a longer landing distance. During gusty wind conditions which often prevail at high altitude fields, a power approach and power landing is recommended. Additionally, due to the faster groundspeed, your takeoff distance will increase considerably over that required at low altitudes.

i. Effects of Density Altitude. Performance figures in the aircraft owner's handbook for length of takeoff run, horsepower, rate of climb, etc., are generally based on standard atmosphere conditions (59 degrees Fahrenheit (15 degrees Celsius), pressure 29.92 inches of mercury) at sea level. However, inexperienced pilots, as well as experienced pilots, may run into trouble when they encounter an altogether different set of conditions. This is particularly true in hot weather and at higher elevations. Aircraft operations at altitudes above sea level and at higher than standard temperatures are commonplace in mountainous areas. Such operations quite often result in a drastic reduction of aircraft performance capabilities because of the changing air density. Density altitude is a measure of air density. It is not to be confused with pressure altitude, true altitude or absolute altitude. It is not to be used as a height reference, but as a determining criteria in the performance capability of an aircraft. Air density

decreases with altitude. As air density decreases, density altitude increases. The further effects of high temperature and high humidity are cumulative, resulting in an increasing high density altitude condition. High density altitude reduces all aircraft performance parameters. To the pilot, this means that the normal horsepower output is reduced, propeller efficiency is reduced and a higher true airspeed is required to sustain the aircraft throughout its operating parameters. It means an increase in runway length requirements for takeoff and landings, and decreased rate of climb. An average small airplane, for example, requiring 1,000 feet for takeoff at sea level under standard atmospheric conditions will require a takeoff run of approximately 2,000 feet at an operational altitude of 5,000 feet.

NOTE-

A turbo-charged aircraft engine provides some slight advantage in that it provides sea level horsepower up to a specified altitude above sea level.

1. Density Altitude Advisories. At airports with elevations of 2,000 feet and higher, control towers and FSSs will broadcast the advisory "Check Density Altitude" when the temperature reaches a predetermined level. These advisories will be broadcast on appropriate tower frequencies or, where available, ATIS. FSSs will broadcast these advisories as a part of Local Airport Advisory, and on TWEB.

2. These advisories are provided by air traffic facilities, as a reminder to pilots that high temperatures and high field elevations will cause significant changes in aircraft characteristics. The pilot retains the responsibility to compute density altitude, when appropriate, as a part of preflight duties.

NOTE-

All FSSs will compute the current density altitude upon request.

j. Mountain Wave. Many pilots go all their lives without understanding what a mountain wave is. Quite a few have lost their lives because of this lack of understanding. One need not be a licensed meteorologist to understand the mountain wave phenomenon.

1. Mountain waves occur when air is being blown over a mountain range or even the ridge of a sharp bluff area. As the air hits the upwind side of the range, it starts to climb, thus creating what is generally a smooth updraft which turns into a turbulent downdraft as the air passes the crest of the ridge. From this point, for many miles downwind, there will be a series of downdrafts and updrafts. Satellite photos of the Rockies have shown mountain waves extending as far as 700 miles downwind of the range. Along the east coast area, such photos of the Appalachian chain have picked up the mountain wave phenomenon over a hundred miles eastward. All it takes to form a mountain wave is wind blowing across the range at 15 knots or better at an intersection angle of not less than 30 degrees.

2. Pilots from flatland areas should understand a few things about mountain waves in order to stay out of trouble. When approaching a mountain range from the upwind side (generally the west), there will usually be a smooth updraft; therefore, it is not quite as dangerous an area as the lee of the range. From the leeward side, it is always a good idea to add an extra thousand feet or so of altitude because downdrafts can exceed the climb capability of the aircraft. Never expect an updraft when approaching a mountain chain from the leeward. Always be prepared to cope with a downdraft and turbulence.

3. When approaching a mountain ridge from the downwind side, it is recommended that the ridge be approached at approximately a 45 degree angle to the horizontal direction of the ridge. This permits a safer retreat from the ridge with less stress on the aircraft should severe turbulence and downdraft be experienced. If severe turbulence is encountered, simultaneously reduce power and adjust pitch until aircraft approaches maneuvering speed, then adjust power and trim to maintain maneuvering speed and fly away from the turbulent area.

7-5-7. Use of Runway Half-way Signs at Unimproved Airports

When installed, runway half-way signs provide the pilot with a reference point to judge takeoff acceleration trends. Assuming that the runway length is appropriate for takeoff (considering runway

condition and slope, elevation, aircraft weight, wind, and temperature), typical takeoff acceleration should allow the airplane to reach 70 percent of lift-off airspeed by the midpoint of the runway. The “rule of thumb” is that should airplane acceleration not allow the airspeed to reach this value by the midpoint, the takeoff should be aborted, as it may not be possible to liftoff in the remaining runway.

Several points are important when considering using this “rule of thumb”:

a. Airspeed indicators in small airplanes are not required to be evaluated at speeds below stalling, and may not be usable at 70 percent of liftoff airspeed.

b. This “rule of thumb” is based on a uniform surface condition. Puddles, soft spots, areas of tall and/or wet grass, loose gravel, etc., may impede acceleration or even cause deceleration. Even if the airplane achieves 70 percent of liftoff airspeed by the midpoint, the condition of the remainder of the runway may not allow further acceleration. The entire length of the runway should be inspected prior to takeoff to ensure a usable surface.

c. This “rule of thumb” applies only to runway required for actual liftoff. In the event that obstacles affect the takeoff climb path, appropriate distance must be available after liftoff to accelerate to best angle of climb speed and to clear the obstacles. This will, in effect, require the airplane to accelerate to a higher speed by midpoint, particularly if the obstacles are close to the end of the runway. In addition, this technique does not take into account the effects of upslope or tailwinds on takeoff performance. These factors will also require greater acceleration than normal and, under some circumstances, prevent takeoff entirely.

d. Use of this “rule of thumb” does not alleviate the pilot’s responsibility to comply with applicable Federal Aviation Regulations, the limitations and performance data provided in the FAA approved Airplane Flight Manual (AFM), or, in the absence of an FAA approved AFM, other data provided by the aircraft manufacturer.

In addition to their use during takeoff, runway half-way signs offer the pilot increased awareness of his or her position along the runway during landing operations.

NOTE—

No FAA standard exists for the appearance of the runway half-way sign. FIG 7-5-1 shows a graphical depiction of a typical runway half-way sign.

7-5-8. Seaplane Safety

a. Acquiring a seaplane class rating affords access to many areas not available to landplane pilots. Adding a seaplane class rating to your pilot certificate can be relatively uncomplicated and inexpensive. However, more effort is required to become a safe, efficient, competent “bush” pilot. The natural hazards of the backwoods have given way to modern man-made hazards. Except for the far north, the available bodies of water are no longer the exclusive domain of the airman. Seaplane pilots must be vigilant for hazards such as electric power lines, power, sail and rowboats, rafts, mooring lines, water skiers, swimmers, etc.

FIG 7-5-1
Typical Runway Half-way Sign

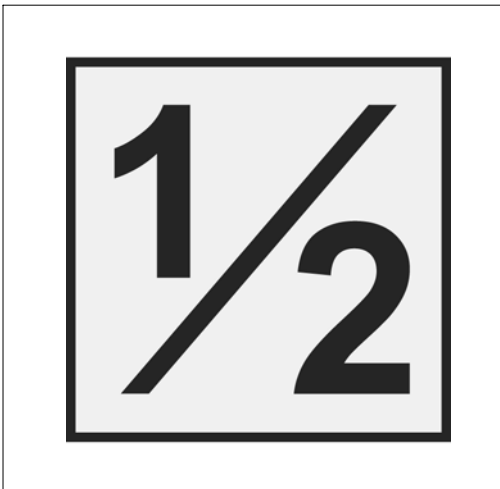

b. Seaplane pilots must have a thorough understanding of the right-of-way rules as they apply to aircraft versus other vessels. Seaplane pilots are expected to know and adhere to both the U.S. Coast Guard’s (USCG) Navigation Rules, International-Inland, and 14 CFR Section 91.115, Right-of-Way Rules; Water Operations. The navigation rules of the road are a set of collision avoidance rules as they apply to aircraft on the water. A seaplane is considered a vessel when on the water for the purposes of these collision avoidance rules. In general, a seaplane on the water must keep well clear

of all vessels and avoid impeding their navigation. The CFR requires, in part, that aircraft operating on the water “. . . shall, insofar as possible, keep clear of all vessels and avoid impeding their navigation, and shall give way to any vessel or other aircraft that is given the right-of-way” This means that a seaplane should avoid boats and commercial shipping when on the water. If on a collision course, the seaplane should slow, stop, or maneuver to the right, away from the bow of the oncoming vessel. Also, while on the surface with an engine running, an aircraft must give way to all nonpowered vessels. Since a seaplane in the water may not be as maneuverable as one in the air, the aircraft on the water has right-of-way over one in the air, and one taking off has right-of-way over one landing. A seaplane is exempt from the USCG safety equipment requirements, including the requirements for Personal Flotation Devices (PFD). Requiring seaplanes on the water to comply with USCG equipment requirements in addition to the FAA equipment requirements would be an unnecessary burden on seaplane owners and operators.

c. Unless they are under Federal jurisdiction, navigable bodies of water are under the jurisdiction of the state, or in a few cases, privately owned. Unless they are specifically restricted, aircraft have as much right to operate on these bodies of water as other vessels. To avoid problems, check with Federal or local officials in advance of operating on unfamiliar waters. In addition to the agencies listed in TBL 7-5-1, the nearest Flight Standards District Office can usually offer some practical suggestions as well as regulatory information. If you land on a restricted body of water because of an inflight emergency, or in ignorance of the restrictions you have violated, report as quickly as practical to the nearest local official having jurisdiction and explain your situation.

d. When operating a seaplane over or into remote areas, appropriate attention should be given to survival gear. Minimum kits are recommended for summer and winter, and are required by law for flight into sparsely settled areas of Canada and Alaska. Alaska State Department of Transportation and Canadian Ministry of Transport officials can provide specific information on survival gear requirements. The kit should be assembled in one container and be easily reachable and preferably floatable.

TBL 7-5-1

Jurisdictions Controlling Navigable Bodies of Water

Authority to Consult For Use of a Body of Water		
Location	Authority	Contact
Wilderness Area	U.S. Department of Agriculture, Forest Service	Local forest ranger
National Forest	USDA Forest Service	Local forest ranger
National Park	U.S. Department of the Interior, National Park Service	Local park ranger
Indian Reservation	USDI, Bureau of Indian Affairs	Local Bureau office
State Park	State government or state forestry or park service	Local state aviation office for further information
Canadian National and Provincial Parks	Supervised and restricted on an individual basis from province to province and by different departments of the Canadian government; consult Canadian Flight Information Manual and/or Water Aerodrome Supplement	Park Superintendent in an emergency

e. The FAA recommends that each seaplane owner or operator provide flotation gear for occupants any time a seaplane operates on or near water. 14 CFR Section 91.205(b)(12) requires approved flotation gear for aircraft operated for hire over water and beyond power-off gliding distance from shore. FAA-approved gear differs from that required for navigable waterways under USCG rules. FAA-approved life vests are inflatable designs as compared to the USCG’s noninflatable PFD’s that may consist of solid, bulky material. Such USCG PFDs are impractical for seaplanes and other aircraft because they may block passage through the relatively narrow exits available to pilots and passengers. Life vests approved under Technical Standard Order (TSO) TSO-C13E contain fully inflatable compartments. The wearer inflates the compartments (AFTER exiting the aircraft) primarily by independent CO2 cartridges, with an oral inflation tube as a backup. The flotation gear also contains a water-activated, self-illuminating signal light. The fact that pilots and

passengers can easily don and wear inflatable life vests (when not inflated) provides maximum effectiveness and allows for unrestricted movement. It is imperative that passengers are briefed on the location and proper use of available PFDs prior to leaving the dock.

f. The FAA recommends that seaplane owners and operators obtain Advisory Circular (AC) 91-69, Seaplane Safety for 14 CFR Part 91 Operations, free from the U.S. Department of Transportation, Subsequent Distribution Office, SVC-121.23, Ardmore East Business Center, 3341 Q 75th Avenue, Landover, MD 20785; fax: (301) 386-5394. The USCG Navigation Rules International-Inland (COMDTINSTM 16672.2B) is available for a fee from the Government Publishing Office by facsimile request to (202) 512-2250, and can be ordered using Mastercard or Visa.

7-5-9. Flight Operations in Volcanic Ash

a. Severe volcanic eruptions which send ash and sulphur dioxide (SO₂) gas into the upper atmosphere occur somewhere around the world several times each year. Flying into a volcanic ash cloud can be exceedingly dangerous. A B747-200 lost all four engines after such an encounter and a B747-400 had the same nearly catastrophic experience. Piston-powered aircraft are less likely to lose power but severe damage is almost certain to ensue after an encounter with a volcanic ash cloud which is only a few hours old.

b. Most important is to avoid any encounter with volcanic ash. The ash plume may not be visible, especially in instrument conditions or at night; and even if visible, it is difficult to distinguish visually between an ash cloud and an ordinary weather cloud. Volcanic ash clouds are not displayed on airborne or ATC radar. The pilot must rely on reports from air traffic controllers and other pilots to determine the location of the ash cloud and use that information to remain well clear of the area. Additionally, the presence of a sulphur-like odor throughout the cabin may indicate the presence of SO₂ emitted by volcanic activity, but may or may not indicate the presence of volcanic ash. Every attempt should be made to remain on the upwind side of the volcano.

c. It is recommended that pilots encountering an ash cloud should immediately reduce thrust to idle (altitude permitting), and reverse course in order to

escape from the cloud. Ash clouds may extend for hundreds of miles and pilots should not attempt to fly through or climb out of the cloud. In addition, the following procedures are recommended:

1. Disengage the autothrottle if engaged. This will prevent the autothrottle from increasing engine thrust;

2. Turn on continuous ignition;

3. Turn on all accessory airbleeds including all air conditioning packs, nacelles, and wing anti-ice. This will provide an additional engine stall margin by reducing engine pressure.

d. The following has been reported by flightcrews who have experienced encounters with volcanic dust clouds:

1. Smoke or dust appearing in the cockpit.

2. An acrid odor similar to electrical smoke.

3. Multiple engine malfunctions, such as compressor stalls, increasing EGT, torching from tailpipe, and flameouts.

4. At night, St. Elmo's fire or other static discharges accompanied by a bright orange glow in the engine inlets.

5. A fire warning in the forward cargo area.

e. It may become necessary to shut down and then restart engines to prevent exceeding EGT limits. Volcanic ash may block the pitot system and result in unreliable airspeed indications.

f. If you see a volcanic eruption and have not been previously notified of it, you may have been the first person to observe it. In this case, immediately contact ATC and alert them to the existence of the eruption. If possible, use the Volcanic Activity Reporting form (VAR) depicted in Appendix 2 of this manual. Items 1 through 8 of the VAR should be transmitted immediately. The information requested in items 9 through 16 should be passed after landing. If a VAR form is not immediately available, relay enough information to identify the position and nature of the volcanic activity. Do not become unnecessarily alarmed if there is merely steam or very low-level eruptions of ash.

g. When landing at airports where volcanic ash has been deposited on the runway, be aware that even a thin layer of dry ash can be detrimental to braking

action. Wet ash on the runway may also reduce effectiveness of braking. It is recommended that reverse thrust be limited to minimum practical to reduce the possibility of reduced visibility and engine ingestion of airborne ash.

h. When departing from airports where volcanic ash has been deposited, it is recommended that pilots avoid operating in visible airborne ash. Allow ash to settle before initiating takeoff roll. It is also recommended that flap extension be delayed until initiating the before takeoff checklist and that a rolling takeoff be executed to avoid blowing ash back into the air.

7-5-10. Emergency Airborne Inspection of Other Aircraft

a. Providing airborne assistance to another aircraft may involve flying in very close proximity to that aircraft. Most pilots receive little, if any, formal training or instruction in this type of flying activity. Close proximity flying without sufficient time to plan (i.e., in an emergency situation), coupled with the stress involved in a perceived emergency can be hazardous.

b. The pilot in the best position to assess the situation should take the responsibility of coordinating the airborne intercept and inspection, and take into account the unique flight characteristics and differences of the category(s) of aircraft involved.

c. Some of the safety considerations are:

1. Area, direction and speed of the intercept;

2. Aerodynamic effects (i.e., rotorcraft downwash);

3. Minimum safe separation distances;

4. Communications requirements, lost communications procedures, coordination with ATC;

5. Suitability of diverting the distressed aircraft to the nearest safe airport; and

6. Emergency actions to terminate the intercept.

d. Close proximity, inflight inspection of another aircraft is uniquely hazardous. The pilot-in-command of the aircraft experiencing the problem/emergency must not relinquish control of the situation and/or jeopardize the safety of their aircraft. The maneuver must be accomplished with minimum risk to both aircraft.

7-5-11. Precipitation Static

a. Precipitation static is caused by aircraft in flight coming in contact with uncharged particles. These particles can be rain, snow, fog, sleet, hail, volcanic ash, dust; any solid or liquid particles. When the aircraft strikes these neutral particles the positive element of the particle is reflected away from the aircraft and the negative particle adheres to the skin of the aircraft. In a very short period of time a substantial negative charge will develop on the skin of the aircraft. If the aircraft is not equipped with static dischargers, or has an ineffective static discharger system, when a sufficient negative voltage level is reached, the aircraft may go into "CORONA." That is, it will discharge the static electricity from the extremities of the aircraft, such as the wing tips, horizontal stabilizer, vertical stabilizer, antenna, propeller tips, etc. This discharge of static electricity is what you will hear in your headphones and is what we call P-static.

b. A review of pilot reports often shows different symptoms with each problem that is encountered. The following list of problems is a summary of many pilot reports from many different aircraft. Each problem was caused by P-static:

1. Complete loss of VHF communications.
2. Erroneous magnetic compass readings (30 percent in error).
3. High pitched squeal on audio.
4. Motor boat sound on audio.
5. Loss of all avionics in clouds.
6. VLF navigation system inoperative most of the time.
7. Erratic instrument readouts.
8. Weak transmissions and poor receptivity of radios.
9. "St. Elmo's Fire" on windshield.

c. Each of these symptoms is caused by one general problem on the airframe. This problem is the inability of the accumulated charge to flow easily to the wing tips and tail of the airframe, and properly discharge to the airstream.

d. Static dischargers work on the principal of creating a relatively easy path for discharging negative charges that develop on the aircraft by using a discharger with fine metal points, carbon coated rods, or carbon wicks rather than wait until a large charge is developed and discharged off the trailing edges of the aircraft that will interfere with avionics equipment. This process offers approximately 50 decibels (dB) static noise reduction which is adequate in most cases to be below the threshold of noise that would cause interference in avionics equipment.

e. It is important to remember that precipitation static problems can only be corrected with the proper number of quality static dischargers, properly installed on a properly bonded aircraft. P-static is indeed a problem in the all weather operation of the aircraft, but there are effective ways to combat it. All possible methods of reducing the effects of P-static should be considered so as to provide the best possible performance in the flight environment.

f. A wide variety of discharger designs is available on the commercial market. The inclusion of well-designed dischargers may be expected to improve airframe noise in P-static conditions by as much as 50 dB. Essentially, the discharger provides a path by which accumulated charge may leave the airframe quietly. This is generally accomplished by providing a group of tiny corona points to permit onset of corona-current flow at a low aircraft potential. Additionally, aerodynamic design of dischargers to permit corona to occur at the lowest possible atmospheric pressure also lowers the corona threshold. In addition to permitting a low-potential discharge, the discharger will minimize the radiation of radio frequency (RF) energy which accompanies the corona discharge, in order to minimize effects of RF components at communications and navigation frequencies on avionics performance. These effects are reduced through resistive attachment of the corona point(s) to the airframe, preserving direct current connection but attenuating the higher-frequency components of the discharge.

g. Each manufacturer of static dischargers offers information concerning appropriate discharger location on specific airframes. Such locations emphasize the trailing outboard surfaces of wings and horizontal tail surfaces, plus the tip of the vertical stabilizer, where charge tends to accumulate on the airframe.

Sufficient dischargers must be provided to allow for current-carrying capacity which will maintain airframe potential below the corona threshold of the trailing edges.

h. In order to achieve full performance of avionic equipment, the static discharge system will require periodic maintenance. A pilot knowledgeable of P-static causes and effects is an important element in assuring optimum performance by early recognition of these types of problems.

7-5-12. Light Amplification by Stimulated Emission of Radiation (Laser) Operations and Reporting Illumination of Aircraft

a. Lasers have many applications. Of concern to users of the National Airspace System are those laser events that may affect pilots, e.g., outdoor laser light shows or demonstrations for entertainment and advertisements at special events and theme parks. Generally, the beams from these events appear as bright blue-green in color; however, they may be red, yellow, or white. However, some laser systems produce light which is invisible to the human eye.

b. FAA regulations prohibit the disruption of aviation activity by any person on the ground or in the air. The FAA and the Food and Drug Administration (the Federal agency that has the responsibility to enforce compliance with Federal requirements for laser systems and laser light show products) are working together to ensure that operators of these devices do not pose a hazard to aircraft operators.

c. Pilots should be aware that illumination from these laser operations are able to create temporary vision impairment miles from the actual location. In addition, these operations can produce permanent eye damage. Pilots should make themselves aware of where these activities are being conducted and avoid these areas if possible.

d. Recent and increasing incidents of unauthorized illumination of aircraft by lasers, as well as the proliferation and increasing sophistication of laser devices available to the general public, dictates that the FAA, in coordination with other government agencies, take action to safeguard flights from these unauthorized illuminations.

e. Pilots should report laser illumination activity to the controlling Air Traffic Control facilities, Federal Contract Towers or Flight Service Stations as soon as possible after the event. The following information should be included:

1. UTC Date and Time of Event.
2. Call Sign or Aircraft Registration Number.
3. Type Aircraft.
4. Nearest Major City.
5. Altitude.

6. Location of Event (Latitude/Longitude and/or Fixed Radial Distance (FRD)).

7. Brief Description of the Event and any other Pertinent Information.

f. Pilots are also encouraged to complete the Laser Beam Exposure Questionnaire located on the FAA Laser Safety Initiative website at <http://www.faa.gov/about/initiatives/lasers/> and submit electronically per the directions on the questionnaire, as soon as possible after landing.

g. When a laser event is reported to an air traffic facility, a general caution warning will be broadcasted on all appropriate frequencies every five minutes for 20 minutes and broadcasted on the ATIS for one hour following the report.

PHRASEOLOGY-

UNAUTHORIZED LASER ILLUMINATION EVENT, (UTC time), (location), (altitude), (color), (direction).

EXAMPLE-

“Unauthorized laser illumination event, at 0100z, 8 mile final runway 18R at 3,000 feet, green laser from the southwest.”

REFERENCE-

FAA Order JO 7110.65, Paragraph 10-2-14, Unauthorized Laser Illumination of Aircraft

FAA Order JO 7210.3, Paragraph 2-1-27, Reporting Unauthorized Laser Illumination of Aircraft

h. When these activities become known to the FAA, Notices to Airmen (NOTAMs) are issued to inform the aviation community of the events. Pilots should consult NOTAMs or the Special Notices section of the Chart Supplement U.S. for information regarding these activities.

7-5-13. Flying in Flat Light, Brown Out Conditions, and White Out Conditions

a. Flat Light. Flat light is an optical illusion, also known as “**sector or partial white out.**” It is not as severe as “white out” but the condition causes pilots to lose their depth-of-field and contrast in vision. Flat light conditions are usually accompanied by overcast skies inhibiting any visual clues. Such conditions can occur anywhere in the world, primarily in snow covered areas but can occur in dust, sand, mud flats, or on glassy water. Flat light can completely obscure features of the terrain, creating an inability to distinguish distances and closure rates. As a result of this reflected light, it can give pilots the illusion that they are ascending or descending when they may actually be flying level. However, with good judgment and proper training and planning, it is possible to safely operate an aircraft in flat light conditions.

b. Brown Out. A brownout (or *brown-out*) is an in-flight visibility restriction due to dust or sand in the air. In a brownout, the pilot cannot see nearby objects which provide the outside visual references necessary to control the aircraft near the ground. This can cause spatial disorientation and loss of situational awareness leading to an accident.

1. The following factors will affect the probability and severity of brownout: rotor disk loading, rotor configuration, soil composition, wind, approach speed, and approach angle.

2. The brownout phenomenon causes accidents during helicopter landing and take-off operations in dust, fine dirt, sand, or arid desert terrain. Intense, blinding dust clouds stirred up by the helicopter rotor downwash during near-ground flight causes significant flight safety risks from aircraft and ground obstacle collisions, and dynamic rollover due to sloped and uneven terrain.

3. This is a dangerous phenomenon experienced by many helicopters when making landing approaches in dusty environments, whereby sand or dust particles become swept up in the rotor outwash and obscure the pilot’s vision of the terrain. This is particularly dangerous because the pilot needs those visual cues from their surroundings in order to make a safe landing.

4. Blowing sand and dust can cause an illusion of a tilted horizon. A pilot not using the flight

instruments for reference may instinctively try to level the aircraft with respect to the false horizon, resulting in an accident. Helicopter rotor wash also causes sand to blow around outside the cockpit windows, possibly leading the pilot to experience an illusion where the helicopter appears to be turning when it is actually in a level hover. This can also cause the pilot to make incorrect control inputs which can quickly lead to disaster when hovering near the ground. In night landings, aircraft lighting can enhance the visual illusions by illuminating the brownout cloud.

c. White Out. As defined in meteorological terms, white out occurs when a person becomes engulfed in a uniformly white glow. The glow is a result of being surrounded by blowing snow, dust, sand, mud or water. There are no shadows, no horizon or clouds and all depth-of-field and orientation are lost. A white out situation is severe in that there are no visual references. Flying is not recommended in any white out situation. Flat light conditions can lead to a white out environment quite rapidly, and both atmospheric conditions are insidious; they sneak up on you as your visual references slowly begin to disappear. White out has been the cause of several aviation accidents.

d. Self Induced White Out. This effect typically occurs when a helicopter takes off or lands on a snow-covered area. The rotor down wash picks up particles and re-circulates them through the rotor down wash. The effect can vary in intensity depending upon the amount of light on the surface. This can happen on the sunniest, brightest day with good contrast everywhere. However, when it happens, there can be a complete loss of visual clues. If the pilot has not prepared for this immediate loss of visibility, the results can be disastrous. Good planning does not prevent one from encountering flat light or white out conditions.

e. Never take off in a white out situation.

1. Realize that in flat light conditions it may be possible to depart but not to return to that site. During takeoff, make sure you have a reference point. Do not lose sight of it until you have a departure reference point in view. Be prepared to return to the takeoff reference if the departure reference does not come into view.

2. Flat light is common to snow skiers. One way to compensate for the lack of visual contrast and

depth-of-field loss is by wearing amber tinted lenses (also known as blue blockers). Special note of caution: Eyewear is not ideal for every pilot. Take into consideration personal factors – age, light sensitivity, and ambient lighting conditions.

3. So what should a pilot do when all visual references are lost?

(a) Trust the cockpit instruments.

(b) Execute a 180 degree turnaround and start looking for outside references.

(c) Above all – fly the aircraft.

f. Landing in Low Light Conditions. When landing in a low light condition – use extreme caution. Look for intermediate reference points, in addition to checkpoints along each leg of the route for course confirmation and timing. The lower the ambient light becomes, the more reference points a pilot should use.

g. Airport Landings.

1. Look for features around the airport or approach path that can be used in determining depth perception. Buildings, towers, vehicles or other aircraft serve well for this measurement. Use something that will provide you with a sense of height above the ground, in addition to orienting you to the runway.

2. Be cautious of snowdrifts and snow banks – anything that can distinguish the edge of the runway. Look for subtle changes in snow texture or shading to identify ridges or changes in snow depth.

h. Off-Airport Landings.

1. In the event of an off-airport landing, pilots have used a number of different visual cues to gain reference. Use whatever you must to create the contrast you need. Natural references seem to work best (trees, rocks, snow ribs, etc.)

(a) Over flight.

(b) Use of markers.

(c) Weighted flags.

(d) Smoke bombs.

(e) Any colored rags.

(f) Dye markers.

(g) Kool-aid.

(h) Trees or tree branches.

2. It is difficult to determine the depth of snow in areas that are level. Dropping items from the aircraft to use as reference points should be used as a visual aid only and not as a primary landing reference. Unless your marker is biodegradable, be sure to retrieve it after landing. Never put yourself in a position where no visual references exist.

3. Abort landing if blowing snow obscures your reference. Make your decisions early. Don't assume you can pick up a lost reference point when you get closer.

4. Exercise extreme caution when flying from sunlight into shade. Physical awareness may tell you that you are flying straight but you may actually be in a spiral dive with centrifugal force pressing against you. Having no visual references enhances this illusion. Just because you have a good visual reference does not mean that it's safe to continue. There may be snow-covered terrain not visible in the direction that you are traveling. Getting caught in a no visual reference situation can be fatal.

i. Flying Around a Lake.

1. When flying along lakeshores, use them as a reference point. Even if you can see the other side, realize that your depth perception may be poor. It is easy to fly into the surface. If you must cross the lake, check the altimeter frequently and maintain a safe altitude while you still have a good reference. Don't descend below that altitude.

2. The same rules apply to seemingly flat areas of snow. If you don't have good references, avoid going there.

j. Other Traffic. Be on the look out for other traffic in the area. Other aircraft may be using your same reference point. Chances are greater of colliding with someone traveling in the same direction as you, than someone flying in the opposite direction.

k. Ceilings. Low ceilings have caught many pilots off guard. Clouds do not always form parallel to the surface, or at the same altitude. Pilots may try to compensate for this by flying with a slight bank and thus creating a descending turn.

1. Glaciers. Be conscious of your altitude when flying over glaciers. The glaciers may be rising faster than you are climbing.

7–5–14. Operations in Ground Icing Conditions

a. The presence of aircraft airframe icing during takeoff, typically caused by improper or no deicing of the aircraft being accomplished prior to flight has contributed to many recent accidents in turbine aircraft. The General Aviation Joint Steering Committee (GAJSC) is the primary vehicle for government–industry cooperation, communication, and coordination on GA accident mitigation. The Turbine Aircraft Operations Subgroup (TAOS) works to mitigate accidents in turbine accident aviation. While there is sufficient information and guidance currently available regarding the effects of icing on aircraft and methods for deicing, the TAOS has developed a list of recommended actions to further assist pilots and operators in this area.

While the efforts of the TAOS specifically focus on turbine aircraft, it is recognized that their recommendations are applicable to and can be adapted for the pilot of a small, piston powered aircraft too.

b. The following recommendations are offered:

1. Ensure that your aircraft’s lift–generating surfaces are COMPLETELY free of contamination before flight through a tactile (hands on) check of the critical surfaces when feasible. Even when otherwise permitted, operators should avoid smooth or polished frost on lift–generating surfaces as an acceptable preflight condition.

2. Review and refresh your cold weather standard operating procedures.

3. Review and be familiar with the Airplane Flight Manual (AFM) limitations and procedures necessary to deal with icing conditions prior to flight, as well as in flight.

4. Protect your aircraft while on the ground, if possible, from sleet and freezing rain by taking advantage of aircraft hangars.

5. Take full advantage of the opportunities available at airports for deicing. Do not refuse deicing services simply because of cost.

6. Always consider canceling or delaying a flight if weather conditions do not support a safe operation.

c. If you haven’t already developed a set of Standard Operating Procedures for cold weather operations, they should include:

1. Procedures based on information that is applicable to the aircraft operated, such as AFM limitations and procedures;

2. Concise and easy to understand guidance that outlines best operational practices;

3. A systematic procedure for recognizing, evaluating and addressing the associated icing risk, and offer clear guidance to mitigate this risk;

4. An aid (such as a checklist or reference cards) that is readily available during normal day–to–day aircraft operations.

d. There are several sources for guidance relating to airframe icing, including:

1. <http://aircrafticing.grc.nasa.gov/index.html>

2. <http://www.ibac.org/is-bao/isbao.htm>

3. http://www.natasafety1st.org/bus_deice.htm

4. Advisory Circular (AC) 91–74, Pilot Guide, Flight in Icing Conditions.

5. AC 135–17, Pilot Guide Small Aircraft Ground Deicing.

6. AC 135–9, FAR Part 135 Icing Limitations.

7. AC 120–60, Ground Deicing and Anti–icing Program.

8. AC 135–16, Ground Deicing and Anti–icing Training and Checking.

The FAA Approved Deicing Program Updates is published annually as a Flight Standards Information Bulletin for Air Transportation and contains detailed information on deicing and anti–icing procedures and holdover times. It may be accessed at the following website by selecting the current year’s information bulletins:

http://www.faa.gov/library/manuals/examiners_inspectors/8400/fsat

7-5-15. Avoid Flight in the Vicinity of Exhaust Plumes (Smoke Stacks and Cooling Towers)

a. Flight Hazards Exist Around Exhaust Plumes. Exhaust plumes are defined as visible or invisible emissions from power plants, industrial production facilities, or other industrial systems that release large amounts of vertically directed unstable gases (effluent). High temperature exhaust plumes can cause significant air disturbances such as turbulence and vertical shear. Other identified potential hazards include, but are not necessarily limited to: reduced visibility, oxygen depletion, engine particulate contamination, exposure to gaseous oxides, and/or icing. Results of encountering a plume may include airframe damage, aircraft upset, and/or engine damage/failure. These hazards are most critical during low altitude flight in calm and cold air, especially in and around approach and departure corridors or airport traffic areas.

Whether plumes are visible or invisible, the total extent of their turbulent affect is difficult to predict. Some studies do predict that the significant turbulent effects of an exhaust plume can extend to heights of over 1,000 feet above the height of the top of the stack or cooling tower. Any effects will be more pronounced in calm stable air where the plume is very hot and the surrounding area is still and cold. Fortunately, studies also predict that any amount of crosswind will help to dissipate the effects. However, the size of the tower or stack is not a good indicator of the predicted effect the plume may produce. The major effects are related to the heat or size of the

plume effluent, the ambient air temperature, and the wind speed affecting the plume. Smaller aircraft can expect to feel an effect at a higher altitude than heavier aircraft.

b. When able, a pilot should steer clear of exhaust plumes by flying on the upwind side of smokestacks or cooling towers. When a plume is visible via smoke or a condensation cloud, remain clear and realize a plume may have both visible and invisible characteristics. Exhaust stacks without visible plumes may still be in full operation, and airspace in the vicinity should be treated with caution. As with mountain wave turbulence or clear air turbulence, an invisible plume may be encountered unexpectedly. Cooling towers, power plant stacks, exhaust fans, and other similar structures are depicted in FIG 7-5-2.

Pilots are encouraged to exercise caution when flying in the vicinity of exhaust plumes. Pilots are also encouraged to reference the Chart Supplement U.S. where amplifying notes may caution pilots and identify the location of structure(s) emitting exhaust plumes.

The best available information on this phenomenon must come from pilots via the PIREP reporting procedures. All pilots encountering hazardous plume conditions are urgently requested to report time, location, and intensity (light, moderate, severe, or extreme) of the element to the FAA facility with which they are maintaining radio contact. If time and conditions permit, elements should be reported according to the standards for other PIREPs and position reports (AIM Paragraph 7-1-23, PIREPS Relating to Turbulence).

**FIG 7-5-2
Plumes**

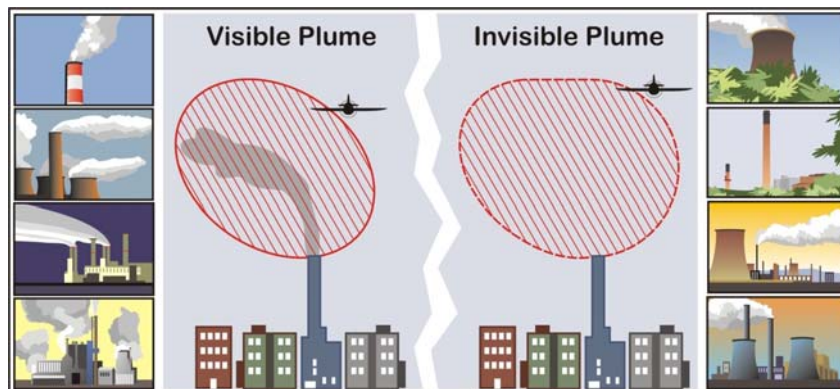

Section 6. Safety, Accident, and Hazard Reports

7-6-1. Aviation Safety Reporting Program

a. The FAA has established a voluntary Aviation Safety Reporting Program designed to stimulate the free and unrestricted flow of information concerning deficiencies and discrepancies in the aviation system. This is a positive program intended to ensure the safest possible system by identifying and correcting unsafe conditions before they lead to accidents. The primary objective of the program is to obtain information to evaluate and enhance the safety and efficiency of the present system.

b. This cooperative safety reporting program invites pilots, controllers, flight attendants, maintenance personnel and other users of the airspace system, or any other person, to file written reports of actual or potential discrepancies and deficiencies involving the safety of aviation operations. The operations covered by the program include departure, en route, approach, and landing operations and procedures, air traffic control procedures and equipment, crew and air traffic control communications, aircraft cabin operations, aircraft movement on the airport, near midair collisions, aircraft maintenance and record keeping and airport conditions or services.

c. The report should give the date, time, location, persons and aircraft involved (if applicable), nature of the event, and all pertinent details.

d. To ensure receipt of this information, the program provides for the waiver of certain disciplinary actions against persons, including pilots and air traffic controllers, who file timely written reports concerning potentially unsafe incidents. To be considered timely, reports must be delivered or postmarked within 10 days of the incident unless that period is extended for good cause. Reports should be submitted on NASA ARC Forms 277, which are available free of charge, postage prepaid, at FAA Flight Standards District Offices and Flight Service Stations, and from NASA, ASRS, PO Box 189, Moffet Field, CA 94035.

e. The FAA utilizes the National Aeronautics and Space Administration (NASA) to act as an independent third party to receive and analyze reports submitted under the program. This program is

described in AC 00-46, Aviation Safety Reporting Program.

7-6-2. Aircraft Accident and Incident Reporting

a. Occurrences Requiring Notification. The operator of an aircraft must immediately, and by the most expeditious means available, notify the nearest National Transportation Safety Board (NTSB) Field Office when:

1. An aircraft accident or any of the following listed incidents occur:

(a) Flight control system malfunction or failure.

(b) Inability of any required flight crew member to perform their normal flight duties as a result of injury or illness.

(c) Failure of structural components of a turbine engine excluding compressor and turbine blades and vanes.

(d) Inflight fire.

(e) Aircraft collide in flight.

(f) Damage to property, other than the aircraft, estimated to exceed \$25,000 for repair (including materials and labor) or fair market value in the event of total loss, whichever is less.

(g) For large multi-engine aircraft (more than 12,500 pounds maximum certificated takeoff weight):

(1) Inflight failure of electrical systems which requires the sustained use of an emergency bus powered by a back-up source such as a battery, auxiliary power unit, or air-driven generator to retain flight control or essential instruments;

(2) Inflight failure of hydraulic systems that results in sustained reliance on the sole remaining hydraulic or mechanical system for movement of flight control surfaces;

(3) Sustained loss of the power or thrust produced by two or more engines; and

(4) An evacuation of aircraft in which an emergency egress system is utilized.

2. An aircraft is overdue and is believed to have been involved in an accident.

b. Manner of Notification.

1. The most expeditious method of notification to the NTSB by the operator will be determined by the circumstances existing at that time. The NTSB has advised that any of the following would be considered examples of the type of notification that would be acceptable:

(a) Direct telephone notification.

(b) Telegraphic notification.

(c) Notification to the FAA who would in turn notify the NTSB by direct communication; i.e., dispatch or telephone.

c. Items to be Included in Notification. The notification required above must contain the following information, if available:

1. Type, nationality, and registration marks of the aircraft.

2. Name of owner and operator of the aircraft.

3. Name of the pilot-in-command.

4. Date and time of the accident, or incident.

5. Last point of departure, and point of intended landing of the aircraft.

6. Position of the aircraft with reference to some easily defined geographical point.

7. Number of persons aboard, number killed, and number seriously injured.

8. Nature of the accident, or incident, the weather, and the extent of damage to the aircraft so far as is known; and

9. A description of any explosives, radioactive materials, or other dangerous articles carried.

d. Follow-up Reports.

1. The operator must file a report on NTSB Form 6120.1 or 6120.2, available from NTSB Field Offices or from the NTSB, Washington, DC, 20594:

(a) Within 10 days after an accident;

(b) When, after 7 days, an overdue aircraft is still missing;

(c) A report on an incident for which notification is required as described in subparagraph a(1) must be filed only as requested by an authorized representative of the NTSB.

2. Each crewmember, if physically able at the time the report is submitted, must attach a statement setting forth the facts, conditions, and circumstances relating to the accident or incident as they appeared. If the crewmember is incapacitated, a statement must be submitted as soon as physically possible.

e. Where to File the Reports.

1. The operator of an aircraft must file with the NTSB Field Office nearest the accident or incident any report required by this section.

2. The NTSB Field Offices are listed under U.S. Government in the telephone directories in the following cities: Anchorage, AK; Atlanta, GA; Chicago, IL; Denver, CO; Fort Worth, TX; Los Angeles, CA; Miami, FL; Parsippany, NJ; Seattle, WA.

7-6-3. Near Midair Collision Reporting

a. Purpose and Data Uses. The primary purpose of the Near Midair Collision (NMAC) Reporting Program is to provide information for use in enhancing the safety and efficiency of the National Airspace System. Data obtained from NMAC reports are used by the FAA to improve the quality of FAA services to users and to develop programs, policies, and procedures aimed at the reduction of NMAC occurrences. All NMAC reports are thoroughly investigated by Flight Standards Facilities in coordination with Air Traffic Facilities. Data from these investigations are transmitted to FAA Headquarters in Washington, DC, where they are compiled and analyzed, and where safety programs and recommendations are developed.

b. Definition. A near midair collision is defined as an incident associated with the operation of an aircraft in which a possibility of collision occurs as a result of proximity of less than 500 feet to another aircraft, or a report is received from a pilot or a flight crew member stating that a collision hazard existed between two or more aircraft.

c. Reporting Responsibility. It is the responsibility of the pilot and/or flight crew to determine whether a near midair collision did actually occur and, if so, to initiate a NMAC report. Be specific, as

ATC will not interpret a casual remark to mean that a NMAC is being reported. The pilot should state “I wish to report a near midair collision.”

d. Where to File Reports. Pilots and/or flight crew members involved in NMAC occurrences are urged to report each incident immediately:

1. By radio or telephone to the nearest FAA ATC facility or FSS.

2. In writing, in lieu of the above, to the nearest Flight Standards District Office (FSDO).

e. Items to be Reported.

1. Date and time (UTC) of incident.

2. Location of incident and altitude.

3. Identification and type of reporting aircraft, aircrew destination, name and home base of pilot.

4. Identification and type of other aircraft, aircrew destination, name and home base of pilot.

5. Type of flight plans; station altimeter setting used.

6. Detailed weather conditions at altitude or flight level.

7. Approximate courses of both aircraft: indicate if one or both aircraft were climbing or descending.

8. Reported separation in distance at first sighting, proximity at closest point horizontally and vertically, and length of time in sight prior to evasive action.

9. Degree of evasive action taken, if any (from both aircraft, if possible).

10. Injuries, if any.

f. Investigation. The FSDO in whose area the incident occurred is responsible for the investigation and reporting of NMACs.

g. Existing radar, communication, and weather data will be examined in the conduct of the investigation. When possible, all cockpit crew members will be interviewed regarding factors involving the NMAC incident. Air traffic controllers will be interviewed in cases where one or more of the

involved aircraft was provided ATC service. Both flight and ATC procedures will be evaluated. When the investigation reveals a violation of an FAA regulation, enforcement action will be pursued.

7-6-4. Unidentified Flying Object (UFO) Reports

a. Persons wanting to report UFO/unexplained phenomena activity should contact a UFO/unexplained phenomena reporting data collection center, such as the National UFO Reporting Center, etc.

b. If concern is expressed that life or property might be endangered, report the activity to the local law enforcement department.

7-6-5. Safety Alerts For Operators (SAFO) and Information For Operators (InFO)

a. SAFOs contain important safety information that is often time-critical. A SAFO may contain information and/or recommended (non-regulatory) action to be taken by the respective operators or parties identified in the SAFO. The audience for SAFOs varies with each subject and may include: Air carrier certificate holders, air operator certificate holders, general aviation operators, directors of safety, directors of operations, directors of maintenance, fractional ownership program managers, training center managers, accountable managers at repair stations, and other parties as applicable.

b. InFOs are similar to SAFOs, but contain valuable information for operators that should help them meet administrative requirements or certain regulatory requirements with relatively low urgency or impact in safety.

c. The SAFO and InFO system provides a means to rapidly distribute this information to operators and can be found at the following website:

http://www.faa.gov/other_visit/aviation_industry/airline_operators/airline_safety/safo and

http://www.faa.gov/other_visit/aviation_industry/airline_operators/airline_safety/info

or search keyword FAA SAFO or FAA INFO. Free electronic subscription is available on the “ALL SAFOs” or “ALL InFOs” page of the website.

Chapter 8. Medical Facts for Pilots

Section 1. Fitness for Flight

8-1-1. Fitness For Flight

a. Medical Certification.

1. All pilots except those flying gliders and free air balloons must possess valid medical certificates in order to exercise the privileges of their airman certificates. The periodic medical examinations required for medical certification are conducted by designated Aviation Medical Examiners, who are physicians with a special interest in aviation safety and training in aviation medicine.

2. The standards for medical certification are contained in 14 CFR Part 67. Pilots who have a history of certain medical conditions described in these standards are mandatorily disqualified from flying. These medical conditions include a personality disorder manifested by overt acts, a psychosis, alcoholism, drug dependence, epilepsy, an unexplained disturbance of consciousness, myocardial infarction, angina pectoris and diabetes requiring medication for its control. Other medical conditions may be temporarily disqualifying, such as acute infections, anemia, and peptic ulcer. Pilots who do not meet medical standards may still be qualified under special issuance provisions or the exemption process. This may require that either additional medical information be provided or practical flight tests be conducted.

3. Student pilots should visit an Aviation Medical Examiner as soon as possible in their flight training in order to avoid unnecessary training expenses should they not meet the medical standards. For the same reason, the student pilot who plans to enter commercial aviation should apply for the highest class of medical certificate that might be necessary in the pilot's career.

CAUTION-

The CFRs prohibit a pilot who possesses a current medical certificate from performing crewmember duties while the pilot has a known medical condition or increase of a known medical condition that would make the pilot unable to meet the standards for the medical certificate.

b. Illness.

1. Even a minor illness suffered in day-to-day living can seriously degrade performance of many piloting tasks vital to safe flight. Illness can produce fever and distracting symptoms that can impair judgment, memory, alertness, and the ability to make calculations. Although symptoms from an illness may be under adequate control with a medication, the medication itself may decrease pilot performance.

2. The safest rule is not to fly while suffering from any illness. If this rule is considered too stringent for a particular illness, the pilot should contact an Aviation Medical Examiner for advice.

c. Medication.

1. Pilot performance can be seriously degraded by both prescribed and over-the-counter medications, as well as by the medical conditions for which they are taken. Many medications, such as tranquilizers, sedatives, strong pain relievers, and cough-suppressant preparations, have primary effects that may impair judgment, memory, alertness, coordination, vision, and the ability to make calculations. Others, such as antihistamines, blood pressure drugs, muscle relaxants, and agents to control diarrhea and motion sickness, have side effects that may impair the same critical functions. Any medication that depresses the nervous system, such as a sedative, tranquilizer or antihistamine, can make a pilot much more susceptible to hypoxia.

2. The CFRs prohibit pilots from performing crewmember duties while using any medication that affects the faculties in any way contrary to safety. The safest rule is not to fly as a crewmember while taking any medication, unless approved to do so by the FAA.

d. Alcohol.

1. Extensive research has provided a number of facts about the hazards of alcohol consumption and flying. As little as one ounce of liquor, one bottle of beer or four ounces of wine can impair flying skills, with the alcohol consumed in these drinks being detectable in the breath and blood for at least 3 hours. Even after the body completely destroys a moderate amount of alcohol, a pilot can still be severely

impaired for many hours by hangover. There is simply no way of increasing the destruction of alcohol or alleviating a hangover. Alcohol also renders a pilot much more susceptible to disorientation and hypoxia.

2. A consistently high alcohol related fatal aircraft accident rate serves to emphasize that alcohol and flying are a potentially lethal combination. The CFRs prohibit pilots from performing crewmember duties within 8 hours after drinking any alcoholic beverage or while under the influence of alcohol. However, due to the slow destruction of alcohol, a pilot may still be under influence 8 hours after drinking a moderate amount of alcohol. Therefore, an excellent rule is to allow at least 12 to 24 hours between “bottle and throttle,” depending on the amount of alcoholic beverage consumed.

e. Fatigue.

1. Fatigue continues to be one of the most treacherous hazards to flight safety, as it may not be apparent to a pilot until serious errors are made. Fatigue is best described as either acute (short-term) or chronic (long-term).

2. A normal occurrence of everyday living, acute fatigue is the tiredness felt after long periods of physical and mental strain, including strenuous muscular effort, immobility, heavy mental workload, strong emotional pressure, monotony, and lack of sleep. Consequently, coordination and alertness, so vital to safe pilot performance, can be reduced. Acute fatigue is prevented by adequate rest and sleep, as well as by regular exercise and proper nutrition.

3. Chronic fatigue occurs when there is not enough time for full recovery between episodes of acute fatigue. Performance continues to fall off, and judgment becomes impaired so that unwarranted risks may be taken. Recovery from chronic fatigue requires a prolonged period of rest.

4. **OBSTRUCTIVE SLEEP APNEA (OSA).** OSA is now recognized as an important preventable factor identified in transportation accidents. OSA interrupts the normal restorative sleep necessary for normal functioning and is associated with chronic illnesses such as hypertension, heart attack, stroke, obesity, and diabetes. Symptoms include snoring, excessive daytime sleepiness, intermittent prolonged breathing pauses while sleeping, memory impair-

ment and lack of concentration. There are many available treatments which can reverse the day time symptoms and reduce the chance of an accident. OSA can be easily treated. Most treatments are acceptable for medical certification upon demonstrating effective treatment. If you have any symptoms described above, or neck size over 17 inches in men or 16 inches in women, or a body mass index greater than 30 you should be evaluated for sleep apnea by a sleep medicine specialist.

(https://www.cdc.gov/healthyweight/assessing/bmi/adult_bmi/english_bmi_calculator/bmi_calculator.html) With treatment you can avoid or delay the onset of these chronic illnesses and prolong a quality life.

f. Stress.

1. Stress from the pressures of everyday living can impair pilot performance, often in very subtle ways. Difficulties, particularly at work, can occupy thought processes enough to markedly decrease alertness. Distraction can so interfere with judgment that unwarranted risks are taken, such as flying into deteriorating weather conditions to keep on schedule. Stress and fatigue (see above) can be an extremely hazardous combination.

2. Most pilots do not leave stress “on the ground.” Therefore, when more than usual difficulties are being experienced, a pilot should consider delaying flight until these difficulties are satisfactorily resolved.

g. Emotion.

Certain emotionally upsetting events, including a serious argument, death of a family member, separation or divorce, loss of job, and financial catastrophe, can render a pilot unable to fly an aircraft safely. The emotions of anger, depression, and anxiety from such events not only decrease alertness but also may lead to taking risks that border on self-destruction. Any pilot who experiences an emotionally upsetting event should not fly until satisfactorily recovered from it.

h. Personal Checklist. Aircraft accident statistics show that pilots should be conducting preflight checklists on themselves as well as their aircraft for pilot impairment contributes to many more accidents than failures of aircraft systems. A personal checklist, which includes all of the categories of pilot impairment as discussed in this section, that can be

easily committed to memory is being distributed by the FAA in the form of a wallet-sized card.

i. PERSONAL CHECKLIST. *I'm physically and mentally safe to fly; not being impaired by:*

Illness

Medication

Stress

Alcohol

Fatigue

Emotion

8-1-2. Effects of Altitude

a. Hypoxia.

1. Hypoxia is a state of oxygen deficiency in the body sufficient to impair functions of the brain and other organs. Hypoxia from exposure to altitude is due only to the reduced barometric pressures encountered at altitude, for the concentration of oxygen in the atmosphere remains about 21 percent from the ground out to space.

2. Although a deterioration in night vision occurs at a cabin pressure altitude as low as 5,000 feet, other significant effects of altitude hypoxia usually do not occur in the normal healthy pilot below 12,000 feet. From 12,000 to 15,000 feet of altitude, judgment, memory, alertness, coordination and ability to make calculations are impaired, and headache, drowsiness, dizziness and either a sense of well-being (euphoria) or belligerence occur. The effects appear following increasingly shorter periods of exposure to increasing altitude. In fact, pilot performance can seriously deteriorate within 15 minutes at 15,000 feet.

3. At cabin pressure altitudes above 15,000 feet, the periphery of the visual field grays out to a point where only central vision remains (tunnel vision). A blue coloration (cyanosis) of the fingernails and lips develops. The ability to take corrective and protective action is lost in 20 to 30 minutes at 18,000 feet and

5 to 12 minutes at 20,000 feet, followed soon thereafter by unconsciousness.

4. The altitude at which significant effects of hypoxia occur can be lowered by a number of factors. Carbon monoxide inhaled in smoking or from exhaust fumes, lowered hemoglobin (anemia), and certain medications can reduce the oxygen-carrying capacity of the blood to the degree that the amount of oxygen provided to body tissues will already be equivalent to the oxygen provided to the tissues when exposed to a cabin pressure altitude of several thousand feet. Small amounts of alcohol and low doses of certain drugs, such as antihistamines, tranquilizers, sedatives and analgesics can, through their depressant action, render the brain much more susceptible to hypoxia. Extreme heat and cold, fever, and anxiety increase the body's demand for oxygen, and hence its susceptibility to hypoxia.

5. The effects of hypoxia are usually quite difficult to recognize, especially when they occur gradually. Since symptoms of hypoxia do not vary in an individual, the ability to recognize hypoxia can be greatly improved by experiencing and witnessing the effects of hypoxia during an altitude chamber "flight." The FAA provides this opportunity through aviation physiology training, which is conducted at the FAA Civil Aeromedical Institute and at many military facilities across the U.S. To attend the Physiological Training Program at the Civil Aeromedical Institute, Mike Monroney Aeronautical Center, Oklahoma City, OK, contact by telephone (405) 954-6212, or by writing Aerospace Medical Education Division, AAM-400, CAMI, Mike Monroney Aeronautical Center, P.O. Box 25082, Oklahoma City, OK 73125.

NOTE-

To attend the physiological training program at one of the military installations having the training capability, an application form and a fee must be submitted. Full particulars about location, fees, scheduling procedures, course content, individual requirements, etc., are contained in the Physiological Training Application, Form Number AC 3150-7, which is obtained by contacting the accident prevention specialist or the office forms manager in the nearest FAA office.

6. Hypoxia is prevented by heeding factors that reduce tolerance to altitude, by enriching the inspired air with oxygen from an appropriate oxygen system, and by maintaining a comfortable, safe cabin pressure altitude. For optimum protection, pilots are encouraged to use supplemental oxygen above

10,000 feet during the day, and above 5,000 feet at night. The CFRs require that at the minimum, flight crew be provided with and use supplemental oxygen after 30 minutes of exposure to cabin pressure altitudes between 12,500 and 14,000 feet and immediately on exposure to cabin pressure altitudes above 14,000 feet. Every occupant of the aircraft must be provided with supplemental oxygen at cabin pressure altitudes above 15,000 feet.

b. Ear Block.

1. As the aircraft cabin pressure decreases during ascent, the expanding air in the middle ear pushes the eustachian tube open, and by escaping down it to the nasal passages, equalizes in pressure with the cabin pressure. But during descent, the pilot must periodically open the eustachian tube to equalize pressure. This can be accomplished by swallowing, yawning, tensing muscles in the throat, or if these do not work, by a combination of closing the mouth, pinching the nose closed, and attempting to blow through the nostrils (Valsalva maneuver).

2. Either an upper respiratory infection, such as a cold or sore throat, or a nasal allergic condition can produce enough congestion around the eustachian tube to make equalization difficult. Consequently, the difference in pressure between the middle ear and aircraft cabin can build up to a level that will hold the eustachian tube closed, making equalization difficult if not impossible. The problem is commonly referred to as an “ear block.”

3. An ear block produces severe ear pain and loss of hearing that can last from several hours to several days. Rupture of the ear drum can occur in flight or after landing. Fluid can accumulate in the middle ear and become infected.

4. An ear block is prevented by not flying with an upper respiratory infection or nasal allergic condition. Adequate protection is usually not provided by decongestant sprays or drops to reduce congestion around the eustachian tubes. Oral decongestants have side effects that can significantly impair pilot performance.

5. If an ear block does not clear shortly after landing, a physician should be consulted.

c. Sinus Block.

1. During ascent and descent, air pressure in the sinuses equalizes with the aircraft cabin pressure through small openings that connect the sinuses to the nasal passages. Either an upper respiratory infection, such as a cold or sinusitis, or a nasal allergic condition can produce enough congestion around an opening to slow equalization, and as the difference in pressure between the sinus and cabin mounts, eventually plug the opening. This “sinus block” occurs most frequently during descent.

2. A sinus block can occur in the frontal sinuses, located above each eyebrow, or in the maxillary sinuses, located in each upper cheek. It will usually produce excruciating pain over the sinus area. A maxillary sinus block can also make the upper teeth ache. Bloody mucus may discharge from the nasal passages.

3. A sinus block is prevented by not flying with an upper respiratory infection or nasal allergic condition. Adequate protection is usually not provided by decongestant sprays or drops to reduce congestion around the sinus openings. Oral decongestants have side effects that can impair pilot performance.

4. If a sinus block does not clear shortly after landing, a physician should be consulted.

d. Decompression Sickness After Scuba Diving.

1. A pilot or passenger who intends to fly after scuba diving should allow the body sufficient time to rid itself of excess nitrogen absorbed during diving. If not, decompression sickness due to evolved gas can occur during exposure to low altitude and create a serious inflight emergency.

2. The recommended waiting time before going to flight altitudes of up to 8,000 feet is at least 12 hours after diving which has not required controlled ascent (nondecompression stop diving), and at least 24 hours after diving which has required controlled ascent (decompression stop diving). The waiting time before going to flight altitudes above 8,000 feet should be at least 24 hours after any SCUBA dive. These recommended altitudes are actual flight altitudes above mean sea level (AMSL) and not pressurized cabin altitudes. This takes into consideration the risk of decompression of the aircraft during flight.

8-1-3. Hyperventilation in Flight

a. Hyperventilation, or an abnormal increase in the volume of air breathed in and out of the lungs, can occur subconsciously when a stressful situation is encountered in flight. As hyperventilation “blows off” excessive carbon dioxide from the body, a pilot can experience symptoms of lightheadedness, suffocation, drowsiness, tingling in the extremities, and coolness and react to them with even greater hyperventilation. Incapacitation can eventually result from incoordination, disorientation, and painful muscle spasms. Finally, unconsciousness can occur.

b. The symptoms of hyperventilation subside within a few minutes after the rate and depth of breathing are consciously brought back under control. The buildup of carbon dioxide in the body can be hastened by controlled breathing in and out of a paper bag held over the nose and mouth.

c. Early symptoms of hyperventilation and hypoxia are similar. Moreover, hyperventilation and hypoxia can occur at the same time. Therefore, if a pilot is using an oxygen system when symptoms are experienced, the oxygen regulator should immediately be set to deliver 100 percent oxygen, and then the system checked to assure that it has been functioning effectively before giving attention to rate and depth of breathing.

8-1-4. Carbon Monoxide Poisoning in Flight

a. Carbon monoxide is a colorless, odorless, and tasteless gas contained in exhaust fumes. When breathed even in minute quantities over a period of time, it can significantly reduce the ability of the blood to carry oxygen. Consequently, effects of hypoxia occur.

b. Most heaters in light aircraft work by air flowing over the manifold. Use of these heaters while exhaust fumes are escaping through manifold cracks and seals is responsible every year for several nonfatal and fatal aircraft accidents from carbon monoxide poisoning.

c. A pilot who detects the odor of exhaust or experiences symptoms of headache, drowsiness, or dizziness while using the heater should suspect carbon monoxide poisoning, and immediately shut off the heater and open air vents. If symptoms are

severe or continue after landing, medical treatment should be sought.

8-1-5. Illusions in Flight

a. **Introduction.** Many different illusions can be experienced in flight. Some can lead to spatial disorientation. Others can lead to landing errors. Illusions rank among the most common factors cited as contributing to fatal aircraft accidents.

b. Illusions Leading to Spatial Disorientation.

1. Various complex motions and forces and certain visual scenes encountered in flight can create illusions of motion and position. Spatial disorientation from these illusions can be prevented only by visual reference to reliable, fixed points on the ground or to flight instruments.

2. **The leans.** An abrupt correction of a banked attitude, which has been entered too slowly to stimulate the motion sensing system in the inner ear, can create the illusion of banking in the opposite direction. The disoriented pilot will roll the aircraft back into its original dangerous attitude, or if level flight is maintained, will feel compelled to lean in the perceived vertical plane until this illusion subsides.

(a) **Coriolis illusion.** An abrupt head movement in a prolonged constant-rate turn that has ceased stimulating the motion sensing system can create the illusion of rotation or movement in an entirely different axis. The disoriented pilot will maneuver the aircraft into a dangerous attitude in an attempt to stop rotation. This most overwhelming of all illusions in flight may be prevented by not making sudden, extreme head movements, particularly while making prolonged constant-rate turns under IFR conditions.

(b) **Graveyard spin.** A proper recovery from a spin that has ceased stimulating the motion sensing system can create the illusion of spinning in the opposite direction. The disoriented pilot will return the aircraft to its original spin.

(c) **Graveyard spiral.** An observed loss of altitude during a coordinated constant-rate turn that has ceased stimulating the motion sensing system can create the illusion of being in a descent with the wings level. The disoriented pilot will pull back on the controls, tightening the spiral and increasing the loss of altitude.

(d) **Somatogravic illusion.** A rapid acceleration during takeoff can create the illusion of being

in a nose up attitude. The disoriented pilot will push the aircraft into a nose low, or dive attitude. A rapid deceleration by a quick reduction of the throttles can have the opposite effect, with the disoriented pilot pulling the aircraft into a nose up, or stall attitude.

(e) Inversion illusion. An abrupt change from climb to straight and level flight can create the illusion of tumbling backwards. The disoriented pilot will push the aircraft abruptly into a nose low attitude, possibly intensifying this illusion.

(f) Elevator illusion. An abrupt upward vertical acceleration, usually by an updraft, can create the illusion of being in a climb. The disoriented pilot will push the aircraft into a nose low attitude. An abrupt downward vertical acceleration, usually by a downdraft, has the opposite effect, with the disoriented pilot pulling the aircraft into a nose up attitude.

(g) False horizon. Sloping cloud formations, an obscured horizon, a dark scene spread with ground lights and stars, and certain geometric patterns of ground light can create illusions of not being aligned correctly with the actual horizon. The disoriented pilot will place the aircraft in a dangerous attitude.

(h) Autokinesis. In the dark, a static light will appear to move about when stared at for many seconds. The disoriented pilot will lose control of the aircraft in attempting to align it with the light.

3. Illusions Leading to Landing Errors.

(a) Various surface features and atmospheric conditions encountered in landing can create illusions of incorrect height above and distance from the runway threshold. Landing errors from these illusions can be prevented by anticipating them during approaches, aerial visual inspection of unfamiliar airports before landing, using electronic glide slope or VASI systems when available, and maintaining optimum proficiency in landing procedures.

(b) Runway width illusion. A narrower-than-usual runway can create the illusion that the aircraft is at a higher altitude than it actually is. The pilot who does not recognize this illusion will fly a lower approach, with the risk of striking objects along the approach path or landing short. A wider-than-usual runway can have the opposite effect, with the

risk of leveling out high and landing hard or overshooting the runway.

(c) Runway and terrain slopes illusion. An upsloping runway, upsloping terrain, or both, can create the illusion that the aircraft is at a higher altitude than it actually is. The pilot who does not recognize this illusion will fly a lower approach. A downsloping runway, downsloping approach terrain, or both, can have the opposite effect.

(d) Featureless terrain illusion. An absence of ground features, as when landing over water, darkened areas, and terrain made featureless by snow, can create the illusion that the aircraft is at a higher altitude than it actually is. The pilot who does not recognize this illusion will fly a lower approach.

(e) Atmospheric illusions. Rain on the windscreen can create the illusion of greater height, and atmospheric haze the illusion of being at a greater distance from the runway. The pilot who does not recognize these illusions will fly a lower approach. Penetration of fog can create the illusion of pitching up. The pilot who does not recognize this illusion will steepen the approach, often quite abruptly.

(f) Ground lighting illusions. Lights along a straight path, such as a road, and even lights on moving trains can be mistaken for runway and approach lights. Bright runway and approach lighting systems, especially where few lights illuminate the surrounding terrain, may create the illusion of less distance to the runway. The pilot who does not recognize this illusion will fly a higher approach. Conversely, the pilot overflying terrain which has few lights to provide height cues may make a lower than normal approach.

8-1-6. Vision in Flight

a. Introduction. Of the body senses, vision is the most important for safe flight. Major factors that determine how effectively vision can be used are the level of illumination and the technique of scanning the sky for other aircraft.

b. Vision Under Dim and Bright Illumination.

1. Under conditions of dim illumination, small print and colors on aeronautical charts and aircraft instruments become unreadable unless adequate cockpit lighting is available. Moreover, another aircraft must be much closer to be seen unless its navigation lights are on.

2. In darkness, vision becomes more sensitive to light, a process called dark adaptation. Although exposure to total darkness for at least 30 minutes is required for complete dark adaptation, a pilot can achieve a moderate degree of dark adaptation within 20 minutes under dim red cockpit lighting. Since red light severely distorts colors, especially on aeronautical charts, and can cause serious difficulty in focusing the eyes on objects inside the aircraft, its use is advisable only where optimum outside night vision capability is necessary. Even so, white cockpit lighting must be available when needed for map and instrument reading, especially under IFR conditions. Dark adaptation is impaired by exposure to cabin pressure altitudes above 5,000 feet, carbon monoxide inhaled in smoking and from exhaust fumes, deficiency of Vitamin A in the diet, and by prolonged exposure to bright sunlight. Since any degree of dark adaptation is lost within a few seconds of viewing a bright light, a pilot should close one eye when using a light to preserve some degree of night vision.

3. Excessive illumination, especially from light reflected off the canopy, surfaces inside the aircraft, clouds, water, snow, and desert terrain, can produce glare, with uncomfortable squinting, watering of the eyes, and even temporary blindness. Sunglasses for protection from glare should absorb at least 85 percent of visible light (15 percent transmittance) and all colors equally (neutral transmittance), with negligible image distortion from refractive and prismatic errors.

c. Scanning for Other Aircraft.

1. Scanning the sky for other aircraft is a key factor in collision avoidance. It should be used continuously by the pilot and copilot (or right seat passenger) to cover all areas of the sky visible from the cockpit. Although pilots must meet specific visual acuity requirements, the ability to read an eye chart does not ensure that one will be able to efficiently spot other aircraft. Pilots must develop an effective scanning technique which maximizes one's visual capabilities. The probability of spotting a potential collision threat obviously increases with the time spent looking outside the cockpit. Thus, one must use timesharing techniques to efficiently scan the surrounding airspace while monitoring instruments as well.

2. While the eyes can observe an approximate 200 degree arc of the horizon at one glance, only a very small center area called the fovea, in the rear of the eye, has the ability to send clear, sharply focused messages to the brain. All other visual information that is not processed directly through the fovea will be of less detail. An aircraft at a distance of 7 miles which appears in sharp focus within the foveal center of vision would have to be as close as $\frac{7}{10}$ of a mile in order to be recognized if it were outside of foveal vision. Because the eyes can focus only on this narrow viewing area, effective scanning is accomplished with a series of short, regularly spaced eye movements that bring successive areas of the sky into the central visual field. Each movement should not exceed 10 degrees, and each area should be observed for at least 1 second to enable detection. Although horizontal back-and-forth eye movements seem preferred by most pilots, each pilot should develop a scanning pattern that is most comfortable and then adhere to it to assure optimum scanning.

3. Studies show that the time a pilot spends on visual tasks inside the cabin should represent no more than $\frac{1}{4}$ to $\frac{1}{3}$ of the scan time outside, or no more than 4 to 5 seconds on the instrument panel for every 16 seconds outside. Since the brain is already trained to process sight information that is presented from left to right, one may find it easier to start scanning over the left shoulder and proceed across the windshield to the right.

4. Pilots should realize that their eyes may require several seconds to refocus when switching views between items in the cockpit and distant objects. The eyes will also tire more quickly when forced to adjust to distances immediately after close-up focus, as required for scanning the instrument panel. Eye fatigue can be reduced by looking from the instrument panel to the left wing past the wing tip to the center of the first scan quadrant when beginning the exterior scan. After having scanned from left to right, allow the eyes to return to the cabin along the right wing from its tip inward. Once back inside, one should automatically commence the panel scan.

5. Effective scanning also helps avoid "empty-field myopia." This condition usually occurs when flying above the clouds or in a haze layer that provides nothing specific to focus on outside the aircraft. This causes the eyes to relax and seek a

comfortable focal distance which may range from 10 to 30 feet. For the pilot, this means looking without seeing, which is dangerous.

8-1-7. Aerobic Flight

a. Pilots planning to engage in aerobatics should be aware of the physiological stresses associated with accelerative forces during aerobatic maneuvers. Many prospective aerobatic trainees enthusiastically enter aerobatic instruction but find their first experiences with G forces to be unanticipated and very uncomfortable. To minimize or avoid potential adverse effects, the aerobatic instructor and trainee must have a basic understanding of the physiology of G force adaptation.

b. Forces experienced with a rapid push-over maneuver result in the blood and body organs being displaced toward the head. Depending on forces involved and individual tolerance, a pilot may experience discomfort, headache, “red-out,” and even unconsciousness.

c. Forces experienced with a rapid pull-up maneuver result in the blood and body organ displacement toward the lower part of the body away from the head. Since the brain requires continuous blood circulation for an adequate oxygen supply, there is a physiologic limit to the time the pilot can tolerate higher forces before losing consciousness. As the blood circulation to the brain decreases as a result of forces involved, a pilot will experience “narrowing” of visual fields, “gray-out,” “black-out,” and unconsciousness. Even a brief loss of consciousness in a maneuver can lead to improper control movement causing structural failure of the aircraft or collision with another object or terrain.

d. In steep turns, the centrifugal forces tend to push the pilot into the seat, thereby resulting in blood and body organ displacement toward the lower part of the body as in the case of rapid pull-up maneuvers and with the same physiologic effects and symptoms.

e. Physiologically, humans progressively adapt to imposed strains and stress, and with practice, any maneuver will have decreasing effect. Tolerance to G forces is dependent on human physiology and the individual pilot. These factors include the skeletal anatomy, the cardiovascular architecture, the nervous system, the quality of the blood, the general physical state, and experience and recency of exposure. The

pilot should consult an Aviation Medical Examiner prior to aerobatic training and be aware that poor physical condition can reduce tolerance to accelerative forces.

f. The above information provides pilots with a brief summary of the physiologic effects of G forces. It does not address methods of “counteracting” these effects. There are numerous references on the subject of G forces during aerobatics available to pilots. Among these are “G Effects on the Pilot During Aerobatics,” FAA-AM-72-28, and “G Incapacitation in Aerobatic Pilots: A Flight Hazard” FAA-AM-82-13. These are available from the National Technical Information Service, Springfield, Virginia 22161.

REFERENCE-

FAA AC 91-61, *A Hazard in Aerobatics: Effects of G-forces on Pilots.*

8-1-8. Judgment Aspects of Collision Avoidance

a. Introduction. The most important aspects of vision and the techniques to scan for other aircraft are described in paragraph 8-1-6, Vision in Flight. Pilots should also be familiar with the following information to reduce the possibility of mid-air collisions.

b. Determining Relative Altitude. Use the horizon as a reference point. If the other aircraft is above the horizon, it is probably on a higher flight path. If the aircraft appears to be below the horizon, it is probably flying at a lower altitude.

c. Taking Appropriate Action. Pilots should be familiar with rules on right-of-way, so if an aircraft is on an obvious collision course, one can take immediate evasive action, preferably in compliance with applicable Federal Aviation Regulations.

d. Consider Multiple Threats. The decision to climb, descend, or turn is a matter of personal judgment, but one should anticipate that the other pilot may also be making a quick maneuver. Watch the other aircraft during the maneuver and begin your scanning again immediately since there may be other aircraft in the area.

e. Collision Course Targets. Any aircraft that appears to have no relative motion and stays in one scan quadrant is likely to be on a collision course. Also, if a target shows no lateral or vertical motion, but increases in size, *take evasive action.*

f. Recognize High Hazard Areas.

1. Airways, especially near VORs, and Class B, Class C, Class D, and Class E surface areas are places where aircraft tend to cluster.

2. Remember, most collisions occur during days when the weather is good. Being in a “radar environment” still requires vigilance to avoid collisions.

g. Cockpit Management. Studying maps, checklists, and manuals before flight, with other proper preflight planning; e.g., noting necessary radio frequencies and organizing cockpit materials, can reduce the amount of time required to look at these items during flight, permitting more scan time.

h. Windshield Conditions. Dirty or bug-smearred windshields can greatly reduce the ability of pilots to see other aircraft. Keep a clean windshield.

i. Visibility Conditions. Smoke, haze, dust, rain, and flying towards the sun can also greatly reduce the ability to detect targets.

j. Visual Obstructions in the Cockpit.

1. Pilots need to move their heads to see around blind spots caused by fixed aircraft structures, such as door posts, wings, etc. It will be necessary at times to maneuver the aircraft; e.g., lift a wing, to facilitate seeing.

2. Pilots must ensure curtains and other cockpit objects; e.g., maps on glare shield, are removed and stowed during flight.

k. Lights On.

1. Day or night, use of exterior lights can greatly increase the conspicuity of any aircraft.

2. Keep interior lights low at night.

l. ATC Support. ATC facilities often provide radar traffic advisories on a workload-permitting basis. Flight through Class C and Class D airspace requires communication with ATC. Use this support whenever possible or when required.

Chapter 9. Aeronautical Charts and Related Publications

Section 1. Types of Charts Available

9-1-1. General

Civil aeronautical charts for the U.S. and its territories, and possessions are produced by Aeronautical Information Services (AIS), http://www.faa.gov/air_traffic/flight_info/aeronav which is part of FAA's Air Traffic Organization, Mission Support Services.

9-1-2. Obtaining Aeronautical Charts

Public sales of charts and publications are available through a network of FAA approved print providers. A listing of products, dates of latest editions and agents is available on the AIS website at: http://www.faa.gov/air_traffic/flight_info/aeronav.

9-1-3. Selected Charts and Products Available

VFR Navigation Charts
IFR Navigation Charts
Planning Charts
Supplementary Charts and Publications
Digital Products

9-1-4. General Description of Each Chart Series

a. VFR Navigation Charts.

1. Sectional Aeronautical Charts. Sectional Charts are designed for visual navigation of slow to medium speed aircraft. The topographic information consists of contour lines, shaded relief, drainage patterns, and an extensive selection of visual checkpoints and landmarks used for flight under VFR. Cultural features include cities and towns,

roads, railroads, and other distinct landmarks. The aeronautical information includes visual and radio aids to navigation, airports, controlled airspace, special-use airspace, obstructions, and related data. Scale 1 inch = 6.86 nm/1:500,000. 60 x 20 inches folded to 5 x 10 inches. Revised biannually, except most Alaskan charts are revised annually. (See FIG 9-1-1 and FIG 9-1-2.)

2. VFR Terminal Area Charts (TAC). TACs depict the airspace designated as Class B airspace. While similar to sectional charts, TACs have more detail because the scale is larger. The TAC should be used by pilots intending to operate to or from airfields within or near Class B or Class C airspace. Areas with TAC coverage are indicated by a • on the Sectional Chart indexes. Scale 1 inch = 3.43 nm/1:250,000. Charts are revised biannually, except Puerto Rico-Virgin Islands which is revised annually. (See FIG 9-1-1 and FIG 9-1-2.)

3. U.S. Gulf Coast VFR Aeronautical Chart. The Gulf Coast Chart is designed primarily for helicopter operation in the Gulf of Mexico area. Information depicted includes offshore mineral leasing areas and blocks, oil drilling platforms, and high density helicopter activity areas. Scale 1 inch = 13.7 nm/1:1,000,000. 55 x 27 inches folded to 5 x 10 inches. Revised annually.

4. Grand Canyon VFR Aeronautical Chart. Covers the Grand Canyon National Park area and is designed to promote aviation safety, flight free zones, and facilitate VFR navigation in this popular area. The chart contains aeronautical information for general aviation VFR pilots on one side and commercial VFR air tour operators on the other side.

FIG 9-1-1
**Sectional and VFR Terminal Area Charts for the Conterminous U.S.,
Hawaii, Puerto Rico, and Virgin Islands**

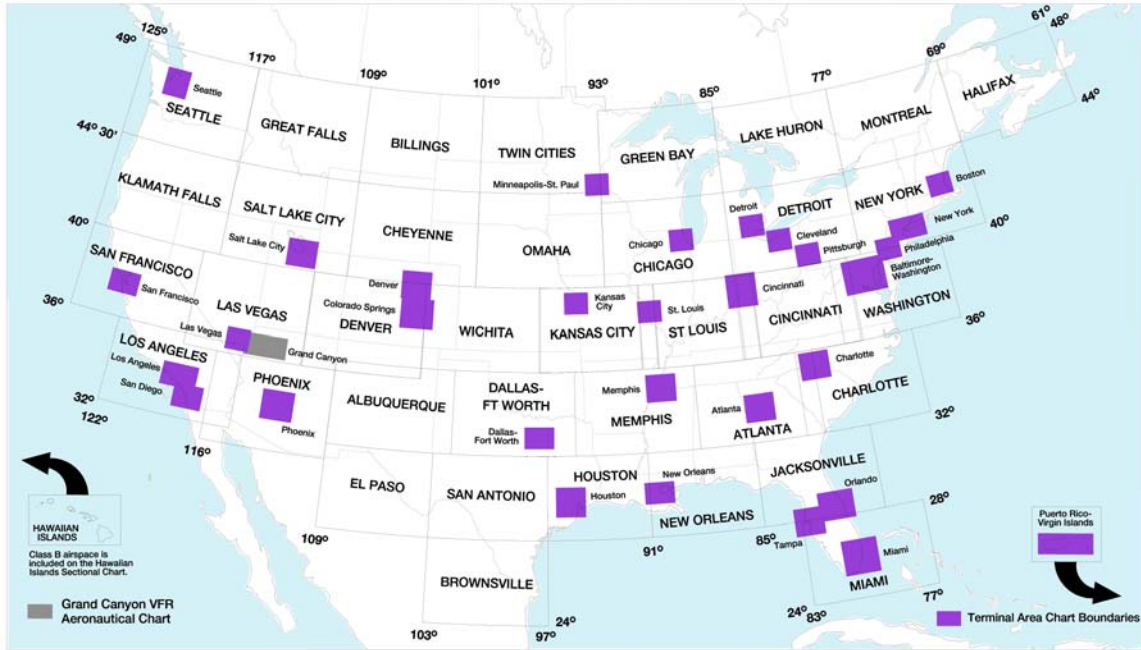
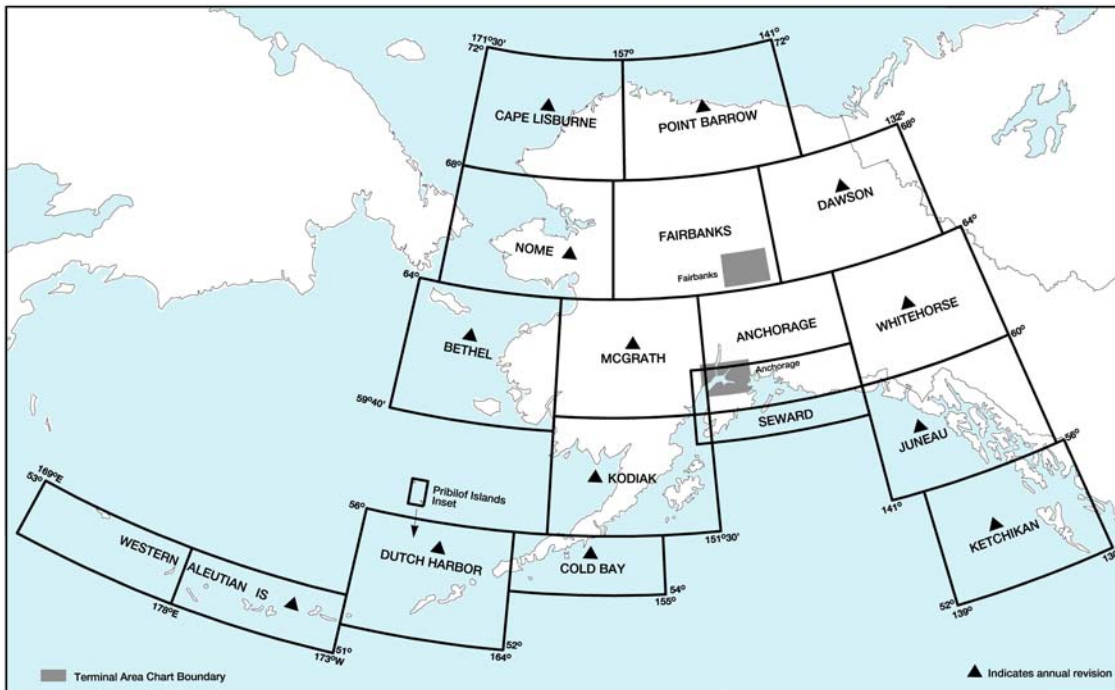

FIG 9-1-2
Sectional and VFR Terminal Area Charts for Alaska



5. Caribbean VFR Aeronautical Charts.

Caribbean 1 and 2 (CAC-1 and CAC-2) are designed for visual navigation to assist familiarization of foreign aeronautical and topographic information. The aeronautical information includes visual and radio aids to navigation, airports, controlled airspace, special-use airspace, obstructions, and related data. The topographic information consists of contour

lines, shaded relief, drainage patterns, and a selection of landmarks used for flight under VFR. Cultural features include cities and towns, roads, railroads, and other distinct landmarks. Scale 1 inch = 13.7 nm/1:1,000,000. CAC-1, revised annually, consists of two sides measuring 30" x 60" each. CAC-2, revised biennially, consists of two sides measuring 20" x 60" each. (See FIG 9-1-3.)

FIG 9-1-3
Caribbean VFR Aeronautical Charts

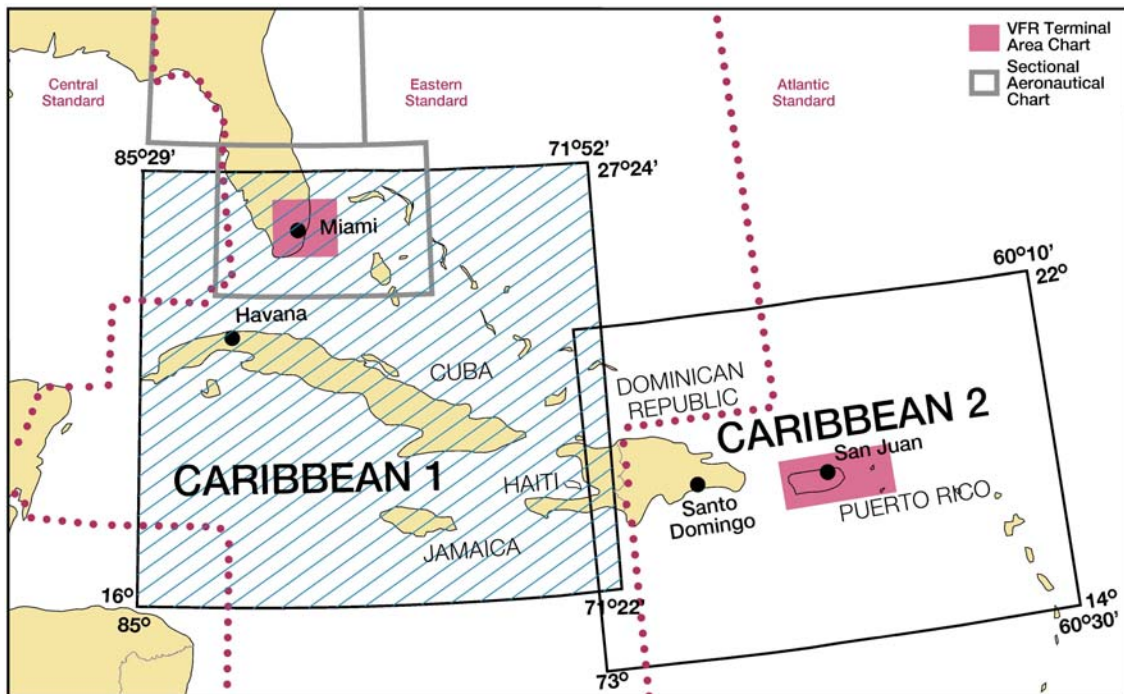

6. Helicopter Route Charts. A three-color chart series which shows current aeronautical information useful to helicopter pilots navigating in areas with high concentrations of helicopter activity. Information depicted includes helicopter routes, four classes of heliports with associated frequency and lighting capabilities, NAVAIDs, and obstructions. In

addition, pictorial symbols, roads, and easily identified geographical features are portrayed. Helicopter charts have a longer life span than other chart products and may be current for several years. Helicopter Route Charts are updated as requested by the FAA. Scale 1 inch = 1.71 nm/1:125,000. 34 x 30 inches folded to 5 x 10 inches. (See FIG 9-1-4.)

FIG 9-1-4
Helicopter Route Charts

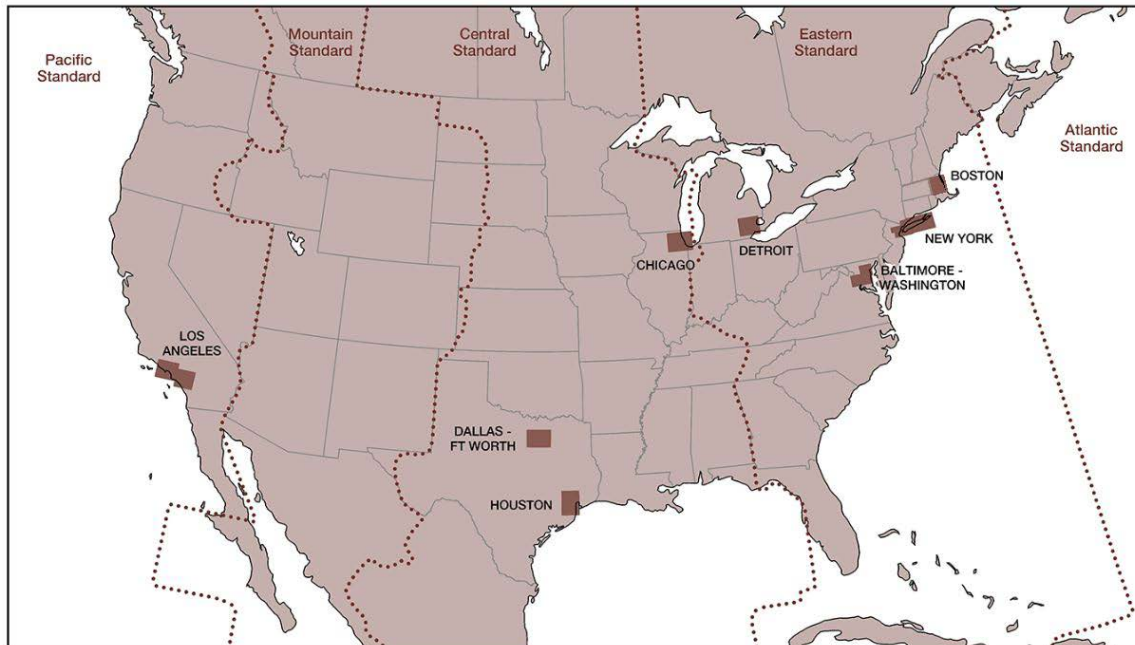

b. IFR Navigation Charts.

1. IFR En Route Low Altitude Charts (Conterminous U.S. and Alaska). En route low altitude charts provide aeronautical information for navigation under IFR conditions below 18,000 feet MSL. This four-color chart series includes airways; limits of controlled airspace; VHF NAVAIDs with frequency, identification, channel, geographic coordinates; airports with terminal air/ground

communications; minimum en route and obstruction clearance altitudes; airway distances; reporting points; special use airspace; and military training routes. Scales vary from 1 inch = 5nm to 1 inch = 20 nm. 50 x 20 inches folded to 5 x 10 inches. Charts revised every 56 days. *Area charts* show congested terminal areas at a large scale. They are included with subscriptions to any conterminous U.S. Set Low (Full set, East or West sets). (See FIG 9-1-5 and FIG 9-1-6.)

FIG 9-1-5
En Route Low Altitude Instrument Charts for the Conterminous U.S. (Includes Area Charts)

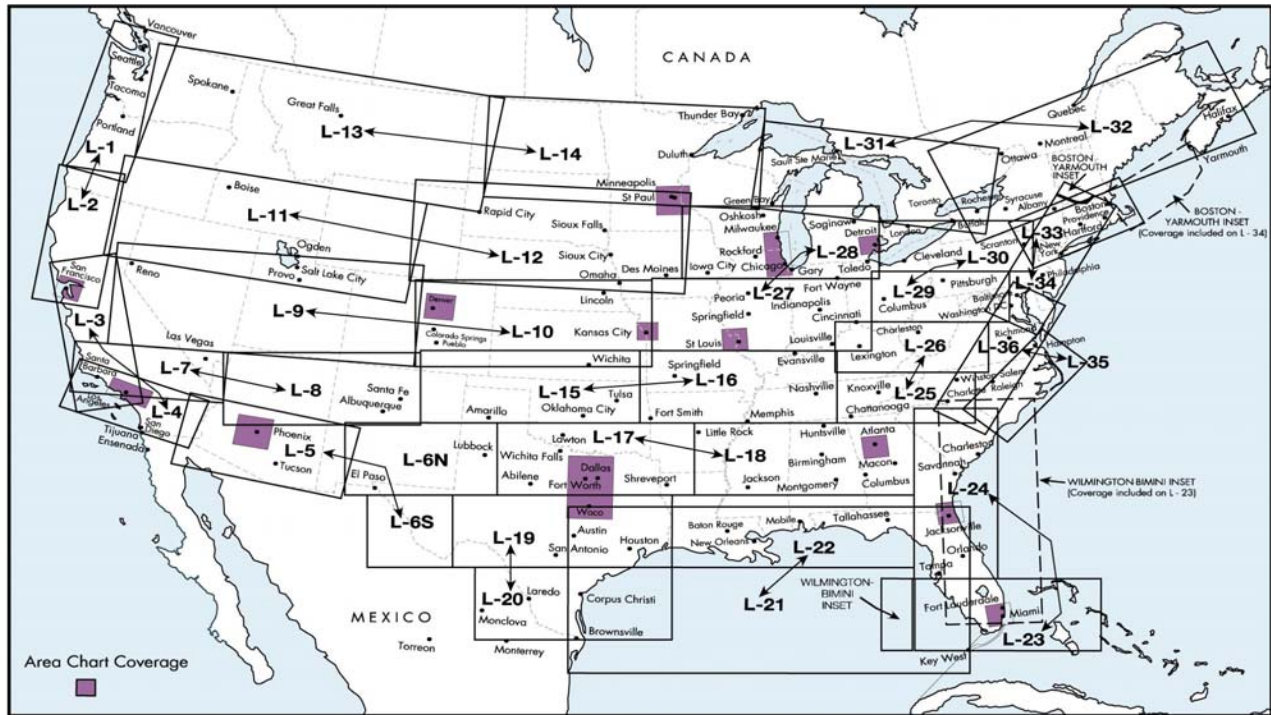
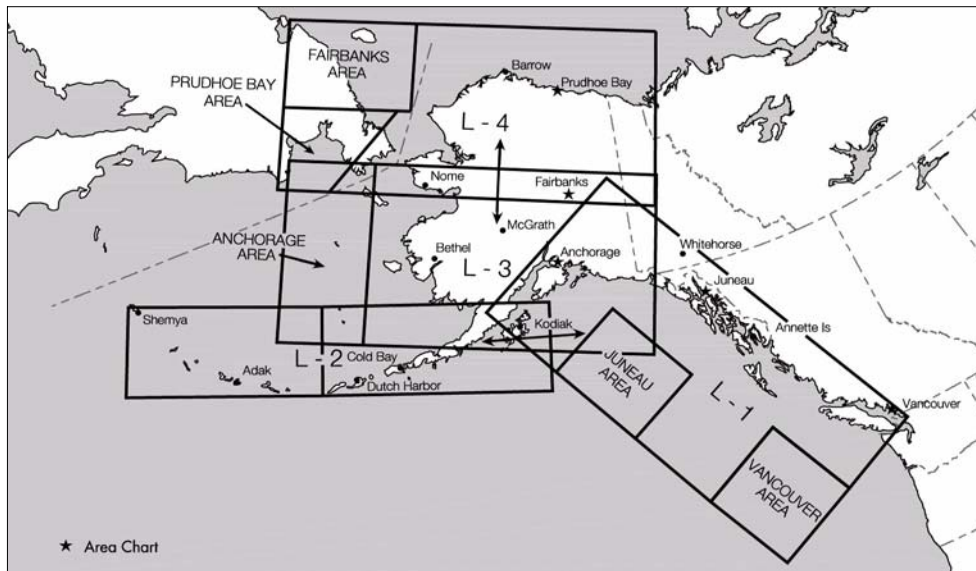

FIG 9-1-6
Alaska En Route Low Altitude Chart



2. IFR En Route High Altitude Charts (Conterminous U.S. and Alaska). En route high altitude charts are designed for navigation at or above 18,000 feet MSL. This four-color chart series includes the jet route structure; VHF NAVAIDs with

frequency, identification, channel, geographic coordinates; selected airports; reporting points. Scales vary from 1 inch = 45 nm to 1 inch = 18 nm. 55 x 20 inches folded to 5 x 10 inches. Revised every 56 days. (See FIG 9-1-7 and FIG 9-1-8.)

**FIG 9-1-7
En Route High Altitude Charts for the Conterminous U.S.**

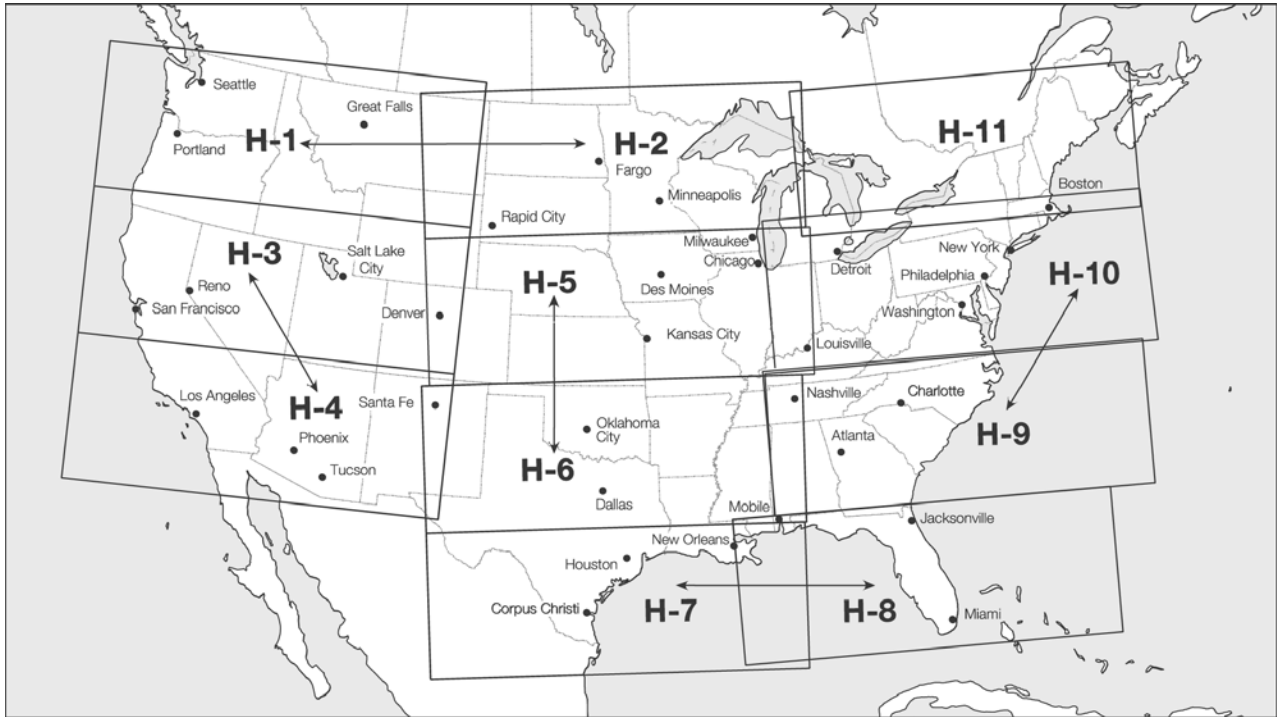

**FIG 9-1-8
Alaskan En Route High Altitude Chart**

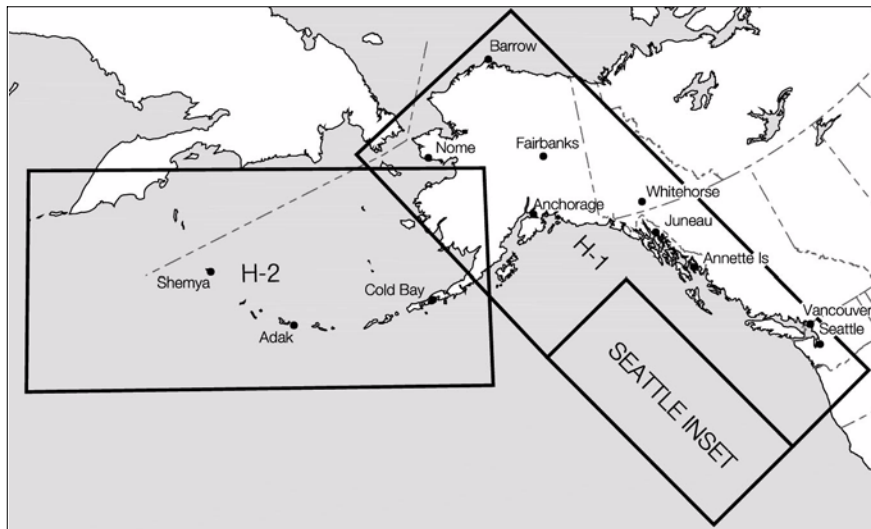

3. U.S. Terminal Procedures Publication (TPP). TPPs are published in 24 loose-leaf or perfect bound volumes covering the conterminous U.S., Puerto Rico and the Virgin Islands. A Change Notice is published at the midpoint between revisions in bound volume format and is available on the internet for free download at the AIS website. (See FIG 9-1-15.) The TPPs include:

(a) Instrument Approach Procedure (IAP)

Charts. IAP charts portray the aeronautical data that is required to execute instrument approaches to airports. Each chart depicts the IAP, all related navigation data, communications information, and an airport sketch. Each procedure is designated for use with a specific electronic navigational aid, such as ILS, VOR, NDB, RNAV, etc.

(b) Instrument Departure Procedure (DP)

Charts. DP charts are designed to expedite clearance delivery and to facilitate transition between takeoff and en route operations. They furnish pilots' departure routing clearance information in graphic and textual form.

(c) Standard Terminal Arrival (STAR)

Charts. STAR charts are designed to expedite ATC arrival procedures and to facilitate transition between en route and instrument approach operations. They depict preplanned IFR ATC arrival procedures in graphic and textual form. Each STAR procedure is presented as a separate chart and may serve either a single airport or more than one airport in a given geographic area.

(d) Airport Diagrams. Full page airport diagrams are designed to assist in the movement of ground traffic at locations with complex runway/taxiway configurations and provide information for updating geodetic position navigational systems aboard aircraft. Airport diagrams are available for free download at the AIS website.

4. Alaska Terminal Procedures Publication.

This publication contains all terminal flight procedures for civil and military aviation in Alaska.

Included are IAP charts, DP charts, STAR charts, airport diagrams, radar minimums, and supplementary support data such as IFR alternate minimums, take-off minimums, rate of descent tables, rate of climb tables and inoperative components tables. Volume is 5-3/8 x 8-1/4 inch top bound. Publication revised every 56 days with provisions for a Terminal Change Notice, as required.

c. Planning Charts.

1. U.S. IFR/VFR Low Altitude Planning Chart. This chart is designed for preflight and en route flight planning for IFR/VFR flights. Depiction includes low altitude airways and mileage, NAVAIDs, airports, special use airspace, cities, times zones, major drainage, a directory of airports with their airspace classification, and a mileage table showing great circle distances between major airports. Scale 1 inch = 47nm/1:3,400,000. Chart revised annually, and is available either folded or unfolded for wall mounting. (See FIG 9-1-10.)

2. Gulf of Mexico and Caribbean Planning Chart. This is a VFR planning chart on the reverse side of the *Puerto Rico - Virgin Islands VFR Terminal Area Chart*. Information shown includes mileage between airports of entry, a selection of special use airspace and a directory of airports with their available services. Scale 1 inch = 85nm/1:6,192,178. 60 x 20 inches folded to 5 x 10 inches. Chart revised annually. (See FIG 9-1-10.)

3. Alaska VFR Wall Planning Chart. This chart is designed for VFR preflight planning and chart selection. It includes aeronautical and topographic information of the state of Alaska. The aeronautical information includes public and military airports; radio aids to navigation; and Class B, Class C, TRSA and special-use airspace. The topographic information includes city tint, populated places, principal roads, and shaded relief. Scale 1 inch = 27.4 nm/1:2,000,000. The one sided chart is 58.5 x 40.75 inches and is designed for wall mounting. Chart is revised biennially. (See FIG 9-1-9.)

FIG 9-1-9
Alaska VFR Wall Planning Chart

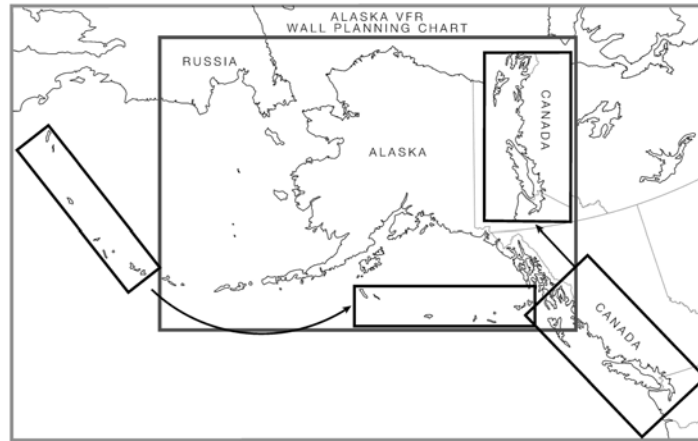
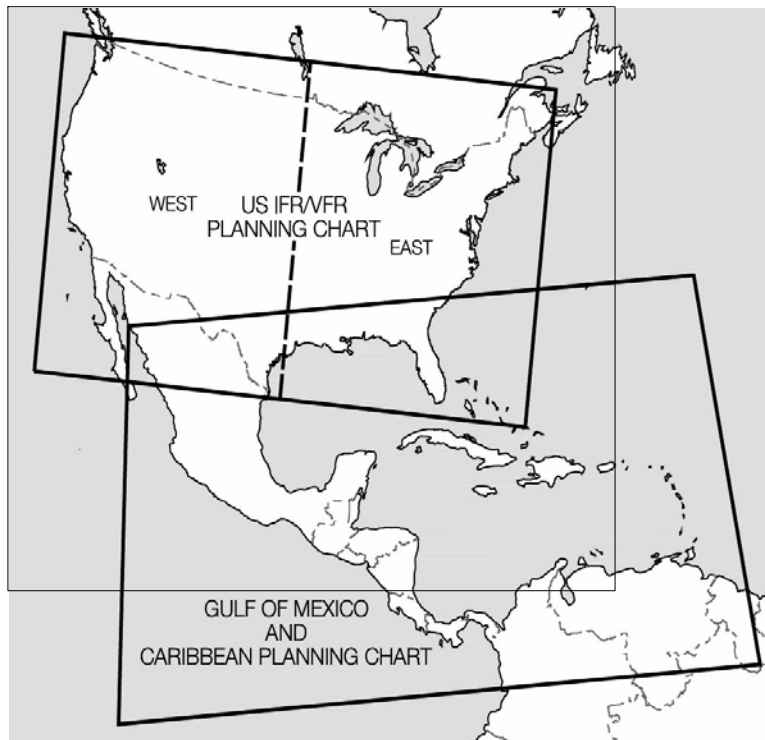

FIG 9-1-10
Planning Charts



4. U.S. VFR Wall Planning Chart. This chart is designed for VFR preflight planning and chart selection. It includes aeronautical and topographic information of the conterminous U.S. The aeronautical information includes airports, radio aids to navigation, Class B airspace and special use airspace. The topographic information includes city tint, populated places, principal roads, drainage patterns, and shaded relief. Scale 1 inch = 43 nm/ 1:3,100,000. The one-sided chart is 59 x 36 inches and ships unfolded for wall mounting. Chart is revised biennially. (See FIG 9-1-11.)

FIG 9-1-11
U.S. VFR Wall Planning Chart



5. Charted VFR Flyway Planning Charts. This chart is printed on the reverse side of selected TAC charts. The coverage is the same as the associated TAC. Flyway planning charts depict flight paths and altitudes recommended for use to bypass high traffic areas. Ground references are provided as a guide for visual orientation. Flyway planning charts are designed for use in conjunction with TACs and sectional charts and are not to be used for navigation. Chart scale 1 inch = 3.43 nm/1:250,000.

d. Supplementary Charts and Publications.

1. Chart Supplement U.S. This 7-volume booklet series contains data on airports, seaplane bases, heliports, NAVAIDs, communications data, weather data sources, airspace, special notices, and operational procedures. Coverage includes the conterminous U.S., Puerto Rico, and the Virgin

Islands. The Chart Supplement U.S. shows data that cannot be readily depicted in graphic form; for example, airport hours of operations, types of fuel available, runway widths, lighting codes, etc. The Chart Supplement U.S. also provides a means for pilots to update visual charts between edition dates (The Chart Supplement U.S. is published every 56 days while Sectional Aeronautical and VFR Terminal Area Charts are generally revised every six months). The Aeronautical Chart Bulletins (VFR Chart Update Bulletins) are available for free download at the AIS website. Volumes are side-bound 5-3/8 x 8-1/4 inches. (See FIG 9-1-14.)

2. Chart Supplement Alaska. This is a civil/military flight information publication issued by FAA every 56 days. It is a single volume booklet designed for use with appropriate IFR or VFR charts. The Chart Supplement Alaska contains airport sketches, communications data, weather data sources, airspace, listing of navigational facilities, and special notices and procedures. Volume is side-bound 5-3/8 x 8-1/4 inches.

3. Chart Supplement Pacific. This supplement is designed for use with appropriate VFR or IFR en route charts. Included in this one-volume booklet are the chart supplement, communications data, weather data sources, airspace, navigational facilities, special notices, and Pacific area procedures. IAP charts, DP charts, STAR charts, airport diagrams, radar minimums, and supporting data for the Hawaiian and Pacific Islands are included. The manual is published every 56 days. Volume is side-bound 5-3/8 x 8-1/4 inches.

4. North Atlantic Route Chart. Designed for FAA controllers to monitor transatlantic flights, this 5-color chart shows oceanic control areas, coastal navigation aids, oceanic reporting points, and NAVAID geographic coordinates. Full Size Chart: Scale 1 inch = 113.1 nm/1:8,250,000. Chart is shipped flat only. Half Size Chart: Scale 1 inch = 150.8 nm/1:11,000,000. Chart is 29-3/4 x 20-1/2 inches, shipped folded to 5 x 10 inches only. Chart revised every 56 weeks. (See FIG 9-1-12.)

FIG 9-1-12
North Atlantic Route Charts

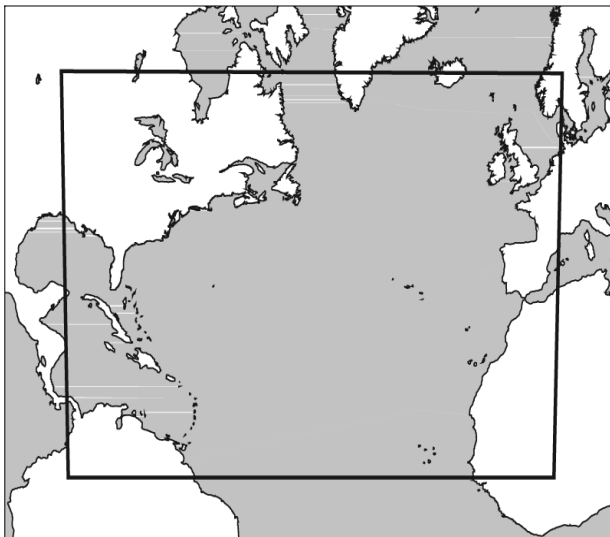

5. North Pacific Route Charts. These charts are designed for FAA controllers to monitor transoceanic flights. They show established intercontinental air routes, including reporting points with geographic positions. Composite Chart: Scale 1 inch = 164 nm/1:12,000,000. 48 x 41-1/2 inches. Area Charts: Scale 1 inch = 95.9 nm/1:7,000,000. 52 x 40-1/2 inches. All charts shipped unfolded. Charts revised every 56 days. (See FIG 9-1-13.)

FIG 9-1-13
North Pacific Oceanic Route Charts

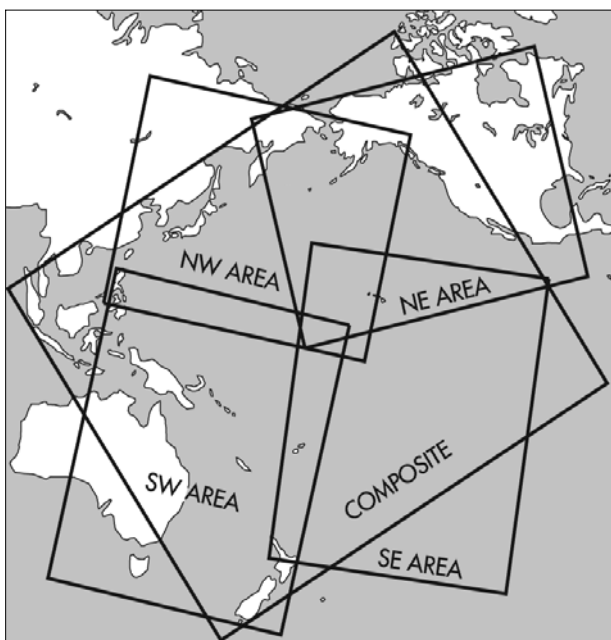

6. Airport Obstruction Charts (OC). The OC is a 1:12,000 scale graphic depicting 14 CFR Part 77, Objects Affecting Navigable Airspace, surfaces, a representation of objects that penetrate these surfaces, aircraft movement and apron areas, navigational aids, prominent airport buildings, and a selection of roads and other planimetric detail in the airport vicinity. Also included are tabulations of runway and other operational data.

7. FAA Aeronautical Chart User's Guide. A booklet designed to be used as a teaching aid and reference document. It describes the substantial amount of information provided on FAA's aeronautical charts and publications. It includes explanations and illustrations of chart terms and symbols organized by chart type. The users guide is available for free download at the AIS website.

e. Digital Products.

1. The Digital Aeronautical Information CD (DAICD). The DAICD is a combination of the NAVAID Digital Data File, the Digital Chart Supplement, and the Digital Obstacle File on one Compact Disk. These three digital products are no longer sold separately. The files are updated every 56 days and are available by subscription only.

(a) The NAVAID Digital Data File. This file contains a current listing of NAVAIDs that are compatible with the National Airspace System. This file contains all NAVAIDs including ILS and its components, in the U.S., Puerto Rico, and the Virgin Islands plus bordering facilities in Canada, Mexico, and the Atlantic and Pacific areas.

(b) The Digital Obstacle File. This file describes all obstacles of interest to aviation users in the U.S., with limited coverage of the Pacific, Caribbean, Canada, and Mexico. The obstacles are assigned unique numerical identifiers, accuracy codes, and listed in order of ascending latitude within each state or area.

(c) The Digital Aeronautical Chart Supplement (DACS). The DACS is specifically designed to provide digital airspace data not otherwise readily available. The supplement includes a *Change Notice* for IAPFIX.dat at the mid-point between revisions. The *Change Notice* is available only by free download at the AIS website.

The DACS individual data files are:

ENHIGH.DAT: High altitude airways (conterminous U.S.)

ENLOW.DAT: Low altitude airways (conterminous U.S.)

IAPFIX.DAT: Selected instrument approach procedure NAVAID and fix data.

MTRFIX.DAT: Military training routes data.

ALHIGH.DAT: Alaska high altitude airways data.

ALLOW.DAT: Alaska low altitude airways data.

PR.DAT: Puerto Rico airways data.

HAWAII.DAT: Hawaii airways data.

BAHAMA.DAT: Bahamas routes data.

OCEANIC.DAT: Oceanic routes data.

STARS.DAT: Standard terminal arrivals data.

DP.DAT: Instrument departure procedures data.

LOPREF.DAT: Preferred low altitude IFR routes data.

HIPREF.DAT: Preferred high altitude IFR routes data.

ARF.DAT: Air route radar facilities data.

ASR.DAT: Airport surveillance radar facilities data.

2. The Coded Instrument Flight Procedures (CIFP) (ARINC 424 [Ver 13 & 15]). The CIFP is a basic digital dataset, modeled to an international

standard, which can be used as a basis to support GPS navigation. Initial data elements included are: Airport and Helicopter Records, VHF and NDB Navigation aids, en route waypoints and airways. Additional data elements will be added in subsequent releases to include: departure procedures, standard terminal arrivals, and GPS/RNAV instrument approach procedures. The database is updated every 28 days. The data is available by subscription only and is distributed on CD-ROM or by ftp download.

3. digital-Visual Charts (d-VC). These digital VFR charts are geo-referenced images of FAA Sectional Aeronautical, TAC, and Helicopter Route charts. Additional digital data may easily be overlaid on the raster image using commonly available Geographic Information System software. Data such as weather, temporary flight restrictions, obstacles, or other geospatial data can be combined with d-VC data to support a variety of needs. The file resolution is 300 dots per inch and the data is 8-bit color. The data is provided as a GeoTIFF and distributed on DVD-R media and on the AIS website. The root mean square error of the transformation will not exceed two pixels. Digital-VC DVDs are updated every 28 days and are available by subscription only.

FIG 9-1-14

Chart Supplement U.S. Geographic Areas

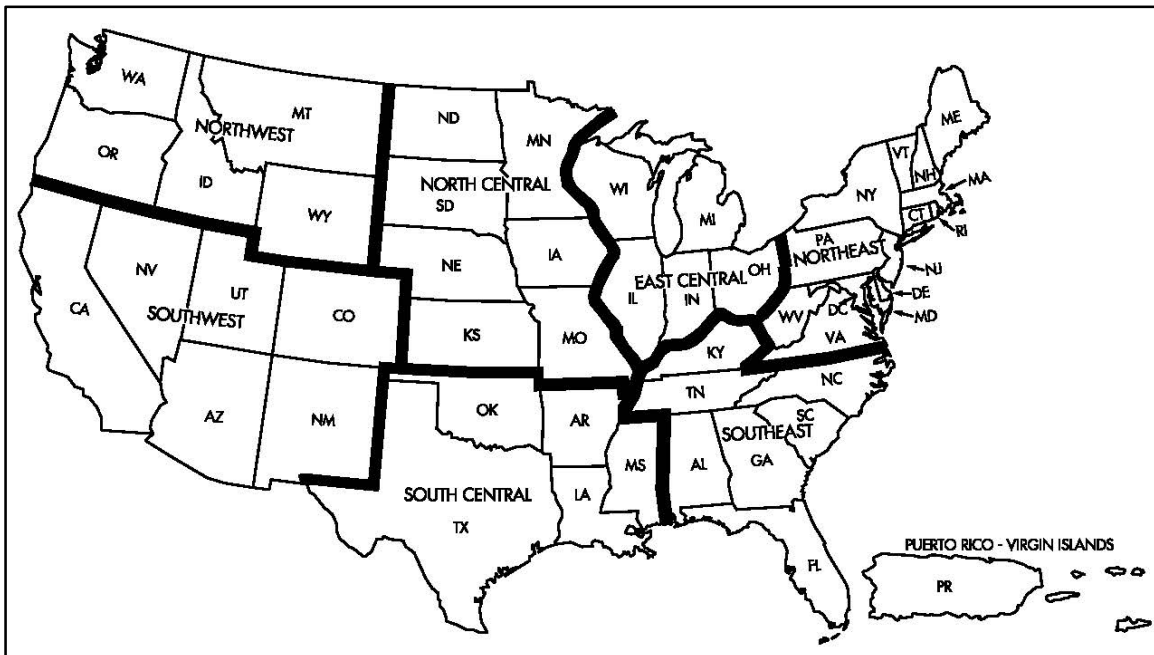
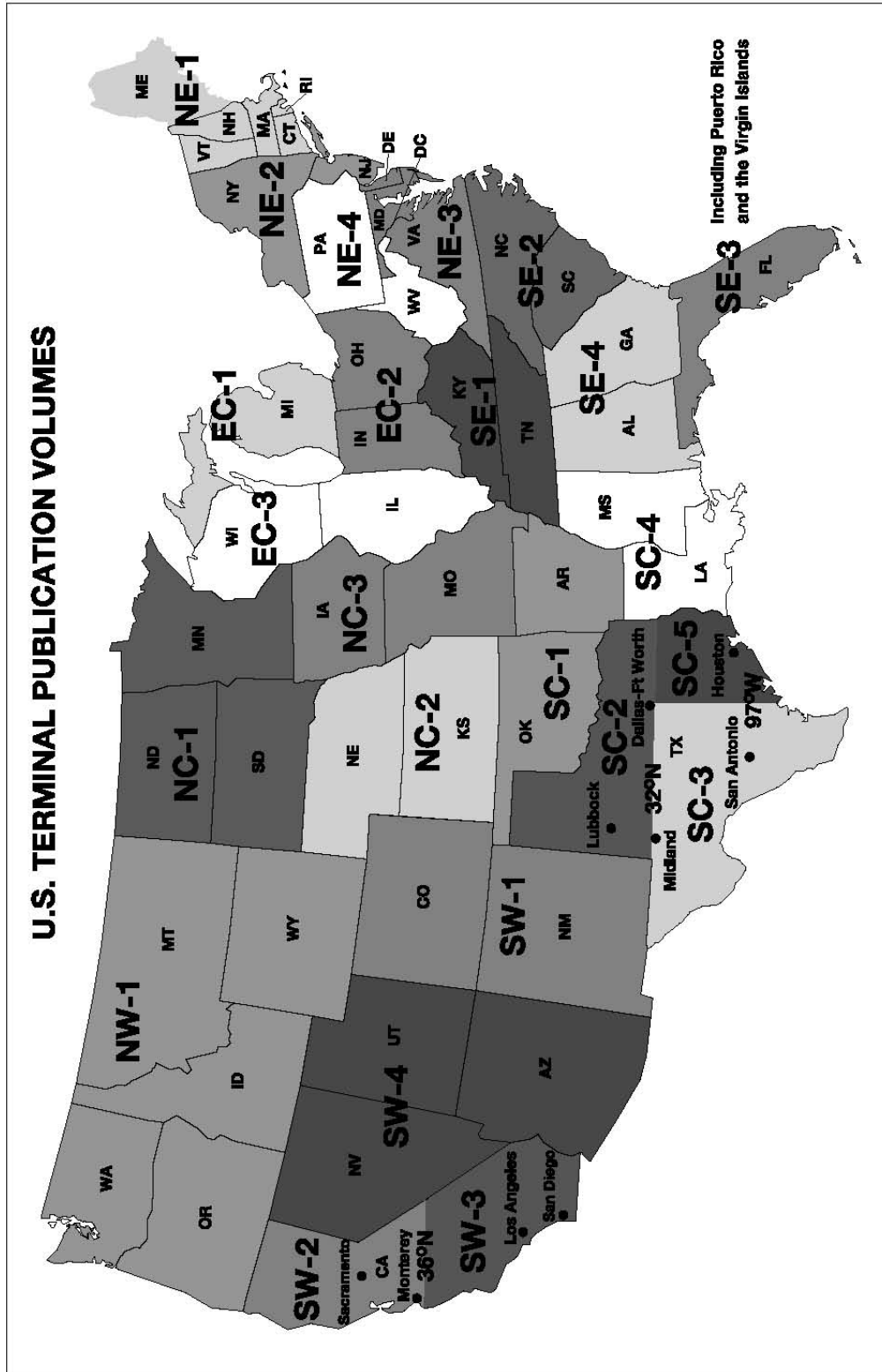

FIG 9-1-15
U.S. Terminal Publication Volumes



9-1-5. Where and How to Get Charts of Foreign Areas

a. National Geospatial-Intelligence Agency (NGA) Products. For the latest information regarding publication availability visit the NGA website: <https://www.nga.mil/ProductsServices/Pages/default.aspx>.

1. Flight Information Publication (FLIP) Planning Documents.

General Planning (GP)

Area Planning

Area Planning – Special Use Airspace – Planning Charts

2. FLIP En Route Charts and Chart Supplements.

Pacific, Australasia, and Antarctica

U.S. – IFR and VFR Supplements

Flight Information Handbook

Caribbean and South America – Low Altitude

Caribbean and South America – High Altitude

Europe, North Africa, and Middle East – Low Altitude

Europe, North Africa, and Middle East – High Altitude

Africa

Eastern Europe and Asia

Area Arrival Charts

3. FLIP Instrument Approach Procedures (IAPs).

Africa

Canada and North Atlantic

Caribbean and South America

Eastern Europe and Asia

Europe, North Africa, and Middle East

Pacific, Australasia, and Antarctica

VFR Arrival/Departure Routes – Europe and Korea

U.S.

4. Miscellaneous DOD Charts and Products.

Aeronautical Chart Updating Manual (CHUM)

DOD Weather Plotting Charts (WPC)

Tactical Pilotage Charts (TPC)

Operational Navigation Charts (ONC)

Global Navigation and Planning Charts (GNC)

Jet Navigation Charts (JNC) and Universal Jet Navigation Charts (JNU)

Jet Navigation Charts (JNCA)

Aerospace Planning Charts (ASC)

Oceanic Planning Charts (OPC)

Joint Operations Graphics – Air (JOG-A)

Standard Index Charts (SIC)

Universal Plotting Sheet (VP-OS)

Sight Reduction Tables for Air Navigation (PUB249)

Plotting Sheets (VP-30)

Dial-Up Electronic CHUM

b. Canadian Charts. Information on available Canadian charts and publications may be obtained by contacting the:

NAV CANADA

Aeronautical Publications

Sales and Distribution Unit

P.O. Box 9840, Station T

Ottawa, Ontario K1G 6S8 Canada

Telephone: 613-744-6393 or 1-866-731-7827

Fax: 613-744-7120 or 1-866-740-9992

c. Mexican Charts. Information on available Mexican charts and publications may be obtained by contacting:

Dirección de Navegacion Aereo

Blvd. Puerto Aereo 485

Zona Federal Del Aeropuerto Int'l

15620 Mexico D.F.

Mexico

d. International Civil Aviation Organization (ICAO). A free *ICAO Publications and Audio-Visual Training Aids Catalogue* is available from:

International Civil Aviation Organization

ATTN: Document Sales Unit

999 University Street

Montreal, Quebec

H3C 5H7, Canada

Telephone: (514) 954-8022

Fax: (514) 954-6769

E-mail: sales_unit@icao.org

Internet: <http://www.icao.org/cgi/goto.pl?icao/en/sales.htm>

Sitatex: YULCAYA

Telex: 05-24513

Chapter 10. Helicopter Operations

Section 1. Helicopter IFR Operations

10-1-1. Helicopter Flight Control Systems

a. The certification requirements for helicopters to operate under Instrument Flight Rules (IFR) are contained in 14 CFR Part 27, Airworthiness Standards: Normal Category Rotorcraft, and 14 CFR Part 29, Airworthiness Standards: Transport Category Rotorcraft. To meet these requirements, helicopter manufacturers usually utilize a set of stabilization and/or Automatic Flight Control Systems (AFCSs).

b. Typically, these systems fall into the following categories:

1. Aerodynamic surfaces, which impart some stability or control capability not found in the basic VFR configuration.

2. Trim systems, which provide a cyclic centering effect. These systems typically involve a magnetic brake/spring device, and may also be controlled by a four-way switch on the cyclic. This is a system that supports “hands on” flying of the helicopter by the pilot.

3. Stability Augmentation Systems (SASs), which provide short-term rate damping control inputs to increase helicopter stability. Like trim systems, SAS supports “hands on” flying.

4. Attitude Retention Systems (ATTs), which return the helicopter to a selected attitude after a disturbance. Changes in desired attitude can be accomplished usually through a four-way “beep” switch, or by actuating a “force trim” switch on the cyclic, setting the attitude manually, and releasing. Attitude retention may be a SAS function, or may be the basic “hands off” autopilot function.

5. Autopilot Systems (APs), which provide for “hands off” flight along specified lateral and vertical paths, including heading, altitude, vertical speed, navigation tracking, and approach. These systems

typically have a control panel for mode selection, and system for indication of mode status. Autopilots may or may not be installed with an associated Flight Director System (FD). Autopilots typically control the helicopter about the roll and pitch axes (cyclic control) but may also include yaw axis (pedal control) and collective control servos.

6. FDs, which provide visual guidance to the pilot to fly specific selected lateral and vertical modes of operation. The visual guidance is typically provided as either a “dual cue” (commonly known as a “cross-pointer”) or “single cue” (commonly known as a “vee-bar”) presentation superimposed over the attitude indicator. Some FDs also include a collective cue. The pilot manipulates the helicopter’s controls to satisfy these commands, yielding the desired flight path, or may couple the flight director to the autopilot to perform automatic flight along the desired flight path. Typically, flight director mode control and indication is shared with the autopilot.

c. In order to be certificated for IFR operation, a specific helicopter may require the use of one or more of these systems, in any combination.

d. In many cases, helicopters are certificated for IFR operations with either one or two pilots. Certain equipment is required to be installed and functional for two pilot operations, and typically, additional equipment is required for single pilot operation. These requirements are usually described in the limitations section of the Rotorcraft Flight Manual (RFM).

e. In addition, the RFM also typically defines systems and functions that are required to be in operation or engaged for IFR flight in either the single or two pilot configuration. Often, particularly in two pilot operation, this level of augmentation is less than the full capability of the installed systems. Likewise, single pilot operation may require a higher level of augmentation.

f. The RFM also identifies other specific limitations associated with IFR flight. Typically, these limitations include, but are not limited to:

1. Minimum equipment required for IFR flight (in some cases, for both single pilot and two pilot operations).

2. V_{mini} (minimum speed – IFR).

NOTE–

The manufacturer may also recommend a minimum IFR airspeed during instrument approach.

3. V_{nei} (never exceed speed – IFR).

4. Maximum approach angle.

5. Weight and center of gravity limits.

6. Aircraft configuration limitations (such as aircraft door positions and external loads).

7. Aircraft system limitations (generators, inverters, etc.).

8. System testing requirements (many avionics and AFCS/AP/FD systems incorporate a self-test feature).

9. Pilot action requirements (such as the pilot must have his/her hands and feet on the controls during certain operations, such as during instrument approach below certain altitudes).

g. It is very important that pilots be familiar with the IFR requirements for their particular helicopter. Within the same make, model and series of helicopter, variations in the installed avionics may change the required equipment or the level of augmentation for a particular operation.

h. During flight operations, pilots must be aware of the mode of operation of the augmentation systems, and the control logic and functions employed. For example, during an ILS approach using a particular system in the three-cue mode (lateral, vertical and collective cues), the flight

director *collective cue* responds to glideslope deviation, while the horizontal bar of the “cross-pointer” responds to airspeed deviations. The same system, while flying an ILS in the two-cue mode, provides for the *horizontal bar* to respond to glideslope deviations. This concern is particularly significant when operating using two pilots. Pilots should have an established set of procedures and responsibilities for the control of flight director/auto-pilot modes for the various phases of flight. Not only does a full understanding of the system modes provide for a higher degree of accuracy in control of the helicopter, it is the basis for crew identification of a faulty system.

i. Relief from the prohibition to takeoff with any inoperative instruments or equipment may be provided through a Minimum Equipment List (see 14 CFR Section 91.213 and 14 CFR Section 135.179, Inoperative Instruments and Equipment). In many cases, a helicopter configured for single pilot IFR may depart IFR with certain equipment inoperative, provided a crew of two pilots is used. Pilots are cautioned to ensure the pilot-in-command and second-in-command meet the requirements of 14 CFR Section 61.58, Pilot-in-Command Proficiency Check: Operation of Aircraft Requiring More Than One Pilot Flight Crewmember, and 14 CFR Section 61.55, Second-in-Command Qualifications, or 14 CFR Part 135, Operating Requirements: Commuter and On-Demand Operations, Subpart E, Flight Crewmember Requirements, and Subpart G, Crewmember Testing Requirements, as appropriate.

j. Experience has shown that modern AFCS/AP/FD equipment installed in IFR helicopters can, in some cases, be very complex. This complexity requires the pilot(s) to obtain and maintain a high level of knowledge of system operation, limitations, failure indications and reversionary modes. In some cases, this may only be reliably accomplished through formal training.

10-1-2. Helicopter Instrument Approaches

a. Helicopters are capable of flying any published 14 CFR Part 97, Standard Instrument Approach Procedures (SIAPs), for which they are properly equipped, subject to the following limitations and conditions:

1. Helicopters flying conventional (non-Copter) SIAPs may reduce the visibility minima to not less than one half the published Category A landing visibility minima, or $\frac{1}{4}$ statute mile visibility/1200 RVR, whichever is greater unless the procedure is annotated with “**Visibility Reduction by Helicopters NA.**” This annotation means that there are penetrations of the final approach obstacle identification surface (OIS) and that the 14 CFR Section 97.3 visibility reduction rule does not apply and you must take precaution to avoid any obstacles in the visual segment. No reduction in MDA/DA is permitted. The helicopter may initiate the final approach segment at speeds up to the upper limit of the highest approach category authorized by the procedure, but must be slowed to no more than 90 KIAS at the missed approach point (MAP) in order to apply the visibility reduction. Pilots are cautioned that such a decelerating approach may make early identification of wind shear on the approach path difficult or impossible. If required, use the Inoperative Components and Visual Aids Table provided in the front cover of the U.S. Terminal Procedures Volume to derive the Category A minima before applying the 14 CFR Section 97.3(d-1) rule.

2. Helicopters flying Copter SIAPs may use the published minima, with no reductions allowed. The maximum airspeed is 90 KIAS on any segment of the approach or missed approach.

3. Helicopters flying GPS Copter SIAPs must limit airspeed to 90 KIAS or less when flying any segment of the procedure, except speeds must be limited to no more than 70 KIAS on the final and missed approach segments. Military GPS Copter SIAPs are limited to no more than 90 KIAS throughout the procedure. If annotated, holding may

also be limited to no more than 70 KIAS. Use the published minima, no reductions allowed.

NOTE-

Obstruction clearance surfaces are based on the aircraft speed and have been designed on these approaches for 70 knots. If the helicopter is flown at higher speeds, it may fly outside of protected airspace. Some helicopters have a V_{MINI} greater than 70 knots; therefore, they cannot meet the 70 knot limitation to conduct this type of procedure. Some helicopter autopilots, when used in the “go-around” mode, are programmed with a V_{YI} greater than 70 knots, therefore when using the autopilot “go-around” mode, they cannot meet the 70 knot limitation to conduct this type of approach. It may be possible to use the autopilot for the missed approach in the other than the “go-around” mode and meet the 70 knot limitation to conduct this type of approach. When operating at speeds other than V_{YI} or V_Y , performance data may not be available in the RFM to predict compliance with climb gradient requirements. Pilots may use observed performance in similar weight/altitude/temperature/speed conditions to evaluate the suitability of performance. Pilots are cautioned to monitor climb performance to ensure compliance with procedure requirements.

4. TBL 10-1-1 summarizes these requirements.

5. Even with weather conditions reported at or above landing minima, some combinations of reduced cockpit cutoff angle, minimal approach/runway lighting, and high MDA/DH coupled with a low visibility minima, the pilot may not be able to identify the required visual reference(s) during the approach, or those references may only be visible in a very small portion of the pilot’s available field of view. Even if identified by the pilot, these visual references may not support normal maneuvering and normal rates of descent to landing. The effect of such a combination may be exacerbated by other conditions such as rain on the windshield, or incomplete windshield defogging coverage.

6. Pilots are cautioned to be prepared to execute a missed approach even though weather conditions may be reported at or above landing minima.

NOTE-

See paragraph 5-4-21, Missed Approach, for additional information on missed approach procedures.

TBL 10-1-1

Helicopter Use of Standard Instrument Approach Procedures

Procedure	Helicopter Visibility Minima	Helicopter MDA/DA	Maximum Speed Limitations
Conventional (non-Copter)	The greater of: one half the Category A visibility minima, $\frac{1}{4}$ statute mile visibility, or 1200 RVR	As published for Category A	The helicopter may initiate the final approach segment at speeds up to the upper limit of the highest Approach Category authorized by the procedure, but must be slowed to no more than 90 KIAS at the MAP in order to apply the visibility reduction.
Copter Procedure	As published	As published	90 KIAS when on a published route/track.
GPS Copter Procedure	As published	As published	90 KIAS when on a published route or track, EXCEPT 70 KIAS when on the final approach or missed approach segment and, if annotated, in holding. Military procedures are limited to 90 KIAS for all segments.

NOTE-

Several factors affect the ability of the pilot to acquire and maintain the visual references specified in 14 CFR Section 91.175(c), even in cases where the flight visibility may be at the minimum derived by TBL 10-1-1. These factors include, but are not limited to:

1. Cockpit cutoff angle (the angle at which the cockpit or other airframe structure limits downward visibility below the horizon).

2. Combinations of high MDA/DH and low visibility minimum, such as a conventional nonprecision approach with a reduced helicopter visibility minima (per 14 CFR Section 97.3).

3. Type, configuration, and intensity of approach and runway lighting systems.

4. Type of obscuring phenomenon and/or windshield contamination.

10-1-3. Helicopter Approach Procedures to VFR Heliports

a. Helicopter approaches may be developed for heliports that do not meet the design standards for an IFR heliport. The majority of IFR approaches to VFR heliports are developed in support of helicopter emergency medical services (HEMS) operators. These approaches can be developed from conventional NAVAIDs or a RNAV system (including GPS). They are developed either as a Special Approach (pilot training is required for special procedures due to their unique characteristics) or a public approach (no special training required). These instrument procedures are developed as either an approach designed to a specific landing site, or an approach designed to a point-in-space.

1. Approach to a specific landing site. The approach is aligned to a missed approach point from which a landing can be accomplished with a maximum course change of 30 degrees. The visual segment from the MAP to the landing site is evaluated for obstacle hazards. These procedures are annotated: “PROCEED VISUALLY FROM (NAMED MAP) OR CONDUCT THE SPECIFIED MISSED APPROACH.”

(a) This phrase requires the pilot to either acquire and maintain visual contact with the landing site at or prior to the MAP, or execute a missed approach. The visibility minimum is based on the distance from the MAP to the landing site, among other factors.

(b) The pilot is required to maintain the published minimum visibility throughout the visual segment.

(c) Similar to an approach to a runway, the missed approach segment protection is not provided between the MAP and the landing site, and obstacle or terrain avoidance from the MAP to the landing site is the responsibility of the pilot.

(d) Upon reaching the MAP defined on the approach procedure, or as soon as practicable after reaching the MAP, the pilot advises ATC whether proceeding visually and canceling IFR or complying with the missed approach instructions. See paragraph 5-1-15, Canceling IFR Flight Plan.

(e) At least one of the following visual references must be visible or identifiable before the pilot may proceed visually:

- (1) FATO or FATO lights.
- (2) TLOF or TLOF lights.
- (3) Heliport Instrument Lighting System (HILS).
- (4) Heliport Approach Lighting System (HALS) or lead-in lights.
- (5) Visual Glideslope Indicator (VGSI).
- (6) Windsock or windsock light(s). See note below.
- (7) Heliport beacon. See note below.
- (8) Other facilities or systems approved by the Flight Technologies and Procedures Division (AFS-400).

NOTE-

Windsock lights and heliport beacons should be located within 500 ft of the TLOF.

2. Approach to a Point-in-Space (PinS). At locations where the MAP is located more than 2 SM from the landing site, or the path from the MAP to the landing site is populated with obstructions which require avoidance actions or requires turns greater than 30 degrees, a PinS procedure may be developed. These approaches are annotated “PROCEED VFR FROM (NAMED MAP) OR CONDUCT THE SPECIFIED MISSED APPROACH.”

(a) These procedures require the pilot, at or prior to the MAP, to determine if the published minimum visibility, or the weather minimums required by the operating rule, or operations specifications (whichever is higher) is available to safely transition from IFR to VFR flight. If not, the pilot must execute a missed approach. For Part 135 operations, pilots may not begin the instrument approach unless the latest weather report indicates that the weather conditions are at or above the authorized IFR minimums or the VFR weather minimums (as required by the class of airspace, operating rule and/or Operations Specifications) whichever is higher.

(b) Visual contact with the landing site is not required; however, the pilot must maintain the appropriate VFR weather minimums throughout the visual segment. The visibility is limited to no lower

than that published in the procedure, until canceling IFR.

(c) IFR obstruction clearance areas are not applied to the VFR segment between the MAP and the landing site. Obstacle or terrain avoidance from the MAP to the landing site is the responsibility of the pilot.

(d) Upon reaching the MAP defined on the approach procedure, or as soon as practicable after reaching the MAP, the pilot advises ATC whether proceeding VFR and canceling IFR, or complying with the missed approach instructions. See paragraph 5-1-15, Canceling IFR Flight Plan.

(e) If the visual segment penetrates Class B, C, or D airspace, pilots are responsible for obtaining a Special VFR clearance, when required.

10-1-4. The Gulf of Mexico Grid System

a. On October 8, 1998, the Southwest Regional Office of the FAA, with assistance from the Helicopter Safety Advisory Conference (HSAC), implemented the world's first Instrument Flight Rules (IFR) Grid System in the Gulf of Mexico. This navigational route structure is completely independent of ground-based navigation aids (NAVAIDs) and was designed to facilitate helicopter IFR operations to offshore destinations. The Grid System is defined by over 300 offshore waypoints located 20 minutes apart (latitude and longitude). Flight plan routes are routinely defined by just 4 segments: departure point (lat/long), first en route grid waypoint, last en route grid waypoint prior to approach procedure, and destination point (lat/long). There are over 4,000 possible offshore landing sites. Upon reaching the waypoint prior to the destination, the pilot may execute an Offshore Standard Approach Procedure (OSAP), a Helicopter En Route Descent Areas (HEDA) approach, or an Airborne Radar Approach (ARA). For more information on these helicopter instrument procedures, refer to FAA AC 90-80B, Approval of Offshore Standard Approach Procedures, Airborne Radar Approaches, and Helicopter En Route Descent Areas, on the FAA website <http://www.faa.gov> under Advisory Circulars. The return flight plan is just the reverse with the requested stand-alone GPS approach contained in the remarks section.

1. The large number (over 300) of waypoints in the grid system makes it difficult to assign phonetically pronounceable names to the waypoints that would be meaningful to pilots and controllers. A unique naming system was adopted that enables pilots and controllers to derive the fix position from the name. The five-letter names are derived as follows:

(a) The waypoints are divided into sets of 3 columns each. A three-letter identifier, identifying a geographical area or a NAVAID to the north, represents each set.

(b) Each column in a set is named after its position, i.e., left (L), center (C), and right (R).

(c) The rows of the grid are named alphabetically from north to south, starting with A for the northern most row.

EXAMPLE-

LCHRC would be pronounced "Lake Charles Romeo Charlie." The waypoint is in the right-hand column of the Lake Charles VOR set, in row C (third south from the northern most row).

2. In December 2009, significant improvements to the Gulf of Mexico grid system were realized with the introduction of ATC separation services using ADS-B. In cooperation with the oil and gas services industry, HSAC and Helicopter Association International (HAI), the FAA installed an infrastructure of ADS-B ground stations, weather stations (AWOS) and VHF remote communication outlets (RCO) throughout a large area of the Gulf of Mexico. This infrastructure allows the FAA's Houston ARTCC to provide "domestic-like" air traffic control service in the offshore area beyond 12nm from the coastline to hundreds of miles offshore to aircraft equipped with ADS-B. Properly equipped aircraft can now be authorized to receive more direct routing, domestic en route separation minima and real time flight following. Operators who do not have authorization to receive ATC separation services using ADS-B, will continue to use the low altitude grid system and receive procedural separation from Houston ARTCC. Non-ADS-B equipped aircraft also benefit from improved VHF communication and expanded weather information coverage.

3. Three requirements must be met for operators to file IFR flight plans utilizing the grid:

(a) The helicopter must be equipped for IFR operations and equipped with IFR approved GPS navigational units.

(b) The operator must obtain prior written approval from the appropriate Flight Standards District Office through a Letter of Authorization or Operations Specification, as appropriate.

(c) The operator must be a signatory to the Houston ARTCC Letter of Agreement.

4. Operators who wish to benefit from ADS-B based ATC separation services must meet the following additional requirements:

(a) The Operator's installed ADS-B Out equipment must meet the performance requirements of one of the following FAA Technical Standard Orders (TSO), or later revisions: TSO-C154c, Universal Access Transceiver (UAT) Automatic Dependent Surveillance-Broadcast (ADS-B) Equip-

ment, or TSO-C166b, Extended Squitter Automatic Dependent Surveillance-Broadcast (ADS-B) and Traffic Information.

(b) Flight crews must comply with the procedures prescribed in the Houston ARTCC Letter of Agreement dated December 17, 2009, or later.

NOTE-

The unique ADS-B architecture in the Gulf of Mexico depends upon reception of an aircraft's Mode C in addition to the other message elements described in 14 CFR 91.227. Flight crews must be made aware that loss of Mode C also means that ATC will not receive the aircraft's ADS-B signal.

5. FAA/AIS publishes the grid system waypoints on the IFR Gulf of Mexico Vertical Flight Reference Chart. A commercial equivalent is also available. The chart is updated annually and is available from an FAA approved print provider or FAA directly, website address: http://www.faa.gov/air_traffic/flight_info/aeronav.

Section 2. Special Operations

10–2–1. Offshore Helicopter Operations

a. Introduction

The offshore environment offers unique applications and challenges for helicopter pilots. The mission demands, the nature of oil and gas exploration and production facilities, and the flight environment (weather, terrain, obstacles, traffic), demand special practices, techniques and procedures not found in other flight operations. Several industry organizations have risen to the task of reducing risks in offshore operations, including the Helicopter Safety Advisory Conference (HSAC) (<http://www.hsac.org>), and the Offshore Committee of the Helicopter Association International (HAI) (<http://www.rotor.com>). The following recommended practices for offshore helicopter operations are based on guidance developed by HSAC for use in the Gulf of Mexico, and provided here with their permission. While not regulatory, these recommended practices provide aviation and oil and gas industry operators with useful information in developing procedures to avoid certain hazards of offshore helicopter operations.

NOTE–

Like all aviation practices, these recommended practices are under constant review. In addition to normal procedures for comments, suggested changes, or corrections to the AIM (contained in the Preface), any questions or feedback concerning these recommended procedures may also be directed to the HSAC through the feedback feature of the HSAC website (<http://www.hsac.org>).

b. Passenger Management on and about Heliport Facilities

1. Background. Several incidents involving offshore helicopter passengers have highlighted the potential for incidents and accidents on and about the heliport area. The following practices will minimize risks to passengers and others involved in heliport operations.

2. Recommended Practices

(a) Heliport facilities should have a designated and posted passenger waiting area which is clear of the heliport, heliport access points, and stairways.

(b) Arriving passengers and cargo should be unloaded and cleared from the heliport and access route prior to loading departing passengers and cargo.

(c) Where a flight crew consists of more than one pilot, one crewmember should supervise the unloading/loading process from outside the aircraft.

(d) Where practical, a designated facility employee should assist with loading/unloading, etc.

c. Crane–Helicopter Operational Procedures

1. Background. Historical experience has shown that catastrophic consequences can occur when industry safe practices for crane/helicopter operations are not observed. The following recommended practices are designed to minimize risks during crane and helicopter operations.

2. Recommended Practices

(a) Personnel awareness

(1) Crane operators and pilots should develop a mutual understanding and respect of the others' operational limitations and cooperate in the spirit of safety;

(2) Pilots need to be aware that crane operators sometimes cannot release the load to cradle the crane boom, such as when attached to wire line lubricators or supporting diving bells; and

(3) Crane operators need to be aware that helicopters require warm up before takeoff, a two–minute cool down before shutdown, and cannot circle for extended lengths of time because of fuel consumption.

(b) It is recommended that when helicopters are approaching, maneuvering, taking off, or running on the heliport, cranes be shutdown and the operator leave the cab. Cranes not in use must have their booms cradled, if feasible. If in use, the crane's boom(s) are to be pointed away from the heliport and the crane shutdown for helicopter operations.

(c) Pilots will not approach, land on, takeoff, or have rotor blades turning on heliports of structures not complying with the above practice.

(d) It is recommended that cranes on offshore platforms, rigs, vessels, or any other facility, which could interfere with helicopter operations (including approach/departure paths):

(1) Be equipped with a red rotating beacon or red high intensity strobe light connected to the system powering the crane, indicating the crane is under power;

(2) Be designed to allow the operator a maximum view of the helideck area and should be equipped with wide-angle mirrors to eliminate blind spots; and

(3) Have their boom tips, headache balls, and hooks painted with high visibility international orange.

d. Helicopter/Tanker Operations

1. Background. The interface of helicopters and tankers during shipboard helicopter operations is complex and may be hazardous unless appropriate procedures are coordinated among all parties. The following recommended practices are designed to minimize risks during helicopter/tanker operations:

2. Recommended Practices

(a) Management, flight operations personnel, and pilots should be familiar with and apply the operating safety standards set forth in “Guide to Helicopter/Ship Operations”, International Chamber of Shipping, Third Edition, 5–89 (as amended), establishing operational guidelines/standards and safe practices sufficient to safeguard helicopter/tanker operations.

(b) Appropriate plans, approvals, and communications must be accomplished prior to reaching the vessel, allowing tanker crews sufficient time to perform required safety preparations and position crew members to receive or dispatch a helicopter safely.

(c) Appropriate approvals and direct communications with the bridge of the tanker must be maintained throughout all helicopter/tanker operations.

(d) Helicopter/tanker operations, including landings/departures, must not be conducted until the helicopter pilot-in-command has received and acknowledged permission from the bridge of the tanker.

(e) Helicopter/tanker operations must not be conducted during product/cargo transfer.

(f) Generally, permission will not be granted to land on tankers during mooring operations or while maneuvering alongside another tanker.

e. Helideck/Heliport Operational Hazard Warning(s) Procedures

1. Background

(a) A number of operational hazards can develop on or near offshore helidecks or onshore heliports that can be minimized through procedures for proper notification or visual warning to pilots. Examples of hazards include but are not limited to:

(1) Perforating operations: subparagraph f.

(2) H₂S gas presence: subparagraph g.

(3) Gas venting: subparagraph h; or,

(4) Closed helidecks or heliports: subparagraph i (unspecified cause).

(b) These and other operational hazards are currently minimized through timely dissemination of a written Notice to Airmen (NOTAM) for pilots by helicopter companies and operators. A NOTAM provides a written description of the hazard, time and duration of occurrence, and other pertinent information. ANY POTENTIAL HAZARD should be communicated to helicopter operators or company aviation departments as early as possible to allow the NOTAM to be activated.

(c) To supplement the existing NOTAM procedure and further assist in reducing these hazards, a standardized visual signal(s) on the helideck/heliport will provide a positive indication to an approaching helicopter of the status of the landing area. Recommended Practice(s) have been developed to reinforce the NOTAM procedures and standardize visual signals.

f. Drilling Rig Perforating Operations: Helideck/Heliport Operational Hazard Warning(s)/Procedure(s)

1. Background. A critical step in the oil well completion process is perforation, which involves the use of explosive charges in the drill pipe to open the pipe to oil or gas deposits. Explosive charges used in conjunction with perforation operations offshore can potentially be prematurely detonated by radio

transmissions, including those from helicopters. The following practices are recommended.

2. Recommended Practices

(a) Personnel Conducting Perforating Operations. Whenever perforating operations are scheduled and operators are concerned that radio transmissions from helicopters in the vicinity may jeopardize the operation, personnel conducting perforating operations should take the following precautionary measures:

(1) Notify company aviation departments, helicopter operators or bases, and nearby manned platforms of the pending perforation operation so the Notice to Airmen (NOTAM) system can be activated for the perforation operation and the temporary helideck closure.

(2) Close the deck and make the radio warning clearly visible to passing pilots, install a temporary marking (described in subparagraph 10-2-1i1(b)) with the words “NO RADIO” stenciled in red on the legs of the diagonals. The letters should be 24 inches high and 12 inches wide. (See FIG 10-2-1.)

(3) The marker should be installed during the time that charges may be affected by radio transmissions.

(b) Pilots

(1) Pilots when operating within 1,000 feet of a known perforation operation or observing the white X with red “NO RADIO” warning indicating perforation operations are underway will avoid radio transmissions from or near the helideck (within 1,000 feet) and will not land on the deck if the X is present. In addition to communications radios, radio transmissions are also emitted by aircraft radar,

transponders, radar altimeters, and DME equipment, and ELTs.

(2) Whenever possible, make radio calls to the platform being approached or to the Flight Following Communications Center at least one mile out on approach. Ensure all communications are complete outside the 1,000 foot hazard distance. If no response is received, or if the platform is not radio equipped, further radio transmissions should not be made until visual contact with the deck indicates it is open for operation (no white “X”).

g. Hydrogen Sulfide Gas Helideck/Heliport Operational Hazard Warning(s)/Procedures

1. Background. Hydrogen sulfide (H₂S) gas: Hydrogen sulfide gas in higher concentrations (300–500 ppm) can cause loss of consciousness within a few seconds and presents a hazard to pilots on/near offshore helidecks. When operating in offshore areas that have been identified to have concentrations of hydrogen sulfide gas, the following practices are recommended.

2. Recommended Practices

(a) Pilots

(1) Ensure approved protective air packs are available for emergency use by the crew on the helicopter.

(2) If shutdown on a helideck, request the supervisor in charge provide a briefing on location of protective equipment and safety procedures.

(3) If while flying near a helideck and the visual red beacon alarm is observed or an unusually strong odor of “rotten eggs” is detected, immediately don the protective air pack, exit to an area upwind, and notify the suspected source field of the hazard.

FIG 10-2-1
Closed Helideck Marking – No Radio

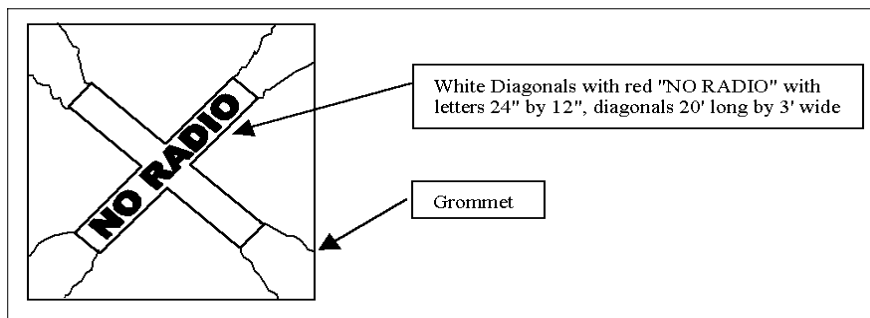

(b) Oil Field Supervisors

(1) If presence of hydrogen sulfide is detected, a red rotating beacon or red high intensity strobe light adjacent to the primary helideck stairwell or wind indicator on the structure should be turned on to provide visual warning of hazard. If the beacon is to be located near the stairwell, the State of Louisiana “Offshore Heliport Design Guide” and FAA Advisory Circular (AC) 150/5390–2A, Heliport Design Guide, should be reviewed to ensure proper clearance on the helideck.

(2) Notify nearby helicopter operators and bases of the hazard and advise when hazard is cleared.

(3) Provide a safety briefing to include location of protective equipment to all arriving personnel.

(4) Wind socks or indicator should be clearly visible to provide upwind indication for the pilot.

h. Gas Venting Helideck/Heliport Operational Hazard Warning(s)/Procedures – Operations Near Gas Vent Booms

1. Background. Ignited flare booms can release a large volume of natural gas and create a hot fire and intense heat with little time for the pilot to react. Likewise, unignited gas vents can release reasonably large volumes of methane gas under certain conditions. Thus, operations conducted very near unignited gas vents require precautions to prevent inadvertent ingestion of combustible gases by the helicopter engine(s). The following practices are recommended.

2. Pilots

(a) Gas will drift upwards and downwind of the vent. Plan the approach and takeoff to observe and avoid the area downwind of the vent, remaining as far away as practicable from the open end of the vent boom.

(b) Do not attempt to start or land on an offshore helideck when the deck is downwind of a gas vent unless properly trained personnel verify conditions are safe.

3. Oil Field Supervisors

(a) During venting of large amounts of unignited raw gas, a red rotating beacon or red high intensity strobe light adjacent to the primary helideck stairwell or wind indicator should be turned on to provide visible warning of hazard. If the beacon is to be located near the stairwell, the State of Louisiana “Offshore Heliport Design Guide” and FAA AC 150/5390–2A, Heliport Design Guide, should be reviewed to ensure proper clearance from the helideck.

(b) Notify nearby helicopter operators and bases of the hazard for planned operations.

(c) Wind socks or indicator should be clearly visible to provide upward indication for the pilot.

i. Helideck/Heliport Operational Warning(s)/Procedure(s) – Closed Helidecks or Heliports

1. Background. A white “X” marked diagonally from corner to corner across a helideck or heliport touchdown area is the universally accepted visual indicator that the landing area is closed for safety of other reasons and that helicopter operations are not permitted. The following practices are recommended.

(a) **Permanent Closing.** If a helideck or heliport is to be permanently closed, X diagonals of the same size and location as indicated above should be used, but the markings should be painted on the landing area.

NOTE–

White Decks: If a helideck is painted white, then international orange or yellow markings can be used for the temporary or permanent diagonals.

(b) **Temporary Closing.** A temporary marker can be used for hazards of an interim nature. This marker could be made from vinyl or other durable material in the shape of a diagonal “X.” The marker should be white with legs at least 20 feet long and 3 feet in width. This marker is designed to be quickly secured and removed from the deck using grommets and rope ties. The duration, time, location, and nature of these temporary closings should be provided to and coordinated with company aviation departments, nearby helicopter bases, and helicopter operators supporting the area. These markers **MUST** be removed when the hazard no longer exists.

(See FIG 10–2–2.)

FIG 10-2-2
Closed Helideck Marking

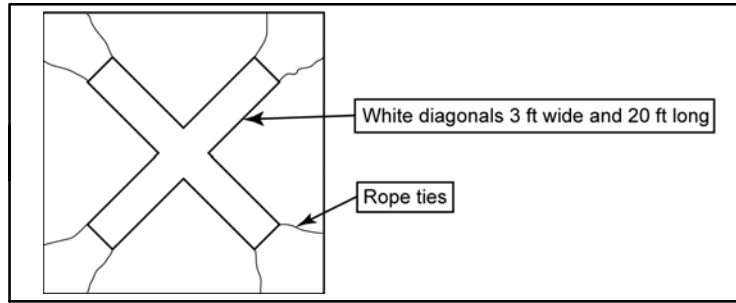

j. Offshore (VFR) Operating Altitudes for Helicopters

1. Background. Mid-air collisions constitute a significant percentage of total fatal offshore helicopter accidents. A method of reducing this risk is the use of coordinated VFR cruising altitudes. To enhance safety through standardized vertical separation of helicopters when flying in the offshore environment, it is recommended that helicopter operators flying in a particular area establish a cooperatively developed Standard Operating Procedure (SOP) for VFR operating altitudes. An example of such an SOP is contained in this example.

2. Recommended Practice Example

(a) Field Operations. Without compromising minimum safe operating altitudes, helicopters working within an offshore field “constituting a cluster” should use altitudes not to exceed 500 feet.

(b) En Route Operations

(1) Helicopters operating below 750’ AGL should avoid transitioning through offshore fields.

(2) Helicopters en route to and from offshore locations, below 3,000 feet, weather permitting, should use en route altitudes as outlined in TBL 10-2-1.

TBL 10-2-1

Magnetic Heading	Altitude
0° to 179°	750’
	1750’
	2750’
180° 359°	1250’
	2250’

(c) Area Agreements. See HSAC Area Agreement Maps for operating procedures for onshore high density traffic locations.

NOTE-
Pilots of helicopters operating VFR above 3,000 feet above the surface should refer to the current Federal Aviation Regulations (14 CFR Part 91), and paragraph 3-1-4, Basic VFR Weather Minimums, of the AIM.

(d) Landing Lights. Aircraft landing lights should be on to enhance aircraft identification:

- (1)** During takeoff and landings;
- (2)** In congested helicopter or fixed wing traffic areas;
- (3)** During reduced visibility; or,
- (4)** Anytime safety could be enhanced.

k. Offshore Helidecks/Landing Communications

1. Background. To enhance safety, and provide appropriate time to prepare for helicopter operations, the following is recommended when anticipating a landing on an offshore helideck.

2. Recommended Practices

(a) Before landing on an offshore helideck, pilots are encouraged to establish communications with the company owning or operating the helideck if frequencies exist for that purpose.

(b) When impracticable, or if frequencies do not exist, pilots or operations personnel should attempt to contact the company owning or operating the helideck by telephone. Contact should be made before the pilot departs home base/point of departure to advise of intentions and obtain landing permission if necessary.

NOTE—

It is recommended that communications be established a minimum of 10 minutes prior to planned arrival time. This practice may be a requirement of some offshore owner/operators.

NOTE—

1. See subparagraph 10-2-1d for Tanker Operations.
2. Private use Heliport. Offshore heliports are privately owned/operated facilities and their use is limited to persons having prior authorization to utilize the facility.

1. Two (2) Helicopter Operations on Offshore Helidecks

1. Background. Standardized procedures can enhance the safety of operating a second helicopter on an offshore helideck, enabling pilots to determine/maintain minimum operational parameters. Orientation of the parked helicopter on the helideck, wind and other factors may prohibit multi-helicopter operations. More conservative Rotor Diameter (RD) clearances may be required under differing condition, i.e., temperature, wet deck, wind (velocity/direction/gusts), obstacles, approach/departure angles, etc. Operations are at the pilot's discretion.

2. Recommended Practice. Helideck size, structural weight capability, and type of main rotor on the parked and operating helicopter will aid in determining accessibility by a second helicopter. Pilots should determine that multi-helicopter deck operations are permitted by the helideck owner/operator.

3. Recommended Criteria

(a) Minimum one-third rotor diameter clearance ($\frac{1}{3}$ RD). The landing helicopter maintains a minimum $\frac{1}{3}$ RD clearance between the tips of its turning rotor and the closest part of a parked and secured helicopter (rotors stopped and tied down).

(b) Three foot parking distance from deck edge (3'). Helicopters operating on an offshore helideck land or park the helicopter with a skid/wheel assembly no closer than 3 feet from helideck edge.

(c) Tiedowns. Main rotors on all helicopters that are shut down be properly secured (tied down) to prevent the rotor blades from turning.

(d) Medium (transport) and larger helicopters should not land on any offshore helideck where a light

helicopter is parked unless the light helicopter is property secured to the helideck and has main rotor tied down.

(e) Helideck owners/operators should ensure that the helideck has a serviceable anti-skid surface.

4. Weight and limitations markings on helideck. The helideck weight limitations should be displayed by markings visible to the pilot (see State of Louisiana "Offshore Heliport Design Guide" and FAA AC 150/5390-2A, Heliport Design Guide).

NOTE—

Some offshore helideck owners/operators have restrictions on the number of helicopters allowed on a helideck. When helideck size permits, multiple (more than two) helicopter operations are permitted by some operators.

m. Helicopter Rapid Refueling Procedures (HRR)

1. Background. Helicopter Rapid Refueling (HRR), engine(s)/rotors operating, can be conducted safely when utilizing trained personnel and observing safe practices. This recommended practice provides minimum guidance for HRR as outlined in National Fire Protection Association (NFPA) and industry practices. For detailed guidance, please refer to National Fire Protection Association (NFPA) Document 407, "Standard for Aircraft Fuel Servicing," 1990 edition, including 1993 HRR Amendment.

NOTE—

Certain operators prohibit HRR, or "hot refueling," or may have specific procedures for certain aircraft or refueling locations. See the General Operations Manual and/or Operations Specifications to determine the applicable procedures or limitations.

2. Recommended Practices

(a) Only turbine-engine helicopters fueled with JET A or JET A-1 with fueling ports located below any engine exhausts may be fueled while an onboard engine(s) is (are) operating.

(b) Helicopter fueling while an onboard engine(s) is (are) operating should only be conducted under the following conditions:

(1) A properly certificated and current pilot is at the controls and a trained refueler attending the fuel nozzle during the entire fuel servicing process. The pilot monitors the fuel quantity and signals the refueler when quantity is reached.

(2) No electrical storms (thunderstorms) are present within 10 nautical miles. Lightning can travel great distances beyond the actual thunderstorm.

(3) Passengers disembark the helicopter and move to a safe location prior to HRR operations. When the pilot-in-command deems it necessary for passenger safety that they remain onboard, passengers should be briefed on the evacuation route to follow to clear the area.

(4) Passengers not board or disembark during HRR operations nor should cargo be loaded or unloaded.

(5) Only designated personnel, trained in HRR operations should conduct HRR written authorization to include safe handling of the fuel and equipment. (See your Company Operations/Safety Manual for detailed instructions.)

(6) All doors, windows, and access points allowing entry to the interior of the helicopter that are adjacent to or in the immediate vicinity of the fuel inlet ports kept closed during HRR operations.

(7) Pilots ensure that appropriate electrical/electronic equipment is placed in standby-off position, to preclude the possibility of electrical discharge or other fire hazard, such as [i.e., weather radar is on standby and no radio transmissions are made (keying of the microphone/transmitter)]. Remember, in addition to communications radios, radio transmissions are also emitted by aircraft radar, transponders, radar altimeters, DME equipment, and ELTs.

(8) Smoking be prohibited in and around the helicopter during all HRR operations.

The HRR procedures are critical and present associated hazards requiring attention to detail regarding quality control, weather conditions, static electricity, bonding, and spill/fires potential.

Any activity associated with rotors turning (i.e.; refueling embarking/disembarking, loading/unloading baggage/freight; etc.) personnel should only approach the aircraft when authorized to do so. Approach should be made via safe approach path/walkway or “arc” – **remain clear of all rotors.**

NOTE–

1. *Marine vessels, barges etc.: Vessel motion presents additional potential hazards to helicopter operations (blade flex, aircraft movement).*

2. *See National Fire Protection Association (NFPA) Document 407, “Standard for Aircraft Fuel Servicing” for specifics regarding non-HRR (routine refueling operations).*

10–2–2. Helicopter Night VFR Operations

a. Effect of Lighting on Seeing Conditions in Night VFR Helicopter Operations

NOTE–

This guidance was developed to support safe night VFR helicopter emergency medical services (HEMS) operations. The principles of lighting and seeing conditions are useful in any night VFR operation.

While ceiling and visibility significantly affect safety in night VFR operations, lighting conditions also have a profound effect on safety. Even in conditions in which visibility and ceiling are determined to be visual meteorological conditions, the ability to discern unlighted or low contrast objects and terrain at night may be compromised. The ability to discern these objects and terrain is the seeing condition, and is related to the amount of natural and man made lighting available, and the contrast, reflectivity, and texture of surface terrain and obstruction features. In order to conduct operations safely, seeing conditions must be accounted for in the planning and execution of night VFR operations.

Night VFR seeing conditions can be described by identifying “high lighting conditions” and “low lighting conditions.”

1. High lighting conditions exist when one of two sets of conditions are present:

(a) The sky cover is less than broken (less than 5/8 cloud cover), the time is between the local Moon rise and Moon set, and the lunar disk is at least 50% illuminated; or

(b) The aircraft is operated over surface lighting which, at least, provides for the lighting of prominent obstacles, the identification of terrain features (shorelines, valleys, hills, mountains, slopes) and a horizontal reference by which the pilot may control the helicopter. For example, this surface lighting may be the result of:

(1) Extensive cultural lighting (man-made, such as a built-up area of a city),

(2) Significant reflected cultural lighting (such as the illumination caused by the reflection of a major metropolitan area's lighting reflecting off a cloud ceiling), or

(3) Limited cultural lighting combined with a high level of natural reflectivity of celestial illumination, such as that provided by a surface covered by snow or a desert surface.

2. Low lighting conditions are those that do not meet the high lighting conditions requirements.

3. Some areas may be considered a high lighting environment only in specific circumstances. For example, some surfaces, such as a forest with limited cultural lighting, normally have little reflectivity, requiring dependence on significant moonlight to achieve a high lighting condition. However, when that same forest is covered with snow, its reflectivity may support a high lighting condition based only on starlight. Similarly, a desolate area, with little cultural lighting, such as a desert, may have such inherent natural reflectivity that it may be considered a high lighting conditions area regardless of season, provided the cloud cover does not prevent starlight from being reflected from the surface. Other surfaces, such as areas of open water, may never have enough reflectivity or cultural lighting to ever be characterized as a high lighting area.

4. Through the accumulation of night flying experience in a particular area, the operator will develop the ability to determine, prior to departure, which areas can be considered supporting high or low lighting conditions. Without that operational experience, low lighting considerations should be applied by operators for both pre-flight planning and operations until high lighting conditions are observed or determined to be regularly available.

b. Astronomical Definitions and Background Information for Night Operations

1. Definitions

(a) **Horizon.** Wherever one is located on or near the Earth's surface, the Earth is perceived as essentially flat and, therefore, as a plane. If there are no visual obstructions, the apparent intersection of the sky with the Earth's (plane) surface is the horizon, which appears as a circle centered at the observer. For rise/set computations, the observer's eye is considered to be on the surface of the Earth, so that the

horizon is geometrically exactly 90 degrees from the local vertical direction.

(b) **Rise, Set.** During the course of a day the Earth rotates once on its axis causing the phenomena of rising and setting. All celestial bodies, the Sun, Moon, stars and planets, seem to appear in the sky at the horizon to the East of any particular place, then to cross the sky and again disappear at the horizon to the West. Because the Sun and Moon appear as circular disks and not as points of light, a definition of rise or set must be very specific, because not all of either body is seen to rise or set at once.

(c) **Sunrise and sunset** refer to the times when the upper edge of the disk of the Sun is on the horizon, considered unobstructed relative to the location of interest. Atmospheric conditions are assumed to be average, and the location is in a level region on the Earth's surface.

(d) **Moonrise and moonset** times are computed for exactly the same circumstances as for sunrise and sunset. However, moonrise and moonset may occur at any time during a 24 hour period and, consequently, it is often possible for the Moon to be seen during daylight, and to have moonless nights. It is also possible that a moonrise or moonset does not occur relative to a specific place on a given date.

(e) **Transit.** The transit time of a celestial body refers to the instant that its center crosses an imaginary line in the sky – the observer's meridian – running from north to south.

(f) **Twilight.** Before sunrise and again after sunset there are intervals of time, known as "twilight," during which there is natural light provided by the upper atmosphere, which does receive direct sunlight and reflects part of it toward the Earth's surface.

(g) **Civil twilight** is defined to begin in the morning, and to end in the evening when the center of the Sun is geometrically 6 degrees below the horizon. This is the limit at which twilight illumination is sufficient, under good weather conditions, for terrestrial objects to be clearly distinguished.

2. Title 14 of the Code of Federal Regulations applies these concepts and definitions in addressing the definition of night (Section 1.1), the requirement for aircraft lighting (Section 91.209) and pilot recency of night experience (Section 61.67).

c. Information on Moon Phases and Changes in the Percentage of the Moon Illuminated

From any location on the Earth, the Moon appears to be a circular disk which, at any specific time, is illuminated to some degree by direct sunlight. During each lunar orbit (a lunar month), we see the Moon's appearance change from not visibly illuminated through partially illuminated to fully illuminated,

then back through partially illuminated to not illuminated again. There are eight distinct, traditionally recognized stages, called phases. The phases designate both the degree to which the Moon is illuminated and the geometric appearance of the illuminated part. These phases of the Moon, in the sequence of their occurrence (starting from New Moon), are listed in FIG 10-2-3.

FIG 10-2-3
Phases of the Moon

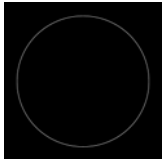

New Moon – The Moon's unilluminated side is facing the Earth. The Moon is not visible (except during a solar eclipse).

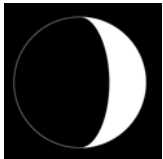

Waxing Crescent – The Moon appears to be partly but less than one-half illuminated by direct sunlight. The fraction of the Moon's disk that is illuminated is increasing.

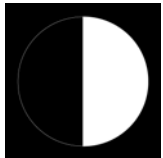

First Quarter – One-half of the Moon appears to be illuminated by direct sunlight. The fraction of the Moon's disk that is illuminated is increasing.

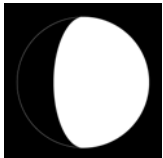

Waxing Gibbous – The Moon appears to be more than one-half but not fully illuminated by direct sunlight. The fraction of the Moon's disk that is illuminated is increasing.



Full Moon – The Moon's illuminated side is facing the Earth. The Moon appears to be completely illuminated by direct sunlight.

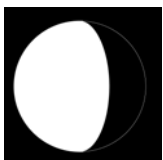

Waning Gibbous – The Moon appears to be more than one-half but not fully illuminated by direct sunlight. The fraction of the Moon's disk that is illuminated is decreasing.

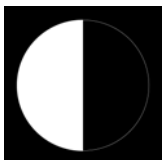

Last Quarter – One-half of the Moon appears to be illuminated by direct sunlight. The fraction of the Moon's disk that is illuminated is decreasing.



Waning Crescent – The Moon appears to be partly but less than one-half illuminated by direct sunlight. The fraction of the Moon's disk that is illuminated is decreasing.

1. The percent of the Moon’s surface illuminated is a more refined, quantitative description of the Moon’s appearance than is the phase. Considering the Moon as a circular disk, at New Moon the percent illuminated is 0; at First and Last Quarters it is 50%; and at Full Moon it is 100%. During the crescent phases the percent illuminated is between 0 and 50% and during gibbous phases it is between 50% and 100%.

2. For practical purposes, phases of the Moon and the percent of the Moon illuminated are independent of the location on the Earth from where the Moon is observed. That is, all the phases occur at the same time regardless of the observer’s position.

3. For more detailed information, refer to the United States Naval Observatory site referenced below.

d. Access to Astronomical Data for Determination of Moon Rise, Moon Set, and Percentage of Lunar Disk Illuminated

1. Astronomical data for the determination of Moon rise and set and Moon phase may be obtained from the United States Naval Observatory using an interactive query available at: <http://aa.usno.navy.mil/>

2. Click on “Data Services,” and then on “Complete Sun and Moon Data for One Day.”

3. You can obtain the times of sunrise, sunset, moonrise, moonset, transits of the Sun and Moon, and the beginning and end of civil twilight, along with information on the Moon’s phase by specifying the date and location in one of the two forms on this web page and clicking on the “Get data” button at the end of the form. Form “A” is used for cities or towns in the U.S. or its territories. Form “B” for all other locations. An example of the data available from this site is shown in TBL 10–2–2.

4. Additionally, a yearly table may be constructed for a particular location by using the “Table of Sunrise/Sunset, Moonrise/Moonset, or Twilight Times for an Entire Year” selection.

TBL 10–2–2
Sample of Astronomical Data Available from the Naval Observatory

The following information is provided for New Orleans, Orleans Parish, Louisiana (longitude W90.1, latitude N30.0)	
Tuesday 29 May 2007	Central Daylight Time
SUN	
Begin civil twilight	5:34 a.m.
Sunrise	6:01 a.m.
Sun transit	12:58 p.m.
Sunset	7:55 p.m.
End civil twilight	8:22 p.m.
MOON	
Moonrise	5:10 p.m. on preceding day
Moonset	4:07 a.m.
Moonrise	6:06 p.m.
Moon transit	11:26 p.m.
Moonset	4:41 a.m. on following day
Phase of the Moon on 29 May: waxing gibbous with 95% of the Moon’s visible disk illuminated.	
Full Moon on 31 May 2007 at 8:04 p.m. Central Daylight Time.	

10–2–3. Landing Zone Safety

a. This information is provided for use by helicopter emergency medical services (HEMS) pilots, program managers, medical personnel, law enforcement, fire, and rescue personnel to further their understanding of the safety issues concerning Landing Zones (LZs). It is recommended that HEMS operators establish working relationships with the ground responder organizations they may come in contact with in their flight operations and share this information in order to establish a common frame of reference for LZ selection, operations, and safety.

b. The information provided is largely based on the booklet, LZ – Preparing the Landing Zone, issued by National Emergency Medical Services Pilots Association (NEMSPA), and the guidance developed by the University of Tennessee Medical Center’s LIFESTAR program, and is used with their permission. For additional information, go to <http://www.nemspa.org/>.

c. Information concerning the estimation of wind velocity is based on the Beaufort Scale. See <http://www.spc.noaa.gov/faq/tornado/beaufort.html> for more information.

d. Selecting a Scene LZ

1. If the situation requires the use of a helicopter, first check to see if there is an area large enough to land a helicopter safely.

FIG 10-2-4

Recommended Minimum Landing Zone Dimensions

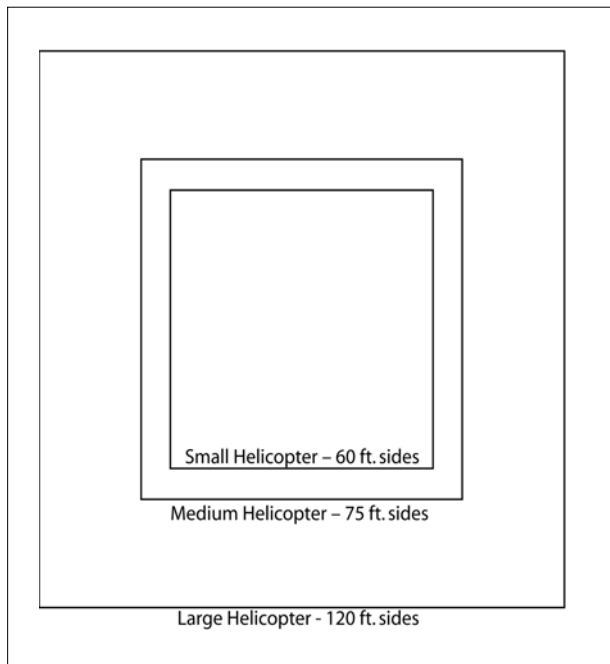

2. For the purposes of FIG 10-2-4 the following are provided as examples of relative helicopter size:

(a) Small Helicopter: Bell 206/407, Eurocopter AS-350/355, BO-105, BK-117.

(b) Medium Helicopter: Bell UH-1 (Huey) and derivatives (Bell 212/412), Bell 222/230/430 Sikorsky S-76, Eurocopter SA-365.

(c) Large Helicopter: Boeing Chinook, Eurocopter Puma, Sikorsky H-60 series (Blackhawk), SK-92.

3. The LZ should be level, firm and free of loose debris that could possibly blow up into the rotor system.

4. The LZ should be clear of people, vehicles and obstructions such as trees, poles and wires. Remember that wires are difficult to see from the air. The LZ must also be free of stumps, brush, post and large rocks. See FIG 10-2-5.

FIG 10-2-5

Landing Zone Hazards



5. Keep spectators back at least 200 feet. Keep emergency vehicles 100 feet away and have fire equipment (if available) standing by. Ground personnel should wear eye protection, if available, during landing and takeoff operations. To avoid loose objects being blown around in the LZ, hats should be removed; if helmets are worn, chin straps must be securely fastened.

6. Fire fighters (if available) should wet down the LZ if it is extremely dusty.

e. Helping the Flightcrew Locate the Scene

1. If the LZ coordinator has access to a GPS unit, the exact latitude and longitude of the LZ should be relayed to the HEMS pilot. If unable to contact the pilot directly, relay the information to the HEMS ground communications specialist for relaying to the pilot, so that they may locate your scene more efficiently. Recognize that the aircraft may approach from a direction different than the direct path from the takeoff point to the scene, as the pilot may have to detour around terrain, obstructions or weather en route.

2. Especially in daylight hours, mountainous and densely populated areas can make sighting a scene from the air difficult. Often, the LZ coordinator on the ground will be asked if she or he can see or hear the helicopter.

3. Flightcrews use a clock reference method for directing one another's attention to a certain direction from the aircraft. The nose of the aircraft is always 12 o'clock, the right side is 3 o'clock, etc. When the LZ coordinator sees the aircraft, he/she should use this method to assist the flightcrew by indicating the scene's clock reference position from the nose of the aircraft. For example, "Accident scene is located at your 2 o'clock position." See FIG 10-2-6.

FIG 10-2-6
"Clock" System for Identifying Positions
Relative to the Nose of the Aircraft

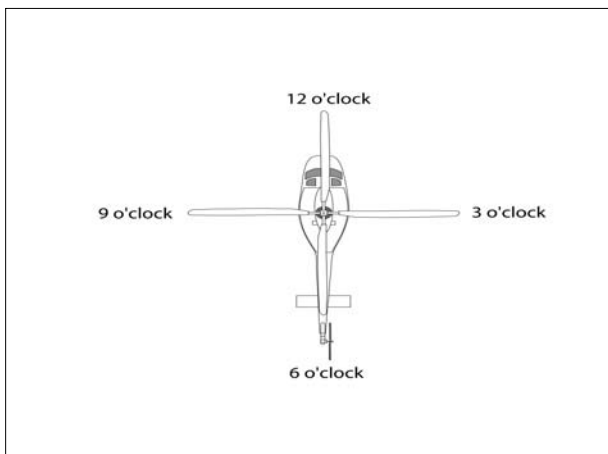

4. When the helicopter approaches the scene, it will normally orbit at least one time as the flight crew observes the wind direction and obstacles that could interfere with the landing. This is often referred to as the "high reconnaissance" maneuver.

f. Wind Direction and Touchdown Area

1. Determine from which direction the wind is blowing. Helicopters normally land and takeoff into the wind.

2. If contact can be established with the pilot, either directly or indirectly through the HEMS ground communications specialist, describe the wind in terms of the direction the wind is *from* and the speed.

3. Common natural sources of wind direction information are smoke, dust, vegetation movement, water streaks and waves. Flags, pennants, streamers can also be used. When describing the direction, use the compass direction from which the wind is blowing (example: from the North-West).

4. Wind speed can be measured by small hand-held measurement devices, or an observer's estimate can be used to provide velocity information. The wind value should be reported in knots (nautical miles per hour). If unable to numerically measure wind speed, use TBL 10-2-3 to estimate velocity. Also, report if the wind conditions are gusty, or if the wind direction or velocity is variable or has changed recently.

5. If any obstacle(s) exist, ensure their description, position and approximate height are communicated to the pilot on the initial radio call.

TBL 10-2-3

Table of Common References for Estimating Wind Velocity

Wind (Knots)	Wind Classification	Appearance of Wind Effects	
		On the Water	On Land
Less than 1	Calm	Sea surface smooth and mirror-like	Calm, smoke rises vertically
1-3	Light Air	Scaly ripples, no foam crests	Smoke drift indicates wind direction, wind vanes are still
4-6	Light Breeze	Small wavelets, crests glassy, no breaking	Wind felt on face, leaves rustle, vanes begin to move
7-10	Gentle Breeze	Large wavelets, crests begin to break, scattered whitecaps	Leaves and small twigs constantly moving, light flags extended
11-16	Moderate Breeze	Small waves 1-4 ft. becoming longer, numerous whitecaps	Dust, leaves, and loose paper lifted, small tree branches move
17-21	Fresh Breeze	Moderate waves 4-8 ft. taking longer form, many whitecaps, some spray	Small trees in leaf begin to sway
22-27	Strong Breeze	Larger waves 8-13 ft., whitecaps common, more spray	Larger tree branches moving, whistling in wires
28-33	Near Gale	Sea heaps up, waves 13-20 ft., white foam streaks off breakers	Whole trees moving, resistance felt walking against wind
34-40	Gale	Moderately high (13-20 ft.) waves of greater length, edges of crests begin to break into spindrift, foam blown in streaks	Whole trees in motion, resistance felt walking against wind
41-47	Strong Gale	High waves (20 ft.), sea begins to roll, dense streaks of foam, spray may reduce visibility	Slight structural damage occurs, slate blows off roofs
48-55	Storm	Very high waves (20-30 ft.) with overhanging crests, sea white with densely blown foam, heavy rolling, lowered visibility	Seldom experienced on land, trees broken or uprooted, "considerable structural damage"
56-63	Violent Storm	Exceptionally high (30-45 ft.) waves, foam patches cover sea, visibility more reduced	
64+	Hurricane	Air filled with foam, waves over 45 ft., sea completely white with driving spray, visibility greatly reduced	

EXAMPLE-

Wind from the South-East, estimated speed 15 knots. Wind shifted from North-East about fifteen minutes ago, and is gusty.

g. Night LZs

1. There are several ways to light a night LZ:

(a) Mark the touchdown area with five lights or road flares, one in each corner and one indicating the direction of the wind. See FIG 10-2-7.

FIG 10-2-7
Recommended Lighting for
Landing Zone Operations at Night

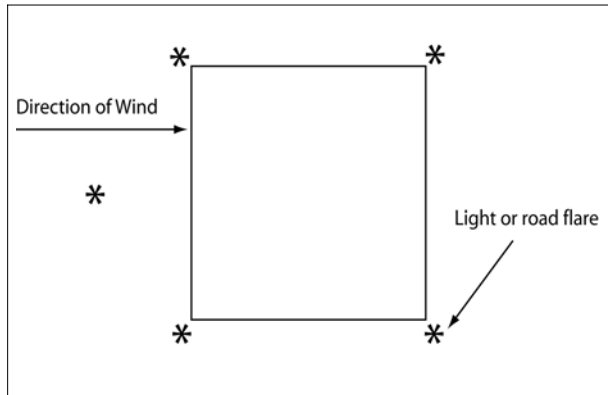

NOTE-

Road flares are an intense source of ignition and may be unsuitable or dangerous in certain conditions. In any case, they must be closely managed and firefighting equipment should be present when used. Other light sources are preferred, if available.

(b) If chemical light sticks may be used, care should be taken to assure they are adequately secured against being dislodged by the helicopter's rotor wash.

(c) Another method of marking a LZ uses four emergency vehicles with their low beam headlights aimed toward the intended landing area.

(d) A third method for marking a LZ uses two vehicles. Have the vehicles direct their headlight beams into the wind, crossing at the center of the LZ. (If fire/rescue personnel are available, the reflective stripes on their bunker gear will assist the pilot greatly.)

2. At night, spotlights, flood lights and hand lights used to define the LZ are not to be pointed at the helicopter. However, they are helpful when pointed toward utility poles, trees or other hazards to the landing aircraft. White lights such as spotlights, flashbulbs and hi-beam headlights ruin the pilot's night vision and temporarily blind him. Red lights, however, are very helpful in finding accident

locations and do not affect the pilot's night vision as significantly.

3. As in Day LZ operations, ensure radio contact is accomplished between ground and air, if possible.

h. Ground Guide

1. When the helicopter is in sight, one person should assist the LZ Coordinator by guiding the helicopter into a safe landing area. In selecting an LZ Coordinator, recognize that medical personnel usually are very busy with the patient at this time. It is recommended that the LZ Coordinator be someone other than a medical responder, if possible. Eye protection should be worn. The ground guide should stand with his/her back to the wind and his/her arms raised over his/her head (flashlights in each hand for night operations.)

2. The pilot will confirm the LZ sighting by radio. If possible, once the pilot has identified the LZ, the ground guide should move out of the LZ.

3. As the helicopter turns into the wind and begins a descent, the LZ coordinator should provide assistance by means of radio contact, or utilize the "unsafe signal" to wave off the helicopter if the LZ is not safe (see FIG 10-2-8). The LZ Coordinator should be far enough from the touchdown area that he/she can still maintain visual contact with the pilot.

i. Assisting the Crew

1. After the helicopter has landed, do not approach the helicopter. The crew will approach you.

2. Be prepared to assist the crew by providing security for the helicopter. If asked to provide security, allow no one but the crew to approach the aircraft.

3. Once the patient is prepared and ready to load, allow the crew to open the doors to the helicopter and guide the loading of the patient.

4. When approaching or departing the helicopter, always be aware of the tail rotor and always follow the directions of the crew. Working around a running helicopter can be potentially dangerous. The environment is very noisy and, with exhaust gases and rotor wash, often windy. In scene operations, the surface may be uneven, soft, or slippery which can lead to tripping. Be very careful of your footing in this environment.

5. The tail rotor poses a special threat to working around a running helicopter. The tail rotor turns many times faster than the main rotor, and is often invisible even at idle engine power. Avoid walking towards the tail of a helicopter beyond the end of the cabin, unless specifically directed by the crew.

NOTE–

Helicopters typically have doors on the sides of the cabin, but many use aft mounted “clamshell” type doors for loading and unloading patients on litters or stretchers. When using these doors, it is important to avoid moving any further aft than necessary to operate the doors and load/unload the patient. Again, always comply with the crew’s instructions.

j. General Rules

1. When working around helicopters, always approach and depart from the front, never from the rear. Approaching from the rear can increase your risk of being struck by the tail rotor, which, when at operating engine speed, is nearly invisible.

2. To prevent injury or damage from the main rotor, never raise anything over your head.

3. If the helicopter landed on a slope, approach and depart from the down slope side only.

4. When the helicopter is loaded and ready for take off, keep the departure path free of vehicles and spectators. In an emergency, this area is needed to execute a landing.

k. Hazardous Chemicals and Gases

1. Responding to accidents involving hazardous materials requires special handling by fire/rescue units on the ground. Equally important are the preparations and considerations for helicopter operations in these areas.

2. Hazardous materials of concern are those which are toxic, poisonous, flammable, explosive, irritating, or radioactive in nature. Helicopter ambulance crews normally don’t carry protective suits or breathing apparatuses to protect them from hazardous materials.

3. The helicopter ambulance crew must be told of hazardous materials on the scene in order to avoid

the contamination of the crew. Patients/victims contaminated by hazardous materials may require special precautions in packaging before loading on the aircraft for the medical crew’s protection, or may be transported by other means.

4. Hazardous chemicals and gases may be fatal to the unprotected person if inhaled or absorbed through the skin.

5. Upon initial radio contact, the helicopter crew must be made aware of any hazardous gases in the area. Never assume that the crew has already been informed. If the aircraft were to fly through the hazardous gases, the crew could be poisoned and/or the engines could develop mechanical problems.

6. Poisonous or irritating gases may cling to a victim’s clothing and go unnoticed until the patient is loaded and the doors of the helicopter are closed. To avoid possible compromise of the crew, all of these patients must be decontaminated prior to loading.

l. Hand Signals

1. If unable to make radio contact with the HEMS pilot, use the following signals:

FIG 10–2–8

Recommended Landing Zone Ground Signals

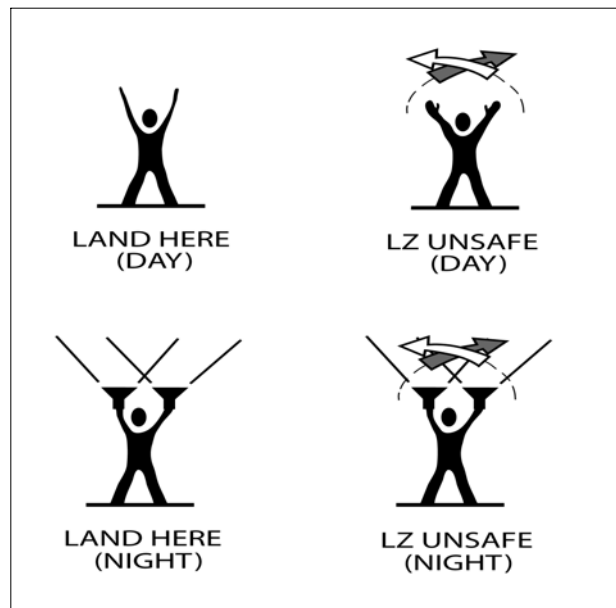

m. Emergency Situations

1. In the event of a helicopter accident in the vicinity of the LZ, consider the following:

(a) Emergency Exits:

(1) Doors and emergency exits are typically prominently marked. If possible, operators should familiarize ground responders with the door system on their helicopter in preparation for an emergency event.

(2) In the event of an accident during the LZ operation, be cautious of hazards such as sharp and jagged metal, plastic windows, glass, any rotating components, such as the rotors, and fire sources, such as the fuel tank(s) and the engine.

(b) Fire Suppression:

Helicopters used in HEMS operations are usually powered by turboshaft engines, which use jet fuel. Civil HEMS aircraft typically carry between 50 and 250 gallons of fuel, depending upon the size of the helicopter, and planned flight duration, and the fuel remaining after flying to the scene. Use water to control heat and use foam over fuel to keep vapors from ignition sources.

10-2-4. Emergency Medical Service (EMS) Multiple Helicopter Operations

a. Background. EMS helicopter operators often overlap other EMS operator areas. Standardized procedures can enhance the safety of operating multiple helicopters to landing zones (LZs) and to hospital heliports. Communication is the key to successful operations and in maintaining organization between helicopters, ground units and communication centers. EMS helicopter operators which operate in the same areas should establish joint operating procedures and provide them to related agencies.

b. Recommended Procedures.

1. Landing Zone Operations. The first helicopter to arrive on-scene should establish communications with the ground unit at least 10 NMs from the LZ to receive a LZ briefing and to provide ground control the number of helicopters that can be expected. An attempt should be made to contact other helicopters on 123.025 to pass on to them pertinent LZ information and the ground unit's frequency. Subsequent helicopters arriving on scene should

establish communications on 123.025 at least 10 NMs from the LZ. After establishing contact on 123.025, they should contact the ground unit for additional information. All helicopters should monitor 123.025 at all times.

(a) If the landing zone is not established by the ground unit when the first helicopter arrives, then the first helicopter should establish altitude and orbit location requirements for the other arriving helicopters. Recommended altitude separation between helicopters is 500 feet (weather and airspace permitting). Helicopters can orbit on cardinal headings from the scene coordinates. (See FIG 10-2-9.)

(b) Upon landing in the LZ, the first helicopter should update the other helicopters on the LZ conditions, i.e., space, hazards and terrain.

(c) Before initiating any helicopter movement to leave the LZ, all operators should attempt to contact other helicopters on 123.025, and state their position and route of flight intentions for departing the LZ.

2. Hospital Operations. Because many hospitals require landing permission and have established procedures (frequencies to monitor, primary and secondary routes for approaches and departures, and orbiting areas if the heliport is occupied) pilots should always receive a briefing from the appropriate facility (communication center, flight following, etc.) before proceeding to the hospital.

(a) In the event of multiple helicopters coming into the hospital heliport, the helicopter nearest to the heliport should contact other inbound helicopters on 123.025 and establish intentions. Follow the guidelines established in the LZ operations.

(b) To facilitate approach times, the pilot-in-command of the helicopter occupying the hospital heliport should advise any other operators whether the patient will be off loaded with the rotor blades turning or stopped, and the approximate time to do so.

(c) Before making any helicopter movement to leave the hospital heliport, all operators should attempt to contact other helicopters on 123.025 and state their position and route of flight intentions for departing the heliport.

FIG 10-2-9
EMS Multiple Helicopter LZ/Heliport Operation

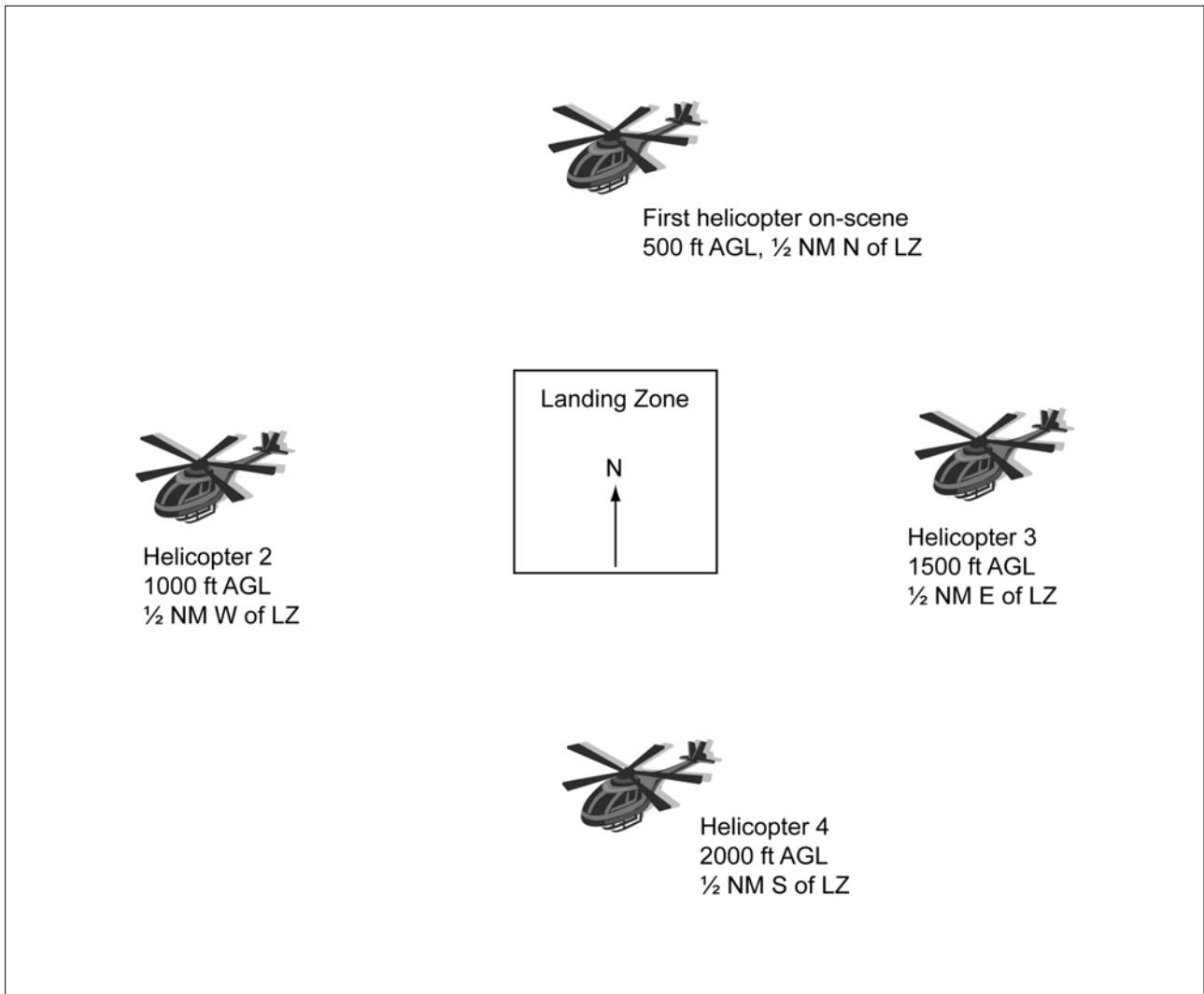

NOTE-

If the LZ/hospital heliport weather conditions or airspace altitude restrictions prohibit the recommended vertical separation, 1 NM separations should be kept between helicopter orbit areas.

Appendix 1. Bird/Other Wildlife Strike Report

Form Approved OMB NO. 2120-0018

BIRD/OTHER WILDLIFE STRIKE REPORT																																																			
1. Name of Operator		2. Aircraft Make/Model		3. Engine Make/Model																																															
4. Aircraft Registration		5. Date of Incident ____/____/____ Month Day Year		6. Local Time of Incident <input type="checkbox"/> Dawn <input type="checkbox"/> Dusk — HR — MIN <input type="checkbox"/> Day <input type="checkbox"/> Night <input type="checkbox"/> AM <input type="checkbox"/> PM																																															
7. Airport Name		8. Runway Used		9. Location If En Route (Nearest Town/Reference & State)																																															
10. Height (AGL)		11. Speed (IAS)																																																	
12. Phase of Flight <input type="checkbox"/> A. Parked <input type="checkbox"/> B. Taxi <input type="checkbox"/> C. Take-off Run <input type="checkbox"/> D. Climb <input type="checkbox"/> E. En Route <input type="checkbox"/> F. Descent <input type="checkbox"/> G. Approach <input type="checkbox"/> H. Landing Roll		13. Part(s) of Aircraft Struck or Damaged																																																	
		<table border="1" style="width: 100%; border-collapse: collapse;"> <thead> <tr> <th></th> <th style="text-align: center;">Struck</th> <th style="text-align: center;">Damaged</th> </tr> </thead> <tbody> <tr><td>A. Radome</td><td style="text-align: center;"><input type="checkbox"/></td><td style="text-align: center;"><input type="checkbox"/></td></tr> <tr><td>B. Windshield</td><td style="text-align: center;"><input type="checkbox"/></td><td style="text-align: center;"><input type="checkbox"/></td></tr> <tr><td>C. Nose</td><td style="text-align: center;"><input type="checkbox"/></td><td style="text-align: center;"><input type="checkbox"/></td></tr> <tr><td>D. Engine No. 1</td><td style="text-align: center;"><input type="checkbox"/></td><td style="text-align: center;"><input type="checkbox"/></td></tr> <tr><td>E. Engine No. 2</td><td style="text-align: center;"><input type="checkbox"/></td><td style="text-align: center;"><input type="checkbox"/></td></tr> <tr><td>F. Engine No. 3</td><td style="text-align: center;"><input type="checkbox"/></td><td style="text-align: center;"><input type="checkbox"/></td></tr> <tr><td>G. Engine No. 4</td><td style="text-align: center;"><input type="checkbox"/></td><td style="text-align: center;"><input type="checkbox"/></td></tr> </tbody> </table>			Struck	Damaged	A. Radome	<input type="checkbox"/>	<input type="checkbox"/>	B. Windshield	<input type="checkbox"/>	<input type="checkbox"/>	C. Nose	<input type="checkbox"/>	<input type="checkbox"/>	D. Engine No. 1	<input type="checkbox"/>	<input type="checkbox"/>	E. Engine No. 2	<input type="checkbox"/>	<input type="checkbox"/>	F. Engine No. 3	<input type="checkbox"/>	<input type="checkbox"/>	G. Engine No. 4	<input type="checkbox"/>	<input type="checkbox"/>	<table border="1" style="width: 100%; border-collapse: collapse;"> <thead> <tr> <th></th> <th style="text-align: center;">Struck</th> <th style="text-align: center;">Damaged</th> </tr> </thead> <tbody> <tr><td>H. Propeller</td><td style="text-align: center;"><input type="checkbox"/></td><td style="text-align: center;"><input type="checkbox"/></td></tr> <tr><td>I. Wing/Rotor</td><td style="text-align: center;"><input type="checkbox"/></td><td style="text-align: center;"><input type="checkbox"/></td></tr> <tr><td>J. Fuselage</td><td style="text-align: center;"><input type="checkbox"/></td><td style="text-align: center;"><input type="checkbox"/></td></tr> <tr><td>K. Landing Gear</td><td style="text-align: center;"><input type="checkbox"/></td><td style="text-align: center;"><input type="checkbox"/></td></tr> <tr><td>L. Tail</td><td style="text-align: center;"><input type="checkbox"/></td><td style="text-align: center;"><input type="checkbox"/></td></tr> <tr><td>M. Lights</td><td style="text-align: center;"><input type="checkbox"/></td><td style="text-align: center;"><input type="checkbox"/></td></tr> <tr><td>N. Other:</td><td style="text-align: center;"><input type="checkbox"/></td><td style="text-align: center;"><input type="checkbox"/></td></tr> </tbody> </table>			Struck	Damaged	H. Propeller	<input type="checkbox"/>	<input type="checkbox"/>	I. Wing/Rotor	<input type="checkbox"/>	<input type="checkbox"/>	J. Fuselage	<input type="checkbox"/>	<input type="checkbox"/>	K. Landing Gear	<input type="checkbox"/>	<input type="checkbox"/>	L. Tail	<input type="checkbox"/>	<input type="checkbox"/>	M. Lights	<input type="checkbox"/>	<input type="checkbox"/>	N. Other:
	Struck	Damaged																																																	
A. Radome	<input type="checkbox"/>	<input type="checkbox"/>																																																	
B. Windshield	<input type="checkbox"/>	<input type="checkbox"/>																																																	
C. Nose	<input type="checkbox"/>	<input type="checkbox"/>																																																	
D. Engine No. 1	<input type="checkbox"/>	<input type="checkbox"/>																																																	
E. Engine No. 2	<input type="checkbox"/>	<input type="checkbox"/>																																																	
F. Engine No. 3	<input type="checkbox"/>	<input type="checkbox"/>																																																	
G. Engine No. 4	<input type="checkbox"/>	<input type="checkbox"/>																																																	
	Struck	Damaged																																																	
H. Propeller	<input type="checkbox"/>	<input type="checkbox"/>																																																	
I. Wing/Rotor	<input type="checkbox"/>	<input type="checkbox"/>																																																	
J. Fuselage	<input type="checkbox"/>	<input type="checkbox"/>																																																	
K. Landing Gear	<input type="checkbox"/>	<input type="checkbox"/>																																																	
L. Tail	<input type="checkbox"/>	<input type="checkbox"/>																																																	
M. Lights	<input type="checkbox"/>	<input type="checkbox"/>																																																	
N. Other:	<input type="checkbox"/>	<input type="checkbox"/>																																																	
<i>(Specify, if "N. Other" is checked)</i>																																																			
14. Effect on Flight <input type="checkbox"/> None <input type="checkbox"/> Aborted Take-Off <input type="checkbox"/> Precautionary Landing <input type="checkbox"/> Engines Shut Down <input type="checkbox"/> Other: <i>(Specify)</i>		15. Sky Condition <input type="checkbox"/> No Cloud <input type="checkbox"/> Some Cloud <input type="checkbox"/> Overcast		16. Precipitation <input type="checkbox"/> Fog <input type="checkbox"/> Rain <input type="checkbox"/> Snow <input type="checkbox"/> None																																															
17. Bird/Other Wildlife Species		18. Number or birds seen and/or struck			19. Size of Bird(s) <input type="checkbox"/> Small <input type="checkbox"/> Medium <input type="checkbox"/> Large																																														
		Number of Birds	Seen	Struck																																															
		1	<input type="checkbox"/>	<input type="checkbox"/>																																															
		2-10	<input type="checkbox"/>	<input type="checkbox"/>																																															
		11-100	<input type="checkbox"/>	<input type="checkbox"/>																																															
		more than 100	<input type="checkbox"/>	<input type="checkbox"/>																																															
20. Pilot Warned of Birds <input type="checkbox"/> Yes <input type="checkbox"/> No																																																			
21. Remarks <i>(Describe damage, injuries and other pertinent information)</i>																																																			
DAMAGE / COST INFORMATION																																																			
22. Aircraft time out of service: _____ hours		23. Estimated cost of repairs or replacement (U.S. \$): \$ _____		24. Estimated other cost (U.S. \$) (e.g. loss of revenue, fuel, hotels): \$ _____																																															
Reported by <i>(Optional)</i>			Title	Date																																															
<p>Paperwork Reduction Act Statement: The information collected on this form is necessary to allow the Federal Aviation Administration to assess the magnitude and severity of the wildlife-aircraft strike problem in the U.S. The information is used in determining the best management practices for reducing the hazard to aviation safety caused by wildlife-aircraft strikes. We estimate that it will take approximately <u>5 minutes</u> to complete the form. If you wish to make any comments concerning the accuracy of this burden estimate and any suggestions for reducing this burden, send those comments to the Federal Aviation Administration, Management Staff, ARP-10, 800 Independence Avenue, SW, Washington, DC 20591. The information collected is voluntary. Please note that an agency may not conduct or sponsor, and a person is not required to respond to, a collection of information unless it displays a currently valid OMB control number. The OMB control number associated with this collection is 2120-0045.</p>																																																			

U.S. Department
of Transportation
**Federal Aviation
Administration**
800 Independence Ave., S.W.
Washington, D C 20591

Official Business
Penalty for Private Use, \$300



NO POSTAGE
NECESSARY
IF MAILED IN
THE UNITED
STATES

BUSINESS REPLY MAIL
FIRST CLASS PERMIT NO. 12438 WASHINGTON D.C.



POSTAGE WILL BE PAID BY THE FEDERAL AVIATION ADMINISTRATION

Federal Aviation Administration
Office of Airport Safety and Standards, AAS-310
800 Independence Avenue, SW
WASHINGTON, DC 20591

FOLD AND TAPE HERE

Appendix 2. Volcanic Activity Reporting Form (VAR)

Date _____

SECTION 1 - Transmit to ATC via radio	1. Aircraft Identification			
	2. Position			
	3. Time (UTC)			
	4. Flight level or altitude			
	5. Position/location of volcanic activity or ash cloud			
	6. Air temperature			
	7. Wind			
	8. Supplementary Information <small>(Brief description of activity including vertical and lateral extent of the ash cloud, horizontal movement, rate of growth, etc., as available.)</small>			
Mark the appropriate box(s)				
SECTION 2 - Complete and forward as directed	9. <i>Density of ash cloud</i>	<input type="checkbox"/> wispy	<input type="checkbox"/> moderately dense	<input type="checkbox"/> very dense
	10. <i>Color of ash</i>	<input type="checkbox"/> white <input type="checkbox"/> black	<input type="checkbox"/> light gray	<input type="checkbox"/> dark gray
	11. <i>Eruption</i>	<input type="checkbox"/> continuous	<input type="checkbox"/> intermittent	<input type="checkbox"/> not visible
	12. <i>Position of activity</i>	<input type="checkbox"/> summit <input type="checkbox"/> multiple	<input type="checkbox"/> side <input type="checkbox"/> not observed	<input type="checkbox"/> single
	13. <i>Other observed features of eruption</i>	<input type="checkbox"/> lightning <input type="checkbox"/> ash fallout	<input type="checkbox"/> glow <input type="checkbox"/> mushroom cloud	<input type="checkbox"/> large rocks <input type="checkbox"/> none
	14. <i>Effect on aircraft</i>	<input type="checkbox"/> communications <input type="checkbox"/> pitot static <input type="checkbox"/> none	<input type="checkbox"/> navigation system <input type="checkbox"/> windscreen	<input type="checkbox"/> engines <input type="checkbox"/> other windows
	15. <i>Other effects</i>	<input type="checkbox"/> turbulence <input type="checkbox"/> ash deposits	<input type="checkbox"/> St. Elmo's fire	<input type="checkbox"/> fumes
16. <i>Other information deemed useful</i>				

Forward completed form via mail to:
 Global Volcanism Program
 NHB-119
 Smithsonian Institution
 Washington, DC 20560
 E-mail address: GVN@volcano.si.edu

Or Fax to:
 Global Volcanism Program
 (202) 357-2476

Appendix 3. Abbreviations/Acronyms

As used in this manual, the following abbreviations/acronyms have the meanings indicated.

Abbreviation/ Acronym	Meaning
AAWU	Alaskan Aviation Weather Unit
AAS	Airport Advisory Service
AC	Advisory Circular
ACAR	Aircraft Communications Addressing and Reporting System
ADCUS	Advise Customs
ADDS	Aviation Digital Data Service
ADF	Automatic Direction Finder
ADIZ	Air Defense Identification Zone
ADS-B	Automatic Dependent Surveillance–Broadcast
AFB	Air Force Base
AFCS	Automatic Flight Control System
AFIS	Automatic Flight Information Service
AFM	Aircraft Flight Manual
AGL	Above Ground Level
AHRS	Attitude Heading Reference System
AIM	Aeronautical Information Manual
AIRMET	Airmen’s Meteorological Information
AIS	Aeronautical Information Services
ALD	Available Landing Distance
ALDARS	Automated Lightning Detection and Reporting System
ALS	Approach Light Systems
AMSL	Above Mean Sea Level
ANP	Actual Navigation Performance
AOCC	Airline Operations Control Center
AP	Autopilot System
APV	Approach with Vertical Guidance
AR	Authorization Required
ARENA	Areas Noted for Attention
ARFF IC	Aircraft Rescue and Fire Fighting Incident Commander
ARINC	Aeronautical Radio Incorporated
ARO	Airport Reservations Office
ARSA	Airport Radar Service Area
ARSR	Air Route Surveillance Radar
ARTCC	Air Route Traffic Control Center
ARTS	Automated Radar Terminal System
ASDE-X	Airport Surface Detection Equipment – Model X
ASOS	Automated Surface Observing System
ASR	Airport Surveillance Radar

Abbreviation/ Acronym	Meaning
ASRS	Aviation Safety Reporting System
ASSC	Airport Surface Surveillance Capability
ATC	Air Traffic Control
ATCRBS	Air Traffic Control Radar Beacon System
ATCSCC	Air Traffic Control System Command Center
ATCT	Airport Traffic Control Tower
ATD	Along–Track Distance
ATIS	Automatic Terminal Information Service
ATT	Attitude Retention System
AWC	Aviation Weather Center
AWOS	Automated Weather Observing System
AWTT	Aviation Weather Technology Transfer
AWW	Severe Weather Forecast Alert
BAASS	Bigelow Aerospace Advanced Space Studies
BBS	Bulletin Board System
BC	Back Course
BECMG	Becoming group
C/A	Coarse Acquisition
CARTS	Common Automated Radar Terminal System (ARTS) (to include ARTS IIIIE and ARTS IIE)
CAT	Clear Air Turbulence
CD	Controller Display
CDI	Course Deviation Indicator
CDR	Coded Departure Route
CERAP	Combined Center/RAPCON
CFA	Controlled Firing Area
CFIT	Controlled Flight into Terrain
CFR	Code of Federal Regulations
COA	Certificate of Waiver or Authorization
CPDLC	Controller Pilot Data Link Communications
CTAF	Common Traffic Advisory Frequency
CVFP	Chartered Visual Flight Procedure
CVRS	Computerized Voice Reservation System
CWA	Center Weather Advisory
CWSU	Center Weather Service Unit
DA	Decision Altitude
DCA	Ronald Reagan Washington National Airport
DCP	Data Collection Package
DER	Departure End of Runway
DH	Decision Height

Abbreviation/ Acronym	Meaning
DME	Distance Measuring Equipment
DME/N	Standard DME
DME/P	Precision DME
DOD	Department of Defense
DP	Instrument Departure Procedure
DPU	Data Processor Unit
DRT	Diversion Recovery Tool
DRVSM	Domestic Reduced Vertical Separation Minimum
DVA	Diverse Vector Area
DVFR	Defense Visual Flight Rules
DVRSN	Diversion
EDCT	Expect Departure Clearance Time
EFAS	En Route Flight Advisory Service
EFV	Enhanced Flight Visibility
EFVS	Enhanced Flight Vision System
ELT	Emergency Locator Transmitter
EMAS	Engineered Materials Arresting System
EPE	Estimate of Position Error
ESV	Expanded Service Volume
ETA	Estimated Time of Arrival
ETD	Estimated Time of Departure
ETE	Estimated Time En Route
EWINS	Enhanced Weather Information System
EWR	Newark International Airport
FA	Area Forecast
FAA	Federal Aviation Administration
FAF	Final Approach Fix
FAROS	Final Approach Runway Occupancy Signal
FAWP	Final Approach Waypoint
FB	Fly-by
FCC	Federal Communications Commission
FD	Flight Director System
FDC	Flight Data Center
FDE	Fault Detection and Exclusion
FIR	Flight Information Region
FIS	Flight Information Service
FISDL	Flight Information Services Data Link
FLIP	Flight Information Publication
FMS	Flight Management System
FO	Fly-over
FPA	Flight Path Angle
FPV	Flight Path Vector
FPNM	Feet Per Nautical Mile
FSDO	Flight Standards District Office
FSS	Flight Service Station
GBAS	Ground Based Augmentation System

Abbreviation/ Acronym	Meaning
GEO	Geostationary Satellite
GLS	GBAS Landing System
GNSS	Global Navigation Satellite System
GNSSP	Global Navigation Satellite System Panel
GPS	Global Positioning System
GRI	Group Repetition Interval
GSD	Geographical Situation Display
GUS	Ground Uplink Station
HAT	Height Above Touchdown
HDTA	High Density Traffic Airports
HEMS	Helicopter Emergency Medical Services
HIRL	High Intensity Runway Lights
HIWAS	Hazardous Inflight Weather Advisory Service
HRR	Helicopter Rapid Refueling Procedures
HUD	Head-Up Display
Hz	Hertz
IAF	Initial Approach Fix
IAP	Instrument Approach Procedure
IAS	Indicated Air Speed
IAWP	Initial Approach Waypoint
ICAO	International Civil Aviation Organization
IF	Intermediate Fix
IFR	Instrument Flight Rules
ILS	Instrument Landing System
ILS/PRM	Instrument Landing System/Precision Runway Monitor
IM	Inner Marker
IMC	Instrument Meteorological Conditions
InFO	Information For Operators
INS	Inertial Navigation System
IOC	Initial Operational Capability
IR	IFR Military Training Route
IRU	Inertial Reference Unit
ITWS	Integrated Terminal Weather System
JFK	John F. Kennedy International Airport
kHz	Kilohertz
LAA	Local Airport Advisory
LAAS	Local Area Augmentation System
LAHSO	Land and Hold Short Operations
LAWRS	Limited Aviation Weather Reporting Station
LDA	Localizer Type Directional Aid
LDA/PRM	Localizer Type Directional Aid/Precision Runway Monitor
LGA	LaGuardia Airport
LIRL	Low Intensity Runway Lights
LLWAS	Low Level Wind Shear Alert System

Abbreviation/ Acronym	Meaning
LLWAS NE .	Low Level Wind Shear Alert System Network Expansion
LLWAS-RS .	Low Level Wind Shear Alert System Relocation/Sustainment
LNAV	Lateral Navigation
LOC	Localizer
LOP	Line-of-position
LORAN	Long Range Navigation System
LP	Localizer Performance
LPV	Localizer Performance with Vertical Guidance
LUAW	Line Up and Wait
LZ	Landing Zone
MAHWP	Missed Approach Holding Waypoint
MAP	Missed Approach Point
MAWP	Missed Approach Waypoint
MDA	Minimum Descent Altitude
MEA	Minimum En Route Altitude
MEARTS	Micro En Route Automated Radar Tracking System
METAR	Aviation Routine Weather Report
MHz	Megahertz
MIRL	Medium Intensity Runway Lights
MM	Middle Marker
MOA	Military Operations Area
MOCA	Minimum Obstruction Clearance Altitude
MRA	Minimum Reception Altitude
MRB	Magnetic Reference Bearing
MSA	Minimum Safe Altitude
MSAW	Minimum Safe Altitude Warning
MSL	Mean Sea Level
MTI	Moving Target Indicator
MTOS	Mountain Obscuration
MTR	Military Training Route
MVA	Minimum Vectoring Altitude
MWA	Mountain Wave Activity
MWO	Meteorological Watch Office
NAS	National Airspace System
NASA	National Aeronautics and Space Administration
NAVAID	Navigational Aid
NAVCEN	Coast Guard Navigation Center
NCWF	National Convective Weather Forecast
NDB	Nondirectional Radio Beacon
NEXRAD	Next Generation Weather Radar
NFDC	National Flight Data Center
NGA	National Geospatial-Intelligence Agency
NM	Nautical Mile

Abbreviation/ Acronym	Meaning
NMAC	Near Midair Collision
NOAA	National Oceanic and Atmospheric Administration
NOPAC	North Pacific
NoPT	No Procedure Turn Required
NOTAM	Notice to Airmen
NPA	Nonprecision Approach
NRS	Navigation Reference System
NSA	National Security Area
NSW	No Significant Weather
NTAP	Notices to Airmen Publication
NTSB	National Transportation Safety Board
NTZ	No Transgression Zone
NWS	National Weather Service
OAT	Outside Air Temperature
OBS	Omni-bearing Selector
ODP	Obstacle Departure Procedure
OIS	Operational Information System
OIS	Obstacle Identification Surface
OM	Outer Marker
ORD	Chicago O'Hare International Airport
PA	Precision Approach
PAPI	Precision Approach Path Indicator
PAR	Precision Approach Radar
PAR	Preferred Arrival Route
PC	Personal Computer
P/CG	Pilot/Controller Glossary
PDC	Pre-departure Clearance
PFD	Personal Flotation Device
PinS	Point-in-Space
PIREP	Pilot Weather Report
POB	Persons on Board
POFZ	Precision Obstacle Free Zone
POI	Principal Operations Inspector
PPS	Precise Positioning Service
PRM	Precision Runway Monitor
PT	Procedure Turn
QICP	Qualified Internet Communications Provider
RA	Resolution Advisory
RAA	Remote Advisory Airport
RAIM	Receiver Autonomous Integrity Monitoring
RAIS	Remote Airport Information Service
RBDT	Ribbon Display Terminals
RCAG	Remote Center Air/Ground
RCC	Rescue Coordination Center
RCLS	Runway Centerline Lighting System

Abbreviation/ Acronym	Meaning
RCO	Remote Communications Outlet
RD	Rotor Diameter
REIL	Runway End Identifier Lights
REL	Runway Entrance Lights
RFM	Rotorcraft Flight Manual
RIL	Runway Intersection Lights
RLIM	Runway Light Intensity Monitor
RMI	Radio Magnetic Indicator
RNAV	Area Navigation
RNP	Required Navigation Performance
ROC	Required Obstacle Clearance
RPAT	RNP Parallel Approach Runway Transitions
RVR	Runway Visual Range
RVSM	Reduced Vertical Separation Minimum
RWSL	Runway Status Light
SAFO	Safety Alerts For Operators
SAM	System Area Monitor
SAR	Search and Rescue
SAS	Stability Augmentation System
SATR	Special Air Traffic Rules
SBAS	Satellite-based Augmentation System
SCAT-1 DGPS	Special Category I Differential GPS
SDF	Simplified Directional Facility
SFL	Sequenced Flashing Lights
SFR	Special Flight Rules
SFRA	Special Flight Rules Area
SIAP	Standard Instrument Approach Procedure
SID	Standard Instrument Departure
SIGMET	Significant Meteorological Information
SM	Statute Mile
SMGCS	Surface Movement Guidance Control System
SNR	Signal-to-noise Ratio
SOIA	Simultaneous Offset Instrument Approaches
SOP	Standard Operating Procedure
SPC	Storm Prediction Center
SPS	Standard Positioning Service
STAR	Standard Terminal Arrival
STARS	Standard Terminal Automation Replacement System
STMP	Special Traffic Management Program
TA	Traffic Advisory
TAA	Terminal Arrival Area
TAC	Terminal Area Chart
TACAN	Tactical Air Navigation

Abbreviation/ Acronym	Meaning
TAF	Aerodrome Forecast
TAS	True Air Speed
TCAS	Traffic Alert and Collision Avoidance System
TCH	Threshold Crossing Height
TD	Time Difference
TDLS	Tower Data Link System
TDWR	Terminal Doppler Weather Radar
TDZ	Touchdown Zone
TDZE	Touchdown Zone Elevation
TDZL	Touchdown Zone Lights
TEC	Tower En Route Control
THL	Takeoff Hold Lights
TIBS	Telephone Information Briefing Service
TIS	Traffic Information Service
TIS-B	Traffic Information Service–Broadcast
TLS	Transponder Landing System
TPP	Terminal Procedures Publications
TRSA	Terminal Radar Service Area
TSO	Technical Standard Order
TWEB	Transcribed Weather Broadcast
TWIB	Terminal Weather Information for Pilots System
UA	Unmanned Aircraft
UAS	Unmanned Aircraft System
UAV	Unmanned Aerial Vehicle
UFO	Unidentified Flying Object
UHF	Ultrahigh Frequency
U.S.	United States
USCG	United States Coast Guard
UTC	Coordinated Universal Time
UWS	Urgent Weather SIGMET
VAR	Volcanic Activity Reporting
VASI	Visual Approach Slope Indicator
VCOA	Visual Climb Over the Airport
VDA	Vertical Descent Angle
VDP	Visual Descent Point
VFR	Visual Flight Rules
VGSI	Visual Glide Slope Indicator
VHF	Very High Frequency
VIP	Video Integrator Processor
VMC	Visual Meteorological Conditions
V _{MINI}	Instrument flight minimum speed, utilized in complying with minimum limit speed requirements for instrument flight
VNAV	Vertical Navigation
V _{NE}	Never exceed speed

Abbreviation/ Acronym	Meaning
V _{NEI}	Instrument flight never exceed speed, utilized instead of V _{NE} for compliance with maximum limit speed requirements for instrument flight
VOR	Very High Frequency Omni-directional Range
VORTAC . . .	VHF Omni-directional Range/Tactical Air Navigation
VOT	VOR Test Facility
VR	VFR Military Training Route
V _{REF}	The reference landing approach speed, usually about 1.3 times V _{SO} plus 50 percent of the wind gust speed in excess of the mean wind speed.
V _{SO}	The stalling speed or the minimum steady flight speed in the landing configuration at maximum weight.
VTF	Vector to Final
VV	Vertical Visibility
VVI	Vertical Velocity Indicator
V _Y	Speed for best rate of climb
V _{YI}	Instrument climb speed, utilized instead of V _Y for compliance with the climb requirements for instrument flight

Abbreviation/ Acronym	Meaning
WA	AIRMET
WAAS	Wide Area Augmentation System
WFO	Weather Forecast Office
WGS-84	World Geodetic System of 1984
WMO	World Meteorological Organization
WMS	Wide-Area Master Station
WMSC	Weather Message Switching Center
WMSCR	Weather Message Switching Center Replacement
WP	Waypoint
WRA	Weather Reconnaissance Area
WRS	Wide-Area Ground Reference Station
WS	SIGMET
WSO	Weather Service Office
WSP	Weather System Processor
WST	Convective Significant Meteorological Information
WW	Severe Weather Watch Bulletin

PILOT/CONTROLLER GLOSSARY

PURPOSE

a. This Glossary was compiled to promote a common understanding of the terms used in the Air Traffic Control system. It includes those terms which are intended for pilot/controller communications. Those terms most frequently used in pilot/controller communications are printed in *bold italics*. The definitions are primarily defined in an operational sense applicable to both users and operators of the National Airspace System. Use of the Glossary will preclude any misunderstandings concerning the system's design, function, and purpose.

b. Because of the international nature of flying, terms used in the Lexicon, published by the International Civil Aviation Organization (ICAO), are included when they differ from FAA definitions. These terms are followed by "[ICAO]." For the reader's convenience, there are also cross references to related terms in other parts of the Glossary and to other documents, such as the Code of Federal Regulations (CFR) and the Aeronautical Information Manual (AIM).

c. This Glossary will be revised, as necessary, to maintain a common understanding of the system.

EXPLANATION OF CHANGES

d. Terms Added:

AIRCRAFT WAKE TURBULENCE CATEGORIES
COMPUTER NAVIGATION FIX (CNF)
NAVSPEC (See NAVIGATION SPECIFICATION [ICAO])
PROPELLER (PROP) WASH (PROP BLAST)
ROTOR WASH
SATELLITE-BASED AUGMENTATION SYSTEM (SBAS)

e. Terms Deleted:

AUTOMATED WEATHER SENSOR SYSTEM (AWSS)

f. Terms Modified:

AUTOMATIC FLIGHT INFORMATION SERVICE (AFIS)
AUTOMATED WEATHER SYSTEM
JET BLAST
LOCAL AIRPORT ADVISORY (LAA)
ONE-MINUTE WEATHER
RADAR APPROACH CONTROL FACILITY
REQUIRED NAVIGATION PERFORMANCE (RNP)
TRACEABLE PRESSURE STANDARD
WAKE TURBULENCE

g. Editorial/format changes were made where necessary. Revision bars were not used due to the insignificant nature of the changes.

A

AAI-

(See ARRIVAL AIRCRAFT INTERVAL.)

AAR-

(See AIRPORT ARRIVAL RATE.)

ABBREVIATED IFR FLIGHT PLANS- An authorization by ATC requiring pilots to submit only that information needed for the purpose of ATC. It includes only a small portion of the usual IFR flight plan information. In certain instances, this may be only aircraft identification, location, and pilot request. Other information may be requested if needed by ATC for separation/control purposes. It is frequently used by aircraft which are airborne and desire an instrument approach or by aircraft which are on the ground and desire a climb to VFR-on-top.

(See VFR-ON-TOP.)

(Refer to AIM.)

ABEAM- An aircraft is “abeam” a fix, point, or object when that fix, point, or object is approximately 90 degrees to the right or left of the aircraft track. Abeam indicates a general position rather than a precise point.

ABORT- To terminate a preplanned aircraft maneuver; e.g., an aborted takeoff.

ACC [ICAO]-

(See ICAO term AREA CONTROL CENTER.)

ACCELERATE-STOP DISTANCE AVAILABLE-

The runway plus stopway length declared available and suitable for the acceleration and deceleration of an airplane aborting a takeoff.

ACCELERATE-STOP DISTANCE AVAILABLE

[ICAO]- The length of the take-off run available plus the length of the stopway if provided.

ACDO-

(See AIR CARRIER DISTRICT OFFICE.)

ACKNOWLEDGE- Let me know that you have received and understood this message.

ACL-

(See AIRCRAFT LIST.)

ACLS-

(See AUTOMATIC CARRIER LANDING SYSTEM.)

ACLT-

(See ACTUAL CALCULATED LANDING TIME.)

ACROBATIC FLIGHT- An intentional maneuver involving an abrupt change in an aircraft’s attitude, an abnormal attitude, or abnormal acceleration not necessary for normal flight.

(See ICAO term ACROBATIC FLIGHT.)

(Refer to 14 CFR Part 91.)

ACROBATIC FLIGHT [ICAO]- Maneuvers intentionally performed by an aircraft involving an abrupt change in its attitude, an abnormal attitude, or an abnormal variation in speed.

ACTIVE RUNWAY-

(See RUNWAY IN USE/ACTIVE RUNWAY/DUTY RUNWAY.)

ACTUAL CALCULATED LANDING TIME-

ACLT is a flight’s frozen calculated landing time. An actual time determined at freeze calculated landing time (FCLT) or meter list display interval (MLDI) for the adapted vertex for each arrival aircraft based upon runway configuration, airport acceptance rate, airport arrival delay period, and other metered arrival aircraft. This time is either the vertex time of arrival (VTA) of the aircraft or the tentative calculated landing time (TCLT)/ACLT of the previous aircraft plus the arrival aircraft interval (AAI), whichever is later. This time will not be updated in response to the aircraft’s progress.

ACTUAL NAVIGATION PERFORMANCE (ANP)-

(See REQUIRED NAVIGATION PERFORMANCE.)

ADDITIONAL SERVICES- Advisory information provided by ATC which includes but is not limited to the following:

a. Traffic advisories.

b. Vectors, when requested by the pilot, to assist aircraft receiving traffic advisories to avoid observed traffic.

c. Altitude deviation information of 300 feet or more from an assigned altitude as observed on a verified (reading correctly) automatic altitude readout (Mode C).

d. Advisories that traffic is no longer a factor.

e. Weather and chaff information.

f. Weather assistance.

g. Bird activity information.

h. Holding pattern surveillance. Additional services are provided to the extent possible contingent only upon the controller's capability to fit them into the performance of higher priority duties and on the basis of limitations of the radar, volume of traffic, frequency congestion, and controller workload. The controller has complete discretion for determining if he/she is able to provide or continue to provide a service in a particular case. The controller's reason not to provide or continue to provide a service in a particular case is not subject to question by the pilot and need not be made known to him/her.
(See TRAFFIC ADVISORIES.)
(Refer to AIM.)

ADF–
(See AUTOMATIC DIRECTION FINDER.)

ADIZ–
(See AIR DEFENSE IDENTIFICATION ZONE.)

ADLY–
(See ARRIVAL DELAY.)

ADMINISTRATOR– The Federal Aviation Administrator or any person to whom he/she has delegated his/her authority in the matter concerned.

ADR–
(See AIRPORT DEPARTURE RATE.)

ADS [ICAO]–
(See ICAO term AUTOMATIC DEPENDENT SURVEILLANCE.)

ADS-B–
(See AUTOMATIC DEPENDENT SURVEILLANCE–BROADCAST.)

ADS-C–
(See AUTOMATIC DEPENDENT SURVEILLANCE–CONTRACT.)

ADVISE INTENTIONS– Tell me what you plan to do.

ADVISORY– Advice and information provided to assist pilots in the safe conduct of flight and aircraft movement.
(See ADVISORY SERVICE.)

ADVISORY FREQUENCY– The appropriate frequency to be used for Airport Advisory Service.
(See LOCAL AIRPORT ADVISORY.)
(See UNICOM.)
(Refer to ADVISORY CIRCULAR NO. 90-42.)
(Refer to AIM.)

ADVISORY SERVICE– Advice and information provided by a facility to assist pilots in the safe conduct of flight and aircraft movement.
(See ADDITIONAL SERVICES.)
(See LOCAL AIRPORT ADVISORY.)
(See RADAR ADVISORY.)
(See SAFETY ALERT.)
(See TRAFFIC ADVISORIES.)
(Refer to AIM.)

AERIAL REFUELING– A procedure used by the military to transfer fuel from one aircraft to another during flight.
(Refer to VFR/IFR Wall Planning Charts.)

AERODROME– A defined area on land or water (including any buildings, installations and equipment) intended to be used either wholly or in part for the arrival, departure, and movement of aircraft.

AERODROME BEACON [ICAO]– Aeronautical beacon used to indicate the location of an aerodrome from the air.

AERODROME CONTROL SERVICE [ICAO]– Air traffic control service for aerodrome traffic.

AERODROME CONTROL TOWER [ICAO]– A unit established to provide air traffic control service to aerodrome traffic.

AERODROME ELEVATION [ICAO]– The elevation of the highest point of the landing area.

AERODROME TRAFFIC CIRCUIT [ICAO]– The specified path to be flown by aircraft operating in the vicinity of an aerodrome.

AERONAUTICAL BEACON– A visual NAVAID displaying flashes of white and/or colored light to indicate the location of an airport, a heliport, a landmark, a certain point of a Federal airway in mountainous terrain, or an obstruction.
(See AIRPORT ROTATING BEACON.)
(Refer to AIM.)

AERONAUTICAL CHART– A map used in air navigation containing all or part of the following: topographic features, hazards and obstructions,

navigation aids, navigation routes, designated airspace, and airports. Commonly used aeronautical charts are:

a. Sectional Aeronautical Charts (1:500,000)– Designed for visual navigation of slow or medium speed aircraft. Topographic information on these charts features the portrayal of relief and a judicious selection of visual check points for VFR flight. Aeronautical information includes visual and radio aids to navigation, airports, controlled airspace, permanent special use airspace (SUA), obstructions, and related data.

b. VFR Terminal Area Charts (1:250,000)– Depict Class B airspace which provides for the control or segregation of all the aircraft within Class B airspace. The chart depicts topographic information and aeronautical information which includes visual and radio aids to navigation, airports, controlled airspace, permanent SUA, obstructions, and related data.

c. En Route Low Altitude Charts– Provide aeronautical information for en route instrument navigation (IFR) in the low altitude stratum. Information includes the portrayal of airways, limits of controlled airspace, position identification and frequencies of radio aids, selected airports, minimum en route and minimum obstruction clearance altitudes, airway distances, reporting points, permanent SUA, and related data. Area charts, which are a part of this series, furnish terminal data at a larger scale in congested areas.

d. En Route High Altitude Charts– Provide aeronautical information for en route instrument navigation (IFR) in the high altitude stratum. Information includes the portrayal of jet routes, identification and frequencies of radio aids, selected airports, distances, time zones, special use airspace, and related information.

e. Instrument Approach Procedure (IAP) Charts– Portray the aeronautical data which is required to execute an instrument approach to an airport. These charts depict the procedures, including all related data, and the airport diagram. Each procedure is designated for use with a specific type of electronic navigation system including NDB, TACAN, VOR, ILS RNAV and GLS. These charts are identified by the type of navigational aid(s)/equipment required to provide final approach guidance.

f. Instrument Departure Procedure (DP) Charts– Designed to expedite clearance delivery and to facilitate transition between takeoff and en route operations. Each DP is presented as a separate chart and may serve a single airport or more than one airport in a given geographical location.

g. Standard Terminal Arrival (STAR) Charts– Designed to expedite air traffic control arrival procedures and to facilitate transition between en route and instrument approach operations. Each STAR procedure is presented as a separate chart and may serve a single airport or more than one airport in a given geographical location.

h. Airport Taxi Charts– Designed to expedite the efficient and safe flow of ground traffic at an airport. These charts are identified by the official airport name; e.g., Ronald Reagan Washington National Airport.

(See ICAO term AERONAUTICAL CHART.)

AERONAUTICAL CHART [ICAO]– A representation of a portion of the earth, its culture and relief, specifically designated to meet the requirements of air navigation.

AERONAUTICAL INFORMATION MANUAL (AIM)– A primary FAA publication whose purpose is to instruct airmen about operating in the National Airspace System of the U.S. It provides basic flight information, ATC Procedures and general instructional information concerning health, medical facts, factors affecting flight safety, accident and hazard reporting, and types of aeronautical charts and their use.

AERONAUTICAL INFORMATION PUBLICATION (AIP) [ICAO]– A publication issued by or with the authority of a State and containing aeronautical information of a lasting character essential to air navigation.

(See CHART SUPPLEMENT U.S.)

AFFIRMATIVE– Yes.

AFIS–

(See AUTOMATIC FLIGHT INFORMATION SERVICE – ALASKA FSSs ONLY.)

AFP–

(See AIRSPACE FLOW PROGRAM.)

AIM–

(See AERONAUTICAL INFORMATION MANUAL.)

AIP [ICAO]–

(See ICAO term AERONAUTICAL INFORMATION PUBLICATION.)

AIR CARRIER DISTRICT OFFICE– An FAA field office serving an assigned geographical area, staffed with Flight Standards personnel serving the aviation industry and the general public on matters related to the certification and operation of scheduled air carriers and other large aircraft operations.

AIR DEFENSE EMERGENCY– A military emergency condition declared by a designated authority. This condition exists when an attack upon the continental U.S., Alaska, Canada, or U.S. installations in Greenland by hostile aircraft or missiles is considered probable, is imminent, or is taking place.

(Refer to AIM.)

AIR DEFENSE IDENTIFICATION ZONE (ADIZ)– An area of airspace over land or water in which the ready identification, location, and control of all aircraft (except for Department of Defense and law enforcement aircraft) is required in the interest of national security.

Note: ADIZ locations and operating and flight plan requirements for civil aircraft operations are specified in 14 CFR Part 99.

(Refer to AIM.)

AIR NAVIGATION FACILITY– Any facility used in, available for use in, or designed for use in, aid of air navigation, including landing areas, lights, any apparatus or equipment for disseminating weather information, for signaling, for radio-directional finding, or for radio or other electrical communication, and any other structure or mechanism having a similar purpose for guiding or controlling flight in the air or the landing and takeoff of aircraft.

(See NAVIGATIONAL AID.)

AIR ROUTE SURVEILLANCE RADAR– Air route traffic control center (ARTCC) radar used primarily to detect and display an aircraft's position while en route between terminal areas. The ARSR enables controllers to provide radar air traffic control service when aircraft are within the ARSR coverage. In some instances, ARSR may enable an ARTCC to provide terminal radar services similar to but usually more limited than those provided by a radar approach control.

AIR ROUTE TRAFFIC CONTROL CENTER (ARTCC)– A facility established to provide air traffic control service to aircraft operating on IFR flight plans within controlled airspace and principally during the en route phase of flight. When equipment capabilities and controller workload permit, certain advisory/assistance services may be provided to VFR aircraft.

(See EN ROUTE AIR TRAFFIC CONTROL SERVICES.)

(Refer to AIM.)

AIR TAXI– Used to describe a helicopter/VTOL aircraft movement conducted above the surface but normally not above 100 feet AGL. The aircraft may proceed either via hover taxi or flight at speeds more than 20 knots. The pilot is solely responsible for selecting a safe airspeed/altitude for the operation being conducted.

(See HOVER TAXI.)

(Refer to AIM.)

AIR TRAFFIC– Aircraft operating in the air or on an airport surface, exclusive of loading ramps and parking areas.

(See ICAO term AIR TRAFFIC.)

AIR TRAFFIC [ICAO]– All aircraft in flight or operating on the maneuvering area of an aerodrome.

AIR TRAFFIC CLEARANCE– An authorization by air traffic control for the purpose of preventing collision between known aircraft, for an aircraft to proceed under specified traffic conditions within controlled airspace. The pilot-in-command of an aircraft may not deviate from the provisions of a visual flight rules (VFR) or instrument flight rules (IFR) air traffic clearance except in an emergency or unless an amended clearance has been obtained. Additionally, the pilot may request a different clearance from that which has been issued by air traffic control (ATC) if information available to the pilot makes another course of action more practicable or if aircraft equipment limitations or company procedures forbid compliance with the clearance issued. Pilots may also request clarification or amendment, as appropriate, any time a clearance is not fully understood, or considered unacceptable because of safety of flight. Controllers should, in such instances and to the extent of operational practicality and safety, honor the pilot's request. 14 CFR Part 91.3(a) states: "The pilot in command of an aircraft is directly responsible for, and is the

final authority as to, the operation of that aircraft.”
THE PILOT IS RESPONSIBLE TO REQUEST AN AMENDED CLEARANCE if ATC issues a clearance that would cause a pilot to deviate from a rule or regulation, or in the pilot’s opinion, would place the aircraft in jeopardy.

(See ATC INSTRUCTIONS.)

(See ICAO term AIR TRAFFIC CONTROL CLEARANCE.)

AIR TRAFFIC CONTROL– A service operated by appropriate authority to promote the safe, orderly and expeditious flow of air traffic.

(See ICAO term AIR TRAFFIC CONTROL SERVICE.)

AIR TRAFFIC CONTROL CLEARANCE [ICAO]– Authorization for an aircraft to proceed under conditions specified by an air traffic control unit.

Note 1: For convenience, the term air traffic control clearance is frequently abbreviated to clearance when used in appropriate contexts.

Note 2: The abbreviated term clearance may be prefixed by the words taxi, takeoff, departure, en route, approach or landing to indicate the particular portion of flight to which the air traffic control clearance relates.

AIR TRAFFIC CONTROL SERVICE–

(See AIR TRAFFIC CONTROL.)

AIR TRAFFIC CONTROL SERVICE [ICAO]– A service provided for the purpose of:

- a. Preventing collisions:
 1. Between aircraft; and
 2. On the maneuvering area between aircraft and obstructions.
- b. Expediting and maintaining an orderly flow of air traffic.

AIR TRAFFIC CONTROL SPECIALIST– A person authorized to provide air traffic control service.

(See AIR TRAFFIC CONTROL.)

(See FLIGHT SERVICE STATION.)

(See ICAO term CONTROLLER.)

AIR TRAFFIC CONTROL SYSTEM COMMAND CENTER (ATCSCC)– An Air Traffic Tactical Operations facility responsible for monitoring and managing the flow of air traffic throughout the NAS, producing a safe, orderly, and expeditious flow of traffic while minimizing delays. The following functions are located at the ATCSCC:

- a. **Central Altitude Reservation Function (CARF)**. Responsible for coordinating, planning, and approving special user requirements under the Altitude Reservation (ALTRV) concept.

(See ALTITUDE RESERVATION.)

- b. **Airport Reservation Office (ARO)**. Monitors the operation and allocation of reservations for unscheduled operations at airports designated by the Administrator as High Density Airports. These airports are generally known as slot controlled airports. The ARO allocates reservations on a first come, first served basis determined by the time the request is received at the ARO.

(Refer to 14 CFR Part 93.)

(See CHART SUPPLEMENT U.S.)

- c. **U.S. Notice to Airmen (NOTAM) Office**. Responsible for collecting, maintaining, and distributing NOTAMs for the U.S. civilian and military, as well as international aviation communities.

(See NOTICE TO AIRMEN.)

- d. **Weather Unit**. Monitor all aspects of weather for the U.S. that might affect aviation including cloud cover, visibility, winds, precipitation, thunderstorms, icing, turbulence, and more. Provide forecasts based on observations and on discussions with meteorologists from various National Weather Service offices, FAA facilities, airlines, and private weather services.

AIR TRAFFIC SERVICE– A generic term meaning:

- a. Flight Information Service.
- b. Alerting Service.
- c. Air Traffic Advisory Service.
- d. Air Traffic Control Service:
 1. Area Control Service,
 2. Approach Control Service, or
 3. Airport Control Service.

AIR TRAFFIC SERVICE (ATS) ROUTES – The term “ATS Route” is a generic term that includes “VOR Federal airways,” “colored Federal airways,” “jet routes,” and “RNAV routes.” The term “ATS route” does not replace these more familiar route names, but serves only as an overall title when listing the types of routes that comprise the United States route structure.

AIRBORNE– An aircraft is considered airborne when all parts of the aircraft are off the ground.

AIRBORNE DELAY– Amount of delay to be encountered in airborne holding.

AIRCRAFT– Device(s) that are used or intended to be used for flight in the air, and when used in air traffic control terminology, may include the flight crew.

(See ICAO term AIRCRAFT.)

AIRCRAFT [ICAO]– Any machine that can derive support in the atmosphere from the reactions of the air other than the reactions of the air against the earth's surface.

AIRCRAFT APPROACH CATEGORY– A grouping of aircraft based on a speed of 1.3 times the stall speed in the landing configuration at maximum gross landing weight. An aircraft must fit in only one category. If it is necessary to maneuver at speeds in excess of the upper limit of a speed range for a category, the minimums for the category for that speed must be used. For example, an aircraft which falls in Category A, but is circling to land at a speed in excess of 91 knots, must use the approach Category B minimums when circling to land. The categories are as follows:

- a. Category A– Speed less than 91 knots.
 - b. Category B– Speed 91 knots or more but less than 121 knots.
 - c. Category C– Speed 121 knots or more but less than 141 knots.
 - d. Category D– Speed 141 knots or more but less than 166 knots.
 - e. Category E– Speed 166 knots or more.
- (Refer to 14 CFR Part 97.)

AIRCRAFT CLASSES– For the purposes of Wake Turbulence Separation Minima, ATC classifies aircraft as Super, Heavy, Large, and Small as follows:

- a. Super. The Airbus A-380-800 (A388) and the Antonov An-225 (A225) are classified as super.
 - b. Heavy– Aircraft capable of takeoff weights of 300,000 pounds or more whether or not they are operating at this weight during a particular phase of flight.
 - c. Large– Aircraft of more than 41,000 pounds, maximum certificated takeoff weight, up to but not including 300,000 pounds.
 - d. Small– Aircraft of 41,000 pounds or less maximum certificated takeoff weight.
- (Refer to AIM.)

AIRCRAFT CONFLICT– Predicted conflict, within EDST of two aircraft, or between aircraft and airspace. A Red alert is used for conflicts when the predicted minimum separation is 5 nautical miles or less. A Yellow alert is used when the predicted minimum separation is between 5 and approximately 12 nautical miles. A Blue alert is used for conflicts between an aircraft and predefined airspace.

(See EN ROUTE DECISION SUPPORT TOOL.)

AIRCRAFT LIST (ACL)– A view available with EDST that lists aircraft currently in or predicted to be in a particular sector's airspace. The view contains textual flight data information in line format and may be sorted into various orders based on the specific needs of the sector team.

(See EN ROUTE DECISION SUPPORT TOOL.)

AIRCRAFT SURGE LAUNCH AND RECOVERY– Procedures used at USAF bases to provide increased launch and recovery rates in instrument flight rules conditions. ASLAR is based on:

- a. Reduced separation between aircraft which is based on time or distance. Standard arrival separation applies between participants including multiple flights until the DRAG point. The DRAG point is a published location on an ASLAR approach where aircraft landing second in a formation slows to a predetermined airspeed. The DRAG point is the reference point at which MARSAs applies as expanding elements effect separation within a flight or between subsequent participating flights.
- b. ASLAR procedures shall be covered in a Letter of Agreement between the responsible USAF military ATC facility and the concerned Federal Aviation Administration facility. Initial Approach Fix spacing requirements are normally addressed as a minimum.

AIRCRAFT WAKE TURBULENCE CATEGORIES– For the purpose of Wake Turbulence Recategorization (RECAT) Separation Minima, ATC groups aircraft into categories ranging from Category A through Category I, dependent upon the version of RECAT that is applied. Specific category assignments vary and are listed in the RECAT Orders.

AIRMEN'S METEOROLOGICAL INFORMATION (AIRMET)– In-flight weather advisories issued only to amend the Aviation Surface Forecast,

Aviation Cloud Forecast, or area forecast concerning weather phenomena which are of operational interest to all aircraft and potentially hazardous to aircraft having limited capability because of lack of equipment, instrumentation, or pilot qualifications. AIRMETs concern weather of less severity than that covered by SIGMETs or Convective SIGMETs. AIRMETs cover moderate icing, moderate turbulence, sustained winds of 30 knots or more at the surface, widespread areas of ceilings less than 1,000 feet and/or visibility less than 3 miles, and extensive mountain obscurement.

(See AWW.)

(See CONVECTIVE SIGMET.)

(See CWA.)

(See SIGMET.)

(Refer to AIM.)

AIRPORT– An area on land or water that is used or intended to be used for the landing and takeoff of aircraft and includes its buildings and facilities, if any.

AIRPORT ADVISORY AREA– The area within ten miles of an airport without a control tower or where the tower is not in operation, and on which a Flight Service Station is located.

(See LOCAL AIRPORT ADVISORY.)

(Refer to AIM.)

AIRPORT ARRIVAL RATE (AAR)– A dynamic input parameter specifying the number of arriving aircraft which an airport or airspace can accept from the ARTCC per hour. The AAR is used to calculate the desired interval between successive arrival aircraft.

AIRPORT DEPARTURE RATE (ADR)– A dynamic parameter specifying the number of aircraft which can depart an airport and the airspace can accept per hour.

AIRPORT ELEVATION– The highest point of an airport's usable runways measured in feet from mean sea level.

(See TOUCHDOWN ZONE ELEVATION.)

(See ICAO term AERODROME ELEVATION.)

AIRPORT LIGHTING– Various lighting aids that may be installed on an airport. Types of airport lighting include:

a. Approach Light System (ALS)– An airport lighting facility which provides visual guidance to

landing aircraft by radiating light beams in a directional pattern by which the pilot aligns the aircraft with the extended centerline of the runway on his/her final approach for landing. Condenser-Discharge Sequential Flashing Lights/Sequenced Flashing Lights may be installed in conjunction with the ALS at some airports. Types of Approach Light Systems are:

1. ALSF-1– Approach Light System with Sequenced Flashing Lights in ILS Cat-I configuration.

2. ALSF-2– Approach Light System with Sequenced Flashing Lights in ILS Cat-II configuration. The ALSF-2 may operate as an SSALR when weather conditions permit.

3. SSALF– Simplified Short Approach Light System with Sequenced Flashing Lights.

4. SSALR– Simplified Short Approach Light System with Runway Alignment Indicator Lights.

5. MALSF– Medium Intensity Approach Light System with Sequenced Flashing Lights.

6. MALSR– Medium Intensity Approach Light System with Runway Alignment Indicator Lights.

7. RLLS– Runway Lead-in Light System Consists of one or more series of flashing lights installed at or near ground level that provides positive visual guidance along an approach path, either curving or straight, where special problems exist with hazardous terrain, obstructions, or noise abatement procedures.

8. RAIL– Runway Alignment Indicator Lights– Sequenced Flashing Lights which are installed only in combination with other light systems.

9. ODALS– Omnidirectional Approach Lighting System consists of seven omnidirectional flashing lights located in the approach area of a nonprecision runway. Five lights are located on the runway centerline extended with the first light located 300 feet from the threshold and extending at equal intervals up to 1,500 feet from the threshold. The other two lights are located, one on each side of the runway threshold, at a lateral distance of 40 feet from the runway edge, or 75 feet from the runway edge when installed on a runway equipped with a VASI.

(Refer to FAA Order JO 6850.2, VISUAL GUIDANCE LIGHTING SYSTEMS.)

b. Runway Lights/Runway Edge Lights– Lights having a prescribed angle of emission used to define

the lateral limits of a runway. Runway lights are uniformly spaced at intervals of approximately 200 feet, and the intensity may be controlled or preset.

c. Touchdown Zone Lighting– Two rows of transverse light bars located symmetrically about the runway centerline normally at 100 foot intervals. The basic system extends 3,000 feet along the runway.

d. Runway Centerline Lighting– Flush centerline lights spaced at 50-foot intervals beginning 75 feet from the landing threshold and extending to within 75 feet of the opposite end of the runway.

e. Threshold Lights– Fixed green lights arranged symmetrically left and right of the runway centerline, identifying the runway threshold.

f. Runway End Identifier Lights (REIL)– Two synchronized flashing lights, one on each side of the runway threshold, which provide rapid and positive identification of the approach end of a particular runway.

g. Visual Approach Slope Indicator (VASI)– An airport lighting facility providing vertical visual approach slope guidance to aircraft during approach to landing by radiating a directional pattern of high intensity red and white focused light beams which indicate to the pilot that he/she is “on path” if he/she sees red/white, “above path” if white/white, and “below path” if red/red. Some airports serving large aircraft have three-bar VASIs which provide two visual glide paths to the same runway.

h. Precision Approach Path Indicator (PAPI)– An airport lighting facility, similar to VASI, providing vertical approach slope guidance to aircraft during approach to landing. PAPIs consist of a single row of either two or four lights, normally installed on the left side of the runway, and have an effective visual range of about 5 miles during the day and up to 20 miles at night. PAPIs radiate a directional pattern of high intensity red and white focused light beams which indicate that the pilot is “on path” if the pilot sees an equal number of white lights and red lights, with white to the left of the red; “above path” if the pilot sees more white than red lights; and “below path” if the pilot sees more red than white lights.

i. Boundary Lights– Lights defining the perimeter of an airport or landing area.

(Refer to AIM.)

AIRPORT MARKING AIDS– Markings used on runway and taxiway surfaces to identify a specific runway, a runway threshold, a centerline, a hold line,

etc. A runway should be marked in accordance with its present usage such as:

- a. Visual.**
- b. Nonprecision instrument.**
- c. Precision instrument.**

(Refer to AIM.)

AIRPORT REFERENCE POINT (ARP)– The approximate geometric center of all usable runway surfaces.

AIRPORT RESERVATION OFFICE– Office responsible for monitoring the operation of slot controlled airports. It receives and processes requests for unscheduled operations at slot controlled airports.

AIRPORT ROTATING BEACON– A visual NAVAID operated at many airports. At civil airports, alternating white and green flashes indicate the location of the airport. At military airports, the beacons flash alternately white and green, but are differentiated from civil beacons by dualpeaked (two quick) white flashes between the green flashes.

(See INSTRUMENT FLIGHT RULES.)

(See SPECIAL VFR OPERATIONS.)

(See ICAO term AERODROME BEACON.)

(Refer to AIM.)

AIRPORT STREAM FILTER (ASF)– An on/off filter that allows the conflict notification function to be inhibited for arrival streams into single or multiple airports to prevent nuisance alerts.

AIRPORT SURFACE DETECTION EQUIPMENT (ASDE)– Surveillance equipment specifically designed to detect aircraft, vehicular traffic, and other objects, on the surface of an airport, and to present the image on a tower display. Used to augment visual observation by tower personnel of aircraft and/or vehicular movements on runways and taxiways. There are three ASDE systems deployed in the NAS:

a. ASDE-3– a Surface Movement Radar.

b. ASDE-X– a system that uses an X-band Surface Movement Radar, multilateration, and ADS-B.

c. Airport Surface Surveillance Capability (ASSC)– A system that uses Surface Movement Radar, multilateration, and ADS-B.

AIRPORT SURVEILLANCE RADAR– Approach control radar used to detect and display an aircraft’s position in the terminal area. ASR provides range and azimuth information but does not provide elevation data. Coverage of the ASR can extend up to 60 miles.

AIRPORT TAXI CHARTS–

(See AERONAUTICAL CHART.)

AIRPORT TRAFFIC CONTROL SERVICE– A service provided by a control tower for aircraft operating on the movement area and in the vicinity of an airport.

(See MOVEMENT AREA.)

(See TOWER.)

(See ICAO term AERODROME CONTROL SERVICE.)

AIRPORT TRAFFIC CONTROL TOWER–

(See TOWER.)

AIRSPACE CONFLICT– Predicted conflict of an aircraft and active Special Activity Airspace (SAA).

AIRSPACE FLOW PROGRAM (AFP)– AFP is a Traffic Management (TM) process administered by the Air Traffic Control System Command Center (ATCSCC) where aircraft are assigned an Expect Departure Clearance Time (EDCT) in order to manage capacity and demand for a specific area of the National Airspace System (NAS). The purpose of the program is to mitigate the effects of en route constraints. It is a flexible program and may be implemented in various forms depending upon the needs of the air traffic system.

AIRSPACE HIERARCHY– Within the airspace classes, there is a hierarchy and, in the event of an overlap of airspace: Class A preempts Class B, Class B preempts Class C, Class C preempts Class D, Class D preempts Class E, and Class E preempts Class G.

AIRSPEED– The speed of an aircraft relative to its surrounding air mass. The unqualified term “airspeed” means one of the following:

a. Indicated Airspeed– The speed shown on the aircraft airspeed indicator. This is the speed used in pilot/controller communications under the general term “airspeed.”

(Refer to 14 CFR Part 1.)

b. True Airspeed– The airspeed of an aircraft relative to undisturbed air. Used primarily in flight planning and en route portion of flight. When used in pilot/controller communications, it is referred to as “true airspeed” and not shortened to “airspeed.”

AIRSTART– The starting of an aircraft engine while the aircraft is airborne, preceded by engine shutdown during training flights or by actual engine failure.

AIRWAY– A Class E airspace area established in the form of a corridor, the centerline of which is defined by radio navigational aids.

(See FEDERAL AIRWAYS.)

(See ICAO term AIRWAY.)

(Refer to 14 CFR Part 71.)

(Refer to AIM.)

AIRWAY [ICAO]– A control area or portion thereof established in the form of corridor equipped with radio navigational aids.

AIRWAY BEACON– Used to mark airway segments in remote mountain areas. The light flashes Morse Code to identify the beacon site.

(Refer to AIM.)

AIT–

(See AUTOMATED INFORMATION TRANSFER.)

ALERFA (Alert Phase) [ICAO]– A situation wherein apprehension exists as to the safety of an aircraft and its occupants.

ALERT– A notification to a position that there is an aircraft-to-aircraft or aircraft-to-airspace conflict, as detected by Automated Problem Detection (APD).

ALERT AREA–

(See SPECIAL USE AIRSPACE.)

ALERT NOTICE (ALNOT)– A request originated by a flight service station (FSS) or an air route traffic control center (ARTCC) for an extensive communication search for overdue, unreported, or missing aircraft.

ALERTING SERVICE– A service provided to notify appropriate organizations regarding aircraft in need of search and rescue aid and assist such organizations as required.

ALNOT–

(See ALERT NOTICE.)

ALONG–TRACK DISTANCE (ATD)– The horizontal distance between the aircraft’s current position and a fix measured by an area navigation system that is not subject to slant range errors.

ALPHANUMERIC DISPLAY– Letters and numerals used to show identification, altitude, beacon code, and other information concerning a target on a radar display.

(See AUTOMATED RADAR TERMINAL SYSTEMS.)

ALTERNATE AERODROME [ICAO]– An aerodrome to which an aircraft may proceed when it becomes either impossible or inadvisable to proceed to or to land at the aerodrome of intended landing.

Note: The aerodrome from which a flight departs may also be an en-route or a destination alternate aerodrome for the flight.

ALTERNATE AIRPORT– An airport at which an aircraft may land if a landing at the intended airport becomes inadvisable.

(See ICAO term ALTERNATE AERODROME.)

ALTIMETER SETTING– The barometric pressure reading used to adjust a pressure altimeter for variations in existing atmospheric pressure or to the standard altimeter setting (29.92).

(Refer to 14 CFR Part 91.)

(Refer to AIM.)

ALTITUDE– The height of a level, point, or object measured in feet Above Ground Level (AGL) or from Mean Sea Level (MSL).

(See FLIGHT LEVEL.)

a. MSL Altitude– Altitude expressed in feet measured from mean sea level.

b. AGL Altitude– Altitude expressed in feet measured above ground level.

c. Indicated Altitude– The altitude as shown by an altimeter. On a pressure or barometric altimeter it is altitude as shown uncorrected for instrument error and uncompensated for variation from standard atmospheric conditions.

(See ICAO term ALTITUDE.)

ALTITUDE [ICAO]– The vertical distance of a level, a point or an object considered as a point, measured from mean sea level (MSL).

ALTITUDE READOUT– An aircraft's altitude, transmitted via the Mode C transponder feature, that is visually displayed in 100-foot increments on a radar scope having readout capability.

(See ALPHANUMERIC DISPLAY.)

(See AUTOMATED RADAR TERMINAL SYSTEMS.)

(Refer to AIM.)

ALTITUDE RESERVATION (ALTRV)– Airspace utilization under prescribed conditions normally employed for the mass movement of aircraft or other special user requirements which cannot otherwise be

accomplished. ALTRVs are approved by the appropriate FAA facility.

(See AIR TRAFFIC CONTROL SYSTEM COMMAND CENTER.)

ALTITUDE RESTRICTION– An altitude or altitudes, stated in the order flown, which are to be maintained until reaching a specific point or time. Altitude restrictions may be issued by ATC due to traffic, terrain, or other airspace considerations.

ALTITUDE RESTRICTIONS ARE CANCELED– Adherence to previously imposed altitude restrictions is no longer required during a climb or descent.

ALTRV–

(See ALTITUDE RESERVATION.)

AMVER–

(See AUTOMATED MUTUAL-ASSISTANCE VESSEL RESCUE SYSTEM.)

APB–

(See AUTOMATED PROBLEM DETECTION BOUNDARY.)

APD–

(See AUTOMATED PROBLEM DETECTION.)

APDIA–

(See AUTOMATED PROBLEM DETECTION INHIBITED AREA.)

APPROACH CLEARANCE– Authorization by ATC for a pilot to conduct an instrument approach. The type of instrument approach for which a clearance and other pertinent information is provided in the approach clearance when required.

(See CLEARED APPROACH.)

(See INSTRUMENT APPROACH PROCEDURE.)

(Refer to AIM.)

(Refer to 14 CFR Part 91.)

APPROACH CONTROL FACILITY– A terminal ATC facility that provides approach control service in a terminal area.

(See APPROACH CONTROL SERVICE.)

(See RADAR APPROACH CONTROL FACILITY.)

APPROACH CONTROL SERVICE– Air traffic control service provided by an approach control facility for arriving and departing VFR/IFR aircraft and, on occasion, en route aircraft. At some airports

not served by an approach control facility, the ARTCC provides limited approach control service.

(See ICAO term **APPROACH CONTROL SERVICE**.)

(Refer to AIM.)

APPROACH CONTROL SERVICE [ICAO]– Air traffic control service for arriving or departing controlled flights.

APPROACH GATE– An imaginary point used within ATC as a basis for vectoring aircraft to the final approach course. The gate will be established along the final approach course 1 mile from the final approach fix on the side away from the airport and will be no closer than 5 miles from the landing threshold.

APPROACH/DEPARTURE HOLD AREA– The locations on taxiways in the approach or departure areas of a runway designated to protect landing or departing aircraft. These locations are identified by signs and markings.

APPROACH LIGHT SYSTEM–

(See **AIRPORT LIGHTING**.)

APPROACH SEQUENCE– The order in which aircraft are positioned while on approach or awaiting approach clearance.

(See **LANDING SEQUENCE**.)

(See ICAO term **APPROACH SEQUENCE**.)

APPROACH SEQUENCE [ICAO]– The order in which two or more aircraft are cleared to approach to land at the aerodrome.

APPROACH SPEED– The recommended speed contained in aircraft manuals used by pilots when making an approach to landing. This speed will vary for different segments of an approach as well as for aircraft weight and configuration.

APPROACH WITH VERTICAL GUIDANCE (APV)– A term used to describe RNAV approach procedures that provide lateral and vertical guidance but do not meet the requirements to be considered a precision approach.

APPROPRIATE ATS AUTHORITY [ICAO]– The relevant authority designated by the State responsible for providing air traffic services in the airspace concerned. In the United States, the “appropriate ATS authority” is the Program Director for Air Traffic Planning and Procedures, ATP-1.

APPROPRIATE AUTHORITY–

a. Regarding flight over the high seas: the relevant authority is the State of Registry.

b. Regarding flight over other than the high seas: the relevant authority is the State having sovereignty over the territory being overflown.

APPROPRIATE OBSTACLE CLEARANCE

MINIMUM ALTITUDE– Any of the following:

(See **MINIMUM EN ROUTE IFR ALTITUDE**.)

(See **MINIMUM IFR ALTITUDE**.)

(See **MINIMUM OBSTRUCTION CLEARANCE ALTITUDE**.)

(See **MINIMUM VECTORING ALTITUDE**.)

APPROPRIATE TERRAIN CLEARANCE

MINIMUM ALTITUDE– Any of the following:

(See **MINIMUM EN ROUTE IFR ALTITUDE**.)

(See **MINIMUM IFR ALTITUDE**.)

(See **MINIMUM OBSTRUCTION CLEARANCE ALTITUDE**.)

(See **MINIMUM VECTORING ALTITUDE**.)

APRON– A defined area on an airport or heliport intended to accommodate aircraft for purposes of loading or unloading passengers or cargo, refueling, parking, or maintenance. With regard to seaplanes, a ramp is used for access to the apron from the water.

(See ICAO term **APRON**.)

APRON [ICAO]– A defined area, on a land aerodrome, intended to accommodate aircraft for purposes of loading or unloading passengers, mail or cargo, refueling, parking or maintenance.

ARC– The track over the ground of an aircraft flying at a constant distance from a navigational aid by reference to distance measuring equipment (DME).

AREA CONTROL CENTER [ICAO]– An air traffic control facility primarily responsible for ATC services being provided IFR aircraft during the en route phase of flight. The U.S. equivalent facility is an air route traffic control center (ARTCC).

AREA NAVIGATION (RNAV)– A method of navigation which permits aircraft operation on any desired flight path within the coverage of ground– or space–based navigation aids or within the limits of the capability of self-contained aids, or a combination of these.

Note: Area navigation includes performance–based navigation as well as other operations that do not meet the definition of performance–based navigation.

AREA NAVIGATION (RNAV) APPROACH CONFIGURATION:

a. STANDARD T– An RNAV approach whose design allows direct flight to any one of three initial approach fixes (IAF) and eliminates the need for procedure turns. The standard design is to align the procedure on the extended centerline with the missed approach point (MAP) at the runway threshold, the final approach fix (FAF), and the initial approach/intermediate fix (IAF/IF). The other two IAFs will be established perpendicular to the IF.

b. MODIFIED T– An RNAV approach design for single or multiple runways where terrain or operational constraints do not allow for the standard T. The “T” may be modified by increasing or decreasing the angle from the corner IAF(s) to the IF or by eliminating one or both corner IAFs.

c. STANDARD I– An RNAV approach design for a single runway with both corner IAFs eliminated. Course reversal or radar vectoring may be required at busy terminals with multiple runways.

d. TERMINAL ARRIVAL AREA (TAA)– The TAA is controlled airspace established in conjunction with the Standard or Modified T and I RNAV approach configurations. In the standard TAA, there are three areas: straight-in, left base, and right base. The arc boundaries of the three areas of the TAA are published portions of the approach and allow aircraft to transition from the en route structure direct to the nearest IAF. TAAs will also eliminate or reduce feeder routes, departure extensions, and procedure turns or course reversal.

1. STRAIGHT-IN AREA– A 30NM arc centered on the IF bounded by a straight line extending through the IF perpendicular to the intermediate course.

2. LEFT BASE AREA– A 30NM arc centered on the right corner IAF. The area shares a boundary with the straight-in area except that it extends out for 30NM from the IAF and is bounded on the other side by a line extending from the IF through the FAF to the arc.

3. RIGHT BASE AREA– A 30NM arc centered on the left corner IAF. The area shares a boundary with the straight-in area except that it extends out for 30NM from the IAF and is bounded on the other side by a line extending from the IF through the FAF to the arc.

AREA NAVIGATION (RNAV) GLOBAL POSITIONING SYSTEM (GPS) PRECISION RUNWAY MONITORING (PRM) APPROACH

A GPS approach, which requires vertical guidance, used in lieu of an ILS PRM approach to conduct approaches to parallel runways whose extended centerlines are separated by less than 4,300 feet and at least 3,000 feet, where simultaneous close parallel approaches are permitted. Also used in lieu of an ILS PRM and/or LDA PRM approach to conduct Simultaneous Offset Instrument Approach (SOIA) operations.

ARINC– An acronym for Aeronautical Radio, Inc., a corporation largely owned by a group of airlines. ARINC is licensed by the FCC as an aeronautical station and contracted by the FAA to provide communications support for air traffic control and meteorological services in portions of international airspace.

ARMY AVIATION FLIGHT INFORMATION BULLETIN– A bulletin that provides air operation data covering Army, National Guard, and Army Reserve aviation activities.

ARO–

(See AIRPORT RESERVATION OFFICE.)

ARRESTING SYSTEM– A safety device consisting of two major components, namely, engaging or catching devices and energy absorption devices for the purpose of arresting both tailhook and/or nontailhook-equipped aircraft. It is used to prevent aircraft from overrunning runways when the aircraft cannot be stopped after landing or during aborted takeoff. Arresting systems have various names; e.g., arresting gear, hook device, wire barrier cable.

(See ABORT.)

(Refer to AIM.)

ARRIVAL AIRCRAFT INTERVAL– An internally generated program in hundredths of minutes based upon the AAR. AAI is the desired optimum interval between successive arrival aircraft over the vertex.

ARRIVAL CENTER– The ARTCC having jurisdiction for the impacted airport.

ARRIVAL DELAY– A parameter which specifies a period of time in which no aircraft will be metered for arrival at the specified airport.

ARRIVAL SECTOR– An operational control sector containing one or more meter fixes.

ARRIVAL SECTOR ADVISORY LIST– An ordered list of data on arrivals displayed at the

PVD/MDM of the sector which controls the meter fix.

ARRIVAL SEQUENCING PROGRAM– The automated program designed to assist in sequencing aircraft destined for the same airport.

ARRIVAL TIME– The time an aircraft touches down on arrival.

ARSR–
(See AIR ROUTE SURVEILLANCE RADAR.)

ARTCC–
(See AIR ROUTE TRAFFIC CONTROL CENTER.)

ARTS–
(See AUTOMATED RADAR TERMINAL SYSTEMS.)

ASDA–
(See ACCELERATE-STOP DISTANCE AVAILABLE.)

ASDA [ICAO]–
(See ICAO Term ACCELERATE-STOP DISTANCE AVAILABLE.)

ASDE–
(See AIRPORT SURFACE DETECTION EQUIPMENT.)

ASF–
(See AIRPORT STREAM FILTER.)

ASLAR–
(See AIRCRAFT SURGE LAUNCH AND RECOVERY.)

ASP–
(See ARRIVAL SEQUENCING PROGRAM.)

ASR–
(See AIRPORT SURVEILLANCE RADAR.)

ASR APPROACH–
(See SURVEILLANCE APPROACH.)

ASSOCIATED– A radar target displaying a data block with flight identification and altitude information.

(See UNASSOCIATED.)

ATC–
(See AIR TRAFFIC CONTROL.)

ATC ADVISES– Used to prefix a message of noncontrol information when it is relayed to an aircraft by other than an air traffic controller.

(See ADVISORY.)

ATC ASSIGNED AIRSPACE– Airspace of defined vertical/lateral limits, assigned by ATC, for the purpose of providing air traffic segregation between the specified activities being conducted within the assigned airspace and other IFR air traffic.

(See SPECIAL USE AIRSPACE.)

ATC CLEARANCE–
(See AIR TRAFFIC CLEARANCE.)

ATC CLEARS– Used to prefix an ATC clearance when it is relayed to an aircraft by other than an air traffic controller.

ATC INSTRUCTIONS– Directives issued by air traffic control for the purpose of requiring a pilot to take specific actions; e.g., “Turn left heading two five zero,” “Go around,” “Clear the runway.”

(Refer to 14 CFR Part 91.)

ATC PREFERRED ROUTE NOTIFICATION– EDST notification to the appropriate controller of the need to determine if an ATC preferred route needs to be applied, based on destination airport.

(See ROUTE ACTION NOTIFICATION.)

(See EN ROUTE DECISION SUPPORT TOOL.)

ATC PREFERRED ROUTES– Preferred routes that are not automatically applied by Host.

ATC REQUESTS– Used to prefix an ATC request when it is relayed to an aircraft by other than an air traffic controller.

ATC SECURITY SERVICES– Communications and security tracking provided by an ATC facility in support of the DHS, the DOD, or other Federal security elements in the interest of national security. Such security services are only applicable within designated areas. ATC security services do not include ATC basic radar services or flight following.

ATC SECURITY SERVICES POSITION– The position responsible for providing ATC security services as defined. This position does not provide ATC, IFR separation, or VFR flight following services, but is responsible for providing security services in an area comprising airspace assigned to one or more ATC operating sectors. This position may be combined with control positions.

ATC SECURITY TRACKING– The continuous tracking of aircraft movement by an ATC facility in

support of the DHS, the DOD, or other security elements for national security using radar (i.e., radar tracking) or other means (e.g., manual tracking) without providing basic radar services (including traffic advisories) or other ATC services not defined in this section.

ATS SURVEILLANCE SERVICE [ICAO]– A term used to indicate a service provided directly by means of an ATS surveillance system.

ATC SURVEILLANCE SOURCE– Used by ATC for establishing identification, control and separation using a target depicted on an air traffic control facility’s video display that has met the relevant safety standards for operational use and received from one, or a combination, of the following surveillance sources:

- a. Radar (See RADAR.)
- b. ADS-B (See AUTOMATIC DEPENDENT SURVEILLANCE–BROADCAST.)
- c. WAM (See WIDE AREA MULTILATERATION.)
(See INTERROGATOR.)
(See TRANSPONDER.)
(See ICAO term RADAR.)
(Refer to AIM.)

ATS SURVEILLANCE SYSTEM [ICAO]– A generic term meaning variously, ADS–B, PSR, SSR or any comparable ground–based system that enables the identification of aircraft.

Note: A comparable ground–based system is one that has been demonstrated, by comparative assessment or other methodology, to have a level of safety and performance equal to or better than monopulse SSR.

ATCAA–
(See ATC ASSIGNED AIRSPACE.)

ATCRBS–
(See RADAR.)

ATCSCC–
(See AIR TRAFFIC CONTROL SYSTEM COMMAND CENTER.)

ATCT–
(See TOWER.)

ATD–
(See ALONG–TRACK DISTANCE.)

ATIS–
(See AUTOMATIC TERMINAL INFORMATION SERVICE.)

ATIS [ICAO]–
(See ICAO Term AUTOMATIC TERMINAL INFORMATION SERVICE.)

ATS ROUTE [ICAO]– A specified route designed for channeling the flow of traffic as necessary for the provision of air traffic services.

Note: The term “ATS Route” is used to mean variously, airway, advisory route, controlled or uncontrolled route, arrival or departure, etc.

ATTENTION ALL USERS PAGE (AAUP)– The AAUP provides the pilot with additional information relative to conducting a specific operation, for example, PRM approaches and RNAV departures.

AUTOLAND APPROACH–An autoland system aids by providing control of aircraft systems during a precision instrument approach to at least decision altitude and possibly all the way to touchdown, as well as in some cases, through the landing rollout. The autoland system is a sub-system of the autopilot system from which control surface management occurs. The aircraft autopilot sends instructions to the autoland system and monitors the autoland system performance and integrity during its execution.

AUTOMATED INFORMATION TRANSFER (AIT)– A precoordinated process, specifically defined in facility directives, during which a transfer of altitude control and/or radar identification is accomplished without verbal coordination between controllers using information communicated in a full data block.

AUTOMATED MUTUAL-ASSISTANCE VESSEL RESCUE SYSTEM– A facility which can deliver, in a matter of minutes, a surface picture (SURPIC) of vessels in the area of a potential or actual search and rescue incident, including their predicted positions and their characteristics.

(See FAA Order JO 7110.65, Para 10–6–4, INFLIGHT CONTINGENCIES.)

AUTOMATED PROBLEM DETECTION (APD)– An Automation Processing capability that compares trajectories in order to predict conflicts.

AUTOMATED PROBLEM DETECTION BOUNDARY (APB)– The adapted distance beyond a facilities boundary defining the airspace within which EDST performs conflict detection.

(See EN ROUTE DECISION SUPPORT TOOL.)

AUTOMATED PROBLEM DETECTION INHIBITED AREA (APDIA)– Airspace surrounding a

terminal area within which APD is inhibited for all flights within that airspace.

AUTOMATED RADAR TERMINAL SYSTEMS (ARTS)– A generic term for several tracking systems included in the Terminal Automation Systems (TAS). ARTS plus a suffix roman numeral denotes a major modification to that system.

a. ARTS IIIA. The Radar Tracking and Beacon Tracking Level (RT&BTL) of the modular, programmable automated radar terminal system. ARTS IIIA detects, tracks, and predicts primary as well as secondary radar-derived aircraft targets. This more sophisticated computer-driven system upgrades the existing ARTS III system by providing improved tracking, continuous data recording, and fail-soft capabilities.

b. Common ARTS. Includes ARTS IIE, ARTS IIIE; and ARTS IIIE with ACD (see DTAS) which combines functionalities of the previous ARTS systems.

AUTOMATED WEATHER SYSTEM– Any of the automated weather sensor platforms that collect weather data at airports and disseminate the weather information via radio and/or landline. The systems currently consist of the Automated Surface Observing System (ASOS) and Automated Weather Observation System (AWOS).

AUTOMATED UNICOM– Provides completely automated weather, radio check capability and airport advisory information on an Automated UNICOM system. These systems offer a variety of features, typically selectable by microphone clicks, on the UNICOM frequency. Availability will be published in the Chart Supplement U.S. and approach charts.

AUTOMATIC ALTITUDE REPORT–

(See ALTITUDE READOUT.)

AUTOMATIC ALTITUDE REPORTING– That function of a transponder which responds to Mode C interrogations by transmitting the aircraft's altitude in 100-foot increments.

AUTOMATIC CARRIER LANDING SYSTEM– U.S. Navy final approach equipment consisting of precision tracking radar coupled to a computer data link to provide continuous information to the aircraft, monitoring capability to the pilot, and a backup approach system.

AUTOMATIC DEPENDENT SURVEILLANCE (ADS) [ICAO]– A surveillance technique in which aircraft automatically provide, via a data link, data derived from on-board navigation and position fixing systems, including aircraft identification, four dimensional position and additional data as appropriate.

AUTOMATIC DEPENDENT SURVEILLANCE–BROADCAST (ADS-B)– A surveillance system in which an aircraft or vehicle to be detected is fitted with cooperative equipment in the form of a data link transmitter. The aircraft or vehicle periodically broadcasts its GPS-derived position and other information such as velocity over the data link, which is received by a ground-based transmitter/receiver (transceiver) for processing and display at an air traffic control facility.

(See GLOBAL POSITIONING SYSTEM.)

(See GROUND-BASED TRANSCEIVER.)

AUTOMATIC DEPENDENT SURVEILLANCE–CONTRACT (ADS-C)– A data link position reporting system, controlled by a ground station, that establishes contracts with an aircraft's avionics that occur automatically whenever specific events occur, or specific time intervals are reached.

AUTOMATIC DEPENDENT SURVEILLANCE–REBROADCAST (ADS-R)– A datalink translation function of the ADS-B ground system required to accommodate the two separate operating frequencies (978 MHz and 1090 MHz). The ADS-B system receives the ADS-B messages transmitted on one frequency and ADS-R translates and reformats the information for rebroadcast and use on the other frequency. This allows ADS-B In equipped aircraft to see nearby ADS-B Out traffic regardless of the operating link of the other aircraft. Aircraft operating on the same ADS-B frequency exchange information directly and do not require the ADS-R translation function.

AUTOMATIC DIRECTION FINDER– An aircraft radio navigation system which senses and indicates the direction to a L/MF nondirectional radio beacon (NDB) ground transmitter. Direction is indicated to the pilot as a magnetic bearing or as a relative bearing to the longitudinal axis of the aircraft depending on the type of indicator installed in the aircraft. In certain applications, such as military, ADF operations may

be based on airborne and ground transmitters in the VHF/UHF frequency spectrum.

(See BEARING.)

(See NONDIRECTIONAL BEACON.)

AUTOMATIC FLIGHT INFORMATION SERVICE (AFIS) – ALASKA FSSs ONLY– The continuous broadcast of recorded non-control information at airports in Alaska where a FSS provides local airport advisory service. The AFIS broadcast automates the repetitive transmission of essential but routine information such as weather, wind, altimeter, favored runway, braking action, airport NOTAMs, and other applicable information. The information is continuously broadcast over a discrete VHF radio frequency (usually the ASOS/ AWOS frequency).

AUTOMATIC TERMINAL INFORMATION SERVICE– The continuous broadcast of recorded noncontrol information in selected terminal areas. Its purpose is to improve controller effectiveness and to relieve frequency congestion by automating the repetitive transmission of essential but routine information; e.g., “Los Angeles information Alfa. One three zero zero Coordinated Universal Time. Weather, measured ceiling two thousand overcast, visibility three, haze, smoke, temperature seven one, dew point five seven, wind two five zero at five, altimeter two niner niner six. I-L-S Runway Two Five Left approach in use, Runway Two Five Right closed, advise you have Alfa.”

(See ICAO term AUTOMATIC TERMINAL INFORMATION SERVICE.)

(Refer to AIM.)

AUTOMATIC TERMINAL INFORMATION SERVICE [ICAO]– The provision of current, routine information to arriving and departing aircraft by

means of continuous and repetitive broadcasts throughout the day or a specified portion of the day.

AUTOROTATION– A rotorcraft flight condition in which the lifting rotor is driven entirely by action of the air when the rotorcraft is in motion.

a. Autorotative Landing/Touchdown Autorotation. Used by a pilot to indicate that the landing will be made without applying power to the rotor.

b. Low Level Autorotation. Commences at an altitude well below the traffic pattern, usually below 100 feet AGL and is used primarily for tactical military training.

c. 180 degrees Autorotation. Initiated from a downwind heading and is commenced well inside the normal traffic pattern. “Go around” may not be possible during the latter part of this maneuver.

AVAILABLE LANDING DISTANCE (ALD)– The portion of a runway available for landing and roll-out for aircraft cleared for LAHSO. This distance is measured from the landing threshold to the hold-short point.

AVIATION WEATHER SERVICE– A service provided by the National Weather Service (NWS) and FAA which collects and disseminates pertinent weather information for pilots, aircraft operators, and ATC. Available aviation weather reports and forecasts are displayed at each NWS office and FAA FSS.

(See TRANSCRIBED WEATHER BROADCAST.)

(See WEATHER ADVISORY.)

(Refer to AIM.)

AWW–

(See SEVERE WEATHER FORECAST ALERTS.)

B

BACK-TAXI– A term used by air traffic controllers to taxi an aircraft on the runway opposite to the traffic flow. The aircraft may be instructed to back-taxi to the beginning of the runway or at some point before reaching the runway end for the purpose of departure or to exit the runway.

BASE LEG–

(See TRAFFIC PATTERN.)

BEACON–

(See AERONAUTICAL BEACON.)

(See AIRPORT ROTATING BEACON.)

(See AIRWAY BEACON.)

(See MARKER BEACON.)

(See NONDIRECTIONAL BEACON.)

(See RADAR.)

BEARING– The horizontal direction to or from any point, usually measured clockwise from true north, magnetic north, or some other reference point through 360 degrees.

(See NONDIRECTIONAL BEACON.)

BELOW MINIMUMS– Weather conditions below the minimums prescribed by regulation for the particular action involved; e.g., landing minimums, takeoff minimums.

BLAST FENCE– A barrier that is used to divert or dissipate jet or propeller blast.

BLAST PAD– A surface adjacent to the ends of a runway provided to reduce the erosive effect of jet blast and propeller wash.

BLIND SPEED– The rate of departure or closing of a target relative to the radar antenna at which cancellation of the primary radar target by moving target indicator (MTI) circuits in the radar equipment causes a reduction or complete loss of signal.

(See ICAO term BLIND VELOCITY.)

BLIND SPOT– An area from which radio transmissions and/or radar echoes cannot be received. The term is also used to describe portions of the airport not visible from the control tower.

BLIND TRANSMISSION–

(See TRANSMITTING IN THE BLIND.)

BLIND VELOCITY [ICAO]– The radial velocity of a moving target such that the target is not seen on primary radars fitted with certain forms of fixed echo suppression.

BLIND ZONE–

(See BLIND SPOT.)

BLOCKED– Phraseology used to indicate that a radio transmission has been distorted or interrupted due to multiple simultaneous radio transmissions.

BOTTOM ALTITUDE– In reference to published altitude restrictions on a STAR or STAR runway transition, the lowest altitude authorized.

BOUNDARY LIGHTS–

(See AIRPORT LIGHTING.)

BRAKING ACTION (GOOD, GOOD TO MEDIUM, MEDIUM, MEDIUM TO POOR, POOR, OR NIL)– A report of conditions on the airport movement area providing a pilot with a degree/quality of braking to expect. Braking action is reported in terms of good, good to medium, medium, medium to poor, poor, or nil.

(See RUNWAY CONDITION READING.)

(See RUNWAY CONDITION REPORT.)

(See RUNWAY CONDITION CODES.)

BRAKING ACTION ADVISORIES– When tower controllers receive runway braking action reports which include the terms “medium,” “poor,” or “nil,” or whenever weather conditions are conducive to deteriorating or rapidly changing runway braking conditions, the tower will include on the ATIS broadcast the statement, “Braking Action Advisories are in Effect.” During the time braking action advisories are in effect, ATC will issue the most current braking action report for the runway in use to each arriving and departing aircraft. Pilots should be prepared for deteriorating braking conditions and should request current runway condition information if not issued by controllers. Pilots should also be prepared to provide a descriptive runway condition report to controllers after landing.

BREAKOUT– A technique to direct aircraft out of the approach stream. In the context of simultaneous (independent) parallel operations, a breakout is used to direct threatened aircraft away from a deviating aircraft.

BROADCAST– Transmission of information for which an acknowledgement is not expected.

(See ICAO term BROADCAST.)

BROADCAST [ICAO]– A transmission of information relating to air navigation that is not addressed to a specific station or stations.

BUFFER AREA– As applied to an MVA or MIA chart, a depicted three (3) or five (5) NM radius MVA/MIA sector isolating a displayed obstacle for which the sector is established. A portion of a buffer area can also be inclusive of a MVA/MIA sector polygon boundary.

C

CALCULATED LANDING TIME– A term that may be used in place of tentative or actual calculated landing time, whichever applies.

CALL FOR RELEASE– Wherein the overlying ARTCC requires a terminal facility to initiate verbal coordination to secure ARTCC approval for release of a departure into the en route environment.

CALL UP– Initial voice contact between a facility and an aircraft, using the identification of the unit being called and the unit initiating the call.

(Refer to AIM.)

CANADIAN MINIMUM NAVIGATION PERFORMANCE SPECIFICATION AIRSPACE– That portion of Canadian domestic airspace within which MNPS separation may be applied.

CARDINAL ALTITUDES– “Odd” or “Even” thousand-foot altitudes or flight levels; e.g., 5,000, 6,000, 7,000, FL 250, FL 260, FL 270.

(See ALTITUDE.)

(See FLIGHT LEVEL.)

CARDINAL FLIGHT LEVELS–

(See CARDINAL ALTITUDES.)

CAT–

(See CLEAR-AIR TURBULENCE.)

CATCH POINT– A fix/waypoint that serves as a transition point from the high altitude waypoint navigation structure to an arrival procedure (STAR) or the low altitude ground-based navigation structure.

CEILING– The heights above the earth’s surface of the lowest layer of clouds or obscuring phenomena that is reported as “broken,” “overcast,” or “obscuration,” and not classified as “thin” or “partial.”

(See ICAO term CEILING.)

CEILING [ICAO]– The height above the ground or water of the base of the lowest layer of cloud below 6,000 meters (20,000 feet) covering more than half the sky.

CENRAP–

(See CENTER RADAR ARTS PRESENTATION/PROCESSING.)

CENRAP-PLUS–

(See CENTER RADAR ARTS PRESENTATION/PROCESSING-PLUS.)

CENTER–

(See AIR ROUTE TRAFFIC CONTROL CENTER.)

CENTER’S AREA– The specified airspace within which an air route traffic control center (ARTCC) provides air traffic control and advisory service.

(See AIR ROUTE TRAFFIC CONTROL CENTER.)

(Refer to AIM.)

CENTER RADAR ARTS PRESENTATION/PROCESSING– A computer program developed to provide a back-up system for airport surveillance radar in the event of a failure or malfunction. The program uses air route traffic control center radar for the processing and presentation of data on the ARTS IIA or IIIA displays.

CENTER RADAR ARTS PRESENTATION/PROCESSING-PLUS– A computer program developed to provide a back-up system for airport surveillance radar in the event of a terminal secondary radar system failure. The program uses a combination of Air Route Traffic Control Center Radar and terminal airport surveillance radar primary targets displayed simultaneously for the processing and presentation of data on the ARTS IIA or IIIA displays.

CENTER TRACON AUTOMATION SYSTEM (CTAS)– A computerized set of programs designed to aid Air Route Traffic Control Centers and TRACONS in the management and control of air traffic.

CENTER WEATHER ADVISORY– An unscheduled weather advisory issued by Center Weather Service Unit meteorologists for ATC use to alert pilots of existing or anticipated adverse weather conditions within the next 2 hours. A CWA may modify or redefine a SIGMET.

(See AWW.)

(See AIRMET.)

(See CONVECTIVE SIGMET.)

(See SIGMET.)

(Refer to AIM.)

CENTRAL EAST PACIFIC– An organized route system between the U.S. West Coast and Hawaii.

CEP–

(See **CENTRAL EAST PACIFIC**.)

CERAP–

(See **COMBINED CENTER-RAPCON**.)

CERTIFIED TOWER RADAR DISPLAY (CTRD)– An FAA radar display certified for use in the NAS.

CFR–

(See **CALL FOR RELEASE**.)

CHAFF– Thin, narrow metallic reflectors of various lengths and frequency responses, used to reflect radar energy. These reflectors, when dropped from aircraft and allowed to drift downward, result in large targets on the radar display.

CHART SUPPLEMENT U.S.– A publication designed primarily as a pilot's operational manual containing all airports, seaplane bases, and heliports open to the public including communications data, navigational facilities, and certain special notices and procedures. This publication is issued in seven volumes according to geographical area.

CHARTED VFR FLYWAYS– Charted VFR Flyways are flight paths recommended for use to bypass areas heavily traversed by large turbine-powered aircraft. Pilot compliance with recommended flyways and associated altitudes is strictly voluntary. VFR Flyway Planning charts are published on the back of existing VFR Terminal Area charts.

CHARTED VISUAL FLIGHT PROCEDURE APPROACH– An approach conducted while operating on an instrument flight rules (IFR) flight plan which authorizes the pilot of an aircraft to proceed visually and clear of clouds to the airport via visual landmarks and other information depicted on a charted visual flight procedure. This approach must be authorized and under the control of the appropriate air traffic control facility. Weather minimums required are depicted on the chart.

CHASE– An aircraft flown in proximity to another aircraft normally to observe its performance during training or testing.

CHASE AIRCRAFT–

(See **CHASE**.)

CHOP– A form of turbulence.

a. Light Chop– Turbulence that causes slight, rapid and somewhat rhythmic bumpiness without appreciable changes in altitude or attitude.

b. Moderate Chop– Turbulence similar to Light Chop but of greater intensity. It causes rapid bumps or jolts without appreciable changes in aircraft altitude or attitude.

(See **TURBULENCE**.)

CIRCLE-TO-LAND MANEUVER– A maneuver initiated by the pilot to align the aircraft with a runway for landing when a straight-in landing from an instrument approach is not possible or is not desirable. At tower controlled airports, this maneuver is made only after ATC authorization has been obtained and the pilot has established required visual reference to the airport.

(See **CIRCLE TO RUNWAY**.)

(See **LANDING MINIMUMS**.)

(Refer to **AIM**.)

CIRCLE TO RUNWAY (RUNWAY NUMBER)– Used by ATC to inform the pilot that he/she must circle to land because the runway in use is other than the runway aligned with the instrument approach procedure. When the direction of the circling maneuver in relation to the airport/runway is required, the controller will state the direction (eight cardinal compass points) and specify a left or right downwind or base leg as appropriate; e.g., “Cleared VOR Runway Three Six Approach circle to Runway Two Two,” or “Circle northwest of the airport for a right downwind to Runway Two Two.”

(See **CIRCLE-TO-LAND MANEUVER**.)

(See **LANDING MINIMUMS**.)

(Refer to **AIM**.)

CIRCLING APPROACH–

(See **CIRCLE-TO-LAND MANEUVER**.)

CIRCLING MANEUVER–

(See **CIRCLE-TO-LAND MANEUVER**.)

CIRCLING MINIMA–

(See **LANDING MINIMUMS**.)

CLASS A AIRSPACE–

(See **CONTROLLED AIRSPACE**.)

CLASS B AIRSPACE–

(See **CONTROLLED AIRSPACE**.)

CLASS C AIRSPACE–

(See **CONTROLLED AIRSPACE**.)

CLASS D AIRSPACE–

(See CONTROLLED AIRSPACE.)

CLASS E AIRSPACE–

(See CONTROLLED AIRSPACE.)

CLASS G AIRSPACE– Airspace that is not designated in 14 CFR Part 71 as Class A, Class B, Class C, Class D, or Class E controlled airspace is Class G (uncontrolled) airspace.

(See UNCONTROLLED AIRSPACE.)

CLEAR AIR TURBULENCE (CAT)– Turbulence encountered in air where no clouds are present. This term is commonly applied to high-level turbulence associated with wind shear. CAT is often encountered in the vicinity of the jet stream.

(See WIND SHEAR.)

(See JET STREAM.)

CLEAR OF THE RUNWAY–

a. Taxiing aircraft, which is approaching a runway, is clear of the runway when all parts of the aircraft are held short of the applicable runway holding position marking.

b. A pilot or controller may consider an aircraft, which is exiting or crossing a runway, to be clear of the runway when all parts of the aircraft are beyond the runway edge and there are no restrictions to its continued movement beyond the applicable runway holding position marking.

c. Pilots and controllers shall exercise good judgement to ensure that adequate separation exists between all aircraft on runways and taxiways at airports with inadequate runway edge lines or holding position markings.

CLEARANCE–

(See AIR TRAFFIC CLEARANCE.)

CLEARANCE LIMIT– The fix, point, or location to which an aircraft is cleared when issued an air traffic clearance.

(See ICAO term CLEARANCE LIMIT.)

CLEARANCE LIMIT [ICAO]– The point to which an aircraft is granted an air traffic control clearance.

CLEARANCE VOID IF NOT OFF BY (TIME)–

Used by ATC to advise an aircraft that the departure clearance is automatically canceled if takeoff is not made prior to a specified time. The pilot must obtain

a new clearance or cancel his/her IFR flight plan if not off by the specified time.

(See ICAO term CLEARANCE VOID TIME.)

CLEARANCE VOID TIME [ICAO]– A time specified by an air traffic control unit at which a clearance ceases to be valid unless the aircraft concerned has already taken action to comply therewith.

CLEARED APPROACH– ATC authorization for an aircraft to execute any standard or special instrument approach procedure for that airport. Normally, an aircraft will be cleared for a specific instrument approach procedure.

(See CLEARED (Type of) APPROACH.)

(See INSTRUMENT APPROACH PROCEDURE.)

(Refer to 14 CFR Part 91.)

(Refer to AIM.)

CLEARED (Type of) APPROACH– ATC authorization for an aircraft to execute a specific instrument approach procedure to an airport; e.g., “Cleared ILS Runway Three Six Approach.”

(See APPROACH CLEARANCE.)

(See INSTRUMENT APPROACH PROCEDURE.)

(Refer to 14 CFR Part 91.)

(Refer to AIM.)

CLEARED AS FILED– Means the aircraft is cleared to proceed in accordance with the route of flight filed in the flight plan. This clearance does not include the altitude, DP, or DP Transition.

(See REQUEST FULL ROUTE CLEARANCE.)

(Refer to AIM.)

CLEARED FOR TAKEOFF– ATC authorization for an aircraft to depart. It is predicated on known traffic and known physical airport conditions.

CLEARED FOR THE OPTION– ATC authorization for an aircraft to make a touch-and-go, low approach, missed approach, stop and go, or full stop landing at the discretion of the pilot. It is normally used in training so that an instructor can evaluate a student’s performance under changing situations. Pilots should advise ATC if they decide to remain on the runway, of any delay in their stop and go, delay clearing the runway, or are unable to comply with the instruction(s).

(See OPTION APPROACH.)

(Refer to AIM.)

CLEARED THROUGH– ATC authorization for an aircraft to make intermediate stops at specified airports without refiling a flight plan while en route to the clearance limit.

CLEARED TO LAND– ATC authorization for an aircraft to land. It is predicated on known traffic and known physical airport conditions.

CLEARWAY– An area beyond the takeoff runway under the control of airport authorities within which terrain or fixed obstacles may not extend above specified limits. These areas may be required for certain turbine-powered operations and the size and upward slope of the clearway will differ depending on when the aircraft was certificated.

(Refer to 14 CFR Part 1.)

CLIMB TO VFR– ATC authorization for an aircraft to climb to VFR conditions within Class B, C, D, and E surface areas when the only weather limitation is restricted visibility. The aircraft must remain clear of clouds while climbing to VFR.

(See SPECIAL VFR CONDITIONS.)

(Refer to AIM.)

CLIMBOUT– That portion of flight operation between takeoff and the initial cruising altitude.

CLIMB VIA– An abbreviated ATC clearance that requires compliance with the procedure lateral path, associated speed restrictions, and altitude restrictions along the cleared route or procedure.

CLOSE PARALLEL RUNWAYS– Two parallel runways whose extended centerlines are separated by less than 4,300 feet and at least 3000 feet (750 feet for SOIA operations) for which ATC is authorized to conduct simultaneous independent approach operations. PRM and simultaneous close parallel appear in approach title. Dual communications, special pilot training, an Attention All Users Page (AAUP), NTZ monitoring by displays that have aural and visual alerting algorithms are required. A high update rate surveillance sensor is required for certain runway or approach course spacing.

CLOSED RUNWAY– A runway that is unusable for aircraft operations. Only the airport management/military operations office can close a runway.

CLOSED TRAFFIC– Successive operations involving takeoffs and landings or low approaches where the aircraft does not exit the traffic pattern.

CLOUD– A cloud is a visible accumulation of minute water droplets and/or ice particles in the atmosphere above the Earth's surface. Cloud differs from ground fog, fog, or ice fog only in that the latter are, by definition, in contact with the Earth's surface.

CLT–

(See CALCULATED LANDING TIME.)

CLUTTER– In radar operations, clutter refers to the reception and visual display of radar returns caused by precipitation, chaff, terrain, numerous aircraft targets, or other phenomena. Such returns may limit or preclude ATC from providing services based on radar.

(See CHAFF.)

(See GROUND CLUTTER.)

(See PRECIPITATION.)

(See TARGET.)

(See ICAO term RADAR CLUTTER.)

CMNPS–

(See CANADIAN MINIMUM NAVIGATION PERFORMANCE SPECIFICATION AIRSPACE.)

COASTAL FIX– A navigation aid or intersection where an aircraft transitions between the domestic route structure and the oceanic route structure.

CODES– The number assigned to a particular multiple pulse reply signal transmitted by a transponder.

(See DISCRETE CODE.)

COLD TEMPERATURE COMPENSATION– An action on the part of the pilot to adjust an aircraft's indicated altitude due to the effect of cold temperatures on true altitude above terrain versus aircraft indicated altitude. The amount of compensation required increases at a greater rate with a decrease in temperature and increase in height above the reporting station.

COLLABORATIVE TRAJECTORY OPTIONS PROGRAM (CTOP)– CTOP is a traffic management program administered by the Air Traffic Control System Command Center (ATCSCC) that manages demand through constrained airspace, while considering operator preference with regard to both route and delay as defined in a Trajectory Options Set (TOS).

COMBINED CENTER-RAPCON– An air traffic facility which combines the functions of an ARTCC and a radar approach control facility.

(See AIR ROUTE TRAFFIC CONTROL CENTER.)

(See RADAR APPROACH CONTROL FACILITY.)

COMMON POINT– A significant point over which two or more aircraft will report passing or have reported passing before proceeding on the same or diverging tracks. To establish/maintain longitudinal separation, a controller may determine a common point not originally in the aircraft's flight plan and then clear the aircraft to fly over the point.

(See SIGNIFICANT POINT.)

COMMON PORTION–

(See COMMON ROUTE.)

COMMON ROUTE– That segment of a North American Route between the inland navigation facility and the coastal fix.

OR

COMMON ROUTE– Typically the portion of a RNAV STAR between the en route transition end point and the runway transition start point; however, the common route may only consist of a single point that joins the en route and runway transitions.

COMMON TRAFFIC ADVISORY FREQUENCY (CTAF)– A frequency designed for the purpose of carrying out airport advisory practices while operating to or from an airport without an operating control tower. The CTAF may be a UNICOM, Multicom, FSS, or tower frequency and is identified in appropriate aeronautical publications.

(See DESIGNATED COMMON TRAFFIC ADVISORY FREQUENCY (CTAF) AREA.)

(Refer to AC 90-42, Traffic Advisory Practices at Airports Without Operating Control Towers.)

COMPASS LOCATOR– A low power, low or medium frequency (L/MF) radio beacon installed at the site of the outer or middle marker of an instrument landing system (ILS). It can be used for navigation at distances of approximately 15 miles or as authorized in the approach procedure.

a. Outer Compass Locator (LOM)– A compass locator installed at the site of the outer marker of an instrument landing system.

(See OUTER MARKER.)

b. Middle Compass Locator (LMM)– A compass locator installed at the site of the middle marker of an instrument landing system.

(See MIDDLE MARKER.)

(See ICAO term LOCATOR.)

COMPASS ROSE– A circle, graduated in degrees, printed on some charts or marked on the ground at an airport. It is used as a reference to either true or magnetic direction.

COMPLY WITH RESTRICTIONS– An ATC instruction that requires an aircraft being vectored back onto an arrival or departure procedure to comply with all altitude and/or speed restrictions depicted on the procedure. This term may be used in lieu of repeating each remaining restriction that appears on the procedure.

COMPOSITE FLIGHT PLAN– A flight plan which specifies VFR operation for one portion of flight and IFR for another portion. It is used primarily in military operations.

(Refer to AIM.)

COMPULSORY REPORTING POINTS– Reporting points which must be reported to ATC. They are designated on aeronautical charts by solid triangles or filed in a flight plan as fixes selected to define direct routes. These points are geographical locations which are defined by navigation aids/fixes. Pilots should discontinue position reporting over compulsory reporting points when informed by ATC that their aircraft is in “radar contact.”

COMPUTER NAVIGATION FIX (CNF)– A Computer Navigation Fix is a point defined by a latitude/longitude coordinate and is required to support Performance-Based Navigation (PBN) operations. A five-letter identifier denoting a CNF can be found next to an “x” on en route charts and on some approach charts. Eventually, all CNFs will be labeled and begin with the letters “CF” followed by three consonants (e.g., ‘CFWBG’). CNFs are not recognized by ATC, are not contained in ATC fix or automation databases, and are not used for ATC purposes. Pilots should not use CNFs for point-to-point navigation (e.g., proceed direct), filing a flight plan, or in aircraft/ATC communications. Use of CNFs has not been adopted or recognized by the International Civil Aviation Organization (ICAO).

(REFER to AIM 1-1-17b5(i)(2), Global Positioning System (GPS).)

CONDITIONS NOT MONITORED– When an airport operator cannot monitor the condition of the movement area or airfield surface area, this information is issued as a NOTAM. Usually necessitated due to staffing, operating hours or other mitigating factors associated with airport operations.

CONFIDENCE MANEUVER– A confidence maneuver consists of one or more turns, a climb or descent, or other maneuver to determine if the pilot in command (PIC) is able to receive and comply with ATC instructions.

CONFLICT ALERT– A function of certain air traffic control automated systems designed to alert radar controllers to existing or pending situations between tracked targets (known IFR or VFR aircraft) that require his/her immediate attention/action.

(See **MODE C INTRUDER ALERT**.)

CONFLICT RESOLUTION– The resolution of potential conflicts between aircraft that are radar identified and in communication with ATC by ensuring that radar targets do not touch. Pertinent traffic advisories shall be issued when this procedure is applied.

Note: This procedure shall not be provided utilizing mosaic radar systems.

CONFORMANCE– The condition established when an aircraft’s actual position is within the conformance region constructed around that aircraft at its position, according to the trajectory associated with the aircraft’s Current Plan.

CONFORMANCE REGION– A volume, bounded laterally, vertically, and longitudinally, within which an aircraft must be at a given time in order to be in conformance with the Current Plan Trajectory for that aircraft. At a given time, the conformance region is determined by the simultaneous application of the lateral, vertical, and longitudinal conformance bounds for the aircraft at the position defined by time and aircraft’s trajectory.

CONSOLAN– A low frequency, long-distance NAVAID used principally for transoceanic navigations.

CONTACT–

a. Establish communication with (followed by the name of the facility and, if appropriate, the frequency to be used).

b. A flight condition wherein the pilot ascertains the attitude of his/her aircraft and navigates by visual reference to the surface.

(See **CONTACT APPROACH**.)

(See **RADAR CONTACT**.)

CONTACT APPROACH– An approach wherein an aircraft on an IFR flight plan, having an air traffic control authorization, operating clear of clouds with at least 1 mile flight visibility and a reasonable expectation of continuing to the destination airport in those conditions, may deviate from the instrument approach procedure and proceed to the destination airport by visual reference to the surface. This approach will only be authorized when requested by the pilot and the reported ground visibility at the destination airport is at least 1 statute mile.

(Refer to **AIM**.)

CONTAMINATED RUNWAY– A runway is considered contaminated whenever standing water, ice, snow, slush, frost in any form, heavy rubber, or other substances are present. A runway is contaminated with respect to rubber deposits or other friction-degrading substances when the average friction value for any 500-foot segment of the runway within the ALD fails below the recommended minimum friction level and the average friction value in the adjacent 500-foot segments falls below the maintenance planning friction level.

CONTERMINOUS U.S.– The 48 adjoining States and the District of Columbia.

CONTINENTAL UNITED STATES– The 49 States located on the continent of North America and the District of Columbia.

CONTINUE– When used as a control instruction should be followed by another word or words clarifying what is expected of the pilot. Example: “continue taxi,” “continue descent,” “continue inbound,” etc.

CONTROL AREA [ICAO]– A controlled airspace extending upwards from a specified limit above the earth.

CONTROL SECTOR– An airspace area of defined horizontal and vertical dimensions for which a controller or group of controllers has air traffic control responsibility, normally within an air route traffic control center or an approach control facility. Sectors are established based on predominant traffic flows, altitude strata, and controller workload. Pilot

communications during operations within a sector are normally maintained on discrete frequencies assigned to the sector.

(See DISCRETE FREQUENCY.)

CONTROL SLASH– A radar beacon slash representing the actual position of the associated aircraft. Normally, the control slash is the one closest to the interrogating radar beacon site. When ARTCC radar is operating in narrowband (digitized) mode, the control slash is converted to a target symbol.

CONTROLLED AIRSPACE– An airspace of defined dimensions within which air traffic control service is provided to IFR flights and to VFR flights in accordance with the airspace classification.

a. Controlled airspace is a generic term that covers Class A, Class B, Class C, Class D, and Class E airspace.

b. Controlled airspace is also that airspace within which all aircraft operators are subject to certain pilot qualifications, operating rules, and equipment requirements in 14 CFR Part 91 (for specific operating requirements, please refer to 14 CFR Part 91). For IFR operations in any class of controlled airspace, a pilot must file an IFR flight plan and receive an appropriate ATC clearance. Each Class B, Class C, and Class D airspace area designated for an airport contains at least one primary airport around which the airspace is designated (for specific designations and descriptions of the airspace classes, please refer to 14 CFR Part 71).

c. Controlled airspace in the United States is designated as follows:

1. CLASS A– Generally, that airspace from 18,000 feet MSL up to and including FL 600, including the airspace overlying the waters within 12 nautical miles of the coast of the 48 contiguous States and Alaska. Unless otherwise authorized, all persons must operate their aircraft under IFR.

2. CLASS B– Generally, that airspace from the surface to 10,000 feet MSL surrounding the nation’s busiest airports in terms of airport operations or passenger enplanements. The configuration of each Class B airspace area is individually tailored and consists of a surface area and two or more layers (some Class B airspace areas resemble upside-down wedding cakes), and is designed to contain all published instrument procedures once an aircraft enters the airspace. An ATC clearance is required for all aircraft to operate in the area, and all aircraft that

are so cleared receive separation services within the airspace. The cloud clearance requirement for VFR operations is “clear of clouds.”

3. CLASS C– Generally, that airspace from the surface to 4,000 feet above the airport elevation (charted in MSL) surrounding those airports that have an operational control tower, are serviced by a radar approach control, and that have a certain number of IFR operations or passenger enplanements. Although the configuration of each Class C area is individually tailored, the airspace usually consists of a surface area with a 5 nautical mile (NM) radius, a circle with a 10NM radius that extends no lower than 1,200 feet up to 4,000 feet above the airport elevation, and an outer area that is not charted. Each person must establish two-way radio communications with the ATC facility providing air traffic services prior to entering the airspace and thereafter maintain those communications while within the airspace. VFR aircraft are only separated from IFR aircraft within the airspace.

(See OUTER AREA.)

4. CLASS D– Generally, that airspace from the surface to 2,500 feet above the airport elevation (charted in MSL) surrounding those airports that have an operational control tower. The configuration of each Class D airspace area is individually tailored and when instrument procedures are published, the airspace will normally be designed to contain the procedures. Arrival extensions for instrument approach procedures may be Class D or Class E airspace. Unless otherwise authorized, each person must establish two-way radio communications with the ATC facility providing air traffic services prior to entering the airspace and thereafter maintain those communications while in the airspace. No separation services are provided to VFR aircraft.

5. CLASS E– Generally, if the airspace is not Class A, Class B, Class C, or Class D, and it is controlled airspace, it is Class E airspace. Class E airspace extends upward from either the surface or a designated altitude to the overlying or adjacent controlled airspace. When designated as a surface area, the airspace will be configured to contain all instrument procedures. Also in this class are Federal airways, airspace beginning at either 700 or 1,200 feet AGL used to transition to/from the terminal or en route environment, en route domestic, and offshore airspace areas designated below 18,000 feet MSL. Unless designated at a lower altitude, Class E

airspace begins at 14,500 MSL over the United States, including that airspace overlying the waters within 12 nautical miles of the coast of the 48 contiguous States and Alaska, up to, but not including 18,000 feet MSL, and the airspace above FL 600.

CONTROLLED AIRSPACE [ICAO]– An airspace of defined dimensions within which air traffic control service is provided to IFR flights and to VFR flights in accordance with the airspace classification.

Note: Controlled airspace is a generic term which covers ATS airspace Classes A, B, C, D, and E.

CONTROLLED TIME OF ARRIVAL– Arrival time assigned during a Traffic Management Program. This time may be modified due to adjustments or user options.

CONTROLLER–

(See AIR TRAFFIC CONTROL SPECIALIST.)

CONTROLLER [ICAO]– A person authorized to provide air traffic control services.

CONTROLLER PILOT DATA LINK COMMUNICATIONS (CPDLC)– A two-way digital communications system that conveys textual air traffic control messages between controllers and pilots using ground or satellite-based radio relay stations.

CONVECTIVE SIGMET– A weather advisory concerning convective weather significant to the safety of all aircraft. Convective SIGMETs are issued for tornadoes, lines of thunderstorms, embedded thunderstorms of any intensity level, areas of thunderstorms greater than or equal to VIP level 4 with an area coverage of $\frac{4}{10}$ (40%) or more, and hail $\frac{3}{4}$ inch or greater.

(See AIRMET.)

(See AWW.)

(See CWA.)

(See SIGMET.)

(Refer to AIM.)

CONVECTIVE SIGNIFICANT METEOROLOGICAL INFORMATION–

(See CONVECTIVE SIGMET.)

COORDINATES– The intersection of lines of reference, usually expressed in degrees/minutes/seconds of latitude and longitude, used to determine position or location.

COORDINATION FIX– The fix in relation to which facilities will handoff, transfer control of an aircraft, or coordinate flight progress data. For terminal facilities, it may also serve as a clearance for arriving aircraft.

COPTER–

(See HELICOPTER.)

CORRECTION– An error has been made in the transmission and the correct version follows.

COUPLED APPROACH– An instrument approach performed by the aircraft autopilot, and/or visually depicted on the flight director, which is receiving position information and/or steering commands from onboard navigational equipment. In general, coupled non-precision approaches must be flown manually (autopilot disengaged) at altitudes lower than 50 feet AGL below the minimum descent altitude, and coupled precision approaches must be flown manually (autopilot disengaged) below 50 feet AGL unless authorized to conduct autoland operations. Coupled instrument approaches are commonly flown to the allowable IFR weather minima established by the operator or PIC, or flown VFR for training and safety.

COURSE–

a. The intended direction of flight in the horizontal plane measured in degrees from north.

b. The ILS localizer signal pattern usually specified as the front course or the back course.

(See BEARING.)

(See INSTRUMENT LANDING SYSTEM.)

(See RADIAL.)

CPDLC–

(See CONTROLLER PILOT DATA LINK COMMUNICATIONS.)

CPL [ICAO]–

(See ICAO term CURRENT FLIGHT PLAN.)

CRITICAL ENGINE– The engine which, upon failure, would most adversely affect the performance or handling qualities of an aircraft.

CROSS (FIX) AT (ALTITUDE)– Used by ATC when a specific altitude restriction at a specified fix is required.

CROSS (FIX) AT OR ABOVE (ALTITUDE)– Used by ATC when an altitude restriction at a specified fix is required. It does not prohibit the aircraft from crossing the fix at a higher altitude than specified;

however, the higher altitude may not be one that will violate a succeeding altitude restriction or altitude assignment.

(See ALTITUDE RESTRICTION.)

(Refer to AIM.)

CROSS (FIX) AT OR BELOW (ALTITUDE)–

Used by ATC when a maximum crossing altitude at a specific fix is required. It does not prohibit the aircraft from crossing the fix at a lower altitude; however, it must be at or above the minimum IFR altitude.

(See ALTITUDE RESTRICTION.)

(See MINIMUM IFR ALTITUDES.)

(Refer to 14 CFR Part 91.)

CROSSWIND–

a. When used concerning the traffic pattern, the word means “crosswind leg.”

(See TRAFFIC PATTERN.)

b. When used concerning wind conditions, the word means a wind not parallel to the runway or the path of an aircraft.

(See CROSSWIND COMPONENT.)

CROSSWIND COMPONENT– The wind component measured in knots at 90 degrees to the longitudinal axis of the runway.

CRUISE– Used in an ATC clearance to authorize a pilot to conduct flight at any altitude from the minimum IFR altitude up to and including the altitude specified in the clearance. The pilot may level off at any intermediate altitude within this block of airspace. Climb/descent within the block is to be made at the discretion of the pilot. However, once the pilot starts descent and verbally reports leaving an altitude in the block, he/she may not return to that altitude without additional ATC clearance. Further, it is approval for the pilot to proceed to and make an approach at destination airport and can be used in conjunction with:

a. An airport clearance limit at locations with a standard/special instrument approach procedure. The CFRs require that if an instrument letdown to an airport is necessary, the pilot shall make the letdown in accordance with a standard/special instrument approach procedure for that airport, or

b. An airport clearance limit at locations that are within/below/outside controlled airspace and without a standard/special instrument approach procedure. Such a clearance is NOT AUTHORIZA-

TION for the pilot to descend under IFR conditions below the applicable minimum IFR altitude nor does it imply that ATC is exercising control over aircraft in Class G airspace; however, it provides a means for the aircraft to proceed to destination airport, descend, and land in accordance with applicable CFRs governing VFR flight operations. Also, this provides search and rescue protection until such time as the IFR flight plan is closed.

(See INSTRUMENT APPROACH PROCEDURE.)

CRUISE CLIMB– A climb technique employed by aircraft, usually at a constant power setting, resulting in an increase of altitude as the aircraft weight decreases.

CRUISING ALTITUDE– An altitude or flight level maintained during en route level flight. This is a constant altitude and should not be confused with a cruise clearance.

(See ALTITUDE.)

(See ICAO term CRUISING LEVEL.)

CRUISING LEVEL–

(See CRUISING ALTITUDE.)

CRUISING LEVEL [ICAO]– A level maintained during a significant portion of a flight.

CT MESSAGE– An EDCT time generated by the ATCSCC to regulate traffic at arrival airports. Normally, a CT message is automatically transferred from the traffic management system computer to the NAS en route computer and appears as an EDCT. In the event of a communication failure between the traffic management system computer and the NAS, the CT message can be manually entered by the TMC at the en route facility.

CTA–

(See CONTROLLED TIME OF ARRIVAL.)

(See ICAO term CONTROL AREA.)

CTAF–

(See COMMON TRAFFIC ADVISORY FREQUENCY.)

CTAS–

(See CENTER TRACON AUTOMATION SYSTEM.)

CTOP–

(See COLLABORATIVE TRAJECTORY OPTIONS PROGRAM)

CTRD–

(See CERTIFIED TOWER RADAR DISPLAY.)

CURRENT FLIGHT PLAN [ICAO]– The flight plan, including changes, if any, brought about by subsequent clearances.

CURRENT PLAN– The ATC clearance the aircraft has received and is expected to fly.

CVFP APPROACH–
(See CHARTED VISUAL FLIGHT PROCEDURE APPROACH.)

CWA–
(See CENTER WEATHER ADVISORY and WEATHER ADVISORY.)

D

D-ATIS-

(See DIGITAL-AUTOMATIC TERMINAL INFORMATION SERVICE.)

D-ATIS [ICAO]-

(See ICAO Term DATA LINK AUTOMATIC TERMINAL INFORMATION SERVICE.)

DA [ICAO]-

(See ICAO Term DECISION ALTITUDE/DECISION HEIGHT.)

DAIR-

(See DIRECT ALTITUDE AND IDENTITY READOUT.)

DANGER AREA [ICAO]- An airspace of defined dimensions within which activities dangerous to the flight of aircraft may exist at specified times.

Note: The term "Danger Area" is not used in reference to areas within the United States or any of its possessions or territories.

DAS-

(See DELAY ASSIGNMENT.)

DATA BLOCK-

(See ALPHANUMERIC DISPLAY.)

DATA LINK AUTOMATIC TERMINAL INFORMATION SERVICE (D-ATIS) [ICAO]- The provision of ATIS via data link.

DEAD RECKONING- Dead reckoning, as applied to flying, is the navigation of an airplane solely by means of computations based on airspeed, course, heading, wind direction, and speed, groundspeed, and elapsed time.

DECISION ALTITUDE/DECISION HEIGHT [ICAO Annex 6]- A specified altitude or height (A/H) in the precision approach at which a missed approach must be initiated if the required visual reference to continue the approach has not been established.

1. Decision altitude (DA) is referenced to mean sea level and decision height (DH) is referenced to the threshold elevation.

2. Category II and III minima are expressed as a DH and not a DA. Minima is assessed by reference to a radio altimeter and not a barometric altimeter, which makes the minima a DH.

3. The required visual reference means that section of the visual aids or of the approach area which should have been in view for sufficient time for the pilot to have made an assessment of the aircraft position and rate of change of position, in relation to the desired flight path.

DECISION ALTITUDE (DA)- A specified altitude (mean sea level (MSL)) on an instrument approach procedure (ILS, GLS, vertically guided RNAV) at which the pilot must decide whether to continue the approach or initiate an immediate missed approach if the pilot does not see the required visual references.

DECISION HEIGHT (DH)- With respect to the operation of aircraft, means the height at which a decision must be made during an ILS or PAR instrument approach to either continue the approach or to execute a missed approach.

(See ICAO term DECISION ALTITUDE/DECISION HEIGHT.)

DECODER- The device used to decipher signals received from ATCRBS transponders to effect their display as select codes.

(See CODES.)

(See RADAR.)

DEFENSE AREA- Any airspace of the contiguous United States that is not an ADIZ in which the control of aircraft is required for reasons of national security.

DEFENSE VISUAL FLIGHT RULES- Rules applicable to flights within an ADIZ conducted under the visual flight rules in 14 CFR Part 91.

(See AIR DEFENSE IDENTIFICATION ZONE.)

(Refer to 14 CFR Part 91.)

(Refer to 14 CFR Part 99.)

DELAY ASSIGNMENT (DAS)- Delays are distributed to aircraft based on the traffic management program parameters. The delay assignment is calculated in 15-minute increments and appears as a table in Traffic Flow Management System (TFMS).

DELAY INDEFINITE (REASON IF KNOWN) EXPECT FURTHER CLEARANCE (TIME)-

Used by ATC to inform a pilot when an accurate estimate of the delay time and the reason for the delay cannot immediately be determined; e.g., a disabled

aircraft on the runway, terminal or center area saturation, weather below landing minimums, etc.

(See EXPECT FURTHER CLEARANCE (TIME).)

DELAY TIME– The amount of time that the arrival must lose to cross the meter fix at the assigned meter fix time. This is the difference between ACLT and VTA.

DEPARTURE CENTER– The ARTCC having jurisdiction for the airspace that generates a flight to the impacted airport.

DEPARTURE CONTROL– A function of an approach control facility providing air traffic control service for departing IFR and, under certain conditions, VFR aircraft.

(See APPROACH CONTROL FACILITY.)

(Refer to AIM.)

DEPARTURE SEQUENCING PROGRAM– A program designed to assist in achieving a specified interval over a common point for departures.

DEPARTURE TIME– The time an aircraft becomes airborne.

DESCEND VIA– An abbreviated ATC clearance that requires compliance with a published procedure lateral path and associated speed restrictions and provides a pilot-discretion descent to comply with published altitude restrictions.

DESCENT SPEED ADJUSTMENTS– Speed deceleration calculations made to determine an accurate VTA. These calculations start at the transition point and use arrival speed segments to the vertex.

DESIGNATED COMMON TRAFFIC ADVISORY FREQUENCY (CTAF) AREA– In Alaska, in addition to being designated for the purpose of carrying out airport advisory practices while operating to or from an airport without an operating airport traffic control tower, a CTAF may also be designated for the purpose of carrying out advisory practices for operations in and through areas with a high volume of VFR traffic.

DESIRED COURSE–

a. True– A predetermined desired course direction to be followed (measured in degrees from true north).

b. Magnetic– A predetermined desired course direction to be followed (measured in degrees from local magnetic north).

DESIRED TRACK– The planned or intended track between two waypoints. It is measured in degrees from either magnetic or true north. The instantaneous angle may change from point to point along the great circle track between waypoints.

DETRESFA (DISTRESS PHASE) [ICAO]– The code word used to designate an emergency phase wherein there is reasonable certainty that an aircraft and its occupants are threatened by grave and imminent danger or require immediate assistance.

DEVIATIONS–

a. A departure from a current clearance, such as an off course maneuver to avoid weather or turbulence.

b. Where specifically authorized in the CFRs and requested by the pilot, ATC may permit pilots to deviate from certain regulations.

DH–

(See DECISION HEIGHT.)

DH [ICAO]–

(See ICAO Term DECISION ALTITUDE/
DECISION HEIGHT.)

DIGITAL-AUTOMATIC TERMINAL INFORMATION SERVICE (D-ATIS)– The service provides text messages to aircraft, airlines, and other users outside the standard reception range of conventional ATIS via landline and data link communications to the cockpit. Also, the service provides a computer-synthesized voice message that can be transmitted to all aircraft within range of existing transmitters. The Terminal Data Link System (TDLS) D-ATIS application uses weather inputs from local automated weather sources or manually entered meteorological data together with preprogrammed menus to provide standard information to users. Airports with D-ATIS capability are listed in the Chart Supplement U.S.

DIGITAL TARGET– A computer-generated symbol representing an aircraft's position, based on a primary return or radar beacon reply, shown on a digital display.

DIGITAL TERMINAL AUTOMATION SYSTEM (DTAS)– A system where digital radar and beacon data is presented on digital displays and the operational program monitors the system performance on a real-time basis.

DIGITIZED TARGET– A computer-generated indication shown on an analog radar display resulting from a primary radar return or a radar beacon reply.

DIRECT– Straight line flight between two navigational aids, fixes, points, or any combination thereof. When used by pilots in describing off-airway routes, points defining direct route segments become compulsory reporting points unless the aircraft is under radar contact.

DIRECTLY BEHIND– An aircraft is considered to be operating directly behind when it is following the actual flight path of the lead aircraft over the surface of the earth except when applying wake turbulence separation criteria.

DISCRETE BEACON CODE–

(See DISCRETE CODE.)

DISCRETE CODE– As used in the Air Traffic Control Radar Beacon System (ATCRBS), any one of the 4096 selectable Mode 3/A aircraft transponder codes except those ending in zero zero; e.g., discrete codes: 0010, 1201, 2317, 7777; nondiscrete codes: 0100, 1200, 7700. Nondiscrete codes are normally reserved for radar facilities that are not equipped with discrete decoding capability and for other purposes such as emergencies (7700), VFR aircraft (1200), etc.

(See RADAR.)

(Refer to AIM.)

DISCRETE FREQUENCY– A separate radio frequency for use in direct pilot-controller communications in air traffic control which reduces frequency congestion by controlling the number of aircraft operating on a particular frequency at one time. Discrete frequencies are normally designated for each control sector in en route/terminal ATC facilities. Discrete frequencies are listed in the Chart Supplement U.S. and the DOD FLIP IFR En Route Supplement.

(See CONTROL SECTOR.)

DISPLACED THRESHOLD– A threshold that is located at a point on the runway other than the designated beginning of the runway.

(See THRESHOLD.)

(Refer to AIM.)

DISTANCE MEASURING EQUIPMENT (DME)– Equipment (airborne and ground) used to measure, in nautical miles, the slant range distance of an aircraft from the DME navigational aid.

(See TACAN.)

(See VORTAC.)

DISTRESS– A condition of being threatened by serious and/or imminent danger and of requiring immediate assistance.

DIVE BRAKES–

(See SPEED BRAKES.)

DIVERSE VECTOR AREA– In a radar environment, that area in which a prescribed departure route is not required as the only suitable route to avoid obstacles. The area in which random radar vectors below the MVA/MIA, established in accordance with the TERPS criteria for diverse departures, obstacles and terrain avoidance, may be issued to departing aircraft.

DIVERSION (DVRSN)– Flights that are required to land at other than their original destination for reasons beyond the control of the pilot/company, e.g. periods of significant weather.

DME–

(See DISTANCE MEASURING EQUIPMENT.)

DME FIX– A geographical position determined by reference to a navigational aid which provides distance and azimuth information. It is defined by a specific distance in nautical miles and a radial, azimuth, or course (i.e., localizer) in degrees magnetic from that aid.

(See DISTANCE MEASURING EQUIPMENT.)

(See FIX.)

DME SEPARATION– Spacing of aircraft in terms of distances (nautical miles) determined by reference to distance measuring equipment (DME).

(See DISTANCE MEASURING EQUIPMENT.)

DOD FLIP– Department of Defense Flight Information Publications used for flight planning, en route, and terminal operations. FLIP is produced by the National Geospatial-Intelligence Agency (NGA) for world-wide use. United States Government Flight Information Publications (en route charts and instrument approach procedure charts) are incorporated in DOD FLIP for use in the National Airspace System (NAS).

DOMESTIC AIRSPACE– Airspace which overlies the continental land mass of the United States plus Hawaii and U.S. possessions. Domestic airspace extends to 12 miles offshore.

DOWNBURST– A strong downdraft which induces an outburst of damaging winds on or near the ground. Damaging winds, either straight or curved, are highly

divergent. The sizes of downbursts vary from 1/2 mile or less to more than 10 miles. An intense downburst often causes widespread damage. Damaging winds, lasting 5 to 30 minutes, could reach speeds as high as 120 knots.

DOWNWIND LEG-

(See **TRAFFIC PATTERN.**)

DP-

(See **INSTRUMENT DEPARTURE PROCEDURE.**)

DRAG CHUTE- A parachute device installed on certain aircraft which is deployed on landing roll to assist in deceleration of the aircraft.

DROP ZONE- Any pre-determined area upon which parachutists or objects land after making an intentional parachute jump or drop.

(Refer to 14 CFR §105.3, Definitions)

DSP-

(See **DEPARTURE SEQUENCING PROGRAM.**)

DT-

(See **DELAY TIME.**)

DTAS-

(See **DIGITAL TERMINAL AUTOMATION SYSTEM.**)

DUE REGARD- A phase of flight wherein an aircraft commander of a State-operated aircraft

assumes responsibility to separate his/her aircraft from all other aircraft.

(See also FAA Order JO 7110.65, Para 1-2-1, **WORD MEANINGS.**)

DUTY RUNWAY-

(See **RUNWAY IN USE/ACTIVE RUNWAY/DUTY RUNWAY.**)

DVA-

(See **DIVERSE VECTOR AREA.**)

DVFR-

(See **DEFENSE VISUAL FLIGHT RULES.**)

DVFR FLIGHT PLAN- A flight plan filed for a VFR aircraft which intends to operate in airspace within which the ready identification, location, and control of aircraft are required in the interest of national security.

DVRSN-

(See **DIVERSION.**)

DYNAMIC- Continuous review, evaluation, and change to meet demands.

DYNAMIC RESTRICTIONS- Those restrictions imposed by the local facility on an "as needed" basis to manage unpredictable fluctuations in traffic demands.

E

EAS–

(See EN ROUTE AUTOMATION SYSTEM.)

EDCT–

(See EXPECT DEPARTURE CLEARANCE TIME.)

EDST–

(See EN ROUTE DECISION SUPPORT TOOL)

EFC–

(See EXPECT FURTHER CLEARANCE (TIME).)

ELT–

(See EMERGENCY LOCATOR TRANSMITTER.)

EMERGENCY– A distress or an urgency condition.

EMERGENCY LOCATOR TRANSMITTER (ELT)– A radio transmitter attached to the aircraft structure which operates from its own power source on 121.5 MHz and 243.0 MHz. It aids in locating downed aircraft by radiating a downward sweeping audio tone, 2-4 times per second. It is designed to function without human action after an accident.

(Refer to 14 CFR Part 91.)

(Refer to AIM.)

E-MSAW–

(See EN ROUTE MINIMUM SAFE ALTITUDE WARNING.)

ENHANCED FLIGHT VISION SYSTEM (EFVS)–

An EFVS is an installed aircraft system which uses an electronic means to provide a display of the forward external scene topography (the natural or man-made features of a place or region especially in a way to show their relative positions and elevation) through the use of imaging sensors, including but not limited to forward-looking infrared, millimeter wave radiometry, millimeter wave radar, or low-light level image intensification. An EFVS includes the display element, sensors, computers and power supplies, indications, and controls. An operator's authorization to conduct an EFVS operation may have provisions which allow pilots to conduct IAPs when the reported weather is below minimums prescribed on the IAP to be flown.

EN ROUTE AIR TRAFFIC CONTROL SERVICES– Air traffic control service provided aircraft on IFR flight plans, generally by centers, when these

aircraft are operating between departure and destination terminal areas. When equipment, capabilities, and controller workload permit, certain advisory/assistance services may be provided to VFR aircraft.

(See AIR ROUTE TRAFFIC CONTROL CENTER.)

(Refer to AIM.)

EN ROUTE AUTOMATION SYSTEM (EAS)– The complex integrated environment consisting of situation display systems, surveillance systems and flight data processing, remote devices, decision support tools, and the related communications equipment that form the heart of the automated IFR air traffic control system. It interfaces with automated terminal systems and is used in the control of en route IFR aircraft.

(Refer to AIM.)

EN ROUTE CHARTS–

(See AERONAUTICAL CHART.)

EN ROUTE DECISION SUPPORT TOOL (EDST)–

An automated tool provided at each Radar Associate position in selected En Route facilities. This tool utilizes flight and radar data to determine present and future trajectories for all active and proposal aircraft and provides enhanced automated flight data management.

EN ROUTE DESCENT– Descent from the en route cruising altitude which takes place along the route of flight.

EN ROUTE HIGH ALTITUDE CHARTS–

(See AERONAUTICAL CHART.)

EN ROUTE LOW ALTITUDE CHARTS–

(See AERONAUTICAL CHART.)

EN ROUTE MINIMUM SAFE ALTITUDE WARN-

ING (E-MSAW)– A function of the EAS that aids the controller by providing an alert when a tracked aircraft is below or predicted by the computer to go below a predetermined minimum IFR altitude (MIA).

EN ROUTE SPACING PROGRAM (ESP)– A program designed to assist the exit sector in achieving the required in-trail spacing.

EN ROUTE TRANSITION–

a. Conventional STARs/SIDs. The portion of a SID/STAR that connects to one or more en route airway/jet route.

b. RNAV STARs/SIDs. The portion of a STAR preceding the common route or point, or for a SID the portion following, that is coded for a specific en route fix, airway or jet route.

ESP–

(See EN ROUTE SPACING PROGRAM.)

EST–

(See ESTIMATED.)

ESTABLISHED– To be stable or fixed at an altitude or on a course, route, route segment, heading, instrument approach or departure procedure, etc.

ESTABLISHED ON RNP (EoR) CONCEPT– A system of authorized instrument approaches, ATC procedures, surveillance, and communication requirements that allow aircraft operations to be safely conducted with approved reduced separation criteria once aircraft are established on a PBN segment of a published instrument flight procedure.

ESTIMATED (EST)–When used in NOTAMs “EST” is a contraction that is used by the issuing authority only when the condition is expected to return to service prior to the expiration time. Using “EST” lets the user know that this NOTAM has the possibility of returning to service earlier than the expiration time. Any NOTAM which includes an “EST” will be auto-expired at the designated expiration time.

ESTIMATED ELAPSED TIME [ICAO]– The estimated time required to proceed from one significant point to another.

(See ICAO Term TOTAL ESTIMATED ELAPSED TIME.)

ESTIMATED OFF-BLOCK TIME [ICAO]– The estimated time at which the aircraft will commence movement associated with departure.

ESTIMATED POSITION ERROR (EPE)–

(See Required Navigation Performance)

ESTIMATED TIME OF ARRIVAL– The time the flight is estimated to arrive at the gate (scheduled operators) or the actual runway on times for nonscheduled operators.

ESTIMATED TIME EN ROUTE– The estimated flying time from departure point to destination (lift-off to touchdown).

ETA–

(See ESTIMATED TIME OF ARRIVAL.)

ETE–

(See ESTIMATED TIME EN ROUTE.)

EXECUTE MISSED APPROACH– Instructions issued to a pilot making an instrument approach which means continue inbound to the missed approach point and execute the missed approach procedure as described on the Instrument Approach Procedure Chart or as previously assigned by ATC. The pilot may climb immediately to the altitude specified in the missed approach procedure upon making a missed approach. No turns should be initiated prior to reaching the missed approach point. When conducting an ASR or PAR approach, execute the assigned missed approach procedure immediately upon receiving instructions to “execute missed approach.”

(Refer to AIM.)

EXPECT (ALTITUDE) AT (TIME) or (FIX)– Used under certain conditions to provide a pilot with an altitude to be used in the event of two-way communications failure. It also provides altitude information to assist the pilot in planning.

(Refer to AIM.)

EXPECT DEPARTURE CLEARANCE TIME (EDCT)– The runway release time assigned to an aircraft in a traffic management program and shown on the flight progress strip as an EDCT.

(See GROUND DELAY PROGRAM.)

EXPECT FURTHER CLEARANCE (TIME)– The time a pilot can expect to receive clearance beyond a clearance limit.

EXPECT FURTHER CLEARANCE VIA (AIRWAYS, ROUTES OR FIXES)– Used to inform a pilot of the routing he/she can expect if any part of the route beyond a short range clearance limit differs from that filed.

EXPEDITE– Used by ATC when prompt compliance is required to avoid the development of an imminent situation. Expedite climb/descent normally indicates to a pilot that the approximate best rate of climb/descent should be used without requiring an exceptional change in aircraft handling characteristics.

F

FAF–

(See FINAL APPROACH FIX.)

FALLEN HERO– Remains of fallen members of the United States military are often returned home by aircraft. These flights may be identified with the phrase “FALLEN HERO” added to the remarks section of the flight plan, or they may be transmitted via air/ground communications. If able, these flights will receive priority handling.

FAST FILE– An FSS system whereby a pilot files a flight plan via telephone that is recorded and later transcribed for transmission to the appropriate air traffic facility. (Alaska only.)

FAWP– Final Approach Waypoint

FCLT–

(See FREEZE CALCULATED LANDING TIME.)

FEATHERED PROPELLER– A propeller whose blades have been rotated so that the leading and trailing edges are nearly parallel with the aircraft flight path to stop or minimize drag and engine rotation. Normally used to indicate shutdown of a reciprocating or turboprop engine due to malfunction.

FEDERAL AIRWAYS–

(See LOW ALTITUDE AIRWAY STRUCTURE.)

FEEDER FIX– The fix depicted on Instrument Approach Procedure Charts which establishes the starting point of the feeder route.

FEEDER ROUTE– A route depicted on instrument approach procedure charts to designate routes for aircraft to proceed from the en route structure to the initial approach fix (IAF).

(See INSTRUMENT APPROACH PROCEDURE.)

FERRY FLIGHT– A flight for the purpose of:

- a. Returning an aircraft to base.
- b. Delivering an aircraft from one location to another.
- c. Moving an aircraft to and from a maintenance base. Ferry flights, under certain conditions, may be conducted under terms of a special flight permit.

FIELD ELEVATION–

(See AIRPORT ELEVATION.)

FILED– Normally used in conjunction with flight plans, meaning a flight plan has been submitted to ATC.

FILED EN ROUTE DELAY– Any of the following preplanned delays at points/areas along the route of flight which require special flight plan filing and handling techniques.

a. Terminal Area Delay. A delay within a terminal area for touch-and-go, low approach, or other terminal area activity.

b. Special Use Airspace Delay. A delay within a Military Operations Area, Restricted Area, Warning Area, or ATC Assigned Airspace.

c. Aerial Refueling Delay. A delay within an Aerial Refueling Track or Anchor.

FILED FLIGHT PLAN– The flight plan as filed with an ATS unit by the pilot or his/her designated representative without any subsequent changes or clearances.

FINAL– Commonly used to mean that an aircraft is on the final approach course or is aligned with a landing area.

(See FINAL APPROACH COURSE.)

(See FINAL APPROACH-IFR.)

(See SEGMENTS OF AN INSTRUMENT APPROACH PROCEDURE.)

FINAL APPROACH [ICAO]– That part of an instrument approach procedure which commences at the specified final approach fix or point, or where such a fix or point is not specified.

a. At the end of the last procedure turn, base turn or inbound turn of a racetrack procedure, if specified; or

b. At the point of interception of the last track specified in the approach procedure; and ends at a point in the vicinity of an aerodrome from which:

1. A landing can be made; or
2. A missed approach procedure is initiated.

FINAL APPROACH COURSE– A bearing/radial/track of an instrument approach leading to a runway or an extended runway centerline all without regard to distance.

FINAL APPROACH FIX– The fix from which the final approach (IFR) to an airport is executed and which identifies the beginning of the final approach segment. It is designated on Government charts by the Maltese Cross symbol for nonprecision approaches and the lightning bolt symbol, designating the PFAF, for precision approaches; or when ATC directs a lower-than-published glideslope/path or vertical path intercept altitude, it is the resultant actual point of the glideslope/path or vertical path intercept.

(See FINAL APPROACH POINT.)

(See GLIDESLOPE INTERCEPT ALTITUDE.)

(See SEGMENTS OF AN INSTRUMENT APPROACH PROCEDURE.)

FINAL APPROACH-IFR– The flight path of an aircraft which is inbound to an airport on a final instrument approach course, beginning at the final approach fix or point and extending to the airport or the point where a circle-to-land maneuver or a missed approach is executed.

(See FINAL APPROACH COURSE.)

(See FINAL APPROACH FIX.)

(See FINAL APPROACH POINT.)

(See SEGMENTS OF AN INSTRUMENT APPROACH PROCEDURE.)

(See ICAO term FINAL APPROACH.)

FINAL APPROACH POINT– The point, applicable only to a nonprecision approach with no depicted FAF (such as an on airport VOR), where the aircraft is established inbound on the final approach course from the procedure turn and where the final approach descent may be commenced. The FAP serves as the FAF and identifies the beginning of the final approach segment.

(See FINAL APPROACH FIX.)

(See SEGMENTS OF AN INSTRUMENT APPROACH PROCEDURE.)

FINAL APPROACH SEGMENT–

(See SEGMENTS OF AN INSTRUMENT APPROACH PROCEDURE.)

FINAL APPROACH SEGMENT [ICAO]– That segment of an instrument approach procedure in which alignment and descent for landing are accomplished.

FINAL CONTROLLER– The controller providing information and final approach guidance during PAR and ASR approaches utilizing radar equipment.

(See RADAR APPROACH.)

FINAL GUARD SERVICE– A value added service provided in conjunction with LAA/RAA only during periods of significant and fast changing weather conditions that may affect landing and takeoff operations.

FINAL MONITOR AID– A high resolution color display that is equipped with the controller alert system hardware/software used to monitor the no transgression zone (NTZ) during simultaneous parallel approach operations. The display includes alert algorithms providing the target predictors, a color change alert when a target penetrates or is predicted to penetrate the no transgression zone (NTZ), synthesized voice alerts, and digital mapping.

(See RADAR APPROACH.)

FINAL MONITOR CONTROLLER– Air Traffic Control Specialist assigned to radar monitor the flight path of aircraft during simultaneous parallel (approach courses spaced less than 9000 feet/9200 feet above 5000 feet) and simultaneous close parallel approach operations. Each runway is assigned a final monitor controller during simultaneous parallel and simultaneous close parallel ILS approaches.

FIR–

(See FLIGHT INFORMATION REGION.)

FIRST TIER CENTER– An ARTCC immediately adjacent to the impacted center.

FIS-B–

(See FLIGHT INFORMATION SERVICE-BROADCAST.)

FIX– A geographical position determined by visual reference to the surface, by reference to one or more radio NAVAIDs, by celestial plotting, or by another navigational device.

FIX BALANCING– A process whereby aircraft are evenly distributed over several available arrival fixes reducing delays and controller workload.

FLAG– A warning device incorporated in certain airborne navigation and flight instruments indicating that:

a. Instruments are inoperative or otherwise not operating satisfactorily, or

b. Signal strength or quality of the received signal falls below acceptable values.

FLAG ALARM–

(See FLAG.)

FLAMEOUT– An emergency condition caused by a loss of engine power.

FLAMEOUT PATTERN– An approach normally conducted by a single-engine military aircraft experiencing loss or anticipating loss of engine power or control. The standard overhead approach starts at a relatively high altitude over a runway (“high key”) followed by a continuous 180 degree turn to a high, wide position (“low key”) followed by a continuous 180 degree turn final. The standard straight-in pattern starts at a point that results in a straight-in approach with a high rate of descent to the runway. Flameout approaches terminate in the type approach requested by the pilot (normally fullstop).

FLIGHT CHECK– A call sign prefix used by FAA aircraft engaged in flight inspection/certification of navigational aids and flight procedures. The word “recorded” may be added as a suffix; e.g., “Flight Check 320 recorded” to indicate that an automated flight inspection is in progress in terminal areas.

(See FLIGHT INSPECTION.)

(Refer to AIM.)

FLIGHT FOLLOWING–

(See TRAFFIC ADVISORIES.)

FLIGHT INFORMATION REGION– An airspace of defined dimensions within which Flight Information Service and Alerting Service are provided.

a. Flight Information Service. A service provided for the purpose of giving advice and information useful for the safe and efficient conduct of flights.

b. Alerting Service. A service provided to notify appropriate organizations regarding aircraft in need of search and rescue aid and to assist such organizations as required.

FLIGHT INFORMATION SERVICE– A service provided for the purpose of giving advice and information useful for the safe and efficient conduct of flights.

FLIGHT INFORMATION SERVICE– BROADCAST (FIS–B)– A ground broadcast service provided through the ADS–B Broadcast Services

network over the UAT data link that operates on 978 MHz. The FIS–B system provides pilots and flight crews of properly equipped aircraft with a cockpit display of certain aviation weather and aeronautical information.

FLIGHT INSPECTION– Inflight investigation and evaluation of a navigational aid to determine whether it meets established tolerances.

(See FLIGHT CHECK.)

(See NAVIGATIONAL AID.)

FLIGHT LEVEL– A level of constant atmospheric pressure related to a reference datum of 29.92 inches of mercury. Each is stated in three digits that represent hundreds of feet. For example, flight level (FL) 250 represents a barometric altimeter indication of 25,000 feet; FL 255, an indication of 25,500 feet.

(See ICAO term FLIGHT LEVEL.)

FLIGHT LEVEL [ICAO]– A surface of constant atmospheric pressure which is related to a specific pressure datum, 1013.2 hPa (1013.2 mb), and is separated from other such surfaces by specific pressure intervals.

Note 1: A pressure type altimeter calibrated in accordance with the standard atmosphere:

- a.** When set to a QNH altimeter setting, will indicate altitude;
- b.** When set to a QFE altimeter setting, will indicate height above the QFE reference datum; and
- c.** When set to a pressure of 1013.2 hPa (1013.2 mb), may be used to indicate flight levels.

Note 2: The terms ‘height’ and ‘altitude,’ used in Note 1 above, indicate altimetric rather than geometric heights and altitudes.

FLIGHT LINE– A term used to describe the precise movement of a civil photogrammetric aircraft along a predetermined course(s) at a predetermined altitude during the actual photographic run.

FLIGHT MANAGEMENT SYSTEMS– A computer system that uses a large data base to allow routes to be preprogrammed and fed into the system by means of a data loader. The system is constantly updated with respect to position accuracy by reference to conventional navigation aids. The sophisticated program and its associated data base ensures that the most appropriate aids are automatically selected during the information update cycle.

FLIGHT PATH– A line, course, or track along which an aircraft is flying or intended to be flown.

(See **COURSE**.)

(See **TRACK**.)

FLIGHT PLAN– Specified information relating to the intended flight of an aircraft that is filed orally or in writing with an FSS or an ATC facility.

(See **FAST FILE**.)

(See **FILED**.)

(Refer to **AIM**.)

FLIGHT PLAN AREA (FPA)– The geographical area assigned to a flight service station (FSS) for the purpose of establishing primary responsibility for services that may include search and rescue for VFR aircraft, issuance of NOTAMS, pilot briefings, inflight services, broadcast services, emergency services, flight data processing, international operations, and aviation weather services. Large consolidated FSS facilities may combine FPAs into larger areas of responsibility (AOR).

(See **FLIGHT SERVICE STATION**.)

(See **TIE-IN FACILITY**.)

FLIGHT RECORDER– A general term applied to any instrument or device that records information about the performance of an aircraft in flight or about conditions encountered in flight. Flight recorders may make records of airspeed, outside air temperature, vertical acceleration, engine RPM, manifold pressure, and other pertinent variables for a given flight.

(See ICAO term **FLIGHT RECORDER**.)

FLIGHT RECORDER [ICAO]– Any type of recorder installed in the aircraft for the purpose of complementing accident/incident investigation.

Note: See Annex 6 Part I, for specifications relating to flight recorders.

FLIGHT SERVICE STATION (FSS)– An air traffic facility which provides pilot briefings, flight plan processing, en route flight advisories, search and rescue services, and assistance to lost aircraft and aircraft in emergency situations. FSS also relay ATC clearances, process Notices to Airmen, broadcast aviation weather and aeronautical information, and advise Customs and Immigration of transborder flights. In Alaska, FSS provide Airport Advisory Services.

(See **FLIGHT PLAN AREA**.)

(See **TIE-IN FACILITY**.)

FLIGHT STANDARDS DISTRICT OFFICE– An FAA field office serving an assigned geographical area and staffed with Flight Standards personnel who serve the aviation industry and the general public on matters relating to the certification and operation of air carrier and general aviation aircraft. Activities include general surveillance of operational safety, certification of airmen and aircraft, accident prevention, investigation, enforcement, etc.

FLIGHT TERMINATION– The intentional and deliberate process of terminating the flight of a UA in the event of an unrecoverable lost link, loss of control, or other failure that compromises the safety of flight.

FLIGHT TEST– A flight for the purpose of:

a. Investigating the operation/flight characteristics of an aircraft or aircraft component.

b. Evaluating an applicant for a pilot certificate or rating.

FLIGHT VISIBILITY–

(See **VISIBILITY**.)

FLIP–

(See **DOD FLIP**.)

FLY HEADING (DEGREES)– Informs the pilot of the heading he/she should fly. The pilot may have to turn to, or continue on, a specific compass direction in order to comply with the instructions. The pilot is expected to turn in the shorter direction to the heading unless otherwise instructed by ATC.

FLY-BY WAYPOINT– A fly-by waypoint requires the use of turn anticipation to avoid overshoot of the next flight segment.

FLY-OVER WAYPOINT– A fly-over waypoint precludes any turn until the waypoint is overflown and is followed by an intercept maneuver of the next flight segment.

FLY VISUAL TO AIRPORT–

(See **PUBLISHED INSTRUMENT APPROACH PROCEDURE VISUAL SEGMENT**.)

FMA–

(See **FINAL MONITOR AID**.)

FMS–

(See **FLIGHT MANAGEMENT SYSTEM**.)

FORMATION FLIGHT– More than one aircraft which, by prior arrangement between the pilots, operate as a single aircraft with regard to navigation

and position reporting. Separation between aircraft within the formation is the responsibility of the flight leader and the pilots of the other aircraft in the flight. This includes transition periods when aircraft within the formation are maneuvering to attain separation from each other to effect individual control and during join-up and breakaway.

a. A standard formation is one in which a proximity of no more than 1 mile laterally or longitudinally and within 100 feet vertically from the flight leader is maintained by each wingman.

b. Nonstandard formations are those operating under any of the following conditions:

1. When the flight leader has requested and ATC has approved other than standard formation dimensions.

2. When operating within an authorized altitude reservation (ALTRV) or under the provisions of a letter of agreement.

3. When the operations are conducted in airspace specifically designed for a special activity.
(See ALTITUDE RESERVATION.)
(Refer to 14 CFR Part 91.)

FRC–

(See REQUEST FULL ROUTE CLEARANCE.)

FREEZE/FROZEN– Terms used in referring to arrivals which have been assigned ACLTs and to the lists in which they are displayed.

FREEZE CALCULATED LANDING TIME– A dynamic parameter number of minutes prior to the meter fix calculated time of arrival for each aircraft when the TCLT is frozen and becomes an ACLT (i.e., the VTA is updated and consequently the TCLT is modified as appropriate until FCLT minutes prior to meter fix calculated time of arrival, at which time updating is suspended and an ACLT and a frozen meter fix crossing time (MFT) is assigned).

FREEZE HORIZON– The time or point at which an aircraft's STA becomes fixed and no longer fluctuates with each radar update. This setting ensures a constant time for each aircraft, necessary for the metering controller to plan his/her delay technique. This setting can be either in distance from the meter fix or a prescribed flying time to the meter fix.

FREEZE SPEED PARAMETER– A speed adapted for each aircraft to determine fast and slow aircraft.

Fast aircraft freeze on parameter FCLT and slow aircraft freeze on parameter MLDI.

FRICITION MEASUREMENT– A measurement of the friction characteristics of the runway pavement surface using continuous self-watering friction measurement equipment in accordance with the specifications, procedures and schedules contained in AC 150/5320–12, Measurement, Construction, and Maintenance of Skid Resistant Airport Pavement Surfaces.

FSDO–

(See FLIGHT STANDARDS DISTRICT OFFICE.)

FSPD–

(See FREEZE SPEED PARAMETER.)

FSS–

(See FLIGHT SERVICE STATION.)

FUEL DUMPING– Airborne release of usable fuel. This does not include the dropping of fuel tanks.

(See JETTISONING OF EXTERNAL STORES.)

FUEL REMAINING– A phrase used by either pilots or controllers when relating to the fuel remaining on board until actual fuel exhaustion. When transmitting such information in response to either a controller question or pilot initiated cautionary advisory to air traffic control, pilots will state the APPROXIMATE NUMBER OF MINUTES the flight can continue with the fuel remaining. All reserve fuel SHOULD BE INCLUDED in the time stated, as should an allowance for established fuel gauge system error.

FUEL SIPHONING– Unintentional release of fuel caused by overflow, puncture, loose cap, etc.

FUEL VENTING–

(See FUEL SIPHONING.)

FUSED TARGET–

(See DIGITAL TARGET)

FUSION [STARS/CARTS]– the combination of all available surveillance sources (airport surveillance radar [ASR], air route surveillance radar [ARSR], ADS-B, etc.) into the display of a single tracked target for air traffic control separation services. FUSION is the equivalent of the current single-sensor radar display. FUSION performance is characteristic of a single-sensor radar display system. Terminal areas use mono-pulse secondary surveillance radar (ASR 9, Mode S or ASR 11, MSSR).

G

GATE HOLD PROCEDURES– Procedures at selected airports to hold aircraft at the gate or other ground location whenever departure delays exceed or are anticipated to exceed 15 minutes. The sequence for departure will be maintained in accordance with initial call-up unless modified by flow control restrictions. Pilots should monitor the ground control/clearance delivery frequency for engine start/taxi advisories or new proposed start/taxi time if the delay changes.

GBT–

(See **GROUND-BASED TRANSCEIVER**.)

GCA–

(See **GROUND CONTROLLED APPROACH**.)

GDP–

(See **GROUND DELAY PROGRAM**.)

GENERAL AVIATION– That portion of civil aviation that does not include scheduled or unscheduled air carriers or commercial space operations.

(See ICAO term **GENERAL AVIATION**.)

GENERAL AVIATION [ICAO]– All civil aviation operations other than scheduled air services and nonscheduled air transport operations for remuneration or hire.

GEO MAP– The digitized map markings associated with the ASR-9 Radar System.

GLIDEPATH–

(See **GLIDESLOPE**.)

GLIDEPATH [ICAO]– A descent profile determined for vertical guidance during a final approach.

GLIDEPATH INTERCEPT ALTITUDE–

(See **GLIDESLOPE INTERCEPT ALTITUDE**.)

GLIDESLOPE– Provides vertical guidance for aircraft during approach and landing. The glideslope/glidepath is based on the following:

a. Electronic components emitting signals which provide vertical guidance by reference to airborne instruments during instrument approaches such as ILS; or,

b. Visual ground aids, such as VASI, which provide vertical guidance for a VFR approach or for the visual portion of an instrument approach and landing.

c. **PAR**. Used by ATC to inform an aircraft making a PAR approach of its vertical position (elevation) relative to the descent profile.

(See ICAO term **GLIDEPATH**.)

GLIDESLOPE INTERCEPT ALTITUDE– The published minimum altitude to intercept the glideslope in the intermediate segment of an instrument approach. Government charts use the lightning bolt symbol to identify this intercept point. This intersection is called the Precise Final Approach fix (PFAF). ATC directs a higher altitude, the resultant intercept becomes the PFAF.

(See **FINAL APPROACH FIX**.)

(See **SEGMENTS OF AN INSTRUMENT APPROACH PROCEDURE**.)

GLOBAL NAVIGATION SATELLITE SYSTEM (GNSS) [ICAO]– GNSS refers collectively to the worldwide positioning, navigation, and timing determination capability available from one or more satellite constellation in conjunction with a network of ground stations.

GLOBAL NAVIGATION SATELLITE SYSTEM MINIMUM EN ROUTE IFR ALTITUDE (GNSS MEA)– The minimum en route IFR altitude on a published ATS route or route segment which assures acceptable Global Navigation Satellite System reception and meets obstacle clearance requirements. (Refer to 14 CFR Part 91.) (Refer to 14 CFR Part 95.)

GLOBAL POSITIONING SYSTEM (GPS)– GPS refers to the worldwide positioning, navigation and timing determination capability available from the U.S. satellite constellation. The service provided by GPS for civil use is defined in the GPS Standard Positioning System Performance Standard. GPS is composed of space, control, and user elements.

GNSS [ICAO]–

(See **GLOBAL NAVIGATION SATELLITE SYSTEM**.)

GNSS MEA–

(See GLOBAL NAVIGATION SATELLITE SYSTEM MINIMUM EN ROUTE IFR ALTITUDE.)

GO AHEAD– Proceed with your message. Not to be used for any other purpose.

GO AROUND– Instructions for a pilot to abandon his/her approach to landing. Additional instructions may follow. Unless otherwise advised by ATC, a VFR aircraft or an aircraft conducting visual approach should overfly the runway while climbing to traffic pattern altitude and enter the traffic pattern via the crosswind leg. A pilot on an IFR flight plan making an instrument approach should execute the published missed approach procedure or proceed as instructed by ATC; e.g., “Go around” (additional instructions if required).

(See LOW APPROACH.)

(See MISSED APPROACH.)

GPD–

(See GRAPHIC PLAN DISPLAY.)

GPS–

(See GLOBAL POSITIONING SYSTEM.)

GRAPHIC PLAN DISPLAY (GPD)– A view available with EDST that provides a graphic display of aircraft, traffic, and notification of predicted conflicts. Graphic routes for Current Plans and Trial Plans are displayed upon controller request.

(See EN ROUTE DECISION SUPPORT TOOL.)

GROSS NAVIGATION ERROR (GNE) – A lateral deviation from a cleared track, normally in excess of 25 Nautical Miles (NM). More stringent standards (for example, 10NM in some parts of the North Atlantic region) may be used in certain regions to support reductions in lateral separation.

GROUND BASED AUGMENTATION SYSTEM (GBAS)– A ground based GNSS station which provides local differential corrections, integrity parameters and approach data via VHF data broadcast to GNSS users to meet real-time performance requirements for CAT I precision approaches. The aircraft applies the broadcast data to improve the accuracy and integrity of its GNSS signals and computes the deviations to the selected approach. A single ground station can serve multiple runway ends up to an approximate radius of 23 NM.

GROUND BASED AUGMENTATION SYSTEM (GBAS) LANDING SYSTEM (GLS)– A type of precision IAP based on local augmentation of GNSS data using a single GBAS station to transmit locally corrected GNSS data, integrity parameters and approach information. This improves the accuracy of aircraft GNSS receivers’ signal in space, enabling the pilot to fly a precision approach with much greater flexibility, reliability and complexity. The GLS procedure is published on standard IAP charts, features the title GLS with the designated runway and minima as low as 200 feet DA. Future plans are expected to support Cat II and CAT III operations.

GROUND-BASED TRANSCEIVER (GBT)– The ground-based transmitter/receiver (transceiver) receives automatic dependent surveillance-broadcast messages, which are forwarded to an air traffic control facility for processing and display with other radar targets on the plan position indicator (radar display).

(See AUTOMATIC DEPENDENT SURVEILLANCE-BROADCAST.)

GROUND CLUTTER– A pattern produced on the radar scope by ground returns which may degrade other radar returns in the affected area. The effect of ground clutter is minimized by the use of moving target indicator (MTI) circuits in the radar equipment resulting in a radar presentation which displays only targets which are in motion.

(See CLUTTER.)

GROUND COMMUNICATION OUTLET (GCO)– An unstaffed, remotely controlled, ground/ground communications facility. Pilots at uncontrolled airports may contact ATC and FSS via VHF to a telephone connection to obtain an instrument clearance or close a VFR or IFR flight plan. They may also get an updated weather briefing prior to takeoff. Pilots will use four “key clicks” on the VHF radio to contact the appropriate ATC facility or six “key clicks” to contact the FSS. The GCO system is intended to be used only on the ground.

GROUND CONTROLLED APPROACH– A radar approach system operated from the ground by air traffic control personnel transmitting instructions to the pilot by radio. The approach may be conducted with surveillance radar (ASR) only or with both surveillance and precision approach radar (PAR). Usage of the term “GCA” by pilots is discouraged except when referring to a GCA facility. Pilots should specifically request a “PAR” approach when a

precision radar approach is desired or request an “ASR” or “surveillance” approach when a nonprecision radar approach is desired.

(See RADAR APPROACH.)

GROUND DELAY PROGRAM (GDP)– A traffic management process administered by the ATCSCC, when aircraft are held on the ground. The purpose of the program is to support the TM mission and limit airborne holding. It is a flexible program and may be implemented in various forms depending upon the needs of the AT system. Ground delay programs provide for equitable assignment of delays to all system users.

GROUND SPEED– The speed of an aircraft relative

to the surface of the earth.

GROUND STOP (GS)– The GS is a process that requires aircraft that meet a specific criteria to remain on the ground. The criteria may be airport specific, airspace specific, or equipment specific; for example, all departures to San Francisco, or all departures entering Yorktown sector, or all Category I and II aircraft going to Charlotte. GSs normally occur with little or no warning.

GROUND VISIBILITY–

(See VISIBILITY.)

GS–

(See GROUND STOP.)

H

HAA–

(See HEIGHT ABOVE AIRPORT.)

HAL–

(See HEIGHT ABOVE LANDING.)

HANDOFF– An action taken to transfer the radar identification of an aircraft from one controller to another if the aircraft will enter the receiving controller’s airspace and radio communications with the aircraft will be transferred.

HAR–

(See HIGH ALTITUDE REDESIGN.)

HAT–

(See HEIGHT ABOVE TOUCHDOWN.)

HAVE NUMBERS– Used by pilots to inform ATC that they have received runway, wind, and altimeter information only.

HAZARDOUS INFLIGHT WEATHER ADVISORY SERVICE (HIWAS)– Continuous recorded hazardous inflight weather forecasts broadcasted to airborne pilots over selected VOR outlets defined as an HIWAS BROADCAST AREA.

HAZARDOUS WEATHER INFORMATION– Summary of significant meteorological information (SIGMET/WS), convective significant meteorological information (convective SIGMET/WST), urgent pilot weather reports (urgent PIREP/UUA), center weather advisories (CWA), airmen’s meteorological information (AIRMET/WA) and any other weather such as isolated thunderstorms that are rapidly developing and increasing in intensity, or low ceilings and visibilities that are becoming widespread which is considered significant and are not included in a current hazardous weather advisory.

HEAVY (AIRCRAFT)–

(See AIRCRAFT CLASSES.)

HEIGHT ABOVE AIRPORT (HAA)– The height of the Minimum Descent Altitude above the published airport elevation. This is published in conjunction with circling minimums.

(See MINIMUM DESCENT ALTITUDE.)

HEIGHT ABOVE LANDING (HAL)– The height above a designated helicopter landing area used for helicopter instrument approach procedures.

(Refer to 14 CFR Part 97.)

HEIGHT ABOVE TOUCHDOWN (HAT)– The height of the Decision Height or Minimum Descent Altitude above the highest runway elevation in the touchdown zone (first 3,000 feet of the runway). HAT is published on instrument approach charts in conjunction with all straight-in minimums.

(See DECISION HEIGHT.)

(See MINIMUM DESCENT ALTITUDE.)

HELICOPTER– A heavier-than-air aircraft supported in flight chiefly by the reactions of the air on one or more power-driven rotors on substantially vertical axes.

HELIPAD– A small, designated area, usually with a prepared surface, on a heliport, airport, landing/take-off area, apron/ramp, or movement area used for takeoff, landing, or parking of helicopters.

HELIPORT– An area of land, water, or structure used or intended to be used for the landing and takeoff of helicopters and includes its buildings and facilities if any.

HELIPORT REFERENCE POINT (HRP)– The geographic center of a heliport.

HERTZ– The standard radio equivalent of frequency in cycles per second of an electromagnetic wave. Kilohertz (kHz) is a frequency of one thousand cycles per second. Megahertz (MHz) is a frequency of one million cycles per second.

HF–

(See HIGH FREQUENCY.)

HF COMMUNICATIONS–

(See HIGH FREQUENCY COMMUNICATIONS.)

HIGH ALTITUDE REDESIGN (HAR)– A level of non-restrictive routing (NRR) service for aircraft that have all waypoints associated with the HAR program in their flight management systems or RNAV equipage.

HIGH FREQUENCY– The frequency band between 3 and 30 MHz.

(See HIGH FREQUENCY COMMUNICATIONS.)

HIGH FREQUENCY COMMUNICATIONS– High radio frequencies (HF) between 3 and 30 MHz used for air-to-ground voice communication in overseas operations.

HIGH SPEED EXIT–

(See HIGH SPEED TAXIWAY.)

HIGH SPEED TAXIWAY– A long radius taxiway designed and provided with lighting or marking to define the path of aircraft, traveling at high speed (up to 60 knots), from the runway center to a point on the center of a taxiway. Also referred to as long radius exit or turn-off taxiway. The high speed taxiway is designed to expedite aircraft turning off the runway after landing, thus reducing runway occupancy time.

HIGH SPEED TURNOFF–

(See HIGH SPEED TAXIWAY.)

HIWAS–

(See HAZARDOUS INFLIGHT WEATHER ADVISORY SERVICE.)

HIWAS AREA–

(See HAZARDOUS INFLIGHT WEATHER ADVISORY SERVICE.)

HIWAS BROADCAST AREA– A geographical area of responsibility including one or more HIWAS outlet areas assigned to a FSS for hazardous weather advisory broadcasting.

HIWAS OUTLET AREA– An area defined as a 150 NM radius of a HIWAS outlet, expanded as necessary to provide coverage.

HOLD FOR RELEASE– Used by ATC to delay an aircraft for traffic management reasons; i.e., weather, traffic volume, etc. Hold for release instructions (including departure delay information) are used to inform a pilot or a controller (either directly or through an authorized relay) that an IFR departure clearance is not valid until a release time or additional instructions have been received.

(See ICAO term HOLDING POINT.)

HOLD-IN-LIEU OF PROCEDURE TURN– A hold-in-lieu of procedure turn shall be established over a final or intermediate fix when an approach can be made from a properly aligned holding pattern. The hold-in-lieu of procedure turn permits the pilot to align with the final or intermediate segment of the approach and/or descend in the holding pattern to an

altitude that will permit a normal descent to the final approach fix altitude. The hold-in-lieu of procedure turn is a required maneuver (the same as a procedure turn) unless the aircraft is being radar vectored to the final approach course, when “NoPT” is shown on the approach chart, or when the pilot requests or the controller advises the pilot to make a “straight-in” approach.

HOLD PROCEDURE– A predetermined maneuver which keeps aircraft within a specified airspace while awaiting further clearance from air traffic control. Also used during ground operations to keep aircraft within a specified area or at a specified point while awaiting further clearance from air traffic control.

(See HOLDING FIX.)

(Refer to AIM.)

HOLDING FIX– A specified fix identifiable to a pilot by NAVAIDs or visual reference to the ground used as a reference point in establishing and maintaining the position of an aircraft while holding.

(See FIX.)

(See VISUAL HOLDING.)

(Refer to AIM.)

HOLDING POINT [ICAO]– A specified location, identified by visual or other means, in the vicinity of which the position of an aircraft in flight is maintained in accordance with air traffic control clearances.

HOLDING PROCEDURE–

(See HOLD PROCEDURE.)

HOLD-SHORT POINT– A point on the runway beyond which a landing aircraft with a LAHSO clearance is not authorized to proceed. This point may be located prior to an intersecting runway, taxiway, predetermined point, or approach/departure flight path.

HOLD-SHORT POSITION LIGHTS– Flashing in-pavement white lights located at specified hold-short points.

HOLD-SHORT POSITION MARKING– The painted runway marking located at the hold-short point on all LAHSO runways.

HOLD-SHORT POSITION SIGNS– Red and white holding position signs located alongside the hold-short point.

HOMING– Flight toward a NAVAID, without correcting for wind, by adjusting the aircraft heading to maintain a relative bearing of zero degrees.

(See BEARING.)

(See ICAO term HOMING.)

HOMING [ICAO]– The procedure of using the direction-finding equipment of one radio station with the emission of another radio station, where at least one of the stations is mobile, and whereby the mobile station proceeds continuously towards the other station.

HOVER CHECK– Used to describe when a helicopter/VTOL aircraft requires a stabilized hover to conduct a performance/power check prior to hover taxi, air taxi, or takeoff. Altitude of the hover will vary based on the purpose of the check.

HOVER TAXI– Used to describe a helicopter/VTOL aircraft movement conducted above the surface and in ground effect at airspeeds less than approximately 20 knots. The actual height may vary, and some helicopters may require hover taxi above 25 feet AGL to reduce ground effect turbulence or provide clearance for cargo slingloads.

(See AIR TAXI.)

(See HOVER CHECK.)

(Refer to AIM.)

HOW DO YOU HEAR ME?– A question relating to the quality of the transmission or to determine how well the transmission is being received.

HZ–

(See HERTZ.)

I

I SAY AGAIN– The message will be repeated.

IAF–

(See INITIAL APPROACH FIX.)

IAP–

(See INSTRUMENT APPROACH PROCEDURE.)

IAWP– Initial Approach Waypoint

ICAO–

(See ICAO Term INTERNATIONAL CIVIL AVIATION ORGANIZATION.)

ICAO 3LD–

(See ICAO Term ICAO Three–Letter Designator)

ICAO Three–Letter Designator (3LD)– An ICAO 3LD is an exclusive designator that, when used together with a flight number, becomes the aircraft call sign and provides distinct aircraft identification to air traffic control (ATC). ICAO approves 3LDs to enhance the safety and security of the air traffic system. An ICAO 3LD may be assigned to a company, agency, or organization and is used instead of the aircraft registration number for ATC operational and security purposes. An ICAO 3LD is also used for aircraft identification in the flight plan and associated messages and can be used for domestic and international flights. A telephony associated with an ICAO 3LD is used for radio communication.

ICING– The accumulation of airframe ice.

Types of icing are:

a. Rime Ice– Rough, milky, opaque ice formed by the instantaneous freezing of small supercooled water droplets.

b. Clear Ice– A glossy, clear, or translucent ice formed by the relatively slow freezing of large supercooled water droplets.

c. Mixed– A mixture of clear ice and rime ice.

Intensity of icing:

a. Trace– Ice becomes perceptible. Rate of accumulation is slightly greater than the rate of sublimation. Deicing/anti-icing equipment is not utilized unless encountered for an extended period of time (over 1 hour).

b. Light– The rate of accumulation may create a problem if flight is prolonged in this environment (over 1 hour). Occasional use of deicing/anti-icing equipment removes/prevents accumulation. It does not present a problem if the deicing/anti-icing equipment is used.

c. Moderate– The rate of accumulation is such that even short encounters become potentially hazardous and use of deicing/anti-icing equipment or flight diversion is necessary.

d. Severe– The rate of ice accumulation is such that ice protection systems fail to remove the accumulation of ice, or ice accumulates in locations not normally prone to icing, such as areas aft of protected surfaces and any other areas identified by the manufacturer. Immediate exit from the condition is necessary.

Note:

Severe icing is aircraft dependent, as are the other categories of icing intensity. Severe icing may occur at any ice accumulation rate.

IDENT– A request for a pilot to activate the aircraft transponder identification feature. This will help the controller to confirm an aircraft identity or to identify an aircraft.

(Refer to AIM.)

IDENT FEATURE– The special feature in the Air Traffic Control Radar Beacon System (ATCRBS) equipment. It is used to immediately distinguish one displayed beacon target from other beacon targets.

(See IDENT.)

IDENTIFICATION [ICAO]– The situation which exists when the position indication of a particular aircraft is seen on a situation display and positively identified.

IF–

(See INTERMEDIATE FIX.)

IF NO TRANSMISSION RECEIVED FOR (TIME)– Used by ATC in radar approaches to prefix procedures which should be followed by the pilot in event of lost communications.

(See LOST COMMUNICATIONS.)

IFR–

(See INSTRUMENT FLIGHT RULES.)

IFR AIRCRAFT– An aircraft conducting flight in accordance with instrument flight rules.

IFR CONDITIONS– Weather conditions below the minimum for flight under visual flight rules.

(See INSTRUMENT METEOROLOGICAL CONDITIONS.)

IFR DEPARTURE PROCEDURE–

(See IFR TAKEOFF MINIMUMS AND DEPARTURE PROCEDURES.)

(Refer to AIM.)

IFR FLIGHT–

(See IFR AIRCRAFT.)

IFR LANDING MINIMUMS–

(See LANDING MINIMUMS.)

IFR MILITARY TRAINING ROUTES (IR)– Routes used by the Department of Defense and associated Reserve and Air Guard units for the purpose of conducting low-altitude navigation and tactical training in both IFR and VFR weather conditions below 10,000 feet MSL at airspeeds in excess of 250 knots IAS.

IFR TAKEOFF MINIMUMS AND DEPARTURE PROCEDURES– Title 14 Code of Federal Regulations Part 91, prescribes standard takeoff rules for certain civil users. At some airports, obstructions or other factors require the establishment of nonstandard takeoff minimums, departure procedures, or both to assist pilots in avoiding obstacles during climb to the minimum en route altitude. Those airports are listed in FAA/DOD Instrument Approach Procedures (IAPs) Charts under a section entitled “IFR Takeoff Minimums and Departure Procedures.” The FAA/DOD IAP chart legend illustrates the symbol used to alert the pilot to nonstandard takeoff minimums and departure procedures. When departing IFR from such airports or from any airports where there are no departure procedures, DPs, or ATC facilities available, pilots should advise ATC of any departure limitations. Controllers may query a pilot to determine acceptable departure directions, turns, or headings after takeoff. Pilots should be familiar with the departure procedures and must assure that their aircraft can meet or exceed any specified climb gradients.

IF/IAWP– Intermediate Fix/Initial Approach Waypoint. The waypoint where the final approach course of a T approach meets the crossbar of the T. When

designated (in conjunction with a TAA) this waypoint will be used as an IAWP when approaching the airport from certain directions, and as an IFWP when beginning the approach from another IAWP.

IFWP– Intermediate Fix Waypoint

ILS–

(See INSTRUMENT LANDING SYSTEM.)

ILS CATEGORIES– 1. Category I. An ILS approach procedure which provides for approach to a height above touchdown of not less than 200 feet and with runway visual range of not less than 1,800 feet.– 2. Special Authorization Category I. An ILS approach procedure which provides for approach to a height above touchdown of not less than 150 feet and with runway visual range of not less than 1,400 feet, HUD to DH. 3. Category II. An ILS approach procedure which provides for approach to a height above touchdown of not less than 100 feet and with runway visual range of not less than 1,200 feet (with autoland or HUD to touchdown and noted on authorization, RVR 1,000 feet).– 4. Special Authorization Category II with Reduced Lighting. An ILS approach procedure which provides for approach to a height above touchdown of not less than 100 feet and with runway visual range of not less than 1,200 feet with autoland or HUD to touchdown and noted on authorization (no touchdown zone and centerline lighting are required).– 5. Category III:

a. IIIA.–An ILS approach procedure which provides for approach without a decision height minimum and with runway visual range of not less than 700 feet.

b. IIIB.–An ILS approach procedure which provides for approach without a decision height minimum and with runway visual range of not less than 150 feet.

c. IIIC.–An ILS approach procedure which provides for approach without a decision height minimum and without runway visual range minimum.

ILS PRM APPROACH– An instrument landing system (ILS) approach conducted to parallel runways whose extended centerlines are separated by less than 4,300 feet and at least 3,000 feet where independent closely spaced approaches are permitted. Also used in conjunction with an LDA PRM, RNAV PRM or GLS PRM approach to conduct Simultaneous Offset Instrument Approach (SOIA) operations. No Transgression Zone (NTZ) monitoring is required to

conduct these approaches. ATC utilizes an enhanced display with alerting and, with certain runway spacing, a high update rate PRM surveillance sensor. Use of a secondary monitor frequency, pilot PRM training, and publication of an Attention All Users Page are also required for all PRM approaches.

(Refer to AIM)

IM–

(See INNER MARKER.)

IMC–

(See INSTRUMENT METEOROLOGICAL CONDITIONS.)

IMMEDIATELY– Used by ATC or pilots when such action compliance is required to avoid an imminent situation.

INCERFA (Uncertainty Phase) [ICAO]– A situation wherein uncertainty exists as to the safety of an aircraft and its occupants.

INCREASED SEPARATION REQUIRED (ISR)– Indicates the confidence level of the track requires 5NM separation, 3NM separation, 1 1/2NM separation, and target resolution cannot be used.

INCREASE SPEED TO (SPEED)–

(See SPEED ADJUSTMENT.)

INERTIAL NAVIGATION SYSTEM (INS)– An RNAV system which is a form of self-contained navigation.

(See Area Navigation/RNAV.)

INFLIGHT REFUELING–

(See AERIAL REFUELING.)

INFLIGHT WEATHER ADVISORY–

(See WEATHER ADVISORY.)

INFORMATION REQUEST (INREQ)– A request originated by an FSS for information concerning an overdue VFR aircraft.

INITIAL APPROACH FIX (IAF)– The fixes depicted on instrument approach procedure charts that identify the beginning of the initial approach segment(s).

(See FIX.)

(See SEGMENTS OF AN INSTRUMENT APPROACH PROCEDURE.)

INITIAL APPROACH SEGMENT–

(See SEGMENTS OF AN INSTRUMENT APPROACH PROCEDURE.)

INITIAL APPROACH SEGMENT [ICAO]– That segment of an instrument approach procedure between the initial approach fix and the intermediate approach fix or, where applicable, the final approach fix or point.

INLAND NAVIGATION FACILITY– A navigation aid on a North American Route at which the common route and/or the noncommon route begins or ends.

INNER MARKER– A marker beacon used with an ILS (CAT II) precision approach located between the middle marker and the end of the ILS runway, transmitting a radiation pattern keyed at six dots per second and indicating to the pilot, both aurally and visually, that he/she is at the designated decision height (DH), normally 100 feet above the touchdown zone elevation, on the ILS CAT II approach. It also marks progress during a CAT III approach.

(See INSTRUMENT LANDING SYSTEM.)

(Refer to AIM.)

INNER MARKER BEACON–

(See INNER MARKER.)

INREQ–

(See INFORMATION REQUEST.)

INS–

(See INERTIAL NAVIGATION SYSTEM.)

INSTRUMENT APPROACH–

(See INSTRUMENT APPROACH PROCEDURE.)

INSTRUMENT APPROACH OPERATIONS [ICAO]– An approach and landing using instruments for navigation guidance based on an instrument approach procedure. There are two methods for executing instrument approach operations:

- a. A two-dimensional (2D) instrument approach operation, using lateral navigation guidance only; and
- b. A three-dimensional (3D) instrument approach operation, using both lateral and vertical navigation guidance.

Note: Lateral and vertical navigation guidance refers to the guidance provided either by:

- a) a ground-based radio navigation aid; or
- b) computer-generated navigation data from ground-based, space-based, self-contained navigation aids or a combination of these.

(See ICAO term INSTRUMENT APPROACH PROCEDURE.)

INSTRUMENT APPROACH PROCEDURE– A series of predetermined maneuvers for the orderly

transfer of an aircraft under instrument flight conditions from the beginning of the initial approach to a landing or to a point from which a landing may be made visually. It is prescribed and approved for a specific airport by competent authority.

(See SEGMENTS OF AN INSTRUMENT APPROACH PROCEDURE.)

(Refer to 14 CFR Part 91.)

(Refer to AIM.)

a. U.S. civil standard instrument approach procedures are approved by the FAA as prescribed under 14 CFR Part 97 and are available for public use.

b. U.S. military standard instrument approach procedures are approved and published by the Department of Defense.

c. Special instrument approach procedures are approved by the FAA for individual operators but are not published in 14 CFR Part 97 for public use.

(See ICAO term INSTRUMENT APPROACH PROCEDURE.)

INSTRUMENT APPROACH PROCEDURE [ICAO]– A series of predetermined maneuvers by reference to flight instruments with specified protection from obstacles from the initial approach fix, or where applicable, from the beginning of a defined arrival route to a point from which a landing can be completed and thereafter, if a landing is not completed, to a position at which holding or en route obstacle clearance criteria apply.

(See ICAO term INSTRUMENT APPROACH OPERATIONS)

INSTRUMENT APPROACH PROCEDURE CHARTS–

(See AERONAUTICAL CHART.)

INSTRUMENT DEPARTURE PROCEDURE (DP)– A preplanned instrument flight rule (IFR) departure procedure published for pilot use, in graphic or textual format, that provides obstruction clearance from the terminal area to the appropriate en route structure. There are two types of DP, Obstacle Departure Procedure (ODP), printed either textually or graphically, and, Standard Instrument Departure (SID), which is always printed graphically.

(See IFR TAKEOFF MINIMUMS AND DEPARTURE PROCEDURES.)

(See OBSTACLE DEPARTURE PROCEDURES.)

(See STANDARD INSTRUMENT DEPARTURES.)

(Refer to AIM.)

INSTRUMENT DEPARTURE PROCEDURE (DP) CHARTS–

(See AERONAUTICAL CHART.)

INSTRUMENT FLIGHT RULES (IFR)– Rules governing the procedures for conducting instrument flight. Also a term used by pilots and controllers to indicate type of flight plan.

(See INSTRUMENT METEOROLOGICAL CONDITIONS.)

(See VISUAL FLIGHT RULES.)

(See VISUAL METEOROLOGICAL CONDITIONS.)

(See ICAO term INSTRUMENT FLIGHT RULES.)

(Refer to AIM.)

INSTRUMENT FLIGHT RULES [ICAO]– A set of rules governing the conduct of flight under instrument meteorological conditions.

INSTRUMENT LANDING SYSTEM (ILS)– A precision instrument approach system which normally consists of the following electronic components and visual aids:

a. Localizer.

(See LOCALIZER.)

b. Glideslope.

(See GLIDESLOPE.)

c. Outer Marker.

(See OUTER MARKER.)

d. Middle Marker.

(See MIDDLE MARKER.)

e. Approach Lights.

(See AIRPORT LIGHTING.)

(Refer to 14 CFR Part 91.)

(Refer to AIM.)

INSTRUMENT METEOROLOGICAL CONDITIONS (IMC)– Meteorological conditions expressed in terms of visibility, distance from cloud, and ceiling less than the minima specified for visual meteorological conditions.

(See INSTRUMENT FLIGHT RULES.)

(See VISUAL FLIGHT RULES.)

(See VISUAL METEOROLOGICAL CONDITIONS.)

INSTRUMENT RUNWAY– A runway equipped with electronic and visual navigation aids for which a precision or nonprecision approach procedure having straight-in landing minimums has been approved.

(See ICAO term INSTRUMENT RUNWAY.)

INSTRUMENT RUNWAY [ICAO]– One of the following types of runways intended for the operation of aircraft using instrument approach procedures:

a. Nonprecision Approach Runway– An instrument runway served by visual aids and a nonvisual aid providing at least directional guidance adequate for a straight-in approach.

b. Precision Approach Runway, Category I– An instrument runway served by ILS and visual aids intended for operations down to 60 m (200 feet) decision height and down to an RVR of the order of 800 m.

c. Precision Approach Runway, Category II– An instrument runway served by ILS and visual aids intended for operations down to 30 m (100 feet) decision height and down to an RVR of the order of 400 m.

d. Precision Approach Runway, Category III– An instrument runway served by ILS to and along the surface of the runway and:

1. Intended for operations down to an RVR of the order of 200 m (no decision height being applicable) using visual aids during the final phase of landing;

2. Intended for operations down to an RVR of the order of 50 m (no decision height being applicable) using visual aids for taxiing;

3. Intended for operations without reliance on visual reference for landing or taxiing.

Note 1: See Annex 10 Volume I, Part I, Chapter 3, for related ILS specifications.

Note 2: Visual aids need not necessarily be matched to the scale of nonvisual aids provided. The criterion for the selection of visual aids is the conditions in which operations are intended to be conducted.

INTEGRITY– The ability of a system to provide timely warnings to users when the system should not be used for navigation.

INTERMEDIATE APPROACH SEGMENT–

(See SEGMENTS OF AN INSTRUMENT APPROACH PROCEDURE.)

INTERMEDIATE APPROACH SEGMENT [ICAO]– That segment of an instrument approach procedure between either the intermediate approach fix and the final approach fix or point, or between the end of a reversal, race track or dead reckoning track

procedure and the final approach fix or point, as appropriate.

INTERMEDIATE FIX– The fix that identifies the beginning of the intermediate approach segment of an instrument approach procedure. The fix is not normally identified on the instrument approach chart as an intermediate fix (IF).

(See SEGMENTS OF AN INSTRUMENT APPROACH PROCEDURE.)

INTERMEDIATE LANDING– On the rare occasion that this option is requested, it should be approved. The departure center, however, must advise the ATCSCC so that the appropriate delay is carried over and assigned at the intermediate airport. An intermediate landing airport within the arrival center will not be accepted without coordination with and the approval of the ATCSCC.

INTERNATIONAL AIRPORT– Relating to international flight, it means:

a. An airport of entry which has been designated by the Secretary of Treasury or Commissioner of Customs as an international airport for customs service.

b. A landing rights airport at which specific permission to land must be obtained from customs authorities in advance of contemplated use.

c. Airports designated under the Convention on International Civil Aviation as an airport for use by international commercial air transport and/or international general aviation.

(See ICAO term INTERNATIONAL AIRPORT.)

(Refer to Chart Supplement U.S.)

INTERNATIONAL AIRPORT [ICAO]– Any airport designated by the Contracting State in whose territory it is situated as an airport of entry and departure for international air traffic, where the formalities incident to customs, immigration, public health, animal and plant quarantine and similar procedures are carried out.

INTERNATIONAL CIVIL AVIATION ORGANIZATION [ICAO]– A specialized agency of the United Nations whose objective is to develop the principles and techniques of international air navigation and to foster planning and development of international civil air transport.

INTERROGATOR– The ground-based surveillance radar beacon transmitter-receiver, which normally scans in synchronism with a primary radar,

transmitting discrete radio signals which repetitiously request all transponders on the mode being used to reply. The replies received are mixed with the primary radar returns and displayed on the same plan position indicator (radar scope). Also, applied to the airborne element of the TACAN/DME system.

(See TRANSPONDER.)

(Refer to AIM.)

INTERSECTING RUNWAYS– Two or more runways which cross or meet within their lengths.

(See INTERSECTION.)

INTERSECTION–

a. A point defined by any combination of courses, radials, or bearings of two or more navigational aids.

b. Used to describe the point where two runways, a runway and a taxiway, or two taxiways cross or meet.

INTERSECTION DEPARTURE– A departure from any runway intersection except the end of the runway.

(See INTERSECTION.)

INTERSECTION TAKEOFF–

(See INTERSECTION DEPARTURE.)

IR–

(See IFR MILITARY TRAINING ROUTES.)

IRREGULAR SURFACE– A surface that is open for use but not per regulations.

ISR–

(See INCREASED SEPARATION REQUIRED.)

J

JAMMING– Electronic or mechanical interference which may disrupt the display of aircraft on radar or the transmission/reception of radio communications/navigation.

JET BLAST– The rapid air movement produced by exhaust from jet engines.

JET ROUTE– A route designed to serve aircraft operations from 18,000 feet MSL up to and including flight level 450. The routes are referred to as “J” routes with numbering to identify the designated route; e.g., J105.

(See Class A AIRSPACE.)

(Refer to 14 CFR Part 71.)

JET STREAM– A migrating stream of high-speed winds present at high altitudes.

JETTISONING OF EXTERNAL STORES– Airborne release of external stores; e.g., tiptanks, ordnance.

(See FUEL DUMPING.)

(Refer to 14 CFR Part 91.)

JOINT USE RESTRICTED AREA–

(See RESTRICTED AREA.)

JUMP ZONE– The airspace directly associated with a Drop Zone. Vertical and horizontal limits may be locally defined.

K

KNOWN TRAFFIC– With respect to ATC clearances, means aircraft whose altitude, position, and intentions are known to ATC.

L

LAA–

(See LOCAL AIRPORT ADVISORY.)

LAAS–

(See LOW ALTITUDE ALERT SYSTEM.)

LAHSO– An acronym for “Land and Hold Short Operation.” These operations include landing and holding short of an intersecting runway, a taxiway, a predetermined point, or an approach/departure flightpath.

LAHSO-DRY– Land and hold short operations on runways that are dry.

LAHSO-WET– Land and hold short operations on runways that are wet (but not contaminated).

LAND AND HOLD SHORT OPERATIONS– Operations which include simultaneous takeoffs and landings and/or simultaneous landings when a landing aircraft is able and is instructed by the controller to hold-short of the intersecting runway/taxiway or designated hold-short point. Pilots are expected to promptly inform the controller if the hold short clearance cannot be accepted.

(See PARALLEL RUNWAYS.)

(Refer to AIM.)

LAND-BASED AIR DEFENSE IDENTIFICATION ZONE (ADIZ)– An ADIZ over U.S. metropolitan areas, which is activated and deactivated as needed, with dimensions, activation dates, and other relevant information disseminated via NOTAM.

(See AIR DEFENSE IDENTIFICATION ZONE.)

LANDING AREA– Any locality either on land, water, or structures, including airports/heliports and intermediate landing fields, which is used, or intended to be used, for the landing and takeoff of aircraft whether or not facilities are provided for the shelter, servicing, or for receiving or discharging passengers or cargo.

(See ICAO term LANDING AREA.)

LANDING AREA [ICAO]– That part of a movement area intended for the landing or take-off of aircraft.

LANDING DIRECTION INDICATOR– A device which visually indicates the direction in which landings and takeoffs should be made.

(See TETRAHEDRON.)

(Refer to AIM.)

LANDING DISTANCE AVAILABLE (LDA)– The runway length declared available and suitable for a landing airplane.

(See ICAO term LANDING DISTANCE AVAILABLE.)

LANDING DISTANCE AVAILABLE [ICAO]– The length of runway which is declared available and suitable for the ground run of an aeroplane landing.

LANDING MINIMUMS– The minimum visibility prescribed for landing a civil aircraft while using an instrument approach procedure. The minimum applies with other limitations set forth in 14 CFR Part 91 with respect to the Minimum Descent Altitude (MDA) or Decision Height (DH) prescribed in the instrument approach procedures as follows:

a. Straight-in landing minimums. A statement of MDA and visibility, or DH and visibility, required for a straight-in landing on a specified runway, or

b. Circling minimums. A statement of MDA and visibility required for the circle-to-land maneuver.

Note: Descent below the MDA or DH must meet the conditions stated in 14 CFR Section 91.175.

(See CIRCLE-TO-LAND MANEUVER.)

(See DECISION HEIGHT.)

(See INSTRUMENT APPROACH PROCEDURE.)

(See MINIMUM DESCENT ALTITUDE.)

(See STRAIGHT-IN LANDING.)

(See VISIBILITY.)

(Refer to 14 CFR Part 91.)

LANDING ROLL– The distance from the point of touchdown to the point where the aircraft can be brought to a stop or exit the runway.

LANDING SEQUENCE– The order in which aircraft are positioned for landing.

(See APPROACH SEQUENCE.)

LAST ASSIGNED ALTITUDE– The last altitude/flight level assigned by ATC and acknowledged by the pilot.

(See MAINTAIN.)

(Refer to 14 CFR Part 91.)

LATERAL NAVIGATION (LNAV)– A function of area navigation (RNAV) equipment which calculates, displays, and provides lateral guidance to a profile or path.

LATERAL SEPARATION– The lateral spacing of aircraft at the same altitude by requiring operation on different routes or in different geographical locations.

(See SEPARATION.)

LDA–

(See LOCALIZER TYPE DIRECTIONAL AID.)

(See LANDING DISTANCE AVAILABLE.)

(See ICAO Term LANDING DISTANCE AVAILABLE.)

LF–

(See LOW FREQUENCY.)

LIGHTED AIRPORT– An airport where runway and obstruction lighting is available.

(See AIRPORT LIGHTING.)

(Refer to AIM.)

LIGHT GUN– A handheld directional light signaling device which emits a brilliant narrow beam of white, green, or red light as selected by the tower controller. The color and type of light transmitted can be used to approve or disapprove anticipated pilot actions where radio communication is not available. The light gun is used for controlling traffic operating in the vicinity of the airport and on the airport movement area.

(Refer to AIM.)

LIGHT-SPORT AIRCRAFT (LSA)– An FAA-registered aircraft, other than a helicopter or powered-lift, that meets certain weight and performance. Principally it is a single-engine aircraft with a maximum of two seats and weighing no more than 1,430 pounds if intended for operation on water, or 1,320 pounds if not. It must be of simple design (fixed landing gear (except if intended for operations on water or a glider), piston powered, nonpressurized, with a fixed or ground adjustable propeller). Performance is also limited to a maximum airspeed in level flight of not more than 120 knots calibrated airspeed (CAS), have a maximum never-exceed speed of not more than 120 knots CAS for a glider, and have a maximum stalling speed, without the use of lift-enhancing devices of not more than 45 knots CAS. It may be certificated as either Experimental LSA or as a Special LSA aircraft. A

minimum of a sport pilot certificate is required to operate light-sport aircraft.

(Refer to 14 CFR Part 1, §1.1.)

LINE UP AND WAIT (LUAW)– Used by ATC to inform a pilot to taxi onto the departure runway to line up and wait. It is not authorization for takeoff. It is used when takeoff clearance cannot immediately be issued because of traffic or other reasons.

(See CLEARED FOR TAKEOFF.)

LOCAL AIRPORT ADVISORY (LAA)– A service available only in Alaska and provided by facilities that are located on the landing airport, have a discrete ground-to-air communication frequency or the tower frequency when the tower is closed, automated weather reporting with voice broadcasting, and a continuous ASOS/AWOS data display, other continuous direct reading instruments, or manual observations available to the specialist.

(See AIRPORT ADVISORY AREA.)

LOCAL TRAFFIC– Aircraft operating in the traffic pattern or within sight of the tower, or aircraft known to be departing or arriving from flight in local practice areas, or aircraft executing practice instrument approaches at the airport.

(See TRAFFIC PATTERN.)

LOCALIZER– The component of an ILS which provides course guidance to the runway.

(See INSTRUMENT LANDING SYSTEM.)

(See ICAO term LOCALIZER COURSE.)

(Refer to AIM.)

LOCALIZER COURSE [ICAO]– The locus of points, in any given horizontal plane, at which the DDM (difference in depth of modulation) is zero.

LOCALIZER OFFSET– An angular offset of the localizer aligned within 3° of the runway alignment.

LOCALIZER TYPE DIRECTIONAL AID (LDA)– A localizer with an angular offset that exceeds 3° of the runway alignment, used for nonprecision instrument approaches with utility and accuracy comparable to a localizer, but which are not part of a complete ILS.

(Refer to AIM.)

LOCALIZER TYPE DIRECTIONAL AID (LDA) PRECISION RUNWAY MONITOR (PRM) APPROACH– An approach, which includes a glideslope, used in conjunction with an ILS PRM, RNAV PRM or GLS PRM approach to an adjacent runway to conduct Simultaneous Offset Instrument

Approaches (SOIA) to parallel runways whose centerlines are separated by less than 3,000 feet and at least 750 feet. NTZ monitoring is required to conduct these approaches.

(See SIMULTANEOUS OFFSET INSTRUMENT APPROACH (SOIA).)

(Refer to AIM.)

LOCALIZER USABLE DISTANCE– The maximum distance from the localizer transmitter at a specified altitude, as verified by flight inspection, at which reliable course information is continuously received.

(Refer to AIM.)

LOCATOR [ICAO]– An LM/MF NDB used as an aid to final approach.

Note: A locator usually has an average radius of rated coverage of between 18.5 and 46.3 km (10 and 25 NM).

LONG RANGE NAVIGATION–

(See LORAN.)

LONGITUDINAL SEPARATION– The longitudinal spacing of aircraft at the same altitude by a minimum distance expressed in units of time or miles.

(See SEPARATION.)

(Refer to AIM.)

LORAN– An electronic navigational system by which hyperbolic lines of position are determined by measuring the difference in the time of reception of synchronized pulse signals from two fixed transmitters. Loran A operates in the 1750-1950 kHz frequency band. Loran C and D operate in the 100-110 kHz frequency band. In 2010, the U.S. Coast Guard terminated all U.S. LORAN-C transmissions.

(Refer to AIM.)

LOST COMMUNICATIONS– Loss of the ability to communicate by radio. Aircraft are sometimes referred to as NORDO (No Radio). Standard pilot procedures are specified in 14 CFR Part 91. Radar controllers issue procedures for pilots to follow in the event of lost communications during a radar approach when weather reports indicate that an aircraft will likely encounter IFR weather conditions during the approach.

(Refer to 14 CFR Part 91.)

(Refer to AIM.)

LOST LINK (LL)– An interruption or loss of the control link, or when the pilot is unable to effect control of the aircraft and, as a result, the UA will perform a predictable or planned maneuver. Loss of command and control link between the Control Station and the aircraft. There are two types of links:

a. An uplink which transmits command instructions to the aircraft, and

b. A downlink which transmits the status of the aircraft and provides situational awareness to the pilot.

LOST LINK PROCEDURE– Preprogrammed or predetermined mitigations to ensure the continued safe operation of the UA in the event of a lost link (LL). In the event positive link cannot be established, flight termination must be implemented.

LOW ALTITUDE AIRWAY STRUCTURE– The network of airways serving aircraft operations up to but not including 18,000 feet MSL.

(See AIRWAY.)

(Refer to AIM.)

LOW ALTITUDE ALERT, CHECK YOUR ALTITUDE IMMEDIATELY–

(See SAFETY ALERT.)

LOW APPROACH– An approach over an airport or runway following an instrument approach or a VFR approach including the go-around maneuver where the pilot intentionally does not make contact with the runway.

(Refer to AIM.)

LOW FREQUENCY (LF)– The frequency band between 30 and 300 kHz.

(Refer to AIM.)

LOCALIZER PERFORMANCE WITH VERTICAL GUIDANCE (LPV)– A type of approach with vertical guidance (APV) based on WAAS, published on RNAV (GPS) approach charts. This procedure takes advantage of the precise lateral guidance available from WAAS. The minima is published as a decision altitude (DA).

LUAW–

(See LINE UP AND WAIT.)

M

MAA–

(See MAXIMUM AUTHORIZED ALTITUDE.)

MACH NUMBER– The ratio of true airspeed to the speed of sound; e.g., MACH .82, MACH 1.6.

(See AIRSPEED.)

MACH TECHNIQUE [ICAO]– Describes a control technique used by air traffic control whereby turbojet aircraft operating successively along suitable routes are cleared to maintain appropriate MACH numbers for a relevant portion of the en route phase of flight. The principle objective is to achieve improved utilization of the airspace and to ensure that separation between successive aircraft does not decrease below the established minima.

MAHWP– Missed Approach Holding Waypoint

MAINTAIN–

a. Concerning altitude/flight level, the term means to remain at the altitude/flight level specified. The phrase “climb and” or “descend and” normally precedes “maintain” and the altitude assignment; e.g., “descend and maintain 5,000.”

b. Concerning other ATC instructions, the term is used in its literal sense; e.g., maintain VFR.

MAINTENANCE PLANNING FRICTION LEVEL– The friction level specified in AC 150/5320-12, Measurement, Construction, and Maintenance of Skid Resistant Airport Pavement Surfaces, which represents the friction value below which the runway pavement surface remains acceptable for any category or class of aircraft operations but which is beginning to show signs of deterioration. This value will vary depending on the particular friction measurement equipment used.

MAKE SHORT APPROACH– Used by ATC to inform a pilot to alter his/her traffic pattern so as to make a short final approach.

(See TRAFFIC PATTERN.)

MAN PORTABLE AIR DEFENSE SYSTEMS (MANPADS)– MANPADS are lightweight, shoulder-launched, missile systems used to bring down aircraft and create mass casualties. The potential for MANPADS use against airborne aircraft

is real and requires familiarity with the subject. Terrorists choose MANPADS because the weapons are low cost, highly mobile, require minimal set-up time, and are easy to use and maintain. Although the weapons have limited range, and their accuracy is affected by poor visibility and adverse weather, they can be fired from anywhere on land or from boats where there is unrestricted visibility to the target.

MANDATORY ALTITUDE– An altitude depicted on an instrument Approach Procedure Chart requiring the aircraft to maintain altitude at the depicted value.

MANPADS–

(See MAN PORTABLE AIR DEFENSE SYSTEMS.)

MAP–

(See MISSED APPROACH POINT.)

MARKER BEACON– An electronic navigation facility transmitting a 75 MHz vertical fan or boneshaped radiation pattern. Marker beacons are identified by their modulation frequency and keying code, and when received by compatible airborne equipment, indicate to the pilot, both aurally and visually, that he/she is passing over the facility.

(See INNER MARKER.)

(See MIDDLE MARKER.)

(See OUTER MARKER.)

(Refer to AIM.)

MARSA–

(See MILITARY AUTHORITY ASSUMES RESPONSIBILITY FOR SEPARATION OF AIRCRAFT.)

MAWP– Missed Approach Waypoint

MAXIMUM AUTHORIZED ALTITUDE– A published altitude representing the maximum usable altitude or flight level for an airspace structure or route segment. It is the highest altitude on a Federal airway, jet route, area navigation low or high route, or other direct route for which an MEA is designated in 14 CFR Part 95 at which adequate reception of navigation aid signals is assured.

MAYDAY– The international radiotelephony distress signal. When repeated three times, it indicates

imminent and grave danger and that immediate assistance is requested.

(See PAN-PAN.)

(Refer to AIM.)

MCA–

(See MINIMUM CROSSING ALTITUDE.)

MDA–

(See MINIMUM DESCENT ALTITUDE.)

MEA–

(See MINIMUM EN ROUTE IFR ALTITUDE.)

MEARTS–

(See MICRO-EN ROUTE AUTOMATED RADAR TRACKING SYSTEM.)

METEOROLOGICAL IMPACT STATEMENT–

An unscheduled planning forecast describing conditions expected to begin within 4 to 12 hours which may impact the flow of air traffic in a specific center's (ARTCC) area.

METER FIX ARC– A semicircle, equidistant from a meter fix, usually in low altitude relatively close to the meter fix, used to help CTAS/ERAM calculate a meter time, and determine appropriate sector meter list assignments for aircraft not on an established arrival route or assigned a meter fix.

METER FIX TIME/SLOT TIME (MFT)– A calculated time to depart the meter fix in order to cross the vertex at the ACLT. This time reflects descent speed adjustment and any applicable time that must be absorbed prior to crossing the meter fix.

METER LIST–

(See ARRIVAL SECTOR ADVISORY LIST.)

METER LIST DISPLAY INTERVAL– A dynamic parameter which controls the number of minutes prior to the flight plan calculated time of arrival at the meter fix for each aircraft, at which time the TCLT is frozen and becomes an ACLT; i.e., the VTA is updated and consequently the TCLT modified as appropriate until frozen at which time updating is suspended and an ACLT is assigned. When frozen, the flight entry is inserted into the arrival sector's meter list for display on the sector PVD/MDM. MLDI is used if filed true airspeed is less than or equal to freeze speed parameters (FSPD).

METERING– A method of time-regulating arrival traffic flow into a terminal area so as not to exceed a predetermined terminal acceptance rate.

METERING AIRPORTS– Airports adapted for metering and for which optimum flight paths are defined. A maximum of 15 airports may be adapted.

METERING FIX– A fix along an established route from over which aircraft will be metered prior to entering terminal airspace. Normally, this fix should be established at a distance from the airport which will facilitate a profile descent 10,000 feet above airport elevation (AAE) or above.

METERING POSITION(S)– Adapted PVDs/MDMs and associated "D" positions eligible for display of a metering position list. A maximum of four PVDs/MDMs may be adapted.

METERING POSITION LIST– An ordered list of data on arrivals for a selected metering airport displayed on a metering position PVD/MDM.

MFT–

(See METER FIX TIME/SLOT TIME.)

MHA–

(See MINIMUM HOLDING ALTITUDE.)

MIA–

(See MINIMUM IFR ALTITUDES.)

MICROBURST– A small downburst with outbursts of damaging winds extending 2.5 miles or less. In spite of its small horizontal scale, an intense microburst could induce wind speeds as high as 150 knots

(Refer to AIM.)

MICRO-EN ROUTE AUTOMATED RADAR TRACKING SYSTEM (MEARTS)– An automated radar and radar beacon tracking system capable of employing both short-range (ASR) and long-range (ARSR) radars. This microcomputer driven system provides improved tracking, continuous data recording, and use of full digital radar displays.

MID RVR–

(See VISIBILITY.)

MIDDLE COMPASS LOCATOR–

(See COMPASS LOCATOR.)

MIDDLE MARKER– A marker beacon that defines a point along the glideslope of an ILS normally located at or near the point of decision height (ILS Category I). It is keyed to transmit alternate dots and dashes, with the alternate dots and dashes keyed at the rate of 95 dot/dash combinations per minute on a

1300 Hz tone, which is received aurally and visually by compatible airborne equipment.

(See INSTRUMENT LANDING SYSTEM.)

(See MARKER BEACON.)

(Refer to AIM.)

MILES-IN-TRAIL– A specified distance between aircraft, normally, in the same stratum associated with the same destination or route of flight.

MILITARY AUTHORITY ASSUMES RESPONSIBILITY FOR SEPARATION OF AIRCRAFT (MARS)– A condition whereby the military services involved assume responsibility for separation between participating military aircraft in the ATC system. It is used only for required IFR operations which are specified in letters of agreement or other appropriate FAA or military documents.

MILITARY LANDING ZONE– A landing strip used exclusively by the military for training. A military landing zone does not carry a runway designation.

MILITARY OPERATIONS AREA–

(See SPECIAL USE AIRSPACE.)

MILITARY TRAINING ROUTES– Airspace of defined vertical and lateral dimensions established for the conduct of military flight training at airspeeds in excess of 250 knots IAS.

(See IFR MILITARY TRAINING ROUTES.)

(See VFR MILITARY TRAINING ROUTES.)

MINIMA–

(See MINIMUMS.)

MINIMUM CROSSING ALTITUDE (MCA)– The lowest altitude at certain fixes at which an aircraft must cross when proceeding in the direction of a higher minimum en route IFR altitude (MEA).

(See MINIMUM EN ROUTE IFR ALTITUDE.)

MINIMUM DESCENT ALTITUDE (MDA)– The lowest altitude, expressed in feet above mean sea level, to which descent is authorized on final approach or during circle-to-land maneuvering in execution of a standard instrument approach procedure where no electronic glideslope is provided.

(See NONPRECISION APPROACH PROCEDURE.)

MINIMUM EN ROUTE IFR ALTITUDE (MEA)– The lowest published altitude between radio fixes

which assures acceptable navigational signal coverage and meets obstacle clearance requirements between those fixes. The MEA prescribed for a Federal airway or segment thereof, area navigation low or high route, or other direct route applies to the entire width of the airway, segment, or route between the radio fixes defining the airway, segment, or route.

(Refer to 14 CFR Part 91.)

(Refer to 14 CFR Part 95.)

(Refer to AIM.)

MINIMUM FRICTION LEVEL– The friction level specified in AC 150/5320-12, Measurement, Construction, and Maintenance of Skid Resistant Airport Pavement Surfaces, that represents the minimum recommended wet pavement surface friction value for any turbojet aircraft engaged in LAHSO. This value will vary with the particular friction measurement equipment used.

MINIMUM FUEL– Indicates that an aircraft's fuel supply has reached a state where, upon reaching the destination, it can accept little or no delay. This is not an emergency situation but merely indicates an emergency situation is possible should any undue delay occur.

(Refer to AIM.)

MINIMUM HOLDING ALTITUDE– The lowest altitude prescribed for a holding pattern which assures navigational signal coverage, communications, and meets obstacle clearance requirements.

MINIMUM IFR ALTITUDES (MIA)– Minimum altitudes for IFR operations as prescribed in 14 CFR Part 91. These altitudes are published on aeronautical charts and prescribed in 14 CFR Part 95 for airways and routes, and in 14 CFR Part 97 for standard instrument approach procedures. If no applicable minimum altitude is prescribed in 14 CFR Part 95 or 14 CFR Part 97, the following minimum IFR altitude applies:

a. In designated mountainous areas, 2,000 feet above the highest obstacle within a horizontal distance of 4 nautical miles from the course to be flown; or

b. Other than mountainous areas, 1,000 feet above the highest obstacle within a horizontal distance of 4 nautical miles from the course to be flown; or

c. As otherwise authorized by the Administrator or assigned by ATC.

(See MINIMUM CROSSING ALTITUDE.)

(See MINIMUM EN ROUTE IFR ALTITUDE.)

(See MINIMUM OBSTRUCTION CLEARANCE ALTITUDE.)

(See MINIMUM SAFE ALTITUDE.)

(See MINIMUM VECTORING ALTITUDE.)

(Refer to 14 CFR Part 91.)

MINIMUM OBSTRUCTION CLEARANCE ALTITUDE (MOCA)– The lowest published altitude in effect between radio fixes on VOR airways, off-airway routes, or route segments which meets obstacle clearance requirements for the entire route segment and which assures acceptable navigational signal coverage only within 25 statute (22 nautical) miles of a VOR.

(Refer to 14 CFR Part 91.)

(Refer to 14 CFR Part 95.)

MINIMUM RECEPTION ALTITUDE (MRA)– The lowest altitude at which an intersection can be determined.

(Refer to 14 CFR Part 95.)

MINIMUM SAFE ALTITUDE (MSA)–

a. The minimum altitude specified in 14 CFR Part 91 for various aircraft operations.

b. Altitudes depicted on approach charts which provide at least 1,000 feet of obstacle clearance for emergency use. These altitudes will be identified as Minimum Safe Altitudes or Emergency Safe Altitudes and are established as follows:

1. **Minimum Safe Altitude (MSA)**. Altitudes depicted on approach charts which provide at least 1,000 feet of obstacle clearance within a 25-mile radius of the navigation facility, waypoint, or airport reference point upon which the MSA is predicated. MSAs are for emergency use only and do not necessarily assure acceptable navigational signal coverage.

(See ICAO term Minimum Sector Altitude.)

2. **Emergency Safe Altitude (ESA)**. Altitudes depicted on approach charts which provide at least 1,000 feet of obstacle clearance in nonmountainous areas and 2,000 feet of obstacle clearance in designated mountainous areas within a 100-mile radius of the navigation facility or waypoint used as the ESA center. These altitudes are normally used only in military procedures and are identified on

published procedures as “Emergency Safe Altitudes.”

MINIMUM SAFE ALTITUDE WARNING (MSAW)– A function of the ARTS III computer that aids the controller by alerting him/her when a tracked Mode C equipped aircraft is below or is predicted by the computer to go below a predetermined minimum safe altitude.

(Refer to AIM.)

MINIMUM SECTOR ALTITUDE [ICAO]– The lowest altitude which may be used under emergency conditions which will provide a minimum clearance of 300 m (1,000 feet) above all obstacles located in an area contained within a sector of a circle of 46 km (25 NM) radius centered on a radio aid to navigation.

MINIMUMS– Weather condition requirements established for a particular operation or type of operation; e.g., IFR takeoff or landing, alternate airport for IFR flight plans, VFR flight, etc.

(See IFR CONDITIONS.)

(See IFR TAKEOFF MINIMUMS AND DEPARTURE PROCEDURES.)

(See LANDING MINIMUMS.)

(See VFR CONDITIONS.)

(Refer to 14 CFR Part 91.)

(Refer to AIM.)

MINIMUM VECTORING ALTITUDE (MVA)– The lowest MSL altitude at which an IFR aircraft will be vectored by a radar controller, except as otherwise authorized for radar approaches, departures, and missed approaches. The altitude meets IFR obstacle clearance criteria. It may be lower than the published MEA along an airway or J-route segment. It may be utilized for radar vectoring only upon the controller’s determination that an adequate radar return is being received from the aircraft being controlled. Charts depicting minimum vectoring altitudes are normally available only to the controllers and not to pilots.

(Refer to AIM.)

MINUTES-IN-TRAIL– A specified interval between aircraft expressed in time. This method would more likely be utilized regardless of altitude.

MIS–

(See METEOROLOGICAL IMPACT STATEMENT.)

MISSED APPROACH–

a. A maneuver conducted by a pilot when an instrument approach cannot be completed to a

landing. The route of flight and altitude are shown on instrument approach procedure charts. A pilot executing a missed approach prior to the Missed Approach Point (MAP) must continue along the final approach to the MAP.

b. A term used by the pilot to inform ATC that he/she is executing the missed approach.

c. At locations where ATC radar service is provided, the pilot should conform to radar vectors when provided by ATC in lieu of the published missed approach procedure.

(See MISSED APPROACH POINT.)

(Refer to AIM.)

MISSED APPROACH POINT (MAP)– A point prescribed in each instrument approach procedure at which a missed approach procedure shall be executed if the required visual reference does not exist.

(See MISSED APPROACH.)

(See SEGMENTS OF AN INSTRUMENT APPROACH PROCEDURE.)

MISSED APPROACH PROCEDURE [ICAO]– The procedure to be followed if the approach cannot be continued.

MISSED APPROACH SEGMENT–

(See SEGMENTS OF AN INSTRUMENT APPROACH PROCEDURE.)

MLDI–

(See METER LIST DISPLAY INTERVAL.)

MM–

(See MIDDLE MARKER.)

MOA–

(See MILITARY OPERATIONS AREA.)

MOCA–

(See MINIMUM OBSTRUCTION CLEARANCE ALTITUDE.)

MODE– The letter or number assigned to a specific pulse spacing of radio signals transmitted or received by ground interrogator or airborne transponder components of the Air Traffic Control Radar Beacon System (ATCRBS). Mode A (military Mode 3) and

Mode C (altitude reporting) are used in air traffic control.

(See INTERROGATOR.)

(See RADAR.)

(See TRANSPONDER.)

(See ICAO term MODE.)

(Refer to AIM.)

MODE (SSR MODE) [ICAO]– The letter or number assigned to a specific pulse spacing of the interrogation signals transmitted by an interrogator. There are 4 modes, A, B, C and D specified in Annex 10, corresponding to four different interrogation pulse spacings.

MODE C INTRUDER ALERT– A function of certain air traffic control automated systems designed to alert radar controllers to existing or pending situations between a tracked target (known IFR or VFR aircraft) and an untracked target (unknown IFR or VFR aircraft) that requires immediate attention/action.

(See CONFLICT ALERT.)

MODEL AIRCRAFT– An unmanned aircraft that is: (1) capable of sustained flight in the atmosphere; (2) flown within visual line of sight of the person operating the aircraft; and (3) flown for hobby or recreational purposes.

MONITOR– (When used with communication transfer) listen on a specific frequency and stand by for instructions. Under normal circumstances do not establish communications.

MONITOR ALERT (MA)– A function of the TFMS that provides traffic management personnel with a tool for predicting potential capacity problems in individual operational sectors. The MA is an indication that traffic management personnel need to analyze a particular sector for actual activity and to determine the required action(s), if any, needed to control the demand.

MONITOR ALERT PARAMETER (MAP)– The number designated for use in monitor alert processing by the TFMS. The MAP is designated for each operational sector for increments of 15 minutes.

MOSAIC/MULTI-SENSOR MODE– Accepts positional data from multiple radar or ADS-B sites. Targets are displayed from a single source within a radar sort box according to the hierarchy of the sources assigned.

MOUNTAIN WAVE– Mountain waves occur when air is being blown over a mountain range or even the

ridge of a sharp bluff area. As the air hits the upwind side of the range, it starts to climb, thus creating what is generally a smooth updraft which turns into a turbulent downdraft as the air passes the crest of the ridge. Mountain waves can cause significant fluctuations in airspeed and altitude with or without associated turbulence.

(Refer to AIM.)

MOVEMENT AREA– The runways, taxiways, and other areas of an airport/heliport which are utilized for taxiing/hover taxiing, air taxiing, takeoff, and landing of aircraft, exclusive of loading ramps and parking areas. At those airports/heliports with a tower, specific approval for entry onto the movement area must be obtained from ATC.

(See ICAO term MOVEMENT AREA.)

MOVEMENT AREA [ICAO]– That part of an aerodrome to be used for the takeoff, landing and taxiing of aircraft, consisting of the maneuvering area and the apron(s).

MOVING TARGET INDICATOR– An electronic device which will permit radar scope presentation only from targets which are in motion. A partial remedy for ground clutter.

MRA–

(See MINIMUM RECEPTION ALTITUDE.)

MSA–

(See MINIMUM SAFE ALTITUDE.)

MSAW–

(See MINIMUM SAFE ALTITUDE WARNING.)

MTI–

(See MOVING TARGET INDICATOR.)

MTR–

(See MILITARY TRAINING ROUTES.)

MULTICOM– A mobile service not open to public correspondence used to provide communications essential to conduct the activities being performed by or directed from private aircraft.

MULTIPLE RUNWAYS– The utilization of a dedicated arrival runway(s) for departures and a dedicated departure runway(s) for arrivals when feasible to reduce delays and enhance capacity.

MVA–

(See MINIMUM VECTORING ALTITUDE.)

N

NAS–

(See NATIONAL AIRSPACE SYSTEM.)

NAT HLA–

(See NORTH ATLANTIC HIGH LEVEL AIRSPACE.)

NATIONAL AIRSPACE SYSTEM– The common network of U.S. airspace; air navigation facilities, equipment and services, airports or landing areas; aeronautical charts, information and services; rules, regulations and procedures, technical information, and manpower and material. Included are system components shared jointly with the military.

NATIONAL BEACON CODE ALLOCATION PLAN AIRSPACE (NBCAP)– Airspace over United States territory located within the North American continent between Canada and Mexico, including adjacent territorial waters outward to about boundaries of oceanic control areas (CTA)/Flight Information Regions (FIR).

(See FLIGHT INFORMATION REGION.)

NATIONAL FLIGHT DATA CENTER (NFDC)– A facility in Washington D.C., established by FAA to operate a central aeronautical information service for the collection, validation, and dissemination of aeronautical data in support of the activities of government, industry, and the aviation community. The information is published in the National Flight Data Digest.

(See NATIONAL FLIGHT DATA DIGEST.)

NATIONAL FLIGHT DATA DIGEST (NFDD)– A daily (except weekends and Federal holidays) publication of flight information appropriate to aeronautical charts, aeronautical publications, Notices to Airmen, or other media serving the purpose of providing operational flight data essential to safe and efficient aircraft operations.

NATIONAL SEARCH AND RESCUE PLAN– An interagency agreement which provides for the effective utilization of all available facilities in all types of search and rescue missions.

NAVAID–

(See NAVIGATIONAL AID.)

NAVAID CLASSES– VOR, VORTAC, and TACAN aids are classed according to their operational use. The three classes of NAVAIDs are:

- a. T– Terminal.
- b. L– Low altitude.
- c. H– High altitude.

Note: The normal service range for T, L, and H class aids is found in the AIM. Certain operational requirements make it necessary to use some of these aids at greater service ranges than specified. Extended range is made possible through flight inspection determinations. Some aids also have lesser service range due to location, terrain, frequency protection, etc. Restrictions to service range are listed in Chart Supplement U.S.

NAVIGABLE AIRSPACE– Airspace at and above the minimum flight altitudes prescribed in the CFRs including airspace needed for safe takeoff and landing.

(Refer to 14 CFR Part 91.)

NAVIGATION REFERENCE SYSTEM (NRS)–

The NRS is a system of waypoints developed for use within the United States for flight planning and navigation without reference to ground based navigational aids. The NRS waypoints are located in a grid pattern along defined latitude and longitude lines. The initial use of the NRS will be in the high altitude environment in conjunction with the High Altitude Redesign initiative. The NRS waypoints are intended for use by aircraft capable of point-to-point navigation.

NAVIGATION SPECIFICATION [ICAO]– A set of aircraft and flight crew requirements needed to support performance-based navigation operations within a defined airspace. There are two kinds of navigation specifications:

a. **RNP specification.** A navigation specification based on area navigation that includes the requirement for performance monitoring and alerting, designated by the prefix RNP; e.g., RNP 4, RNP APCH.

b. **RNAV specification.** A navigation specification based on area navigation that does not include the requirement for performance monitoring and alert-

ing, designated by the prefix RNAV; e.g., RNAV 5, RNAV 1.

Note: The Performance-based Navigation Manual (Doc 9613), Volume II contains detailed guidance on navigation specifications.

NAVIGATIONAL AID– Any visual or electronic device airborne or on the surface which provides point-to-point guidance information or position data to aircraft in flight.

(See AIR NAVIGATION FACILITY.)

NAVSPEC–

(See NAVIGATION SPECIFICATION [ICAO].)

NBCAP AIRSPACE–

(See NATIONAL BEACON CODE ALLOCATION PLAN AIRSPACE.)

NDB–

(See NONDIRECTIONAL BEACON.)

NEGATIVE– “No,” or “permission not granted,” or “that is not correct.”

NEGATIVE CONTACT– Used by pilots to inform ATC that:

a. Previously issued traffic is not in sight. It may be followed by the pilot’s request for the controller to provide assistance in avoiding the traffic.

b. They were unable to contact ATC on a particular frequency.

NFDC–

(See NATIONAL FLIGHT DATA CENTER.)

NFDD–

(See NATIONAL FLIGHT DATA DIGEST.)

NIGHT– The time between the end of evening civil twilight and the beginning of morning civil twilight, as published in the Air Almanac, converted to local time.

(See ICAO term NIGHT.)

NIGHT [ICAO]– The hours between the end of evening civil twilight and the beginning of morning civil twilight or such other period between sunset and sunrise as may be specified by the appropriate authority.

Note: Civil twilight ends in the evening when the center of the sun’s disk is 6 degrees below the horizon and begins in the morning when the center of the sun’s disk is 6 degrees below the horizon.

NO GYRO APPROACH– A radar approach/vector provided in case of a malfunctioning gyro-compass or directional gyro. Instead of providing the pilot with headings to be flown, the controller observes the radar track and issues control instructions “turn right/left” or “stop turn” as appropriate.

(Refer to AIM.)

NO GYRO VECTOR–

(See NO GYRO APPROACH.)

NO TRANSGRESSION ZONE (NTZ)– The NTZ is a 2,000 foot wide zone, located equidistant between parallel runway or SOIA final approach courses, in which flight is normally not allowed.

NONAPPROACH CONTROL TOWER– Authorizes aircraft to land or takeoff at the airport controlled by the tower or to transit the Class D airspace. The primary function of a nonapproach control tower is the sequencing of aircraft in the traffic pattern and on the landing area. Nonapproach control towers also separate aircraft operating under instrument flight rules clearances from approach controls and centers. They provide ground control services to aircraft, vehicles, personnel, and equipment on the airport movement area.

NONCOMMON ROUTE/PORTION– That segment of a North American Route between the inland navigation facility and a designated North American terminal.

NONDIRECTIONAL BEACON– An L/MF or UHF radio beacon transmitting nondirectional signals whereby the pilot of an aircraft equipped with direction finding equipment can determine his/her bearing to or from the radio beacon and “home” on or track to or from the station. When the radio beacon is installed in conjunction with the Instrument Landing System marker, it is normally called a Compass Locator.

(See AUTOMATIC DIRECTION FINDER.)

(See COMPASS LOCATOR.)

NONMOVEMENT AREAS– Taxiways and apron (ramp) areas not under the control of air traffic.

NONPRECISION APPROACH–

(See NONPRECISION APPROACH PROCEDURE.)

NONPRECISION APPROACH PROCEDURE– A standard instrument approach procedure in which no electronic glideslope is provided; e.g., VOR, TACAN, NDB, LOC, ASR, LDA, or SDF approaches.

NONRADAR– Precedes other terms and generally means without the use of radar, such as:

a. Nonradar Approach. Used to describe instrument approaches for which course guidance on final approach is not provided by ground-based precision or surveillance radar. Radar vectors to the final approach course may or may not be provided by ATC. Examples of nonradar approaches are VOR, NDB, TACAN, ILS, RNAV, and GLS approaches.

(See FINAL APPROACH COURSE.)

(See FINAL APPROACH-IFR.)

(See INSTRUMENT APPROACH PROCEDURE.)

(See RADAR APPROACH.)

b. Nonradar Approach Control. An ATC facility providing approach control service without the use of radar.

(See APPROACH CONTROL FACILITY.)

(See APPROACH CONTROL SERVICE.)

c. Nonradar Arrival. An aircraft arriving at an airport without radar service or at an airport served by a radar facility and radar contact has not been established or has been terminated due to a lack of radar service to the airport.

(See RADAR ARRIVAL.)

(See RADAR SERVICE.)

d. Nonradar Route. A flight path or route over which the pilot is performing his/her own navigation. The pilot may be receiving radar separation, radar monitoring, or other ATC services while on a nonradar route.

(See RADAR ROUTE.)

e. Nonradar Separation. The spacing of aircraft in accordance with established minima without the use of radar; e.g., vertical, lateral, or longitudinal separation.

(See RADAR SEPARATION.)

NON-RESTRICTIVE ROUTING (NRR)– Portions of a proposed route of flight where a user can flight plan the most advantageous flight path with no requirement to make reference to ground-based NAVAIDs.

NOPAC–

(See NORTH PACIFIC.)

NORDO (No Radio)– Aircraft that cannot or do not communicate by radio when radio communication is required are referred to as “NORDO.”

(See LOST COMMUNICATIONS.)

NORMAL OPERATING ZONE (NOZ)– The NOZ is the operating zone within which aircraft flight remains during normal independent simultaneous parallel ILS approaches.

NORTH AMERICAN ROUTE– A numerically coded route preplanned over existing airway and route systems to and from specific coastal fixes serving the North Atlantic. North American Routes consist of the following:

a. Common Route/Portion. That segment of a North American Route between the inland navigation facility and the coastal fix.

b. Noncommon Route/Portion. That segment of a North American Route between the inland navigation facility and a designated North American terminal.

c. Inland Navigation Facility. A navigation aid on a North American Route at which the common route and/or the noncommon route begins or ends.

d. Coastal Fix. A navigation aid or intersection where an aircraft transitions between the domestic route structure and the oceanic route structure.

NORTH AMERICAN ROUTE PROGRAM (NRP)– The NRP is a set of rules and procedures which are designed to increase the flexibility of user flight planning within published guidelines.

NORTH ATLANTIC HIGH LEVEL AIRSPACE (NAT HLA)– That volume of airspace (as defined in ICAO Document 7030) between FL 285 and FL 420 within the Oceanic Control Areas of Bodo Oceanic, Gander Oceanic, New York Oceanic East, Reykjavik, Santa Maria, and Shanwick, excluding the Shannon and Brest Ocean Transition Areas. ICAO Doc 007 *North Atlantic Operations and Airspace Manual* provides detailed information on related aircraft and operational requirements.

NORTH MARK– A beacon data block sent by the host computer to be displayed by the ARTS on a 360 degree bearing at a locally selected radar azimuth and distance. The North Mark is used to ensure correct range/azimuth orientation during periods of CENRAP.

NORTH PACIFIC– An organized route system between the Alaskan west coast and Japan.

NOT STANDARD– Varying from what is expected or published. For use in NOTAMs only.

NOT STD-

(See NOT STANDARD.)

NOTAM–

(See NOTICE TO AIRMEN.)

NOTAM [ICAO]– A notice containing information concerning the establishment, condition or change in any aeronautical facility, service, procedure or hazard, the timely knowledge of which is essential to personnel concerned with flight operations.

a. I Distribution– Distribution by means of telecommunication.

b. II Distribution– Distribution by means other than telecommunications.

NOTICE TO AIRMEN (NOTAM)– A notice containing information (not known sufficiently in advance to publicize by other means) concerning the establishment, condition, or change in any component (facility, service, or procedure of, or hazard in the National Airspace System) the timely knowledge of which is essential to personnel concerned with flight operations.

NOTAM(D)– A NOTAM given (in addition to local dissemination) distant dissemination beyond the area

of responsibility of the Flight Service Station. These NOTAMs will be stored and available until canceled.

c. FDC NOTAM– A NOTAM regulatory in nature, transmitted by USNOF and given system wide dissemination.

(See ICAO term NOTAM.)

NOTICES TO AIRMEN PUBLICATION– A publication issued every 28 days, designed primarily for the pilot, which contains NOTAMs, graphic notices, and other information considered essential to the safety of flight as well as supplemental data to other aeronautical publications. The contraction NTAP is used in NOTAM text.

(See NOTICE TO AIRMEN.)

NRR–

(See NON-RESTRICTIVE ROUTING.)

NRS–

(See NAVIGATION REFERENCE SYSTEM.)

NTAP–

(See NOTICES TO AIRMEN PUBLICATION.)

NUMEROUS TARGETS VICINITY (LOCATION)– A traffic advisory issued by ATC to advise pilots that targets on the radar scope are too numerous to issue individually.

(See TRAFFIC ADVISORIES.)

O

OBSTACLE– An existing object, object of natural growth, or terrain at a fixed geographical location or which may be expected at a fixed location within a prescribed area with reference to which vertical clearance is or must be provided during flight operation.

OBSTACLE DEPARTURE PROCEDURE (ODP)– A preplanned instrument flight rule (IFR) departure procedure printed for pilot use in textual or graphic form to provide obstruction clearance via the least onerous route from the terminal area to the appropriate en route structure. ODPs are recommended for obstruction clearance and may be flown without ATC clearance unless an alternate departure procedure (SID or radar vector) has been specifically assigned by ATC.

(See IFR TAKEOFF MINIMUMS AND DEPARTURE PROCEDURES.)

(See STANDARD INSTRUMENT DEPARTURES.)

(Refer to AIM.)

OBSTACLE FREE ZONE– The OFZ is a three-dimensional volume of airspace which protects for the transition of aircraft to and from the runway. The OFZ clearing standard precludes taxiing and parked airplanes and object penetrations, except for frangible NAVAID locations that are fixed by function. Additionally, vehicles, equipment, and personnel may be authorized by air traffic control to enter the area using the provisions of FAA Order JO 7110.65, Paragraph 3–1–5, Vehicles/Equipment/Personnel Near/On Runways. The runway OFZ and when applicable, the inner-approach OFZ, and the inner-transitional OFZ, comprise the OFZ.

a. Runway OFZ. The runway OFZ is a defined volume of airspace centered above the runway. The runway OFZ is the airspace above a surface whose elevation at any point is the same as the elevation of the nearest point on the runway centerline. The runway OFZ extends 200 feet beyond each end of the runway. The width is as follows:

1. For runways serving large airplanes, the greater of:

(a) 400 feet, or

(b) 180 feet, plus the wingspan of the most demanding airplane, plus 20 feet per 1,000 feet of airport elevation.

2. For runways serving only small airplanes:

(a) 300 feet for precision instrument runways.

(b) 250 feet for other runways serving small airplanes with approach speeds of 50 knots, or more.

(c) 120 feet for other runways serving small airplanes with approach speeds of less than 50 knots.

b. Inner-approach OFZ. The inner-approach OFZ is a defined volume of airspace centered on the approach area. The inner-approach OFZ applies only to runways with an approach lighting system. The inner-approach OFZ begins 200 feet from the runway threshold at the same elevation as the runway threshold and extends 200 feet beyond the last light unit in the approach lighting system. The width of the inner-approach OFZ is the same as the runway OFZ and rises at a slope of 50 (horizontal) to 1 (vertical) from the beginning.

c. Inner-transitional OFZ. The inner transitional surface OFZ is a defined volume of airspace along the sides of the runway and inner-approach OFZ and applies only to precision instrument runways. The inner-transitional surface OFZ slopes 3 (horizontal) to 1 (vertical) out from the edges of the runway OFZ and inner-approach OFZ to a height of 150 feet above the established airport elevation.

(Refer to AC 150/5300-13, Chapter 3.)

(Refer to FAA Order JO 7110.65, Para 3–1–5, Vehicles/Equipment/Personnel Near/On Runways.)

OBSTRUCTION– Any object/obstacle exceeding the obstruction standards specified by 14 CFR Part 77, Subpart C.

OBSTRUCTION LIGHT– A light or one of a group of lights, usually red or white, frequently mounted on a surface structure or natural terrain to warn pilots of the presence of an obstruction.

OCEANIC AIRSPACE– Airspace over the oceans of the world, considered international airspace, where oceanic separation and procedures per the International Civil Aviation Organization are applied. Responsibility for the provisions of air traffic control

service in this airspace is delegated to various countries, based generally upon geographic proximity and the availability of the required resources.

OCEANIC ERROR REPORT– A report filed when ATC observes an Oceanic Error as defined by FAA Order 7110.82, Reporting Oceanic Errors.

OCEANIC PUBLISHED ROUTE– A route established in international airspace and charted or described in flight information publications, such as Route Charts, DOD En route Charts, Chart Supplements, NOTAMs, and Track Messages.

OCEANIC TRANSITION ROUTE– An ATS route established for the purpose of transitioning aircraft to/from an organized track system.

ODP–

(See OBSTACLE DEPARTURE PROCEDURE.)

OFF COURSE– A term used to describe a situation where an aircraft has reported a position fix or is observed on radar at a point not on the ATC-approved route of flight.

OFF-ROUTE VECTOR– A vector by ATC which takes an aircraft off a previously assigned route. Altitudes assigned by ATC during such vectors provide required obstacle clearance.

OFFSET PARALLEL RUNWAYS– Staggered runways having centerlines which are parallel.

OFFSHORE/CONTROL AIRSPACE AREA– That portion of airspace between the U.S. 12 NM limit and the oceanic CTA/FIR boundary within which air traffic control is exercised. These areas are established to provide air traffic control services. Offshore/Control Airspace Areas may be classified as either Class A airspace or Class E airspace.

OFT–

(See OUTER FIX TIME.)

OM–

(See OUTER MARKER.)

ON COURSE–

a. Used to indicate that an aircraft is established on the route centerline.

b. Used by ATC to advise a pilot making a radar approach that his/her aircraft is lined up on the final approach course.

(See ON-COURSE INDICATION.)

ON-COURSE INDICATION– An indication on an instrument, which provides the pilot a visual means of determining that the aircraft is located on the centerline of a given navigational track, or an indication on a radar scope that an aircraft is on a given track.

ONE-MINUTE WEATHER– The most recent one minute updated weather broadcast received by a pilot from an uncontrolled airport ASOS/AWOS.

ONER–

(See OCEANIC NAVIGATIONAL ERROR REPORT.)

OPERATIONAL–

(See DUE REGARD.)

OPERATIONS SPECIFICATIONS [ICAO]– The authorizations, conditions and limitations associated with the air operator certificate and subject to the conditions in the operations manual.

OPPOSITE DIRECTION AIRCRAFT– Aircraft are operating in opposite directions when:

a. They are following the same track in reciprocal directions; or

b. Their tracks are parallel and the aircraft are flying in reciprocal directions; or

c. Their tracks intersect at an angle of more than 135°.

OPTION APPROACH– An approach requested and conducted by a pilot which will result in either a touch-and-go, missed approach, low approach, stop-and-go, or full stop landing. Pilots should advise ATC if they decide to remain on the runway, of any delay in their stop and go, delay clearing the runway, or are unable to comply with the instruction(s).

(See CLEARED FOR THE OPTION.)

(Refer to AIM.)

ORGANIZED TRACK SYSTEM– A series of ATS routes which are fixed and charted; i.e., CEP, NOPAC, or flexible and described by NOTAM; i.e., NAT TRACK MESSAGE.

OFF-ROUTE OBSTRUCTION CLEARANCE ALTITUDE (OROCA)– An off-route altitude which provides obstruction clearance with a 1,000 foot buffer in non-mountainous terrain areas and a 2,000 foot buffer in designated mountainous areas within the United States. This altitude may not provide signal coverage from ground-based navigational aids, air traffic control radar, or communications coverage.

OTR–

(See OCEANIC TRANSITION ROUTE.)

OTS–

(See ORGANIZED TRACK SYSTEM.)

OUT– The conversation is ended and no response is expected.

OUT OF SERVICE– When a piece of equipment, a system, a facility or a service is not operational, certified (if required) and immediately “available” for Air Traffic or public use.

OUTER AREA (associated with Class C airspace)– Non-regulatory airspace surrounding designated Class C airspace airports wherein ATC provides radar vectoring and sequencing on a full-time basis for all IFR and participating VFR aircraft. The service provided in the outer area is called Class C service which includes: IFR/IFR-IFR separation; IFR/VFR-traffic advisories and conflict resolution; and VFR/VFR-traffic advisories and, as appropriate, safety alerts. The normal radius will be 20 nautical miles with some variations based on site-specific requirements. The outer area extends outward from the primary Class C airspace airport and extends from the lower limits of radar/radio coverage up to the ceiling of the approach control’s delegated airspace excluding the Class C charted area and other airspace as appropriate.

(See CONFLICT RESOLUTION.)

(See CONTROLLED AIRSPACE.)

OUTER COMPASS LOCATOR–

(See COMPASS LOCATOR.)

OUTER FIX– A general term used within ATC to describe fixes in the terminal area, other than the final approach fix. Aircraft are normally cleared to these fixes by an Air Route Traffic Control Center or an Approach Control Facility. Aircraft are normally cleared from these fixes to the final approach fix or final approach course.

OR

OUTER FIX– An adapted fix along the converted route of flight, prior to the meter fix, for which crossing times are calculated and displayed in the metering position list.

OUTER FIX ARC– A semicircle, usually about a 50–70 mile radius from a meter fix, usually in high altitude, which is used by CTAS/ERAM to calculate outer fix times and determine appropriate sector meter list assignments for aircraft on an established arrival route that will traverse the arc.

OUTER FIX TIME– A calculated time to depart the outer fix in order to cross the vertex at the ACLT. The time reflects descent speed adjustments and any applicable delay time that must be absorbed prior to crossing the meter fix.

OUTER MARKER– A marker beacon at or near the glideslope intercept altitude of an ILS approach. It is keyed to transmit two dashes per second on a 400 Hz tone, which is received aurally and visually by compatible airborne equipment. The OM is normally located four to seven miles from the runway threshold on the extended centerline of the runway.

(See INSTRUMENT LANDING SYSTEM.)

(See MARKER BEACON.)

(Refer to AIM.)

OVER– My transmission is ended; I expect a response.

OVERHEAD MANEUVER– A series of predetermined maneuvers prescribed for aircraft (often in formation) for entry into the visual flight rules (VFR) traffic pattern and to proceed to a landing. An overhead maneuver is not an instrument flight rules (IFR) approach procedure. An aircraft executing an overhead maneuver is considered VFR and the IFR flight plan is canceled when the aircraft reaches the “initial point” on the initial approach portion of the maneuver. The pattern usually specifies the following:

- a. The radio contact required of the pilot.
- b. The speed to be maintained.
- c. An initial approach 3 to 5 miles in length.
- d. An elliptical pattern consisting of two 180 degree turns.
- e. A break point at which the first 180 degree turn is started.
- f. The direction of turns.

g. Altitude (at least 500 feet above the conventional pattern).

h. A “Roll-out” on final approach not less than 1/4 mile from the landing threshold and not less than 300 feet above the ground.

OVERLYING CENTER– The ARTCC facility that is responsible for arrival/departure operations at a specific terminal.

P

P TIME–

(See PROPOSED DEPARTURE TIME.)

P-ACP–

(See PREARRANGED COORDINATION PROCEDURES.)

PAN-PAN– The international radio-telephony urgency signal. When repeated three times, indicates uncertainty or alert followed by the nature of the urgency.

(See MAYDAY.)

(Refer to AIM.)

PAR–

(See PRECISION APPROACH RADAR.)

PAR [ICAO]–

(See ICAO Term PRECISION APPROACH RADAR.)

PARALLEL ILS APPROACHES– Approaches to parallel runways by IFR aircraft which, when established inbound toward the airport on the adjacent final approach courses, are radar-separated by at least 2 miles.

(See FINAL APPROACH COURSE.)

(See SIMULTANEOUS ILS APPROACHES.)

PARALLEL OFFSET ROUTE– A parallel track to the left or right of the designated or established airway/route. Normally associated with Area Navigation (RNAV) operations.

(See AREA NAVIGATION.)

PARALLEL RUNWAYS– Two or more runways at the same airport whose centerlines are parallel. In addition to runway number, parallel runways are designated as L (left) and R (right) or, if three parallel runways exist, L (left), C (center), and R (right).

PBCT–

(See PROPOSED BOUNDARY CROSSING TIME.)

PBN–

(See ICAO Term PERFORMANCE–BASED NAVIGATION.)

PDC–

(See PRE–DEPARTURE CLEARANCE.)

PERFORMANCE–BASED NAVIGATION (PBN) [ICAO]– Area navigation based on performance requirements for aircraft operating along an ATS route, on an instrument approach procedure or in a designated airspace.

Note: Performance requirements are expressed in navigation specifications (RNAV specification, RNP specification) in terms of accuracy, integrity, continuity, availability, and functionality needed for the proposed operation in the context of a particular airspace concept.

PERMANENT ECHO– Radar signals reflected from fixed objects on the earth's surface; e.g., buildings, towers, terrain. Permanent echoes are distinguished from “ground clutter” by being definable locations rather than large areas. Under certain conditions they may be used to check radar alignment.

PHOTO RECONNAISSANCE– Military activity that requires locating individual photo targets and navigating to the targets at a preplanned angle and altitude. The activity normally requires a lateral route width of 16 NM and altitude range of 1,500 feet to 10,000 feet AGL.

PILOT BRIEFING– A service provided by the FSS to assist pilots in flight planning. Briefing items may include weather information, NOTAMS, military activities, flow control information, and other items as requested.

(Refer to AIM.)

PILOT IN COMMAND– The pilot responsible for the operation and safety of an aircraft during flight time.

(Refer to 14 CFR Part 91.)

PILOT WEATHER REPORT– A report of meteorological phenomena encountered by aircraft in flight.

(Refer to AIM.)

PILOT'S DISCRETION– When used in conjunction with altitude assignments, means that ATC has offered the pilot the option of starting climb or descent whenever he/she wishes and conducting the climb or descent at any rate he/she wishes. He/she may temporarily level off at any intermediate altitude. However, once he/she has vacated an altitude, he/she may not return to that altitude.

PIREP–

(See PILOT WEATHER REPORT.)

PITCH POINT– A fix/waypoint that serves as a transition point from a departure procedure or the low altitude ground-based navigation structure into the high altitude waypoint system.

PLANS DISPLAY– A display available in EDST that provides detailed flight plan and predicted conflict information in textual format for requested Current Plans and all Trial Plans.

(See EN ROUTE DECISION SUPPORT TOOL)

POFZ–

(See PRECISION OBSTACLE FREE ZONE.)

POINT OUT–

(See RADAR POINT OUT.)

POINT-TO-POINT (PTP)– A level of NRR service for aircraft that is based on traditional waypoints in their FMSs or RNAV equipage.

POLAR TRACK STRUCTURE– A system of organized routes between Iceland and Alaska which overlie Canadian MNPS Airspace.

POSITION REPORT– A report over a known location as transmitted by an aircraft to ATC.

(Refer to AIM.)

POSITION SYMBOL– A computer-generated indication shown on a radar display to indicate the mode of tracking.

POSITIVE CONTROL– The separation of all air traffic within designated airspace by air traffic control.

PRACTICE INSTRUMENT APPROACH– An instrument approach procedure conducted by a VFR or an IFR aircraft for the purpose of pilot training or proficiency demonstrations.

PRE-DEPARTURE CLEARANCE– An application with the Terminal Data Link System (TDLS) that provides clearance information to subscribers, through a service provider, in text to the cockpit or gate printer.

PREARRANGED COORDINATION– A standardized procedure which permits an air traffic controller to enter the airspace assigned to another air traffic controller without verbal coordination. The procedures are defined in a facility directive which ensures approved separation between aircraft.

PREARRANGED COORDINATION PROCEDURES– A facility's standardized procedure that describes the process by which one controller shall allow an aircraft to penetrate or transit another controller's airspace in a manner that assures approved separation without individual coordination for each aircraft.

PRECIPITATION– Any or all forms of water particles (rain, sleet, hail, or snow) that fall from the atmosphere and reach the surface.

PRECIPITATION RADAR WEATHER DESCRIPTIONS– Existing radar systems cannot detect turbulence. However, there is a direct correlation between the degree of turbulence and other weather features associated with thunderstorms and the weather radar precipitation intensity. Controllers will issue (where capable) precipitation intensity as observed by radar when using weather and radar processor (WARP) or NAS ground-based digital radars with weather capabilities. When precipitation intensity information is not available, the intensity will be described as UNKNOWN. When intensity levels can be determined, they shall be described as:

- a. LIGHT (< 26 dBZ)
- b. MODERATE (26 to 40 dBZ)
- c. HEAVY (> 40 to 50 dBZ)
- d. EXTREME (> 50 dBZ)

(Refer to AC 00-45, Aviation Weather Services.)

PRECISION APPROACH–

(See PRECISION APPROACH PROCEDURE.)

PRECISION APPROACH PROCEDURE– A standard instrument approach procedure in which an electronic glideslope or other type of glidepath is provided; e.g., ILS, PAR, and GLS.

(See INSTRUMENT LANDING SYSTEM.)

(See PRECISION APPROACH RADAR.)

PRECISION APPROACH RADAR– Radar equipment in some ATC facilities operated by the FAA and/or the military services at joint-use civil/military locations and separate military installations to detect and display azimuth, elevation, and range of aircraft on the final approach course to a runway. This equipment may be used to monitor certain non-radar approaches, but is primarily used to conduct a precision instrument approach (PAR) wherein the controller issues guidance instructions to the pilot based on the aircraft's position in relation to the final approach course (azimuth), the glidepath (elevation), and the distance (range) from the touchdown point on the runway as displayed on the radar scope.

Note: The abbreviation "PAR" is also used to denote preferential arrival routes in ARTCC computers.

(See GLIDEPATH.)

(See PAR.)

(See PREFERENTIAL ROUTES.)

(See ICAO term PRECISION APPROACH RADAR.)

(Refer to AIM.)

PRECISION APPROACH RADAR [ICAO]– Primary radar equipment used to determine the position of an aircraft during final approach, in terms of lateral and vertical deviations relative to a nominal approach path, and in range relative to touchdown.

Note: Precision approach radars are designed to enable pilots of aircraft to be given guidance by radio communication during the final stages of the approach to land.

PRECISION OBSTACLE FREE ZONE (POFZ)– An 800 foot wide by 200 foot long area centered on the runway centerline adjacent to the threshold designed to protect aircraft flying precision approaches from ground vehicles and other aircraft when ceiling is less than 250 feet or visibility is less than 3/4 statute mile (or runway visual range below 4,000 feet.)

PRECISION RUNWAY MONITOR (PRM) SYSTEM– Provides air traffic controllers monitoring the NTZ during simultaneous close parallel PRM approaches with precision, high update rate secondary surveillance data. The high update rate surveillance sensor component of the PRM system is only required for specific runway or approach course separation. The high resolution color monitoring display, Final Monitor Aid (FMA) of the PRM

system, or other FMA with the same capability, presents NTZ surveillance track data to controllers along with detailed maps depicting approaches and no transgression zone and is required for all simultaneous close parallel PRM NTZ monitoring operations.

(Refer to AIM)

PREDICTIVE WIND SHEAR ALERT SYSTEM (PWS)– A self-contained system used on board some aircraft to alert the flight crew to the presence of a potential wind shear. PWS systems typically monitor 3 miles ahead and 25 degrees left and right of the aircraft's heading at or below 1200' AGL. Departing flights may receive a wind shear alert after they start the takeoff roll and may elect to abort the takeoff. Aircraft on approach receiving an alert may elect to go around or perform a wind shear escape maneuver.

PREFERENTIAL ROUTES– Preferential routes (PDRs, PARs, and PDARs) are adapted in ARTCC computers to accomplish inter/intrafacility controller coordination and to assure that flight data is posted at the proper control positions. Locations having a need for these specific inbound and outbound routes normally publish such routes in local facility bulletins, and their use by pilots minimizes flight plan route amendments. When the workload or traffic situation permits, controllers normally provide radar vectors or assign requested routes to minimize circuitous routing. Preferential routes are usually confined to one ARTCC's area and are referred to by the following names or acronyms:

a. Preferential Departure Route (PDR). A specific departure route from an airport or terminal area to an en route point where there is no further need for flow control. It may be included in an Instrument Departure Procedure (DP) or a Preferred IFR Route.

b. Preferential Arrival Route (PAR). A specific arrival route from an appropriate en route point to an airport or terminal area. It may be included in a Standard Terminal Arrival (STAR) or a Preferred IFR Route. The abbreviation "PAR" is used primarily within the ARTCC and should not be confused with the abbreviation for Precision Approach Radar.

c. Preferential Departure and Arrival Route (PDAR). A route between two terminals which are within or immediately adjacent to one ARTCC's area. PDARs are not synonymous with Preferred IFR Routes but may be listed as such as they do accomplish essentially the same purpose.

(See PREFERRED IFR ROUTES.)

PREFERRED IFR ROUTES– Routes established between busier airports to increase system efficiency and capacity. They normally extend through one or more ARTCC areas and are designed to achieve balanced traffic flows among high density terminals. IFR clearances are issued on the basis of these routes except when severe weather avoidance procedures or other factors dictate otherwise. Preferred IFR Routes are listed in the Chart Supplement U.S. If a flight is planned to or from an area having such routes but the departure or arrival point is not listed in the Chart Supplement U.S., pilots may use that part of a Preferred IFR Route which is appropriate for the departure or arrival point that is listed. Preferred IFR Routes are correlated with DPs and STARs and may be defined by airways, jet routes, direct routes between NAVAIDs, Waypoints, NAVAID radials/DME, or any combinations thereof.

(See CENTER'S AREA.)

(See INSTRUMENT DEPARTURE PROCEDURE.)

(See PREFERENTIAL ROUTES.)

(See STANDARD TERMINAL ARRIVAL.)

(Refer to CHART SUPPLEMENT U.S.)

(Refer to NOTICES TO AIRMEN PUBLICATION.)

PRE-FLIGHT PILOT BRIEFING–

(See PILOT BRIEFING.)

PREVAILING VISIBILITY–

(See VISIBILITY.)

PRIMARY RADAR TARGET– An analog or digital target, exclusive of a secondary radar target, presented on a radar display.

PRM–

(See ILS PRM APPROACH and PRECISION RUNWAY MONITOR SYSTEM.)

PROCEDURAL CONTROL [ICAO]– Term used to indicate that information derived from an ATS surveillance system is not required for the provision of air traffic control service.

PROCEDURAL SEPARATION [ICAO]– The separation used when providing procedural control.

PROCEDURE TURN– The maneuver prescribed when it is necessary to reverse direction to establish an aircraft on the intermediate approach segment or final approach course. The outbound course, direction of turn, distance within which the turn must be completed, and minimum altitude are specified in

the procedure. However, unless otherwise restricted, the point at which the turn may be commenced and the type and rate of turn are left to the discretion of the pilot.

(See ICAO term PROCEDURE TURN.)

PROCEDURE TURN [ICAO]– A maneuver in which a turn is made away from a designated track followed by a turn in the opposite direction to permit the aircraft to intercept and proceed along the reciprocal of the designated track.

Note 1: Procedure turns are designated “left” or “right” according to the direction of the initial turn.

Note 2: Procedure turns may be designated as being made either in level flight or while descending, according to the circumstances of each individual approach procedure.

PROCEDURE TURN INBOUND– That point of a procedure turn maneuver where course reversal has been completed and an aircraft is established inbound on the intermediate approach segment or final approach course. A report of “procedure turn inbound” is normally used by ATC as a position report for separation purposes.

(See FINAL APPROACH COURSE.)

(See PROCEDURE TURN.)

(See SEGMENTS OF AN INSTRUMENT APPROACH PROCEDURE.)

PROFILE DESCENT– An uninterrupted descent (except where level flight is required for speed adjustment; e.g., 250 knots at 10,000 feet MSL) from cruising altitude/level to interception of a glideslope or to a minimum altitude specified for the initial or intermediate approach segment of a nonprecision instrument approach. The profile descent normally terminates at the approach gate or where the glideslope or other appropriate minimum altitude is intercepted.

PROGRESS REPORT–

(See POSITION REPORT.)

PROGRESSIVE TAXI– Precise taxi instructions given to a pilot unfamiliar with the airport or issued in stages as the aircraft proceeds along the taxi route.

PROHIBITED AREA–

(See SPECIAL USE AIRSPACE.)

(See ICAO term PROHIBITED AREA.)

PROHIBITED AREA [ICAO]– An airspace of defined dimensions, above the land areas or territorial waters of a State, within which the flight of aircraft is prohibited.

PROMINENT OBSTACLE– An obstacle that meets one or more of the following conditions:

a. An obstacle which stands out beyond the adjacent surface of surrounding terrain and immediately projects a noticeable hazard to aircraft in flight.

b. An obstacle, not characterized as low and close in, whose height is no less than 300 feet above the departure end of takeoff runway (DER) elevation, is within 10NM from the DER, and that penetrates that airport/heliport's diverse departure obstacle clearance surface (OCS).

c. An obstacle beyond 10NM from an airport/heliport that requires an obstacle departure procedure (ODP) to ensure obstacle avoidance.

(See OBSTACLE.)

(See OBSTRUCTION.)

PROPELLER (PROP) WASH (PROP BLAST)– The disturbed mass of air generated by the motion of a propeller.

PROPOSED BOUNDARY CROSSING TIME– Each center has a PBCT parameter for each internal airport. Proposed internal flight plans are transmitted to the adjacent center if the flight time along the proposed route from the departure airport to the center boundary is less than or equal to the value of PBCT or if airport adaptation specifies transmission regardless of PBCT.

PROPOSED DEPARTURE TIME– The time that the aircraft expects to become airborne.

PROTECTED AIRSPACE– The airspace on either side of an oceanic route/track that is equal to one-half the lateral separation minimum except where reduction of protected airspace has been authorized.

PROTECTED SEGMENT– The protected segment is a segment on the amended TFM route that is to be inhibited from automatic adapted route alteration by ERAM.

PT–

(See PROCEDURE TURN.)

PTP–

(See POINT-TO-POINT.)

PTS–

(See POLAR TRACK STRUCTURE.)

PUBLISHED INSTRUMENT APPROACH PROCEDURE VISUAL SEGMENT– A segment on an IAP chart annotated as “Fly Visual to Airport” or “Fly Visual.” A dashed arrow will indicate the visual flight path on the profile and plan view with an associated note on the approximate heading and distance. The visual segment should be flown as a dead reckoning course while maintaining visual conditions.

PUBLISHED ROUTE– A route for which an IFR altitude has been established and published; e.g., Federal Airways, Jet Routes, Area Navigation Routes, Specified Direct Routes.

PWS–

(See PREDICTIVE WIND SHEAR ALERT SYSTEM.)

Q

Q ROUTE– ‘Q’ is the designator assigned to published RNAV routes used by the United States.

QFE– The atmospheric pressure at aerodrome elevation (or at runway threshold).

QNE– The barometric pressure used for the standard altimeter setting (29.92 inches Hg.).

QNH– The barometric pressure as reported by a particular station.

QUADRANT– A quarter part of a circle, centered on a NAVAID, oriented clockwise from magnetic north

as follows: NE quadrant 000-089, SE quadrant 090-179, SW quadrant 180-269, NW quadrant 270-359.

QUEUING–

(See STAGING/QUEUING.)

QUICK LOOK– A feature of the EAS and ARTS which provides the controller the capability to display full data blocks of tracked aircraft from other control positions.

R

RADAR– A device which, by measuring the time interval between transmission and reception of radio pulses and correlating the angular orientation of the radiated antenna beam or beams in azimuth and/or elevation, provides information on range, azimuth, and/or elevation of objects in the path of the transmitted pulses.

a. Primary Radar– A radar system in which a minute portion of a radio pulse transmitted from a site is reflected by an object and then received back at that site for processing and display at an air traffic control facility.

b. Secondary Radar/Radar Beacon (ATCRBS)– A radar system in which the object to be detected is fitted with cooperative equipment in the form of a radio receiver/transmitter (transponder). Radar pulses transmitted from the searching transmitter/receiver (interrogator) site are received in the cooperative equipment and used to trigger a distinctive transmission from the transponder. This reply transmission, rather than a reflected signal, is then received back at the transmitter/receiver site for processing and display at an air traffic control facility.

(See INTERROGATOR.)

(See TRANSPONDER.)

(See ICAO term RADAR.)

(Refer to AIM.)

RADAR [ICAO]– A radio detection device which provides information on range, azimuth and/or elevation of objects.

a. Primary Radar– Radar system which uses reflected radio signals.

b. Secondary Radar– Radar system wherein a radio signal transmitted from a radar station initiates the transmission of a radio signal from another station.

RADAR ADVISORY– The provision of advice and information based on radar observations.

(See ADVISORY SERVICE.)

RADAR ALTIMETER–

(See RADIO ALTIMETER.)

RADAR APPROACH– An instrument approach procedure which utilizes Precision Approach Radar (PAR) or Airport Surveillance Radar (ASR).

(See AIRPORT SURVEILLANCE RADAR.)

(See INSTRUMENT APPROACH PROCEDURE.)

(See PRECISION APPROACH RADAR.)

(See SURVEILLANCE APPROACH.)

(See ICAO term RADAR APPROACH.)

(Refer to AIM.)

RADAR APPROACH [ICAO]– An approach, executed by an aircraft, under the direction of a radar controller.

RADAR APPROACH CONTROL FACILITY– A terminal ATC facility that uses radar and nonradar capabilities to provide approach control services to aircraft arriving, departing, or transiting airspace controlled by the facility.

(See APPROACH CONTROL SERVICE.)

a. Provides radar ATC services to aircraft operating in the vicinity of one or more civil and/or military airports in a terminal area. The facility may provide services of a ground controlled approach (GCA); i.e., ASR and PAR approaches. A radar approach control facility may be operated by FAA, USAF, US Army, USN, USMC, or jointly by FAA and a military service. Specific facility nomenclatures are used for administrative purposes only and are related to the physical location of the facility and the operating service generally as follows:

1. Army Radar Approach Control (ARAC) (US Army).

2. Radar Air Traffic Control Facility (RATCF) (USN/FAA and USMC/FAA).

3. Radar Approach Control (RAPCON) (USAF/FAA, USN/FAA, and USMC/FAA).

4. Terminal Radar Approach Control (TRACON) (FAA).

5. Air Traffic Control Tower (ATCT) (FAA). (Only those towers delegated approach control authority.)

RADAR ARRIVAL– An aircraft arriving at an airport served by a radar facility and in radar contact with the facility.

(See NONRADAR.)

RADAR BEACON–

(See RADAR.)

RADAR CLUTTER [ICAO]– The visual indication on a radar display of unwanted signals.

RADAR CONTACT–

a. Used by ATC to inform an aircraft that it is identified using an approved ATC surveillance source on an air traffic controller’s display and that radar flight following will be provided until radar service is terminated. Radar service may also be provided within the limits of necessity and capability. When a pilot is informed of “radar contact,” he/she automatically discontinues reporting over compulsory reporting points.

(See ATC SURVEILLANCE SOURCE.)

(See RADAR CONTACT LOST.)

(See RADAR FLIGHT FOLLOWING.)

(See RADAR SERVICE.)

(See RADAR SERVICE TERMINATED.)

(Refer to AIM.)

b. The term used to inform the controller that the aircraft is identified and approval is granted for the aircraft to enter the receiving controllers airspace.

(See ICAO term RADAR CONTACT.)

RADAR CONTACT [ICAO]– The situation which exists when the radar blip or radar position symbol of a particular aircraft is seen and identified on a radar display.

RADAR CONTACT LOST– Used by ATC to inform a pilot that the surveillance data used to determine the aircraft’s position is no longer being received, or is no longer reliable and radar service is no longer being provided. The loss may be attributed to several factors including the aircraft merging with weather or ground clutter, the aircraft operating below radar line of sight coverage, the aircraft entering an area of poor radar return, failure of the aircraft’s equipment, or failure of the surveillance equipment.

(See CLUTTER.)

(See RADAR CONTACT.)

RADAR ENVIRONMENT– An area in which radar service may be provided.

(See ADDITIONAL SERVICES.)

(See RADAR CONTACT.)

(See RADAR SERVICE.)

(See TRAFFIC ADVISORIES.)

RADAR FLIGHT FOLLOWING– The observation of the progress of radar-identified aircraft, whose primary navigation is being provided by the pilot, wherein the controller retains and correlates the aircraft identity with the appropriate target or target symbol displayed on the radar scope.

(See RADAR CONTACT.)

(See RADAR SERVICE.)

(Refer to AIM.)

RADAR IDENTIFICATION– The process of ascertaining that an observed radar target is the radar return from a particular aircraft.

(See RADAR CONTACT.)

(See RADAR SERVICE.)

RADAR IDENTIFIED AIRCRAFT– An aircraft, the position of which has been correlated with an observed target or symbol on the radar display.

(See RADAR CONTACT.)

(See RADAR CONTACT LOST.)

RADAR MONITORING–

(See RADAR SERVICE.)

RADAR NAVIGATIONAL GUIDANCE–

(See RADAR SERVICE.)

RADAR POINT OUT– An action taken by a controller to transfer the radar identification of an aircraft to another controller if the aircraft will or may enter the airspace or protected airspace of another controller and radio communications will not be transferred.

RADAR REQUIRED– A term displayed on charts and approach plates and included in FDC NOTAMS to alert pilots that segments of either an instrument approach procedure or a route are not navigable because of either the absence or unusability of a NAVAID. The pilot can expect to be provided radar navigational guidance while transiting segments labeled with this term.

(See RADAR ROUTE.)

(See RADAR SERVICE.)

RADAR ROUTE– A flight path or route over which an aircraft is vectored. Navigational guidance and altitude assignments are provided by ATC.

(See FLIGHT PATH.)

(See ROUTE.)

RADAR SEPARATION–

(See RADAR SERVICE.)

RADAR SERVICE– A term which encompasses one or more of the following services based on the use of

radar which can be provided by a controller to a pilot of a radar identified aircraft.

a. Radar Monitoring– The radar flight-following of aircraft, whose primary navigation is being performed by the pilot, to observe and note deviations from its authorized flight path, airway, or route. When being applied specifically to radar monitoring of instrument approaches; i.e., with precision approach radar (PAR) or radar monitoring of simultaneous ILS, RNAV and GLS approaches, it includes advice and instructions whenever an aircraft nears or exceeds the prescribed PAR safety limit or simultaneous ILS RNAV and GLS no transgression zone.

(See ADDITIONAL SERVICES.)

(See TRAFFIC ADVISORIES.)

b. Radar Navigational Guidance– Vectoring aircraft to provide course guidance.

c. Radar Separation– Radar spacing of aircraft in accordance with established minima.

(See ICAO term RADAR SERVICE.)

RADAR SERVICE [ICAO]– Term used to indicate a service provided directly by means of radar.

a. Monitoring– The use of radar for the purpose of providing aircraft with information and advice relative to significant deviations from nominal flight path.

b. Separation– The separation used when aircraft position information is derived from radar sources.

RADAR SERVICE TERMINATED– Used by ATC to inform a pilot that he/she will no longer be provided any of the services that could be received while in radar contact. Radar service is automatically terminated, and the pilot is not advised in the following cases:

a. An aircraft cancels its IFR flight plan, except within Class B airspace, Class C airspace, a TRSA, or where Basic Radar service is provided.

b. An aircraft conducting an instrument, visual, or contact approach has landed or has been instructed to change to advisory frequency.

c. An arriving VFR aircraft, receiving radar service to a tower-controlled airport within Class B airspace, Class C airspace, a TRSA, or where sequencing service is provided, has landed; or to all other airports, is instructed to change to tower or advisory frequency.

d. An aircraft completes a radar approach.

RADAR SURVEILLANCE– The radar observation of a given geographical area for the purpose of performing some radar function.

RADAR TRAFFIC ADVISORIES– Advisories issued to alert pilots to known or observed radar traffic which may affect the intended route of flight of their aircraft.

(See TRAFFIC ADVISORIES.)

RADAR TRAFFIC INFORMATION SERVICE–

(See TRAFFIC ADVISORIES.)

RADAR VECTORING [ICAO]– Provision of navigational guidance to aircraft in the form of specific headings, based on the use of radar.

RADIAL– A magnetic bearing extending from a VOR/VORTAC/TACAN navigation facility.

RADIO–

a. A device used for communication.

b. Used to refer to a flight service station; e.g., “Seattle Radio” is used to call Seattle FSS.

RADIO ALTIMETER– Aircraft equipment which makes use of the reflection of radio waves from the ground to determine the height of the aircraft above the surface.

RADIO BEACON–

(See NONDIRECTIONAL BEACON.)

RADIO DETECTION AND RANGING–

(See RADAR.)

RADIO MAGNETIC INDICATOR– An aircraft navigational instrument coupled with a gyro compass or similar compass that indicates the direction of a selected NAVAID and indicates bearing with respect to the heading of the aircraft.

RAIS–

(See REMOTE AIRPORT INFORMATION SERVICE.)

RAMP–

(See APRON.)

RANDOM ALTITUDE– An altitude inappropriate for direction of flight and/or not in accordance with FAA Order JO 7110.65, Paragraph 4–5–1, VERTICAL SEPARATION MINIMA.

RANDOM ROUTE– Any route not established or charted/published or not otherwise available to all users.

RC–

(See ROAD RECONNAISSANCE.)

RCAG–

(See REMOTE COMMUNICATIONS AIR/GROUND FACILITY.)

RCC–

(See RESCUE COORDINATION CENTER.)

RCO–

(See REMOTE COMMUNICATIONS OUTLET.)

RCR–

(See RUNWAY CONDITION READING.)

READ BACK– Repeat my message back to me.

RECEIVER AUTONOMOUS INTEGRITY MONITORING (RAIM)– A technique whereby a civil GNSS receiver/processor determines the integrity of the GNSS navigation signals without reference to sensors or non-DoD integrity systems other than the receiver itself. This determination is achieved by a consistency check among redundant pseudorange measurements.

RECEIVING CONTROLLER– A controller/facility receiving control of an aircraft from another controller/facility.

RECEIVING FACILITY–

(See RECEIVING CONTROLLER.)

RECONFORMANCE– The automated process of bringing an aircraft's Current Plan Trajectory into conformance with its track.

REDUCE SPEED TO (SPEED)–

(See SPEED ADJUSTMENT.)

REIL–

(See RUNWAY END IDENTIFIER LIGHTS.)

RELEASE TIME– A departure time restriction issued to a pilot by ATC (either directly or through an authorized relay) when necessary to separate a departing aircraft from other traffic.

(See ICAO term RELEASE TIME.)

RELEASE TIME [ICAO]– Time prior to which an aircraft should be given further clearance or prior to which it should not proceed in case of radio failure.

REMOTE AIRPORT INFORMATION SERVICE (RAIS)– A temporary service provided by facilities, which are not located on the landing airport, but have communication capability and automated weather reporting available to the pilot at the landing airport.

REMOTE COMMUNICATIONS AIR/GROUND FACILITY– An unmanned VHF/UHF transmitter/receiver facility which is used to expand ARTCC air/ground communications coverage and to facilitate direct contact between pilots and controllers. RCAG facilities are sometimes not equipped with emergency frequencies 121.5 MHz and 243.0 MHz.

(Refer to AIM.)

REMOTE COMMUNICATIONS OUTLET (RCO)– An unmanned communications facility remotely controlled by air traffic personnel. RCOs serve FSSs. Remote Transmitter/Receivers (RTR) serve terminal ATC facilities. An RCO or RTR may be UHF or VHF and will extend the communication range of the air traffic facility. There are several classes of RCOs and RTRs. The class is determined by the number of transmitters or receivers. Classes A through G are used primarily for air/ground purposes. RCO and RTR class O facilities are nonprotected outlets subject to undetected and prolonged outages. RCO (O's) and RTR (O's) were established for the express purpose of providing ground-to-ground communications between air traffic control specialists and pilots located at a satellite airport for delivering en route clearances, issuing departure authorizations, and acknowledging instrument flight rules cancellations or departure/landing times. As a secondary function, they may be used for advisory purposes whenever the aircraft is below the coverage of the primary air/ground frequency.

REMOTE TRANSMITTER/RECEIVER (RTR)–

(See REMOTE COMMUNICATIONS OUTLET.)

REPORT– Used to instruct pilots to advise ATC of specified information; e.g., "Report passing Hamilton VOR."

REPORTING POINT– A geographical location in relation to which the position of an aircraft is reported.

(See COMPULSORY REPORTING POINTS.)

(See ICAO term REPORTING POINT.)

(Refer to AIM.)

REPORTING POINT [ICAO]– A specified geographical location in relation to which the position of an aircraft can be reported.

REQUEST FULL ROUTE CLEARANCE– Used by pilots to request that the entire route of flight be read verbatim in an ATC clearance. Such request should be made to preclude receiving an ATC clearance based on the original filed flight plan when

a filed IFR flight plan has been revised by the pilot, company, or operations prior to departure.

REQUIRED NAVIGATION PERFORMANCE (RNP)– A statement of the navigational performance necessary for operation within a defined airspace. The following terms are commonly associated with RNP:

a. Required Navigation Performance Level or Type (RNP-X). A value, in nautical miles (NM), from the intended horizontal position within which an aircraft would be at least 95-percent of the total flying time.

b. Advanced – Required Navigation Performance (A-RNP). A navigation specification based on RNP that requires advanced functions such as scalable RNP, radius-to-fix (RF) legs, and tactical parallel offsets. This sophisticated Navigation Specification (NavSpec) is designated by the abbreviation “A-RNP”.

c. Required Navigation Performance (RNP) Airspace. A generic term designating airspace, route(s), leg(s), operation(s), or procedure(s) where minimum required navigational performance (RNP) have been established.

d. Actual Navigation Performance (ANP). A measure of the current estimated navigational performance. Also referred to as Estimated Position Error (EPE).

e. Estimated Position Error (EPE). A measure of the current estimated navigational performance. Also referred to as Actual Navigation Performance (ANP).

f. Lateral Navigation (LNAV). A function of area navigation (RNAV) equipment which calculates, displays, and provides lateral guidance to a profile or path.

g. Vertical Navigation (VNAV). A function of area navigation (RNAV) equipment which calculates, displays, and provides vertical guidance to a profile or path.

RESCUE COORDINATION CENTER (RCC)– A search and rescue (SAR) facility equipped and manned to coordinate and control SAR operations in an area designated by the SAR plan. The U.S. Coast Guard and the U.S. Air Force have responsibility for the operation of RCCs.

(See ICAO term **RESCUE CO-ORDINATION CENTRE**.)

RESCUE CO-ORDINATION CENTRE [ICAO]– A unit responsible for promoting efficient organization of search and rescue service and for coordinating the conduct of search and rescue operations within a search and rescue region.

RESOLUTION ADVISORY– A display indication given to the pilot by the Traffic alert and Collision Avoidance System (TCAS II) recommending a maneuver to increase vertical separation relative to an intruding aircraft. Positive, negative, and vertical speed limit (VSL) advisories constitute the resolution advisories. A resolution advisory is also classified as corrective or preventive.

RESTRICTED AREA–

(See **SPECIAL USE AIRSPACE**.)

(See ICAO term **RESTRICTED AREA**.)

RESTRICTED AREA [ICAO]– An airspace of defined dimensions, above the land areas or territorial waters of a State, within which the flight of aircraft is restricted in accordance with certain specified conditions.

RESUME NORMAL SPEED– Used by ATC to advise a pilot to resume an aircraft’s normal operating speed. It is issued to terminate a speed adjustment where no published speed restrictions apply. It does not delete speed restrictions in published procedures of upcoming segments of flight. This does not relieve the pilot of those speed restrictions that are applicable to 14 CFR Section 91.117.

RESUME OWN NAVIGATION– Used by ATC to advise a pilot to resume his/her own navigational responsibility. It is issued after completion of a radar vector or when radar contact is lost while the aircraft is being radar vectored.

(See **RADAR CONTACT LOST**.)

(See **RADAR SERVICE TERMINATED**.)

RESUME PUBLISHED SPEED– Used by ATC to advise a pilot to resume published speed restrictions that are applicable to a SID, STAR, or other instrument procedure. It is issued to terminate a speed adjustment where speed restrictions are published on a charted procedure.

RMI–

(See **RADIO MAGNETIC INDICATOR**.)

RNAV–

(See **AREA NAVIGATION (RNAV)**.)

RNAV APPROACH– An instrument approach procedure which relies on aircraft area navigation equipment for navigational guidance.

(See AREA NAVIGATION (RNAV).)

(See INSTRUMENT APPROACH PROCEDURE.)

ROAD RECONNAISSANCE (RC)– Military activity requiring navigation along roads, railroads, and rivers. Reconnaissance route/route segments are seldom along a straight line and normally require a lateral route width of 10 NM to 30 NM and an altitude range of 500 feet to 10,000 feet AGL.

ROGER– I have received all of your last transmission. It should not be used to answer a question requiring a yes or a no answer.

(See AFFIRMATIVE.)

(See NEGATIVE.)

ROLLOUT RVR–

(See VISIBILITY.)

ROTOR WASH– A phenomenon resulting from the vertical down wash of air generated by the main rotor(s) of a helicopter.

ROUTE– A defined path, consisting of one or more courses in a horizontal plane, which aircraft traverse over the surface of the earth.

(See AIRWAY.)

(See JET ROUTE.)

(See PUBLISHED ROUTE.)

(See UNPUBLISHED ROUTE.)

ROUTE ACTION NOTIFICATION– EDST notification that a PAR/PDR/PDAR has been applied to the flight plan.

(See ATC PREFERRED ROUTE NOTIFICATION.)

(See EN ROUTE DECISION SUPPORT TOOL.)

ROUTE SEGMENT– As used in Air Traffic Control, a part of a route that can be defined by two navigational fixes, two NAVAIDS, or a fix and a NAVAID.

(See FIX.)

(See ROUTE.)

(See ICAO term ROUTE SEGMENT.)

ROUTE SEGMENT [ICAO]– A portion of a route to be flown, as defined by two consecutive significant points specified in a flight plan.

RSA–

(See RUNWAY SAFETY AREA.)

RTR–

(See REMOTE TRANSMITTER/RECEIVER.)

RUNWAY– A defined rectangular area on a land airport prepared for the landing and takeoff run of aircraft along its length. Runways are normally numbered in relation to their magnetic direction rounded off to the nearest 10 degrees; e.g., Runway 1, Runway 25.

(See PARALLEL RUNWAYS.)

(See ICAO term RUNWAY.)

RUNWAY [ICAO]– A defined rectangular area on a land aerodrome prepared for the landing and takeoff of aircraft.

RUNWAY CENTERLINE LIGHTING–

(See AIRPORT LIGHTING.)

RUNWAY CONDITION CODES (RwyCC)– Numerical readings, provided by airport operators, that indicate runway surface contamination (for example, slush, ice, rain, etc.). These values range from “1” (poor) to “6” (dry) and must be included on the ATIS when the reportable condition is less than 6 in any one or more of the three runway zones (touchdown, midpoint, rollout).

RUNWAY CONDITION READING– Numerical decelerometer readings relayed by air traffic controllers at USAF and certain civil bases for use by the pilot in determining runway braking action. These readings are routinely relayed only to USAF and Air National Guard Aircraft.

(See BRAKING ACTION.)

RUNWAY CONDITION REPORT (RwyCR)– A data collection worksheet used by airport operators that correlates the runway percentage of coverage along with the depth and type of contaminant for the purpose of creating a FICON NOTAM.

(See RUNWAY CONDITION CODES.)

RUNWAY END IDENTIFIER LIGHTS (REIL)–

(See AIRPORT LIGHTING.)

RUNWAY ENTRANCE LIGHTS (REL)– An array of red lights which include the first light at the hold line followed by a series of evenly spaced lights to the runway edge aligned with the taxiway centerline, and one additional light at the runway centerline in line with the last two lights before the runway edge.

RUNWAY GRADIENT– The average slope, measured in percent, between two ends or points on a

runway. Runway gradient is depicted on Government aerodrome sketches when total runway gradient exceeds 0.3%.

RUNWAY HEADING– The magnetic direction that corresponds with the runway centerline extended, not the painted runway number. When cleared to “fly or maintain runway heading,” pilots are expected to fly or maintain the heading that corresponds with the extended centerline of the departure runway. Drift correction shall not be applied; e.g., Runway 4, actual magnetic heading of the runway centerline 044, fly 044.

RUNWAY IN USE/ACTIVE RUNWAY/DUTY RUNWAY– Any runway or runways currently being used for takeoff or landing. When multiple runways are used, they are all considered active runways. In the metering sense, a selectable adapted item which specifies the landing runway configuration or direction of traffic flow. The adapted optimum flight plan from each transition fix to the vertex is determined by the runway configuration for arrival metering processing purposes.

RUNWAY LIGHTS–

(See AIRPORT LIGHTING.)

RUNWAY MARKINGS–

(See AIRPORT MARKING AIDS.)

RUNWAY OVERRUN– In military aviation exclusively, a stabilized or paved area beyond the end of a runway, of the same width as the runway plus shoulders, centered on the extended runway centerline.

RUNWAY PROFILE DESCENT– An instrument flight rules (IFR) air traffic control arrival procedure to a runway published for pilot use in graphic and/or textual form and may be associated with a STAR. Runway Profile Descents provide routing and may depict crossing altitudes, speed restrictions, and headings to be flown from the en route structure to the point where the pilot will receive clearance for and execute an instrument approach procedure. A Runway Profile Descent may apply to more than one runway if so stated on the chart.

(Refer to AIM.)

RUNWAY SAFETY AREA– A defined surface surrounding the runway prepared, or suitable, for reducing the risk of damage to airplanes in the event of an undershoot, overshoot, or excursion from the

runway. The dimensions of the RSA vary and can be determined by using the criteria contained within AC 150/5300-13, Airport Design, Chapter 3. Figure 3–1 in AC 150/5300-13 depicts the RSA. The design standards dictate that the RSA shall be:

a. Cleared, graded, and have no potentially hazardous ruts, humps, depressions, or other surface variations;

b. Drained by grading or storm sewers to prevent water accumulation;

c. Capable, under dry conditions, of supporting snow removal equipment, aircraft rescue and firefighting equipment, and the occasional passage of aircraft without causing structural damage to the aircraft; and,

d. Free of objects, except for objects that need to be located in the runway safety area because of their function. These objects shall be constructed on low impact resistant supports (frangible mounted structures) to the lowest practical height with the frangible point no higher than 3 inches above grade.

(Refer to AC 150/5300-13, Airport Design, Chapter 3.)

RUNWAY STATUS LIGHTS (RWSL) SYSTEM–

The RWSL is a system of runway and taxiway lighting to provide pilots increased situational awareness by illuminating runway entry lights (REL) when the runway is unsafe for entry or crossing, and take-off hold lights (THL) when the runway is unsafe for departure.

RUNWAY TRANSITION–

a. Conventional STARs/SIDs. The portion of a STAR/SID that serves a particular runway or runways at an airport.

b. RNAV STARs/SIDs. Defines a path(s) from the common route to the final point(s) on a STAR. For a SID, the common route that serves a particular runway or runways at an airport.

RUNWAY USE PROGRAM– A noise abatement runway selection plan designed to enhance noise abatement efforts with regard to airport communities for arriving and departing aircraft. These plans are developed into runway use programs and apply to all turbojet aircraft 12,500 pounds or heavier; turbojet aircraft less than 12,500 pounds are included only if the airport proprietor determines that the aircraft creates a noise problem. Runway use programs are coordinated with FAA offices, and safety criteria used in these programs are developed by the Office of

Flight Operations. Runway use programs are administered by the Air Traffic Service as “Formal” or “Informal” programs.

a. Formal Runway Use Program– An approved noise abatement program which is defined and acknowledged in a Letter of Understanding between Flight Operations, Air Traffic Service, the airport proprietor, and the users. Once established, participation in the program is mandatory for aircraft operators and pilots as provided for in 14 CFR Section 91.129.

b. Informal Runway Use Program– An approved noise abatement program which does not require a

Letter of Understanding, and participation in the program is voluntary for aircraft operators/pilots.

RUNWAY VISIBILITY VALUE (RVV)–
(See VISIBILITY.)

RUNWAY VISUAL RANGE (RVR)–
(See VISIBILITY.)

RwyCC–
(See RUNWAY CONDITION CODES.)

RwyCR–
(See RUNWAY CONDITION REPORT.)

S

SAA–

(See SPECIAL ACTIVITY AIRSPACE.)

SAFETY ALERT– A safety alert issued by ATC to aircraft under their control if ATC is aware the aircraft is at an altitude which, in the controller’s judgment, places the aircraft in unsafe proximity to terrain, obstructions, or other aircraft. The controller may discontinue the issuance of further alerts if the pilot advises he/she is taking action to correct the situation or has the other aircraft in sight.

a. Terrain/Obstruction Alert– A safety alert issued by ATC to aircraft under their control if ATC is aware the aircraft is at an altitude which, in the controller’s judgment, places the aircraft in unsafe proximity to terrain/obstructions; e.g., “Low Altitude Alert, check your altitude immediately.”

b. Aircraft Conflict Alert– A safety alert issued by ATC to aircraft under their control if ATC is aware of an aircraft that is not under their control at an altitude which, in the controller’s judgment, places both aircraft in unsafe proximity to each other. With the alert, ATC will offer the pilot an alternate course of action when feasible; e.g., “Traffic Alert, advise you turn right heading zero niner zero or climb to eight thousand immediately.”

Note: The issuance of a safety alert is contingent upon the capability of the controller to have an awareness of an unsafe condition. The course of action provided will be predicated on other traffic under ATC control. Once the alert is issued, it is solely the pilot’s prerogative to determine what course of action, if any, he/she will take.

SAFETY LOGIC SYSTEM– A software enhancement to ASDE–3, ASDE–X, and ASSC, that predicts the path of aircraft landing and/or departing, and/or vehicular movements on runways. Visual and aural alarms are activated when the safety logic projects a potential collision. The Airport Movement Area Safety System (AMASS) is a safety logic system enhancement to the ASDE–3. The Safety Logic System for ASDE–X and ASSC is an integral part of the software program.

SAFETY LOGIC SYSTEM ALERTS–

a. ALERT– An actual situation involving two real safety logic tracks (aircraft/aircraft, aircraft/vehicle,

or aircraft/other tangible object) that safety logic has predicted will result in an imminent collision, based upon the current set of Safety Logic parameters.

b. FALSE ALERT–

1. Alerts generated by one or more false surface–radar targets that the system has interpreted as real tracks and placed into safety logic.

2. Alerts in which the safety logic software did not perform correctly, based upon the design specifications and the current set of Safety Logic parameters.

3. The alert is generated by surface radar targets caused by moderate or greater precipitation.

c. NUISANCE ALERT– An alert in which one or more of the following is true:

1. The alert is generated by a known situation that is not considered an unsafe operation, such as LAHSO or other approved operations.

2. The alert is generated by inaccurate secondary radar data received by the Safety Logic System.

3. One or more of the aircraft involved in the alert is not intending to use a runway (for example, helicopter, pipeline patrol, non–Mode C overflight, etc.).

d. VALID NON–ALERT– A situation in which the safety logic software correctly determines that an alert is not required, based upon the design specifications and the current set of Safety Logic parameters.

e. INVALID NON–ALERT– A situation in which the safety logic software did not issue an alert when an alert was required, based upon the design specifications.

SAIL BACK– A maneuver during high wind conditions (usually with power off) where float plane movement is controlled by water rudders/opening and closing cabin doors.

SAME DIRECTION AIRCRAFT– Aircraft are operating in the same direction when:

a. They are following the same track in the same direction; or

b. Their tracks are parallel and the aircraft are flying in the same direction; or

c. Their tracks intersect at an angle of less than 45 degrees.

SAR–

(See SEARCH AND RESCUE.)

SATELLITE-BASED AUGMENTATION SYSTEM (SBAS) – A wide coverage augmentation system in which the user receives augmentation information from a satellite-based transmitter.

(See WIDE-AREA AUGMENTATION SYSTEM (WAAS).)

SAY AGAIN– Used to request a repeat of the last transmission. Usually specifies transmission or portion thereof not understood or received; e.g., “Say again all after ABRAM VOR.”

SAY ALTITUDE– Used by ATC to ascertain an aircraft’s specific altitude/flight level. When the aircraft is climbing or descending, the pilot should state the indicated altitude rounded to the nearest 100 feet.

SAY HEADING– Used by ATC to request an aircraft heading. The pilot should state the actual heading of the aircraft.

SCHEDULED TIME OF ARRIVAL (STA)– A STA is the desired time that an aircraft should cross a certain point (landing or metering fix). It takes other traffic and airspace configuration into account. A STA time shows the results of the TBFM scheduler that has calculated an arrival time according to parameters such as optimized spacing, aircraft performance, and weather.

SDF–

(See SIMPLIFIED DIRECTIONAL FACILITY.)

SEA LANE– A designated portion of water outlined by visual surface markers for and intended to be used by aircraft designed to operate on water.

SEARCH AND RESCUE– A service which seeks missing aircraft and assists those found to be in need of assistance. It is a cooperative effort using the facilities and services of available Federal, state and local agencies. The U.S. Coast Guard is responsible for coordination of search and rescue for the Maritime Region, and the U.S. Air Force is responsible for search and rescue for the Inland Region. Information pertinent to search and rescue should be passed through any air traffic facility or be transmitted

directly to the Rescue Coordination Center by telephone.

(See FLIGHT SERVICE STATION.)

(See RESCUE COORDINATION CENTER.)

(Refer to AIM.)

SEARCH AND RESCUE FACILITY– A facility responsible for maintaining and operating a search and rescue (SAR) service to render aid to persons and property in distress. It is any SAR unit, station, NET, or other operational activity which can be usefully employed during an SAR Mission; e.g., a Civil Air Patrol Wing, or a Coast Guard Station.

(See SEARCH AND RESCUE.)

SECNOT–

(See SECURITY NOTICE.)

SECONDARY RADAR TARGET– A target derived from a transponder return presented on a radar display.

SECTIONAL AERONAUTICAL CHARTS–

(See AERONAUTICAL CHART.)

SECTOR LIST DROP INTERVAL– A parameter number of minutes after the meter fix time when arrival aircraft will be deleted from the arrival sector list.

SECURITY NOTICE (SECNOT) – A SECNOT is a request originated by the Air Traffic Security Coordinator (ATSC) for an extensive communications search for aircraft involved, or suspected of being involved, in a security violation, or are considered a security risk. A SECNOT will include the aircraft identification, search area, and expiration time. The search area, as defined by the ATSC, could be a single airport, multiple airports, a radius of an airport or fix, or a route of flight. Once the expiration time has been reached, the SECNOT is considered to be canceled.

SECURITY SERVICES AIRSPACE – Areas established through the regulatory process or by NOTAM, issued by the Administrator under title 14, CFR, sections 99.7, 91.141, and 91.139, which specify that ATC security services are required; i.e., ADIZ or temporary flight rules areas.

SEE AND AVOID– When weather conditions permit, pilots operating IFR or VFR are required to observe and maneuver to avoid other aircraft. Right-of-way rules are contained in 14 CFR Part 91.

SEGMENTED CIRCLE– A system of visual indicators designed to provide traffic pattern

information at airports without operating control towers.

(Refer to AIM.)

SEGMENTS OF AN INSTRUMENT APPROACH PROCEDURE– An instrument approach procedure may have as many as four separate segments depending on how the approach procedure is structured.

a. Initial Approach– The segment between the initial approach fix and the intermediate fix or the point where the aircraft is established on the intermediate course or final approach course.

(See ICAO term INITIAL APPROACH SEGMENT.)

b. Intermediate Approach– The segment between the intermediate fix or point and the final approach fix.

(See ICAO term INTERMEDIATE APPROACH SEGMENT.)

c. Final Approach– The segment between the final approach fix or point and the runway, airport, or missed approach point.

(See ICAO term FINAL APPROACH SEGMENT.)

d. Missed Approach– The segment between the missed approach point or the point of arrival at decision height and the missed approach fix at the prescribed altitude.

(Refer to 14 CFR Part 97.)

(See ICAO term MISSED APPROACH PROCEDURE.)

SEPARATION– In air traffic control, the spacing of aircraft to achieve their safe and orderly movement in flight and while landing and taking off.

(See SEPARATION MINIMA.)

(See ICAO term SEPARATION.)

SEPARATION [ICAO]– Spacing between aircraft, levels or tracks.

SEPARATION MINIMA– The minimum longitudinal, lateral, or vertical distances by which aircraft are spaced through the application of air traffic control procedures.

(See SEPARATION.)

SERVICE– A generic term that designates functions or assistance available from or rendered by air traffic control. For example, Class C service would denote the ATC services provided within a Class C airspace area.

SEVERE WEATHER AVOIDANCE PLAN (SWAP)– An approved plan to minimize the affect of severe weather on traffic flows in impacted terminal and/or ARTCC areas. A SWAP is normally implemented to provide the least disruption to the ATC system when flight through portions of airspace is difficult or impossible due to severe weather.

SEVERE WEATHER FORECAST ALERTS– Preliminary messages issued in order to alert users that a Severe Weather Watch Bulletin (WW) is being issued. These messages define areas of possible severe thunderstorms or tornado activity. The messages are unscheduled and issued as required by the Storm Prediction Center (SPC) at Norman, Oklahoma.

(See AIRMET.)

(See CONVECTIVE SIGMET.)

(See CWA.)

(See SIGMET.)

SFA–

(See SINGLE FREQUENCY APPROACH.)

SFO–

(See SIMULATED FLAMEOUT.)

SHF–

(See SUPER HIGH FREQUENCY.)

SHORT RANGE CLEARANCE– A clearance issued to a departing IFR flight which authorizes IFR flight to a specific fix short of the destination while air traffic control facilities are coordinating and obtaining the complete clearance.

SHORT TAKEOFF AND LANDING AIRCRAFT (STOL)– An aircraft which, at some weight within its approved operating weight, is capable of operating from a runway in compliance with the applicable STOL characteristics, airworthiness, operations, noise, and pollution standards.

(See VERTICAL TAKEOFF AND LANDING AIRCRAFT.)

SIAP–

(See STANDARD INSTRUMENT APPROACH PROCEDURE.)

SID–

(See STANDARD INSTRUMENT DEPARTURE.)

SIDESTEP MANEUVER– A visual maneuver accomplished by a pilot at the completion of an instrument approach to permit a straight-in landing on a parallel runway not more than 1,200 feet to either

side of the runway to which the instrument approach was conducted.

(Refer to AIM.)

SIGMET– A weather advisory issued concerning weather significant to the safety of all aircraft. SIGMET advisories cover severe and extreme turbulence, severe icing, and widespread dust or sandstorms that reduce visibility to less than 3 miles.

(See AIRMET.)

(See AWW.)

(See CONVECTIVE SIGMET.)

(See CWA.)

(See ICAO term SIGMET INFORMATION.)

(Refer to AIM.)

SIGMET INFORMATION [ICAO]– Information issued by a meteorological watch office concerning the occurrence or expected occurrence of specified en-route weather phenomena which may affect the safety of aircraft operations.

SIGNIFICANT METEOROLOGICAL INFORMATION–

(See SIGMET.)

SIGNIFICANT POINT– A point, whether a named intersection, a NAVAID, a fix derived from a NAVAID(s), or geographical coordinate expressed in degrees of latitude and longitude, which is established for the purpose of providing separation, as a reporting point, or to delineate a route of flight.

SIMPLIFIED DIRECTIONAL FACILITY (SDF)– A NAVAID used for nonprecision instrument approaches. The final approach course is similar to that of an ILS localizer except that the SDF course may be offset from the runway, generally not more than 3 degrees, and the course may be wider than the localizer, resulting in a lower degree of accuracy.

(Refer to AIM.)

SIMULATED FLAMEOUT– A practice approach by a jet aircraft (normally military) at idle thrust to a runway. The approach may start at a runway (high key) and may continue on a relatively high and wide downwind leg with a continuous turn to final. It terminates in landing or low approach. The purpose of this approach is to simulate a flameout.

(See FLAMEOUT.)

SIMULTANEOUS CLOSE PARALLEL APPROACHES– A simultaneous, independent

approach operation permitting ILS/RNAV/GLS approaches to airports having parallel runways separated by at least 3,000 feet and less than 4,300–feet between centerlines. Aircraft are permitted to pass each other during these simultaneous operations. Integral parts of a total system are radar, NTZ monitoring with enhanced FMA color displays that include aural and visual alerts and predictive aircraft position software, communications override, ATC procedures, an Attention All Users Page (AAUP), PRM in the approach name, and appropriate ground based and airborne equipment. High update rate surveillance sensor required for certain runway or approach course separations.

SIMULTANEOUS (CONVERGING) DEPENDENT APPROACHES– An approach operation permitting ILS/RNAV/GLS approaches to runways or missed approach courses that intersect where required minimum spacing between the aircraft on each final approach course is required.

SIMULTANEOUS (CONVERGING) INDEPENDENT APPROACHES– An approach operation permitting ILS/RNAV/GLS approaches to non-parallel runways where approach procedure design maintains the required aircraft spacing throughout the approach and missed approach and hence the operations may be conducted independently.

SIMULTANEOUS ILS APPROACHES– An approach system permitting simultaneous ILS approaches to airports having parallel runways separated by at least 4,300 feet between centerlines. Integral parts of a total system are ILS, radar, communications, ATC procedures, and appropriate airborne equipment.

(See PARALLEL RUNWAYS.)

(Refer to AIM.)

SIMULTANEOUS OFFSET INSTRUMENT APPROACH (SOIA)– An instrument landing system comprised of an ILS PRM, RNAV PRM or GLS PRM approach to one runway and an offset LDA PRM with glideslope or an RNAV PRM or GLS PRM approach utilizing vertical guidance to another where parallel runway spaced less than 3,000 feet and at least 750 feet apart. The approach courses converge by 2.5 to 3 degrees. Simultaneous close parallel PRM approach procedures apply up to the point where the approach course separation becomes 3,000 feet, at the offset MAP. From the offset MAP

to the runway threshold, visual separation by the aircraft conducting the offset approach is utilized.

(Refer to AIM)

SIMULTANEOUS (PARALLEL) DEPENDENT APPROACHES- An approach operation permitting ILS/RNAV/GLS approaches to adjacent parallel runways where prescribed diagonal spacing must be maintained. Aircraft are not permitted to pass each other during simultaneous dependent operations. Integral parts of a total system ATC procedures, and appropriate airborne and ground based equipment.

SINGLE DIRECTION ROUTES- Preferred IFR Routes which are sometimes depicted on high altitude en route charts and which are normally flown in one direction only.

(See PREFERRED IFR ROUTES.)

(Refer to CHART SUPPLEMENT U.S.)

SINGLE FREQUENCY APPROACH- A service provided under a letter of agreement to military single-piloted turbojet aircraft which permits use of a single UHF frequency during approach for landing. Pilots will not normally be required to change frequency from the beginning of the approach to touchdown except that pilots conducting an en route descent are required to change frequency when control is transferred from the air route traffic control center to the terminal facility. The abbreviation "SFA" in the DOD FLIP IFR Supplement under "Communications" indicates this service is available at an aerodrome.

SINGLE-PILOTED AIRCRAFT- A military turbojet aircraft possessing one set of flight controls, tandem cockpits, or two sets of flight controls but operated by one pilot is considered single-piloted by ATC when determining the appropriate air traffic service to be applied.

(See SINGLE FREQUENCY APPROACH.)

SKYSPOTTER- A pilot who has received specialized training in observing and reporting inflight weather phenomena.

SLASH- A radar beacon reply displayed as an elongated target.

SLDI-

(See SECTOR LIST DROP INTERVAL.)

SLOT TIME-

(See METER FIX TIME/SLOT TIME.)

SLOW TAXI- To taxi a float plane at low power or low RPM.

SN-

(See SYSTEM STRATEGIC NAVIGATION.)

SPEAK SLOWER- Used in verbal communications as a request to reduce speech rate.

SPECIAL ACTIVITY AIRSPACE (SAA)- Any airspace with defined dimensions within the National Airspace System wherein limitations may be imposed upon aircraft operations. This airspace may be restricted areas, prohibited areas, military operations areas, air ATC assigned airspace, and any other designated airspace areas. The dimensions of this airspace are programmed into EDST and can be designated as either active or inactive by screen entry. Aircraft trajectories are constantly tested against the dimensions of active areas and alerts issued to the applicable sectors when violations are predicted.

(See EN ROUTE DECISION SUPPORT TOOL.)

SPECIAL AIR TRAFFIC RULES (SATR)- Rules that govern procedures for conducting flights in certain areas listed in 14 CFR Part 93. The term "SATR" is used in the United States to describe the rules for operations in specific areas designated in the Code of Federal Regulations.

(Refer to 14 CFR Part 93.)

SPECIAL EMERGENCY- A condition of air piracy or other hostile act by a person(s) aboard an aircraft which threatens the safety of the aircraft or its passengers.

SPECIAL FLIGHT RULES AREA (SFRA)- An area in the NAS, described in 14 CFR Part 93, wherein the flight of aircraft is subject to special traffic rules, unless otherwise authorized by air traffic control. Not all areas listed in 14 CFR Part 93 are designated SFRA, but special air traffic rules apply to all areas described in 14 CFR Part 93.

SPECIAL INSTRUMENT APPROACH PROCEDURE-

(See INSTRUMENT APPROACH PROCEDURE.)

SPECIAL USE AIRSPACE- Airspace of defined dimensions identified by an area on the surface of the earth wherein activities must be confined because of their nature and/or wherein limitations may be imposed upon aircraft operations that are not a part of those activities. Types of special use airspace are:

a. Alert Area- Airspace which may contain a high volume of pilot training activities or an unusual type

of aerial activity, neither of which is hazardous to aircraft. Alert Areas are depicted on aeronautical charts for the information of nonparticipating pilots. All activities within an Alert Area are conducted in accordance with Federal Aviation Regulations, and pilots of participating aircraft as well as pilots transiting the area are equally responsible for collision avoidance.

b. Controlled Firing Area– Airspace wherein activities are conducted under conditions so controlled as to eliminate hazards to nonparticipating aircraft and to ensure the safety of persons and property on the ground.

c. Military Operations Area (MOA)– Permanent and temporary MOAs are airspace established outside of Class A airspace area to separate or segregate certain nonhazardous military activities from IFR traffic and to identify for VFR traffic where these activities are conducted. Permanent MOAs are depicted on Sectional Aeronautical, VFR Terminal Area, and applicable En Route Low Altitude Charts.

Note: Temporary MOAs are not charted.

(Refer to AIM.)

d. Prohibited Area– Airspace designated under 14 CFR Part 73 within which no person may operate an aircraft without the permission of the using agency.

(Refer to AIM.)

(Refer to En Route Charts.)

e. Restricted Area– Permanent and temporary restricted areas are airspace designated under 14 CFR Part 73, within which the flight of aircraft, while not wholly prohibited, is subject to restriction. Most restricted areas are designated joint use and IFR/VFR operations in the area may be authorized by the controlling ATC facility when it is not being utilized by the using agency. Permanent restricted areas are depicted on Sectional Aeronautical, VFR Terminal Area, and applicable En Route charts. Where joint use is authorized, the name of the ATC controlling facility is also shown.

Note: Temporary restricted areas are not charted.

(Refer to 14 CFR Part 73.)

(Refer to AIM.)

f. Warning Area– A warning area is airspace of defined dimensions extending from 3 nautical miles outward from the coast of the United States, that contains activity that may be hazardous to

nonparticipating aircraft. The purpose of such warning area is to warn nonparticipating pilots of the potential danger. A warning area may be located over domestic or international waters or both.

SPECIAL VFR CONDITIONS– Meteorological conditions that are less than those required for basic VFR flight in Class B, C, D, or E surface areas and in which some aircraft are permitted flight under visual flight rules.

(See SPECIAL VFR OPERATIONS.)

(Refer to 14 CFR Part 91.)

SPECIAL VFR FLIGHT [ICAO]– A VFR flight cleared by air traffic control to operate within Class B, C, D, and E surface areas in metrological conditions below VMC.

SPECIAL VFR OPERATIONS– Aircraft operating in accordance with clearances within Class B, C, D, and E surface areas in weather conditions less than the basic VFR weather minima. Such operations must be requested by the pilot and approved by ATC.

(See SPECIAL VFR CONDITIONS.)

(See ICAO term SPECIAL VFR FLIGHT.)

SPEED–

(See AIRSPEED.)

(See GROUND SPEED.)

SPEED ADJUSTMENT– An ATC procedure used to request pilots to adjust aircraft speed to a specific value for the purpose of providing desired spacing. Pilots are expected to maintain a speed of plus or minus 10 knots or 0.02 Mach number of the specified speed. Examples of speed adjustments are:

a. “Increase/reduce speed to Mach point (number).”

b. “Increase/reduce speed to (speed in knots)” or “Increase/reduce speed (number of knots) knots.”

SPEED BRAKES– Moveable aerodynamic devices on aircraft that reduce airspeed during descent and landing.

SPEED SEGMENTS– Portions of the arrival route between the transition point and the vertex along the optimum flight path for which speeds and altitudes are specified. There is one set of arrival speed segments adapted from each transition point to each vertex. Each set may contain up to six segments.

SQUAWK (Mode, Code, Function)– Activate specific modes/codes/functions on the aircraft

transponder; e.g., “Squawk three/alpha, two one zero five, low.”

(See TRANSPONDER.)

STA–

(See SCHEDULED TIME OF ARRIVAL.)

STAGING/QUEUING– The placement, integration, and segregation of departure aircraft in designated movement areas of an airport by departure fix, EDCT, and/or restriction.

STAND BY– Means the controller or pilot must pause for a few seconds, usually to attend to other duties of a higher priority. Also means to wait as in “stand by for clearance.” The caller should reestablish contact if a delay is lengthy. “Stand by” is not an approval or denial.

STANDARD INSTRUMENT APPROACH PROCEDURE (SIAP)–

(See INSTRUMENT APPROACH PROCEDURE.)

STANDARD INSTRUMENT DEPARTURE (SID)–

A preplanned instrument flight rule (IFR) air traffic control (ATC) departure procedure printed for pilot/controller use in graphic form to provide obstacle clearance and a transition from the terminal area to the appropriate en route structure. SIDs are primarily designed for system enhancement to expedite traffic flow and to reduce pilot/controller workload. ATC clearance must always be received prior to flying a SID.

(See IFR TAKEOFF MINIMUMS AND DEPARTURE PROCEDURES.)

(See OBSTACLE DEPARTURE PROCEDURE.)

(Refer to AIM.)

STANDARD RATE TURN– A turn of three degrees per second.

STANDARD TERMINAL ARRIVAL (STAR)– A preplanned instrument flight rule (IFR) air traffic control arrival procedure published for pilot use in graphic and/or textual form. STARs provide transition from the en route structure to an outer fix or an instrument approach fix/arrival waypoint in the terminal area.

STANDARD TERMINAL ARRIVAL CHARTS–

(See AERONAUTICAL CHART.)

STANDARD TERMINAL AUTOMATION REPLACEMENT SYSTEM (STARS)–

(See DTAS.)

STAR–

(See STANDARD TERMINAL ARRIVAL.)

STATE AIRCRAFT– Aircraft used in military, customs and police service, in the exclusive service of any government or of any political subdivision thereof, including the government of any state, territory, or possession of the United States or the District of Columbia, but not including any government-owned aircraft engaged in carrying persons or property for commercial purposes.

STATIC RESTRICTIONS– Those restrictions that are usually not subject to change, fixed, in place, and/or published.

STATIONARY RESERVATIONS– Altitude reservations which encompass activities in a fixed area. Stationary reservations may include activities, such as special tests of weapons systems or equipment, certain U.S. Navy carrier, fleet, and anti-submarine operations, rocket, missile and drone operations, and certain aerial refueling or similar operations.

STEP TAXI– To taxi a float plane at full power or high RPM.

STEP TURN– A maneuver used to put a float plane in a planing configuration prior to entering an active sea lane for takeoff. The STEP TURN maneuver should only be used upon pilot request.

STEPDOWN FIX– A fix permitting additional descent within a segment of an instrument approach procedure by identifying a point at which a controlling obstacle has been safely overflown.

STEREO ROUTE– A routinely used route of flight established by users and ARTCCs identified by a coded name; e.g., ALPHA 2. These routes minimize flight plan handling and communications.

STOL AIRCRAFT–

(See SHORT TAKEOFF AND LANDING AIRCRAFT.)

STOP ALTITUDE SQUAWK– Used by ATC to inform an aircraft to turn off the automatic altitude reporting feature of its transponder. It is issued when

the verbally reported altitude varies 300 feet or more from the automatic altitude report.

(See ALTITUDE READOUT.)

(See TRANSPONDER.)

STOP AND GO– A procedure wherein an aircraft will land, make a complete stop on the runway, and then commence a takeoff from that point.

(See LOW APPROACH.)

(See OPTION APPROACH.)

STOP BURST–

(See STOP STREAM.)

STOP BUZZER–

(See STOP STREAM.)

STOP SQUAWK (Mode or Code)– Used by ATC to tell the pilot to turn specified functions of the aircraft transponder off.

(See STOP ALTITUDE SQUAWK.)

(See TRANSPONDER.)

STOP STREAM– Used by ATC to request a pilot to suspend electronic attack activity.

(See JAMMING.)

STOPOVER FLIGHT PLAN– A flight plan format which permits in a single submission the filing of a sequence of flight plans through interim full-stop destinations to a final destination.

STOPWAY– An area beyond the takeoff runway no less wide than the runway and centered upon the extended centerline of the runway, able to support the airplane during an aborted takeoff, without causing structural damage to the airplane, and designated by the airport authorities for use in decelerating the airplane during an aborted takeoff.

STRAIGHT-IN APPROACH IFR– An instrument approach wherein final approach is begun without first having executed a procedure turn, not necessarily completed with a straight-in landing or made to straight-in landing minimums.

(See LANDING MINIMUMS.)

(See STRAIGHT-IN APPROACH VFR.)

(See STRAIGHT-IN LANDING.)

STRAIGHT-IN APPROACH VFR– Entry into the traffic pattern by interception of the extended runway

centerline (final approach course) without executing any other portion of the traffic pattern.

(See TRAFFIC PATTERN.)

STRAIGHT-IN LANDING– A landing made on a runway aligned within 30° of the final approach course following completion of an instrument approach.

(See STRAIGHT-IN APPROACH IFR.)

STRAIGHT-IN LANDING MINIMUMS–

(See LANDING MINIMUMS.)

STRAIGHT-IN MINIMUMS–

(See STRAIGHT-IN LANDING MINIMUMS.)

STRATEGIC PLANNING– Planning whereby solutions are sought to resolve potential conflicts.

SUBSTITUTE ROUTE– A route assigned to pilots when any part of an airway or route is unusable because of NAVAID status. These routes consist of:

a. Substitute routes which are shown on U.S. Government charts.

b. Routes defined by ATC as specific NAVAID radials or courses.

c. Routes defined by ATC as direct to or between NAVAIDs.

SUNSET AND SUNRISE– The mean solar times of sunset and sunrise as published in the Nautical Almanac, converted to local standard time for the locality concerned. Within Alaska, the end of evening civil twilight and the beginning of morning civil twilight, as defined for each locality.

SUPPLEMENTAL WEATHER SERVICE LOCATION– Airport facilities staffed with contract personnel who take weather observations and provide current local weather to pilots via telephone or radio. (All other services are provided by the parent FSS.)

SUPPS– Refers to ICAO Document 7030 Regional Supplementary Procedures. SUPPS contain procedures for each ICAO Region which are unique to that Region and are not covered in the worldwide provisions identified in the ICAO Air Navigation Plan. Procedures contained in Chapter 8 are based in part on those published in SUPPS.

SURFACE AREA– The airspace contained by the lateral boundary of the Class B, C, D, or E airspace designated for an airport that begins at the surface and extends upward.

SURPIC– A description of surface vessels in the area of a Search and Rescue incident including their predicted positions and their characteristics.

(Refer to FAA Order JO 7110.65, Para 10–6–4, INFLIGHT CONTINGENCIES.)

SURVEILLANCE APPROACH– An instrument approach wherein the air traffic controller issues instructions, for pilot compliance, based on aircraft position in relation to the final approach course (azimuth), and the distance (range) from the end of the runway as displayed on the controller’s radar scope. The controller will provide recommended altitudes on final approach if requested by the pilot.

(Refer to AIM.)

SWAP–

(See SEVERE WEATHER AVOIDANCE PLAN.)

SWSL–

(See SUPPLEMENTAL WEATHER SERVICE LOCATION.)

SYSTEM STRATEGIC NAVIGATION– Military activity accomplished by navigating along a preplanned route using internal aircraft systems to maintain a desired track. This activity normally requires a lateral route width of 10 NM and altitude range of 1,000 feet to 6,000 feet AGL with some route segments that permit terrain following.

T

TACAN–

(See TACTICAL AIR NAVIGATION.)

TACAN-ONLY AIRCRAFT– An aircraft, normally military, possessing TACAN with DME but no VOR navigational system capability. Clearances must specify TACAN or VORTAC fixes and approaches.

TACTICAL AIR NAVIGATION (TCAN)– An ultra-high frequency electronic rho-theta air navigation aid which provides suitably equipped aircraft a continuous indication of bearing and distance to the TACAN station.

(See VORTAC.)

(Refer to AIM.)

TAILWIND– Any wind more than 90 degrees to the longitudinal axis of the runway. The magnetic direction of the runway shall be used as the basis for determining the longitudinal axis.

TAKEOFF AREA–

(See LANDING AREA.)

TAKEOFF DISTANCE AVAILABLE (TODA)– The takeoff run available plus the length of any remaining runway or clearway beyond the far end of the takeoff run available.

(See ICAO term TAKEOFF DISTANCE AVAILABLE.)

TAKEOFF DISTANCE AVAILABLE [ICAO]– The length of the takeoff run available plus the length of the clearway, if provided.

TAKEOFF HOLD LIGHTS (THL)– The THL system is composed of in-pavement lighting in a double, longitudinal row of lights aligned either side of the runway centerline. The lights are focused toward the arrival end of the runway at the “line up and wait” point, and they extend for 1,500 feet in front of the holding aircraft. Illuminated red lights indicate to an aircraft in position for takeoff or rolling that it is unsafe to takeoff because the runway is occupied or about to be occupied by an aircraft or vehicle.

TAKEOFF ROLL – The process whereby an aircraft is aligned with the runway centerline and the aircraft is moving with the intent to take off. For helicopters,

this pertains to the act of becoming airborne after departing a takeoff area.

TAKEOFF RUN AVAILABLE (TORA) – The runway length declared available and suitable for the ground run of an airplane taking off.

(See ICAO term TAKEOFF RUN AVAILABLE.)

TAKEOFF RUN AVAILABLE [ICAO]– The length of runway declared available and suitable for the ground run of an aeroplane take-off.

TARGET– The indication shown on an analog display resulting from a primary radar return or a radar beacon reply.

(See ASSOCIATED.)

(See DIGITAL TARGET.)

(See DIGITIZED RADAR TARGET.)

(See FUSED TARGET.)

(See PRIMARY RADAR TARGET.)

(See RADAR.)

(See SECONDARY RADAR TARGET.)

(See TARGET SYMBOL.)

(See ICAO term TARGET.)

(See UNASSOCIATED.)

TARGET [ICAO]– In radar:

a. Generally, any discrete object which reflects or retransmits energy back to the radar equipment.

b. Specifically, an object of radar search or surveillance.

TARGET RESOLUTION– A process to ensure that correlated radar targets do not touch. Target resolution must be applied as follows:

a. Between the edges of two primary targets or the edges of the ASR-9/11 primary target symbol.

b. Between the end of the beacon control slash and the edge of a primary target.

c. Between the ends of two beacon control slashes.

Note 1: Mandatory traffic advisories and safety alerts must be issued when this procedure is used.

Note 2: This procedure must not be used when utilizing mosaic radar systems or multi-sensor mode.

TARGET SYMBOL– A computer-generated indication shown on a radar display resulting from a primary radar return or a radar beacon reply.

TARMAC DELAY– The holding of an aircraft on the ground either before departure or after landing with no opportunity for its passengers to deplane.

TARMAC DELAY AIRCRAFT– An aircraft whose pilot-in-command has requested to taxi to the ramp, gate, or alternate deplaning area to comply with the Three-hour Tarmac Rule.

TARMAC DELAY REQUEST– A request by the pilot-in-command to taxi to the ramp, gate, or alternate deplaning location to comply with the Three-hour Tarmac Rule.

TAS–

(See **TERMINAL AUTOMATION SYSTEMS**.)

TAWS–

(See **TERRAIN AWARENESS WARNING SYSTEM**.)

TAXI– The movement of an airplane under its own power on the surface of an airport (14 CFR Section 135.100 [Note]). Also, it describes the surface movement of helicopters equipped with wheels.

(See **AIR TAXI**.)

(See **HOVER TAXI**.)

(Refer to 14 CFR Section 135.100.)

(Refer to **AIM**.)

TAXI PATTERNS– Patterns established to illustrate the desired flow of ground traffic for the different runways or airport areas available for use.

TCAS–

(See **TRAFFIC ALERT AND COLLISION AVOIDANCE SYSTEM**.)

TCH–

(See **THRESHOLD CROSSING HEIGHT**.)

TCLT–

(See **TENTATIVE CALCULATED LANDING TIME**.)

TDLS–

(See **TERMINAL DATA LINK SYSTEM**.)

TDZE–

(See **TOUCHDOWN ZONE ELEVATION**.)

TELEPHONE INFORMATION BRIEFING SERVICE– A continuous telephone recording of meteorological and/or aeronautical information.

(Refer to **AIM**.)

TEMPORARY FLIGHT RESTRICTION (TFR)– A TFR is a regulatory action issued by the FAA via the U.S. NOTAM System, under the authority of United States Code, Title 49. TFRs are issued within the sovereign airspace of the United States and its territories to restrict certain aircraft from operating within a defined area on a temporary basis to protect persons or property in the air or on the ground. While not all inclusive, TFRs may be issued for disaster or hazard situations such as: toxic gas leaks or spills, fumes from flammable agents, aircraft accident/incident sites, aviation or ground resources engaged in wildfire suppression, or aircraft relief activities following a disaster. TFRs may also be issued in support of VIP movements, for reasons of national security; or when determined necessary for the management of air traffic in the vicinity of aerial demonstrations or major sporting events. NAS users or other interested parties should contact a FSS for TFR information. Additionally, TFR information can be found in automated briefings, NOTAM publications, and on the internet at <http://www.faa.gov>. The FAA also distributes TFR information to aviation user groups for further dissemination.

TENTATIVE CALCULATED LANDING TIME (TCLT)– A projected time calculated for adapted vertex for each arrival aircraft based upon runway configuration, airport acceptance rate, airport arrival delay period, and other metered arrival aircraft. This time is either the VTA of the aircraft or the TCLT/ACLT of the previous aircraft plus the AAI, whichever is later. This time will be updated in response to an aircraft's progress and its current relationship to other arrivals.

TERMINAL AREA– A general term used to describe airspace in which approach control service or airport traffic control service is provided.

TERMINAL AREA FACILITY– A facility providing air traffic control service for arriving and departing IFR, VFR, Special VFR, and on occasion en route aircraft.

(See **APPROACH CONTROL FACILITY**.)

(See **TOWER**.)

TERMINAL AUTOMATION SYSTEMS (TAS)– TAS is used to identify the numerous automated tracking systems including ARTS IIE, ARTS IIIA, ARTS IIIE, STARS, and MEARTS.

TERMINAL DATA LINK SYSTEM (TDLS)– A system that provides Digital Automatic Terminal

Information Service (D-ATIS) both on a specified radio frequency and also, for subscribers, in a text message via data link to the cockpit or to a gate printer. TDLS also provides Pre-departure Clearances (PDC), at selected airports, to subscribers, through a service provider, in text to the cockpit or to a gate printer. In addition, TDLS will emulate the Flight Data Input/Output (FDIO) information within the control tower.

TERMINAL RADAR SERVICE AREA– Airspace surrounding designated airports wherein ATC provides radar vectoring, sequencing, and separation on a full-time basis for all IFR and participating VFR aircraft. The AIM contains an explanation of TRSA. TRSAs are depicted on VFR aeronautical charts. Pilot participation is urged but is not mandatory.

TERMINAL VFR RADAR SERVICE– A national program instituted to extend the terminal radar services provided instrument flight rules (IFR) aircraft to visual flight rules (VFR) aircraft. The program is divided into four types service referred to as basic radar service, terminal radar service area (TRSA) service, Class B service and Class C service. The type of service provided at a particular location is contained in the Chart Supplement U.S.

a. Basic Radar Service– These services are provided for VFR aircraft by all commissioned terminal radar facilities. Basic radar service includes safety alerts, traffic advisories, limited radar vectoring when requested by the pilot, and sequencing at locations where procedures have been established for this purpose and/or when covered by a letter of agreement. The purpose of this service is to adjust the flow of arriving IFR and VFR aircraft into the traffic pattern in a safe and orderly manner and to provide traffic advisories to departing VFR aircraft.

b. TRSA Service– This service provides, in addition to basic radar service, sequencing of all IFR and participating VFR aircraft to the primary airport and separation between all participating VFR aircraft. The purpose of this service is to provide separation between all participating VFR aircraft and all IFR aircraft operating within the area defined as a TRSA.

c. Class C Service– This service provides, in addition to basic radar service, approved separation between IFR and VFR aircraft, and sequencing of VFR aircraft, and sequencing of VFR arrivals to the primary airport.

d. Class B Service– This service provides, in addition to basic radar service, approved separation of aircraft based on IFR, VFR, and/or weight, and sequencing of VFR arrivals to the primary airport(s).

(See CONTROLLED AIRSPACE.)

(See TERMINAL RADAR SERVICE AREA.)

(Refer to AIM.)

(Refer to CHART SUPPLEMENT U.S.)

TERMINAL-VERY HIGH FREQUENCY OMNI-DIRECTIONAL RANGE STATION (TVOR)– A very high frequency terminal omnirange station located on or near an airport and used as an approach aid.

(See NAVIGATIONAL AID.)

(See VOR.)

TERRAIN AWARENESS WARNING SYSTEM (TAWS)– An on-board, terrain proximity alerting system providing the aircrew ‘Low Altitude warnings’ to allow immediate pilot action.

TERRAIN FOLLOWING– The flight of a military aircraft maintaining a constant AGL altitude above the terrain or the highest obstruction. The altitude of the aircraft will constantly change with the varying terrain and/or obstruction.

TETRAHEDRON– A device normally located on uncontrolled airports and used as a landing direction indicator. The small end of a tetrahedron points in the direction of landing. At controlled airports, the tetrahedron, if installed, should be disregarded because tower instructions supersede the indicator.

(See SEGMENTED CIRCLE.)

(Refer to AIM.)

TF–

(See TERRAIN FOLLOWING.)

THAT IS CORRECT– The understanding you have is right.

THREE-HOUR TARMAC RULE– Rule that relates to Department of Transportation (DOT) requirements placed on airlines when tarmac delays are anticipated to reach 3 hours.

360 OVERHEAD–

(See OVERHEAD MANEUVER.)

THRESHOLD– The beginning of that portion of the runway usable for landing.

(See AIRPORT LIGHTING.)

(See DISPLACED THRESHOLD.)

THRESHOLD CROSSING HEIGHT– The theoretical height above the runway threshold at

which the aircraft's glideslope antenna would be if the aircraft maintains the trajectory established by the mean ILS glideslope or the altitude at which the calculated glidepath of an RNAV or GPS approaches.

(See GLIDESLOPE.)

(See THRESHOLD.)

THRESHOLD LIGHTS–

(See AIRPORT LIGHTING.)

TIBS–

(See TELEPHONE INFORMATION BRIEFING SERVICE.)

TIE-IN FACILITY– The FSS primarily responsible for providing FSS services, including telecommunications services for landing facilities or navigational aids located within the boundaries of a flight plan area (FPA). Three-letter identifiers are assigned to each FSS/FPA and are annotated as tie-in facilities in the Chart Supplement U.S., the Alaska Supplement, the Pacific Supplement, and FAA Order JO 7350.9, Location Identifiers. Large consolidated FSS facilities may have many tie-in facilities or FSS sectors within one facility.

(See FLIGHT PLAN AREA.)

(See FLIGHT SERVICE STATION.)

TIME BASED FLOW MANAGEMENT (TBFM)–

The hardware, software, methods, processes, and initiatives to manage air traffic flows based on time to balance air traffic demand with system capacity, and support the management of PBN. This includes, but not limited to, Adjacent Center Metering (ACM), En Route Departure Capability (EDC), Ground-based Interval Management-Spacing (GIM-S), Integrated Departure/Arrival Capability (IDAC), Single Center Metering (SCM), Time-Based Metering (TBM), Time-Based Scheduling (TBS), and Extended/Coupled Metering.

TIME GROUP– Four digits representing the hour and minutes from the Coordinated Universal Time (UTC) clock. FAA uses UTC for all operations. The term “ZULU” may be used to denote UTC. The word “local” or the time zone equivalent shall be used to denote local when local time is given during radio and telephone communications. When written, a time zone designator is used to indicate local time; e.g., “0205M” (Mountain). The local time may be based on the 24-hour clock system. The day begins at 0000 and ends at 2359.

TIS–B–

(See TRAFFIC INFORMATION SERVICE–BROADCAST.)

TMPA–

(See TRAFFIC MANAGEMENT PROGRAM ALERT.)

TMU–

(See TRAFFIC MANAGEMENT UNIT.)

TODA–

(See TAKEOFF DISTANCE AVAILABLE.)

(See ICAO term TAKEOFF DISTANCE AVAILABLE.)

TOI–

(See TRACK OF INTEREST.)

TOP ALTITUDE– In reference to SID published altitude restrictions, the charted “maintain” altitude contained in the procedure description or assigned by ATC.

TORA–

(See TAKEOFF RUN AVAILABLE.)

(See ICAO term TAKEOFF RUN AVAILABLE.)

TORCHING– The burning of fuel at the end of an exhaust pipe or stack of a reciprocating aircraft engine, the result of an excessive richness in the fuel air mixture.

TOS–

(See TRAJECTORY OPTIONS SET)

TOTAL ESTIMATED ELAPSED TIME [ICAO]– For IFR flights, the estimated time required from takeoff to arrive over that designated point, defined by reference to navigation aids, from which it is intended that an instrument approach procedure will be commenced, or, if no navigation aid is associated with the destination aerodrome, to arrive over the destination aerodrome. For VFR flights, the estimated time required from takeoff to arrive over the destination aerodrome.

(See ICAO term ESTIMATED ELAPSED TIME.)

TOUCH-AND-GO– An operation by an aircraft that lands and departs on a runway without stopping or exiting the runway.

TOUCH-AND-GO LANDING–

(See TOUCH-AND-GO.)

TOUCHDOWN–

a. The point at which an aircraft first makes contact with the landing surface.

b. Concerning a precision radar approach (PAR), it is the point where the glide path intercepts the landing surface.

(See ICAO term TOUCHDOWN.)

TOUCHDOWN [ICAO]– The point where the nominal glide path intercepts the runway.

Note: Touchdown as defined above is only a datum and is not necessarily the actual point at which the aircraft will touch the runway.

TOUCHDOWN RVR–

(See VISIBILITY.)

TOUCHDOWN ZONE– The first 3,000 feet of the runway beginning at the threshold. The area is used for determination of Touchdown Zone Elevation in the development of straight-in landing minimums for instrument approaches.

(See ICAO term TOUCHDOWN ZONE.)

TOUCHDOWN ZONE [ICAO]– The portion of a runway, beyond the threshold, where it is intended landing aircraft first contact the runway.

TOUCHDOWN ZONE ELEVATION– The highest elevation in the first 3,000 feet of the landing surface. TDZE is indicated on the instrument approach procedure chart when straight-in landing minimums are authorized.

(See TOUCHDOWN ZONE.)

TOUCHDOWN ZONE LIGHTING–

(See AIRPORT LIGHTING.)

TOWER– A terminal facility that uses air/ground communications, visual signaling, and other devices to provide ATC services to aircraft operating in the vicinity of an airport or on the movement area. Authorizes aircraft to land or takeoff at the airport controlled by the tower or to transit the Class D airspace area regardless of flight plan or weather conditions (IFR or VFR). A tower may also provide approach control services (radar or nonradar).

(See AIRPORT TRAFFIC CONTROL SERVICE.)

(See APPROACH CONTROL FACILITY.)

(See APPROACH CONTROL SERVICE.)

(See MOVEMENT AREA.)

(See TOWER EN ROUTE CONTROL SERVICE.)

(See ICAO term AERODROME CONTROL TOWER.)

(Refer to AIM.)

TOWER EN ROUTE CONTROL SERVICE– The control of IFR en route traffic within delegated airspace between two or more adjacent approach control facilities. This service is designed to expedite traffic and reduce control and pilot communication requirements.

TOWER TO TOWER–

(See TOWER EN ROUTE CONTROL SERVICE.)

TRACEABLE PRESSURE STANDARD– The facility station pressure instrument, with certification/calibration traceable to the National Institute of Standards and Technology. Traceable pressure standards may be mercurial barometers, commissioned ASOS or dual transducer AWOS, or portable pressure standards or DASI.

TRACK– The actual flight path of an aircraft over the surface of the earth.

(See COURSE.)

(See FLIGHT PATH.)

(See ROUTE.)

(See ICAO term TRACK.)

TRACK [ICAO]– The projection on the earth's surface of the path of an aircraft, the direction of which path at any point is usually expressed in degrees from North (True, Magnetic, or Grid).

TRACK OF INTEREST (TOI)– Displayed data representing an airborne object that threatens or has the potential to threaten North America or National Security. Indicators may include, but are not limited to: noncompliance with air traffic control instructions or aviation regulations; extended loss of communications; unusual transmissions or unusual flight behavior; unauthorized intrusion into controlled airspace or an ADIZ; noncompliance with issued flight restrictions/security procedures; or unlawful interference with airborne flight crews, up to and including hijack. In certain circumstances, an object may become a TOI based on specific and credible intelligence pertaining to that particular aircraft/object, its passengers, or its cargo.

TRACK OF INTEREST RESOLUTION– A TOI will normally be considered resolved when: the aircraft/object is no longer airborne; the aircraft complies with air traffic control instructions, aviation regulations, and/or issued flight restrictions/security procedures; radio contact is re-established and authorized control of the aircraft is verified; the aircraft is intercepted and intent is verified to be

nonthreatening/nonhostile; TOI was identified based on specific and credible intelligence that was later determined to be invalid or unreliable; or displayed data is identified and characterized as invalid.

TRAFFIC-

a. A term used by a controller to transfer radar identification of an aircraft to another controller for the purpose of coordinating separation action. Traffic is normally issued:

1. In response to a handoff or point out,
2. In anticipation of a handoff or point out, or
3. In conjunction with a request for control of an aircraft.

b. A term used by ATC to refer to one or more aircraft.

TRAFFIC ADVISORIES- Advisories issued to alert pilots to other known or observed air traffic which may be in such proximity to the position or intended route of flight of their aircraft to warrant their attention. Such advisories may be based on:

- a.** Visual observation.
- b.** Observation of radar identified and nonidentified aircraft targets on an ATC radar display, or
- c.** Verbal reports from pilots or other facilities.

Note 1: The word "traffic" followed by additional information, if known, is used to provide such advisories; e.g., "Traffic, 2 o'clock, one zero miles, southbound, eight thousand."

Note 2: Traffic advisory service will be provided to the extent possible depending on higher priority duties of the controller or other limitations; e.g., radar limitations, volume of traffic, frequency congestion, or controller workload. Radar/nonradar traffic advisories do not relieve the pilot of his/her responsibility to see and avoid other aircraft. Pilots are cautioned that there are many times when the controller is not able to give traffic advisories concerning all traffic in the aircraft's proximity; in other words, when a pilot requests or is receiving traffic advisories, he/she should not assume that all traffic will be issued.

(Refer to AIM.)

TRAFFIC ALERT (*aircraft call sign*), **TURN** (*left/right*) **IMMEDIATELY**, (*climb/descend*) **AND MAINTAIN** (*altitude*).

(See SAFETY ALERT.)

TRAFFIC ALERT AND COLLISION AVOIDANCE SYSTEM (TCAS)- An airborne collision

avoidance system based on radar beacon signals which operates independent of ground-based equipment. TCAS-I generates traffic advisories only. TCAS-II generates traffic advisories, and resolution (collision avoidance) advisories in the vertical plane.

TRAFFIC INFORMATION-

(See TRAFFIC ADVISORIES.)

TRAFFIC INFORMATION SERVICE-BROADCAST (TIS-B)- The broadcast of ATC derived traffic information to ADS-B equipped (1090ES or UAT) aircraft. The source of this traffic information is derived from ground-based air traffic surveillance sensors, typically from radar targets. TIS-B service will be available throughout the NAS where there are both adequate surveillance coverage (radar) and adequate broadcast coverage from ADS-B ground stations. Loss of TIS-B will occur when an aircraft enters an area not covered by the GBT network. If this occurs in an area with adequate surveillance coverage (radar), nearby aircraft that remain within the adequate broadcast coverage (ADS-B) area will view the first aircraft. TIS-B may continue when an aircraft enters an area with inadequate surveillance coverage (radar); nearby aircraft that remain within the adequate broadcast coverage (ADS-B) area will not view the first aircraft.

TRAFFIC IN SIGHT- Used by pilots to inform a controller that previously issued traffic is in sight.

(See NEGATIVE CONTACT.)

(See TRAFFIC ADVISORIES.)

TRAFFIC MANAGEMENT PROGRAM ALERT- A term used in a Notice to Airmen (NOTAM) issued in conjunction with a special traffic management program to alert pilots to the existence of the program and to refer them to either the Notices to Airmen publication or a special traffic management program advisory message for program details. The contraction TMPA is used in NOTAM text.

TRAFFIC MANAGEMENT UNIT- The entity in ARTCCs and designated terminals directly involved in the active management of facility traffic. Usually under the direct supervision of an assistant manager for traffic management.

TRAFFIC NO FACTOR- Indicates that the traffic described in a previously issued traffic advisory is no factor.

TRAFFIC NO LONGER OBSERVED- Indicates that the traffic described in a previously issued traffic

advisory is no longer depicted on radar, but may still be a factor.

TRAFFIC PATTERN– The traffic flow that is prescribed for aircraft landing at, taxiing on, or taking off from an airport. The components of a typical traffic pattern are upwind leg, crosswind leg, downwind leg, base leg, and final approach.

a. Upwind Leg– A flight path parallel to the landing runway in the direction of landing.

b. Crosswind Leg– A flight path at right angles to the landing runway off its upwind end.

c. Downwind Leg– A flight path parallel to the landing runway in the direction opposite to landing. The downwind leg normally extends between the crosswind leg and the base leg.

d. Base Leg– A flight path at right angles to the landing runway off its approach end. The base leg normally extends from the downwind leg to the intersection of the extended runway centerline.

e. Final Approach– A flight path in the direction of landing along the extended runway centerline. The final approach normally extends from the base leg to the runway. An aircraft making a straight-in approach VFR is also considered to be on final approach.

(See **STRAIGHT-IN APPROACH VFR**.)

(See **TAXI PATTERNS**.)

(See ICAO term **AERODROME TRAFFIC CIRCUIT**.)

(Refer to 14 CFR Part 91.)

(Refer to **AIM**.)

TRAFFIC SITUATION DISPLAY (TSD)– TSD is a computer system that receives radar track data from all 20 CONUS ARTCCs, organizes this data into a mosaic display, and presents it on a computer screen. The display allows the traffic management coordinator multiple methods of selection and highlighting of individual aircraft or groups of aircraft. The user has the option of superimposing these aircraft positions over any number of background displays. These background options include ARTCC boundaries, any stratum of en route sector boundaries, fixes, airways, military and other special use airspace, airports, and geopolitical boundaries. By using the TSD, a coordinator can monitor any number of traffic situations or the entire systemwide traffic flows.

TRAJECTORY– A EDST representation of the path an aircraft is predicted to fly based upon a Current Plan or Trial Plan.

(See **EN ROUTE DECISION SUPPORT TOOL**.)

TRAJECTORY MODELING– The automated process of calculating a trajectory.

TRAJECTORY OPTIONS SET (TOS)– A TOS is an electronic message, submitted by the operator, that is used by the Collaborative Trajectory Options Program (CTOP) to manage the airspace captured in the traffic management program. The TOS will allow the operator to express the route and delay trade-off options that they are willing to accept.

TRANSCRIBED WEATHER BROADCAST (TWEB)– A continuous recording of meteorological and aeronautical information that is broadcast on L/MF and VOR facilities for pilots. (Provided only in Alaska.)

(Refer to **AIM**.)

TRANSFER OF CONTROL– That action whereby the responsibility for the separation of an aircraft is transferred from one controller to another.

(See ICAO term **TRANSFER OF CONTROL**.)

TRANSFER OF CONTROL [ICAO]– Transfer of responsibility for providing air traffic control service.

TRANSFERRING CONTROLLER– A controller/facility transferring control of an aircraft to another controller/facility.

(See ICAO term **TRANSFERRING UNIT/CONTROLLER**.)

TRANSFERRING FACILITY–

(See **TRANSFERRING CONTROLLER**.)

TRANSFERRING UNIT/CONTROLLER [ICAO]– Air traffic control unit/air traffic controller in the process of transferring the responsibility for providing air traffic control service to an aircraft to the next air traffic control unit/air traffic controller along the route of flight.

Note: See definition of accepting unit/controller.

TRANSITION–

a. The general term that describes the change from one phase of flight or flight condition to another; e.g., transition from en route flight to the approach or transition from instrument flight to visual flight.

b. A published procedure (DP Transition) used to connect the basic DP to one of several en route

airways/jet routes, or a published procedure (STAR Transition) used to connect one of several en route airways/jet routes to the basic STAR.

(Refer to DP/STAR Charts.)

TRANSITION POINT– A point at an adapted number of miles from the vertex at which an arrival aircraft would normally commence descent from its en route altitude. This is the first fix adapted on the arrival speed segments.

TRANSITION WAYPOINT– The waypoint that defines the beginning of a runway or en route transition on an RNAV SID or STAR.

TRANSITIONAL AIRSPACE– That portion of controlled airspace wherein aircraft change from one phase of flight or flight condition to another.

TRANSMISSOMETER– An apparatus used to determine visibility by measuring the transmission of light through the atmosphere. It is the measurement source for determining runway visual range (RVR) and runway visibility value (RVV).

(See VISIBILITY.)

TRANSMITTING IN THE BLIND– A transmission from one station to other stations in circumstances where two-way communication cannot be established, but where it is believed that the called stations may be able to receive the transmission.

TRANSPONDER– The airborne radar beacon receiver/transmitter portion of the Air Traffic Control Radar Beacon System (ATCRBS) which automatically receives radio signals from interrogators on the ground, and selectively replies with a specific reply pulse or pulse group only to those interrogations being received on the mode to which it is set to respond.

(See INTERROGATOR.)

(See ICAO term TRANSPONDER.)

(Refer to AIM.)

TRANSPONDER [ICAO]– A receiver/transmitter which will generate a reply signal upon proper interrogation; the interrogation and reply being on different frequencies.

TRANSPONDER CODES–

(See CODES.)

TRANSPONDER OBSERVED – Phraseology used to inform a VFR pilot the aircraft's assigned beacon code and position have been observed. Specifically, this term conveys to a VFR pilot the transponder reply has been observed and its position correlated for transit through the designated area.

TRIAL PLAN– A proposed amendment which utilizes automation to analyze and display potential conflicts along the predicted trajectory of the selected aircraft.

TRSA–

(See TERMINAL RADAR SERVICE AREA.)

TSD–

(See TRAFFIC SITUATION DISPLAY.)

TURBOJET AIRCRAFT– An aircraft having a jet engine in which the energy of the jet operates a turbine which in turn operates the air compressor.

TURBOPROP AIRCRAFT– An aircraft having a jet engine in which the energy of the jet operates a turbine which drives the propeller.

TURBULENCE– An atmospheric phenomenon that causes changes in aircraft altitude, attitude, and or airspeed with aircraft reaction depending on intensity. Pilots report turbulence intensity according to aircraft's reaction as follows:

a. Light – Causes slight, erratic changes in altitude and or attitude (pitch, roll, or yaw).

b. Moderate– Similar to Light but of greater intensity. Changes in altitude and or attitude occur but the aircraft remains in positive control at all times. It usually causes variations in indicated airspeed.

c. Severe– Causes large, abrupt changes in altitude and or attitude. It usually causes large variations in indicated airspeed. Aircraft may be momentarily out of control.

d. Extreme– The aircraft is violently tossed about and is practically impossible to control. It may cause structural damage.

(See CHOP.)

(Refer to AIM.)

TURN ANTICIPATION– (maneuver anticipation).

TVOR–

(See TERMINAL-VERY HIGH FREQUENCY OMNIDIRECTIONAL RANGE STATION.)

TWEB–

(See TRANSCRIBED WEATHER BROADCAST.)

TWO-WAY RADIO COMMUNICATIONS FAILURE-
(See LOST COMMUNICATIONS.)

U

UHF–

(See ULTRAHIGH FREQUENCY.)

ULTRAHIGH FREQUENCY (UHF)– The frequency band between 300 and 3,000 MHz. The bank of radio frequencies used for military air/ground voice communications. In some instances this may go as low as 225 MHz and still be referred to as UHF.

ULTRALIGHT VEHICLE– A single-occupant aeronautical vehicle operated for sport or recreational purposes which does not require FAA registration, an airworthiness certificate, or pilot certification. Operation of an ultralight vehicle in certain airspace requires authorization from ATC.

(Refer to 14 CFR Part 103.)

UNABLE– Indicates inability to comply with a specific instruction, request, or clearance.

UNASSOCIATED– A radar target that does not display a data block with flight identification and altitude information.

(See ASSOCIATED.)

UNCONTROLLED AIRSPACE– Airspace in which aircraft are not subject to controlled airspace (Class A, B, C, D, or E) separation criteria.

UNDER THE HOOD– Indicates that the pilot is using a hood to restrict visibility outside the cockpit while simulating instrument flight. An appropriately rated pilot is required in the other control seat while this operation is being conducted.

(Refer to 14 CFR Part 91.)

UNFROZEN– The Scheduled Time of Arrival (STA) tags, which are still being rescheduled by the time based flow management (TBFM) calculations. The aircraft will remain unfrozen until the time the corresponding estimated time of arrival (ETA) tag passes the preset freeze horizon for that aircraft's stream class. At this point the automatic rescheduling will stop, and the STA becomes "frozen."

UNICOM– A nongovernment communication facility which may provide airport information at certain airports. Locations and frequencies of UNICOMs are shown on aeronautical charts and publications.

(See CHART SUPPLEMENT U.S.)

(Refer to AIM.)

UNMANNED AIRCRAFT (UA)– A device used or intended to be used for flight that has no onboard pilot. This device can be any type of airplane, helicopter, airship, or powered-lift aircraft. Unmanned free balloons, moored balloons, tethered aircraft, gliders, and unmanned rockets are not considered to be a UA.

UNMANNED AIRCRAFT SYSTEM (UAS)– An unmanned aircraft and its associated elements related to safe operations, which may include control stations (ground, ship, or air based), control links, support equipment, payloads, flight termination systems, and launch/recovery equipment. It consists of three elements: unmanned aircraft, control station, and data link.

UNPUBLISHED ROUTE– A route for which no minimum altitude is published or charted for pilot use. It may include a direct route between NAVAIDS, a radial, a radar vector, or a final approach course beyond the segments of an instrument approach procedure.

(See PUBLISHED ROUTE.)

(See ROUTE.)

UNRELIABLE (GPS/WAAS)– An advisory to pilots indicating the expected level of service of the GPS and/or WAAS may not be available. Pilots must then determine the adequacy of the signal for desired use.

UPWIND LEG–

(See TRAFFIC PATTERN.)

URGENCY– A condition of being concerned about safety and of requiring timely but not immediate assistance; a potential distress condition.

(See ICAO term URGENCY.)

URGENCY [ICAO]– A condition concerning the safety of an aircraft or other vehicle, or of person on board or in sight, but which does not require immediate assistance.

USAFIB–

(See ARMY AVIATION FLIGHT INFORMATION BULLETIN.)

V

VASI–

(See VISUAL APPROACH SLOPE INDICATOR.)

VCOA–

(See VISUAL CLIMB OVER AIRPORT.)

VDP–

(See VISUAL DESCENT POINT.)

VECTOR– A heading issued to an aircraft to provide navigational guidance by radar.

(See ICAO term RADAR VECTORING.)

VERIFY– Request confirmation of information; e.g., “verify assigned altitude.”

VERIFY SPECIFIC DIRECTION OF TAKEOFF (OR TURNS AFTER TAKEOFF)– Used by ATC to ascertain an aircraft’s direction of takeoff and/or direction of turn after takeoff. It is normally used for IFR departures from an airport not having a control tower. When direct communication with the pilot is not possible, the request and information may be relayed through an FSS, dispatcher, or by other means.

(See IFR TAKEOFF MINIMUMS AND DEPARTURE PROCEDURES.)

VERTEX– The last fix adapted on the arrival speed segments. Normally, it will be the outer marker of the runway in use. However, it may be the actual threshold or other suitable common point on the approach path for the particular runway configuration.

VERTEX TIME OF ARRIVAL– A calculated time of aircraft arrival over the adapted vertex for the runway configuration in use. The time is calculated via the optimum flight path using adapted speed segments.

VERTICAL NAVIGATION (VNAV)– A function of area navigation (RNAV) equipment which calculates, displays, and provides vertical guidance to a profile or path.

VERTICAL SEPARATION– Separation between aircraft expressed in units of vertical distance.

(See SEPARATION.)

VERTICAL TAKEOFF AND LANDING AIRCRAFT (VTOL)– Aircraft capable of vertical climbs

and/or descents and of using very short runways or small areas for takeoff and landings. These aircraft include, but are not limited to, helicopters.

(See SHORT TAKEOFF AND LANDING AIRCRAFT.)

VERY HIGH FREQUENCY (VHF)– The frequency band between 30 and 300 MHz. Portions of this band, 108 to 118 MHz, are used for certain NAVAIDs; 118 to 136 MHz are used for civil air/ground voice communications. Other frequencies in this band are used for purposes not related to air traffic control.

VERY HIGH FREQUENCY OMNIDIRECTIONAL RANGE STATION–

(See VOR.)

VERY LOW FREQUENCY (VLF)– The frequency band between 3 and 30 kHz.

VFR–

(See VISUAL FLIGHT RULES.)

VFR AIRCRAFT– An aircraft conducting flight in accordance with visual flight rules.

(See VISUAL FLIGHT RULES.)

VFR CONDITIONS– Weather conditions equal to or better than the minimum for flight under visual flight rules. The term may be used as an ATC clearance/instruction only when:

a. An IFR aircraft requests a climb/descent in VFR conditions.

b. The clearance will result in noise abatement benefits where part of the IFR departure route does not conform to an FAA approved noise abatement route or altitude.

c. A pilot has requested a practice instrument approach and is not on an IFR flight plan.

Note: All pilots receiving this authorization must comply with the VFR visibility and distance from cloud criteria in 14 CFR Part 91. Use of the term does not relieve controllers of their responsibility to separate aircraft in Class B and Class C airspace or TRSAs as required by FAA Order JO 7110.65. When used as an ATC clearance/instruction, the term may be abbreviated “VFR;” e.g., “MAINTAIN VFR,” “CLIMB/DESCEND VFR,” etc.

VFR FLIGHT–

(See VFR AIRCRAFT.)

VFR MILITARY TRAINING ROUTES (VR)– Routes used by the Department of Defense and associated Reserve and Air Guard units for the purpose of conducting low-altitude navigation and tactical training under VFR below 10,000 feet MSL at airspeeds in excess of 250 knots IAS.

VFR NOT RECOMMENDED– An advisory provided by a flight service station to a pilot during a preflight or inflight weather briefing that flight under visual flight rules is not recommended. To be given when the current and/or forecast weather conditions are at or below VFR minimums. It does not abrogate the pilot's authority to make his/her own decision.

VFR-ON-TOP– ATC authorization for an IFR aircraft to operate in VFR conditions at any appropriate VFR altitude (as specified in 14 CFR and as restricted by ATC). A pilot receiving this authorization must comply with the VFR visibility, distance from cloud criteria, and the minimum IFR altitudes specified in 14 CFR Part 91. The use of this term does not relieve controllers of their responsibility to separate aircraft in Class B and Class C airspace or TRSAs as required by FAA Order JO 7110.65.

VFR TERMINAL AREA CHARTS–
(See AERONAUTICAL CHART.)

VFR WAYPOINT–
(See WAYPOINT.)

VHF–
(See VERY HIGH FREQUENCY.)

VHF OMNIDIRECTIONAL RANGE/TACTICAL AIR NAVIGATION–
(See VORTAC.)

VIDEO MAP– An electronically displayed map on the radar display that may depict data such as airports, heliports, runway centerline extensions, hospital emergency landing areas, NAVAIDs and fixes, reporting points, airway/route centerlines, boundaries, handoff points, special use tracks, obstructions, prominent geographic features, map alignment indicators, range accuracy marks, and/or minimum vectoring altitudes.

VISIBILITY– The ability, as determined by atmospheric conditions and expressed in units of

distance, to see and identify prominent unlighted objects by day and prominent lighted objects by night. Visibility is reported as statute miles, hundreds of feet or meters.

(Refer to 14 CFR Part 91.)

(Refer to AIM.)

a. Flight Visibility– The average forward horizontal distance, from the cockpit of an aircraft in flight, at which prominent unlighted objects may be seen and identified by day and prominent lighted objects may be seen and identified by night.

b. Ground Visibility– Prevailing horizontal visibility near the earth's surface as reported by the United States National Weather Service or an accredited observer.

c. Prevailing Visibility– The greatest horizontal visibility equaled or exceeded throughout at least half the horizon circle which need not necessarily be continuous.

d. Runway Visibility Value (RVV)– The visibility determined for a particular runway by a transmissometer. A meter provides a continuous indication of the visibility (reported in miles or fractions of miles) for the runway. RVV is used in lieu of prevailing visibility in determining minimums for a particular runway.

e. Runway Visual Range (RVR)– An instrumentally derived value, based on standard calibrations, that represents the horizontal distance a pilot will see down the runway from the approach end. It is based on the sighting of either high intensity runway lights or on the visual contrast of other targets whichever yields the greater visual range. RVR, in contrast to prevailing or runway visibility, is based on what a pilot in a moving aircraft should see looking down the runway. RVR is horizontal visual range, not slant visual range. It is based on the measurement of a transmissometer made near the touchdown point of the instrument runway and is reported in hundreds of feet. RVR is used in lieu of RVV and/or prevailing visibility in determining minimums for a particular runway.

1. Touchdown RVR– The RVR visibility readout values obtained from RVR equipment serving the runway touchdown zone.

2. Mid-RVR– The RVR readout values obtained from RVR equipment located midfield of the runway.

3. Rollout RVR– The RVR readout values obtained from RVR equipment located nearest the rollout end of the runway.

(See ICAO term FLIGHT VISIBILITY.)

(See ICAO term GROUND VISIBILITY.)

(See ICAO term RUNWAY VISUAL RANGE.)

(See ICAO term VISIBILITY.)

VISIBILITY [ICAO]– The ability, as determined by atmospheric conditions and expressed in units of distance, to see and identify prominent unlighted objects by day and prominent lighted objects by night.

a. Flight Visibility– The visibility forward from the cockpit of an aircraft in flight.

b. Ground Visibility– The visibility at an aerodrome as reported by an accredited observer.

c. Runway Visual Range [RVR]– The range over which the pilot of an aircraft on the centerline of a runway can see the runway surface markings or the lights delineating the runway or identifying its centerline.

VISUAL APPROACH– An approach conducted on an instrument flight rules (IFR) flight plan which authorizes the pilot to proceed visually and clear of clouds to the airport. The pilot must, at all times, have either the airport or the preceding aircraft in sight. This approach must be authorized and under the control of the appropriate air traffic control facility. Reported weather at the airport must be: ceiling at or above 1,000 feet, and visibility of 3 miles or greater.

(See ICAO term VISUAL APPROACH.)

VISUAL APPROACH [ICAO]– An approach by an IFR flight when either part or all of an instrument approach procedure is not completed and the approach is executed in visual reference to terrain.

VISUAL APPROACH SLOPE INDICATOR (VASI)–

(See AIRPORT LIGHTING.)

VISUAL CLIMB OVER AIRPORT (VCOA)– A departure option for an IFR aircraft, operating in visual meteorological conditions equal to or greater than the specified visibility and ceiling, to visually conduct climbing turns over the airport to the published “climb-to” altitude from which to proceed with the instrument portion of the departure. VCOA procedures are developed to avoid obstacles greater than 3 statute miles from the departure end of the

runway as an alternative to complying with climb gradients greater than 200 feet per nautical mile. Pilots are responsible to advise ATC as early as possible of the intent to fly the VCOA option prior to departure. These textual procedures are published in the ‘Take-Off Minimums and (Obstacle) Departure Procedures’ section of the Terminal Procedures Publications and/or appear as an option on a Graphic ODP.

(See AIM.)

VISUAL DESCENT POINT– A defined point on the final approach course of a nonprecision straight-in approach procedure from which normal descent from the MDA to the runway touchdown point may be commenced, provided the approach threshold of that runway, or approach lights, or other markings identifiable with the approach end of that runway are clearly visible to the pilot.

VISUAL FLIGHT RULES– Rules that govern the procedures for conducting flight under visual conditions. The term “VFR” is also used in the United States to indicate weather conditions that are equal to or greater than minimum VFR requirements. In addition, it is used by pilots and controllers to indicate type of flight plan.

(See INSTRUMENT FLIGHT RULES.)

(See INSTRUMENT METEOROLOGICAL CONDITIONS.)

(See VISUAL METEOROLOGICAL CONDITIONS.)

(Refer to 14 CFR Part 91.)

(Refer to AIM.)

VISUAL HOLDING– The holding of aircraft at selected, prominent geographical fixes which can be easily recognized from the air.

(See HOLDING FIX.)

VISUAL METEOROLOGICAL CONDITIONS– Meteorological conditions expressed in terms of visibility, distance from cloud, and ceiling equal to or better than specified minima.

(See INSTRUMENT FLIGHT RULES.)

(See INSTRUMENT METEOROLOGICAL CONDITIONS.)

(See VISUAL FLIGHT RULES.)

VISUAL SEGMENT–

(See PUBLISHED INSTRUMENT APPROACH PROCEDURE VISUAL SEGMENT.)

VISUAL SEPARATION– A means employed by ATC to separate aircraft in terminal areas and en route airspace in the NAS. There are two ways to effect this separation:

a. The tower controller sees the aircraft involved and issues instructions, as necessary, to ensure that the aircraft avoid each other.

b. A pilot sees the other aircraft involved and upon instructions from the controller provides his/her own separation by maneuvering his/her aircraft as necessary to avoid it. This may involve following another aircraft or keeping it in sight until it is no longer a factor.

(See SEE AND AVOID.)

(Refer to 14 CFR Part 91.)

VLF–

(See VERY LOW FREQUENCY.)

VMC–

(See VISUAL METEOROLOGICAL CONDITIONS.)

VOICE SWITCHING AND CONTROL SYSTEM (VSCS)– A computer controlled switching system that provides air traffic controllers with all voice circuits (air to ground and ground to ground) necessary for air traffic control.

(Refer to AIM.)

VOR– A ground-based electronic navigation aid transmitting very high frequency navigation signals, 360 degrees in azimuth, oriented from magnetic north. Used as the basis for navigation in the National Airspace System. The VOR periodically identifies itself by Morse Code and may have an additional voice identification feature. Voice features may be used by ATC or FSS for transmitting instructions/information to pilots.

(See NAVIGATIONAL AID.)

(Refer to AIM.)

VOR TEST SIGNAL–

(See VOT.)

VORTAC– A navigation aid providing VOR azimuth, TACAN azimuth, and TACAN distance measuring equipment (DME) at one site.

(See DISTANCE MEASURING EQUIPMENT.)

(See NAVIGATIONAL AID.)

(See TACAN.)

(See VOR.)

(Refer to AIM.)

VORTICES– Circular patterns of air created by the movement of an airfoil through the air when generating lift. As an airfoil moves through the atmosphere in sustained flight, an area of low pressure is created above it. The air flowing from the high pressure area to the low pressure area around and about the tips of the airfoil tends to roll up into two rapidly rotating vortices, cylindrical in shape. These vortices are the most predominant parts of aircraft wake turbulence and their rotational force is dependent upon the wing loading, gross weight, and speed of the generating aircraft. The vortices from medium to super aircraft can be of extremely high velocity and hazardous to smaller aircraft.

(See AIRCRAFT CLASSES.)

(See WAKE TURBULENCE.)

(Refer to AIM.)

VOT– A ground facility which emits a test signal to check VOR receiver accuracy. Some VOTs are available to the user while airborne, and others are limited to ground use only.

(See CHART SUPPLEMENT U.S.)

(Refer to 14 CFR Part 91.)

(Refer to AIM.)

VR–

(See VFR MILITARY TRAINING ROUTES.)

VSCS–

(See VOICE SWITCHING AND CONTROL SYSTEM.)

VTA–

(See VERTEX TIME OF ARRIVAL.)

VTOL AIRCRAFT–

(See VERTICAL TAKEOFF AND LANDING AIRCRAFT.)

W

WA–

(See AIRMET.)

(See WEATHER ADVISORY.)

WAAS–

(See WIDE-AREA AUGMENTATION SYSTEM.)

WAKE TURBULENCE– A phenomenon that occurs when an aircraft develops lift and forms a pair of counter-rotating vortices.

(See AIRCRAFT CLASSES.)

(See VORTICES.)

(Refer to AIM.)

WARNING AREA–

(See SPECIAL USE AIRSPACE.)

WAYPOINT– A predetermined geographical position used for route/instrument approach definition, progress reports, published VFR routes, visual reporting points or points for transitioning and/or circumnavigating controlled and/or special use airspace, that is defined relative to a VORTAC station or in terms of latitude/longitude coordinates.

WEATHER ADVISORY– In aviation weather forecast practice, an expression of hazardous weather conditions not predicted in the Aviation Surface Forecast, Aviation Cloud Forecast, or area forecast, as they affect the operation of air traffic and as prepared by the NWS.

(See AIRMET.)

(See SIGMET.)

WEATHER RECONNAISSANCE AREA (WRA)– A WRA is airspace with defined dimensions and published by Notice to Airmen, which is established to support weather reconnaissance/research flights. Air traffic control services are not provided within WRAs. Only participating weather reconnaissance/research aircraft from the 53rd Weather Reconnaissance Squadron and National Oceanic and Atmospheric Administration Aircraft Operations Center are permitted to operate within a WRA. A WRA may only be established in airspace within U.S. Flight Information Regions outside of U.S. territorial airspace.

WHEN ABLE–

a. In conjunction with ATC instructions, gives the pilot the latitude to delay compliance until a condition or event has been reconciled. Unlike “pilot discretion,” when instructions are prefaced “when able,” the pilot is expected to seek the first opportunity to comply.

b. In conjunction with a weather deviation clearance, requires the pilot to determine when he/she is clear of weather, then execute ATC instructions.

c. Once a maneuver has been initiated, the pilot is expected to continue until the specifications of the instructions have been met. “When able,” should not be used when expeditious compliance is required.

WIDE-AREA AUGMENTATION SYSTEM (WAAS)– The WAAS is a satellite navigation system consisting of the equipment and software which augments the GPS Standard Positioning Service (SPS). The WAAS provides enhanced integrity, accuracy, availability, and continuity over and above GPS SPS. The differential correction function provides improved accuracy required for precision approach.

WIDE AREA MULTILATERATION (WAM)– A distributed surveillance technology which may utilize any combination of signals from Air Traffic Control Radar Beacon System (ATCRBS) (Modes A and C) and Mode S transponders, and ADS-B transmissions. Multiple geographically dispersed ground sensors measure the time-of-arrival of the transponder messages. Aircraft position is determined by joint processing of the time-difference-of-arrival (TDOA) measurements computed between a reference and the ground stations’ measured time-of-arrival.

WILCO– I have received your message, understand it, and will comply with it.

WIND GRID DISPLAY– A display that presents the latest forecasted wind data overlaid on a map of the ARTCC area. Wind data is automatically entered and updated periodically by transmissions from the National Weather Service. Winds at specific altitudes, along with temperatures and air pressure can be viewed.

WIND SHEAR– A change in wind speed and/or wind direction in a short distance resulting in a tearing or

shearing effect. It can exist in a horizontal or vertical direction and occasionally in both.

WIND SHEAR ESCAPE– An unplanned abortive maneuver initiated by the pilot in command (PIC) as a result of onboard cockpit systems. Wind shear escapes are characterized by maximum thrust climbs in the low altitude terminal environment until wind shear conditions are no longer detected.

WING TIP VORTICES–
(See VORTICES.)

WORDS TWICE–

a. As a request: “Communication is difficult. Please say every phrase twice.”

b. As information: “Since communications are difficult, every phrase in this message will be spoken twice.”

WS–
(See SIGMET.)
(See WEATHER ADVISORY.)

WST–
(See CONVECTIVE SIGMET.)
(See WEATHER ADVISORY.)

INDEX

[References are to page numbers]

A

- Accident, Aircraft, Reporting, 7-6-1
- Accident Cause Factors, 7-5-1
- Adherence to Clearance, 4-4-5
- ADS-B. *See* Automatic Dependent Broadcast Services
- ADS-R. *See* Automatic Dependent Surveillance-Rebroadcast
- Advisories
 - Braking Action, 4-3-13
 - Inflight Aviation Weather, 7-1-9
 - Minimum Fuel, 5-5-7
 - Traffic, 5-5-5
- Aerobatic Flight, 8-1-8
- Aerodrome Forecast (TAF), 7-1-68, 7-1-69, 7-1-70
- Aeronautical
 - Charts, 9-1-1
 - Publications, 9-1-1
- Aeronautical Light Beacons, 2-2-1
- AFIS. *See* Automatic Flight Information Service
- AHRS. *See* Attitude Heading Reference System
- Air Ambulance Flights, 4-2-4
- Air Defense Identification Zones, 5-6-13
- Air Route Surveillance Radar, 4-5-7
- Air Route Traffic Control Centers, 4-1-1
- Air Traffic Control
 - Aircraft Separation, 4-4-1
 - Clearances, 4-4-1
 - Pilot Services, 4-1-1
 - Air Route Traffic Control Centers, 4-1-1
 - Airport Reservations, 4-1-18
 - Approach Control Service, Arriving VFR Aircraft, 4-1-2
 - Automatic Terminal Information Service, 4-1-7
 - Communications, Release of IFR Aircraft, Airports without Operating Control Tower, 4-1-1
 - Control Towers, 4-1-1
 - Flight Service Stations, 4-1-1
 - Ground Vehicle Operations, 4-1-6
 - IFR Approaches, 4-1-6
 - Operation Rain Check, 4-1-1
 - Radar Assistance to VFR Aircraft, 4-1-11
 - Radar Traffic Information Service, 4-1-9
 - Recording and Monitoring, 4-1-1
 - Safety Alert, 4-1-10
 - Terminal Radar Services for VFR Aircraft, 4-1-12
 - Tower En Route Control, 4-1-14
 - Traffic Advisory Practices, Airports Without Operating Control Towers, 4-1-2
 - Transponder Operation, 4-1-15
 - Unicom, Use for ATC Purposes, 4-1-7
 - Unicom/Multicom, 4-1-6
- Air Traffic Control Radar Beacon System, 4-1-15, 4-5-2
- Aircraft
 - Arresting Devices, 2-3-30
 - Call Signs, 4-2-3
 - Lights, Use in Airport Operations, 4-3-27
 - Unmanned, 7-5-2
 - VFR, Emergency Radar Service, 6-2-1
- Aircraft Conflict Alert, 4-1-11
- Airport
 - Aids, Marking, 2-3-1
 - Holding Position, 2-3-12
 - Pavement, 2-3-1
 - Holding Position, 2-3-1
 - Other, 2-3-1
 - Runway, 2-3-1
 - Taxiway, 2-3-1
 - Airport Advisory/Information Services, 3-5-1
 - Lighting Aids, 2-1-1
 - Local Airport Advisory (LAA), 4-1-4
 - Operations, 4-3-1
 - Communications, 4-3-20
 - Exiting the Runway, After Landing, 4-3-25
 - Flight Check Aircraft, In Terminal Areas, 4-3-28
 - Flight Inspection, 4-3-28
 - Gate Holding, Departure Delays, 4-3-21
 - Intersection Takeoffs, 4-3-16
 - Low Approach, 4-3-19
 - Low Level Wind Shear/Microburst Detection Systems, 4-3-13
 - Option Approach, 4-3-26
 - Signals, Hand, 4-3-28
 - Taxi During Low Visibility, 4-3-24
 - Traffic Control Light Signals, 4-3-19
 - Traffic Patterns, 4-3-1, 4-3-2
 - Use of Aircraft Lights, 4-3-27
 - Use of Runways, 4-3-8
 - VFR Flights in Terminal Areas, 4-3-21
 - VFR Helicopter at Controlled Airports, 4-3-21
 - With Operating Control Tower, 4-3-1
 - Without Operating Control Tower, 4-3-7
 - Remote Airport Advisory (RAA), 3-5-1

[References are to page numbers]

- Remote Airport Information Service (RAIS), 3-5-1, 4-1-4
- Signs, 2-3-1, 2-3-19
 - Destination, 2-3-28
 - Direction, 2-3-25
 - Information, 2-3-29
 - Location, 2-3-23
 - Mandatory Instruction, 2-3-20
 - Runway Distance Remaining, 2-3-29
- Airport Reservations, 4-1-18
- Airport Surface Detection Equipment, 4-5-7
- Airport Surface Surveillance Capability, 4-5-7
- Airport Surveillance Radar, 4-5-7
- Airspace, 3-1-1
 - Basic VFR Weather Minimums, 3-1-1
 - Class D, 3-2-8
 - Class E, 3-2-9
 - Class G, 3-3-1
 - Controlled, 3-2-1
 - Advisories, Traffic, 3-2-1
 - Alerts, Safety, 3-2-1
 - Class A, 3-2-2
 - Class B, 3-2-2
 - Class C, 3-2-4
 - IFR Requirements, 3-2-1
 - IFR Separation, 3-2-1
 - Parachute Jumps, 3-2-2
 - Ultralight Vehicles, 3-2-2
 - Unmanned Free Balloons, 3-2-2
 - VFR Requirements, 3-2-1
 - Flight Levels, 3-1-2
 - General Dimensions, Segments, 3-1-1
 - Military Training Routes, 3-5-1
 - Other Areas, 3-5-1
 - Parachute Jumping, 3-5-5
 - Special Use, 3-4-1
 - Temporary Flight Restrictions, 3-5-2
 - Terminal Radar Service Areas, 3-5-9
 - VFR Cruising Altitudes, 3-1-2
 - VFR Routes, Published, 3-5-5
 - Class B Airspace, VFR Transition Routes, 3-5-7
 - VFR Corridors, 3-5-7
 - VFR Flyways, 3-5-5
- Airway, 5-3-15
- Airways, Course Changes, 5-3-17
- Alcohol, 8-1-1
- Alert, Safety, 4-1-10, 5-5-3
- Alert Areas, 3-4-2
- Alignment of Elements Approach Slope Indicator, 2-1-5
- Alphabet, Phonetic, 4-2-5
- ALS. *See* Approach Light Systems
- Altimeter
 - Density Altitude, 7-5-4
 - Errors, 7-2-3
 - Setting, 7-2-1
 - High Barometric Pressure, 7-2-4
 - Low Barometric Pressure, 7-2-4
- Altitude
 - Automatic Reporting, 4-1-16
 - Effects, 8-1-3
 - Hypoxia, 8-1-3
 - High Altitude Destinations, 5-1-27
 - Mandatory, 5-4-7
 - Maximum, 5-4-7
 - Minimum, 5-4-7
- Ambulance, Air, 4-2-4
- Amended Clearances, 4-4-2
- Approach
 - Advance Information, Instrument Approach, 5-4-4
 - Approach Control, 5-4-3
 - Clearance, 5-4-26
 - Contact, 5-4-62, 5-5-2
 - Instrument, 5-5-2
 - Instrument Approach Procedure, Charts, 5-4-5
 - Instrument Approach Procedures, 5-4-27
 - Low, 4-3-19
 - Minimums, 5-4-52
 - Missed, 5-4-56, 5-5-3
 - No-Gyro, 5-4-36
 - Option, 4-3-26
 - Overhead Approach Maneuver, 5-4-63
 - Precision, 5-4-35
 - Surveillance, 5-4-35
 - Visual, 5-4-61, 5-5-5
- Approach Control Service, VFR Arriving Aircraft, 4-1-2
- Approach Light Systems, 2-1-1
- Approaches
 - IFR, 4-1-6
 - Parallel Runways, ILS/RNAV/GLS, 5-4-37
 - Radar, 5-4-35
 - Timed, 5-4-33
- Area Navigation (RNAV), 5-3-16, 5-5-7 *See also* Area Navigation
- Area Navigation (RNAV) Routes, 5-3-16

[References are to page numbers]

ARFF (Aircraft Rescue and Fire Fighting) Emergency Hand Signals, 6-5-1

ARFF (Aircraft Rescue and Fire Fighting) Radio Call Sign, 6-5-1

Arresting Devices, Aircraft, 2-3-30

ARSR. *See* Air Route Surveillance Radar

ARTCC. *See* Air Route Traffic Control Centers

ASDE-X. *See* Airport Surface Detection Equipment-Model X

Ash, Volcanic, 7-5-7

ASOS. *See* Automated Surface Observing System

ASR. *See* Airport Surveillance Radar; Surveillance Approach

ASSC, 4-5-7

ATCRBS. *See* Air Traffic Control Radar Beacon System

ATCT. *See* Control Towers

ATIS. *See* Automatic Terminal Information Service

Attitude Heading Reference System (AHRS), 1-1-16

Authority, Statutory, 1-1-1

Automated Surface Observing System (ASOS), 4-3-32, 7-1-27

Automated Weather Observing System (AWOS), 4-3-32, 7-1-24

Automatic Altitude Reporting, 4-1-16

Automatic Dependent Surveillance-Broadcast Services, 4-5-14

Automatic Dependent Surveillance-Rebroadcast, 4-5-21

Automatic Flight Information Service (AFIS) - Alaska FSSs Only, 4-1-8

Automatic Terminal Information Service, 4-1-7

AWOS. *See* Automated Weather Observing System

B

Balloons, Unmanned, 7-5-2
Free, 3-2-2

Beacon
Aeronautical Light, 2-2-1
Code, 2-2-1
Marker, 1-1-10
Nondirectional Radio, 1-1-1

Beacons, Airport/Heliport, 2-1-14

Bird
Bird Strike
Reduction, 7-4-1
Reporting, 7-4-1
Hazards, 7-4-1
Migratory, 7-4-1

Bird/Other Wildlife Strike Reporting, Form. *See* Appendix 1

Braking Action Advisories, 4-3-13

Braking Action Reports, 4-3-13

Briefing, Preflight, 7-1-7

C

Call Signs
Aircraft, 4-2-3
Ground Station, 4-2-4

Carbon Monoxide Poisoning, 8-1-5

CAT. *See* Clear Air Turbulence

CDR. *See* Coded Departure Route

Changeover Points, 5-3-18

Charted Visual Flight Procedures, 5-4-62

Charts, Aeronautical, 9-1-1

Class A Airspace, 3-2-2
Definition, 3-2-2
Operating Rules, 3-2-2
Pilot/Equipment Requirements, 3-2-2

Class B Airspace, 3-2-2
ATC Clearances, 3-2-3
Definition, 3-2-2
Flight Procedures, 3-2-3
Mode C Veil, 3-2-3
Operating Rules, 3-2-2
Pilot/Equipment Requirements, VFR Operations, 3-2-2
Proximity Operations, 3-2-4
Separation, 3-2-3
VFR Transition Routes, 3-5-7

Class C Airspace, 3-2-4
Air Traffic Services, 3-2-5
Aircraft Separation, 3-2-5
Definition, 3-2-4
Operating Rules, 3-2-4
Outer Area, 3-2-5
Pilot/Equipment Requirements, 3-2-4
Secondary Airports, 3-2-6

[References are to page numbers]

- Class D Airspace, 3-2-8
 - Definition, 3-2-8
 - Operating Rules, 3-2-8
 - Pilot/Equipment Requirements, 3-2-8
 - Separation for VFR Aircraft, 3-2-9
 - Class E Airspace, 3-2-9
 - Definition, 3-2-9
 - Operating Rules, 3-2-9
 - Pilot/Equipment Requirements, 3-2-9
 - Separation for VFR Aircraft, 3-2-10
 - Types, 3-2-9
 - Vertical Limits, 3-2-9
 - Class G Airspace, 3-3-1
 - IFR Requirements, 3-3-1
 - VFR Requirements, 3-3-1
 - Clear Air Turbulence, 7-1-46
 - Clearance
 - Abbreviated IFR Departure, 5-2-3
 - Adherence, 4-4-5
 - Air Traffic, 5-5-1
 - Air Traffic Control, 4-4-1
 - Amended, 4-4-2
 - Approach, 5-4-26
 - IFR, VFR-on-Top, 4-4-4
 - IFR Flights, 4-4-5
 - Issuance, Pilot Responsibility, 4-4-4
 - Items, 4-4-1
 - Altitude Data, 4-4-2
 - Clearance Limit, 4-4-1
 - Departure Procedure, 4-4-1
 - Holding Instructions, 4-4-2
 - Route of Flight, 4-4-1
 - Pre-Taxi, 5-2-1
 - Prefix, 4-4-1
 - Taxi, 5-2-2
 - VFR Flights, 4-4-5
 - Void Times, 5-2-4
 - Clearances, Special VFR Clearances, 4-4-3
 - Clearing Procedures, Visual, 4-4-11
 - Coded Departure Route, 4-4-3
 - Cold Temperature Operations, 5-1-31
 - Pilot Responsibilities, 5-5-2, 5-5-3
 - Collision, Avoidance, Judgment, 8-1-8
 - Communication, Radio
 - Contact, Reestablishing, 6-4-2
 - Two-way Failure, 6-4-1
 - IFR Conditions, 6-4-1
 - Transponder Usage, 6-4-2
 - VFR Conditions, 6-4-1
 - Communications
 - ARTCC, 5-3-1
 - Additional Reports, 5-3-14
 - Position Reporting, 5-3-13
 - Distress, 6-3-1
 - Radio, 4-2-1
 - Phonetic Alphabet, 4-2-5
 - Release, 4-1-1
 - Urgency, 6-3-1
 - Conflict Alert, Aircraft, 4-1-11
 - Contact Approach, 5-4-62
 - Contact Procedures, 4-2-1
 - Initial Contact, 4-2-1
 - Control of Lighting Systems, 2-1-11
 - Control Towers, 4-1-1
 - Controlled Firing Areas, 3-4-2
 - Controller, Responsibility, 5-3-19, 5-4-62, 5-5-1
 - COP. *See* Changeover Points
 - CORONA, 7-5-9
 - Course Lights, 2-2-1
 - CVFP. *See* Charted Visual Flight Procedures
- D**
- Decompression Sickness, 8-1-4
 - Density Altitude, Effects, 7-5-4
 - Departure, Restrictions, 5-2-4
 - Departure Control, 5-2-5
 - Departures, Instrument, 5-5-7
 - Discrete Emergency Frequency, 6-5-1
 - Distance Measuring Equipment, 1-1-5, 1-1-10, 5-3-23
 - Distress, 6-3-1
 - Ditching Procedures, 6-3-3
 - DME. *See* Distance Measuring Equipment
 - Doppler Radar, 1-1-16
- E**
- Ear Block, 8-1-4
 - EFVS. *See* Enhanced Flight Vision Systems

[References are to page numbers]

ELT. *See* Emergency Locator Transmitters

Emergency, 6-1-1

- Air Piracy, 6-3-6
- Airborne Aircraft Inspection, 7-5-8
- Aircraft, Overdue, 6-2-5
- Body Signals, 6-2-6
- Ditching Procedures, 6-3-3
- Explosives Detection, FAA K-9 Team Program, 6-2-3
- Fuel Dumping, 6-3-7
- Inflight Monitoring and Reporting, 6-2-3
- Intercept and Escort, 6-2-1
- Locator Transmitters, 6-2-2
- Obtaining Assistance, 6-3-1
- Pilot Authority, 6-1-1
- Pilot Responsibility, 6-1-1
- Request Assistance Immediately, 6-1-1
- Search and Rescue, 6-2-4
- Services, 6-2-1
 - Radar Service for VFR Aircraft in Difficulty, 6-2-1
- Survival Equipment, 6-2-6
- Transponder Operation, 6-2-1
- VFR Search and Rescue Protection, 6-2-5

Emergency Locator Transmitter, 6-2-2

Enhanced Flight Vision Systems, 5-4-58

Escort, 6-2-1

Explosives, FAA K-9 Detection Team Program, 6-2-3

F

FAROS. *See* Final Approach Runway Occupancy Signal (FAROS)

Final Approach Runway Occupancy Signal (FAROS), 2-1-9

Final Guard, 3-5-1

FIS-B. *See* Flight Information Service-Broadcast

Fitness, Flight

- Alcohol, 8-1-1
- Emotion, 8-1-2
- Fatigue, 8-1-2
- Hypoxia, 8-1-3
- Stress, 8-1-2

Flight

- Aerobatic, 8-1-8
- Fitness, 8-1-1
- Illusions, 8-1-5
- Over National Forests, 7-4-1

- Over National Parks, 7-4-1
- Over National Refuges, 7-4-1
- Safety, Meteorology, 7-1-1
- Vision, 8-1-6

Flight Check Aircraft, 4-3-28

Flight Information Service-Broadcast, 4-5-19

Flight Information Services, 7-1-20

Flight Inspections Aircraft, 4-3-28

Flight Management System, 1-2-4, 5-1-12

Flight Plan

- Change, 5-1-29
 - Proposed Departure Time, 5-1-29
- Closing
 - DVFR, 5-1-29
 - VFR, 5-1-29
- Composite, VFR/IFR, 5-1-11
- DVFR Flights, 5-1-10
- Explanation of IFR, 5-1-16
- Explanation of VFR, 5-1-9
- Form 7233-1, 5-1-9, 5-1-16
- IFR, Canceling, 5-1-29
- IFR Flights, Domestic, 5-1-11
- VFR Flights, 5-1-7

Flight Restrictions, Temporary, 3-5-2

Flight Service Stations, 4-1-1

Flights, Outside the United States, 5-1-28

Flying, Mountain, 7-5-3

FMS. *See* Flight Management System

Forms

- Bird Strike Incident/Ingestion Report, Appendix 1-1
- Volcanic Activity Reporting Form, Appendix 2-1

Frequency, Instrument Landing System, 1-1-11

FSS. *See* Flight Service Stations

Fuel Dumping, 6-3-7

G

Gate Holding, 4-3-21

GBAS. *See* Ground Based Augmentation System

Glideslope, Visual Indicators, 2-1-1

Global Navigation Satellite System, 1-1-15, 5-1-12

- GNSS, 5-1-14

Global Positioning System, 1-1-16

GNSS. *See* Global Navigation Satellite System

[References are to page numbers]

GPS. *See* Global Positioning System

Graphical Forecasts for Aviation (GFA), 7-1-5

Ground Based Augmentation System (GBAS), 1-1-36

Ground Based Augmentation System (GBAS) Landing System (GLS), 1-1-34

Ground Station, Call Signs, 4-2-4

Ground Vehicle Operations, 4-1-6

Gulf of Mexico Grid System, 10-1-6

H

Half-Way Signs, 7-5-5

Hand Signals, 4-3-28

Hazard

Antenna Tower, 7-5-1

Bird, 7-4-1

Flight

Obstructions to Flight, 7-5-1

Potential, 7-5-1

VFR in Congested Areas, 7-5-1

Ground Icing Conditions, 7-5-13

Mountain Flying, 7-5-3

Overhead Wires, 7-5-2

Thermal Plumes, 7-5-14

Unmanned Balloons, 7-5-2

Volcanic Ash, 7-5-7

HDTA. *See* High Density Traffic Airports

Helicopter

IFR Operations, 10-1-1

Landing Area Markings, 2-3-19

VFR Operations at Controlled Airports, 4-3-21

Special Operations, 10-2-1

Wake Turbulence, 7-3-6

High Density Traffic Airports, 4-1-18

Hold, For Release, 5-2-4

Holding, 5-3-19

Holding Position Markings, 2-3-1, 2-3-12

for Instrument Landing Systems, 2-3-12

for Intersecting Taxiways, 2-3-12

Holding Position Signs, Surface Painted, 2-3-13

Hypoxia, 8-1-3

I

Icing Terms, 7-1-43

IFR, 4-4-4

Operations, To High Altitude Destinations, 5-1-27

Procedures, Use When Operating VFR, 5-1-2

IFR

Approaches, 4-1-6

Military Training Routes, 3-5-1

Separation Standards, 4-4-7

ILS. *See* Instrument Landing System

In-Runway Lighting, 2-1-6

Taxiway Centerline Lead-off Lights, 2-1-6

Taxiway Centerline Lead-On Lights, 2-1-6

Touchdown Zone Lighting, 2-1-6

Incident, Aircraft, Reporting, 7-6-1

Inertial Navigation System, 1-1-16

Inertial Reference Unit (IRU), 1-1-16, 5-1-12

Initial Contact, 4-2-1

INS. *See* Internal Navigation System

Instrument Departure Procedures (DP), 5-2-6

Instrument Landing System, 1-1-8

Category, 1-1-12

Compass Locator, 1-1-11

Course, Distortion, 1-1-12

Distance Measuring Equipment, 1-1-10

Frequency, 1-1-11

Glide Path, 1-1-10

Glide Slope, 1-1-10

Critical Area, 1-1-12

Holding Position Markings, 2-3-12

Inoperative Components, 1-1-12

Localizer, 1-1-9

Critical Area, 1-1-12

Locators, Compass, 1-1-8

Marker Beacon, 1-1-10

Minimums, 1-1-12

Instrument Meteorological Conditions (IMC), 5-2-6

Integrated Terminal Weather System, 4-3-13

Intercept, 6-2-1

Interception

Procedures, 5-6-8

Signals, 5-6-11

Interchange Aircraft, 4-2-4

International Flight Plan, IFR, Domestic, International, 5-1-17

[References are to page numbers]

International Flight Plan (FAA Form 7233-4)- IFR Flights (For Domestic or International Flights), 5-1-17

Intersection Takeoffs, 4-3-16

IR. *See* IFR Military Training Routes

IRU. *See* Inertial Reference Unit

ITWS. *See* Integrated Terminal Weather System

K

K-9 Explosives Detection Team, 6-2-3

L

LAHSO. *See* Land and Hold Short Operations

Land and Hold Short Lights, 2-1-6

Land and Hold Short Operations (LAHSO), 4-3-16

Landing

Minimums, 5-4-52

Priority, 5-4-63

Laser Operations, 7-5-10

Law Enforcement Operations

Civil, 5-6-10

Military, 5-6-10

LDA. *See* Localizer-Type Directional Aid

Leased Aircraft, 4-2-4

Light Signals, Traffic Control, 4-3-19

Lighting

Aeronautical Light Beacons, 2-2-1

Aids

Airport, 2-1-1

Approach Light Systems, 2-1-1

Control of Lighting Systems, 2-1-11

In-Runway Lighting, 2-1-6

Pilot Control of Airport Lighting, 2-1-11

Runway End Identifier Lights, 2-1-6

Taxiway Lights, 2-1-15

Airport/Heliport Beacons, 2-1-14

Airport, Radio Control, 4-1-6

Code Beacon, 2-2-1

Course, 2-2-1

Navigation, 2-2-1

Obstruction, 2-2-1

Line Up and Wait , 5-2-2

LLWAS. *See* Low Level Wind Shear Alert System

Local Airport Advisory (LAA), 3-5-1, 4-1-4

Local Flow Traffic Management Program, 5-4-3

Localizer-Type Directional Aid, 1-1-9

Locator, Compass, 1-1-11

Long Range Navigation, 1-1-16

LORAN. *See* Long Range Navigation

Low Approach, 4-3-19

Low Level Wind Shear Alert System (LLWAS), 4-3-13, 7-1-50

Low Level Wind Shear/Microburst Detection Systems, 4-3-13

LUAW. *See* Line Up and Wait

M

MAYDAY, 6-3-1

MEDEVAC, 4-2-4

Medical

Carbon Monoxide Poisoning, 8-1-5

Decompression Sickness, 8-1-4

Facts, Pilots, 8-1-1

Flight, Ear Block, 8-1-4

Illness, 8-1-1

Medication, 8-1-1

Sinus Block, 8-1-4

Meteorology, 7-1-1

ATC InFlight Weather Avoidance, 7-1-36

Automated Surface Observing System, 7-1-27

Categorical Outlooks, 7-1-16

Clear Air Turbulence, 7-1-46

Cloud Heights, Reporting, 7-1-40

Drizzle, Intensity, 7-1-41

FAA Weather Services, 7-1-2

ICAO, Weather Formats, 7-1-62

Icing, Airframe, 7-1-42

Inflight Aviation Weather Advisories, 7-1-9

Inflight Weather Broadcasts, 7-1-17

Microbursts, 7-1-46

National Weather Service, Aviation Weather Service, 7-1-1

Pilot Weather Reports, 7-1-41

Precipitation, Intensity, 7-1-40

Preflight Briefing, 7-1-7

Runway Visual Range, 7-1-38

Telephone Information Briefing Service, 7-1-17

Thunderstorms, 7-1-57

[References are to page numbers]

Flying, 7-1-58
 Transcribed Weather Broadcast, 7-1-17
 Turbulence, 7-1-45
 Visibility, Reporting, 7-1-40
 Weather, Radar Services, 7-1-32
 Weather Observing Programs, 7-1-24
 Wind Shear, 7-1-46
 Military NOTAMs, 5-1-3
 Military Operations Areas, 3-4-2
 Military Training Routes, 3-5-1
 IFR, 3-5-1
 VFR, 3-5-1
 Minimum, Fuel Advisory, 5-5-7
 Minimum Safe Altitudes, 5-4-8
 Minimum Turning Altitude (MTA), 5-3-18
 Minimum Vectoring Altitudes, 5-4-17
 Minimums
 Approach, 5-4-52
 Instrument Landing Systems, 1-1-12
 Landing, 5-4-52
 Missed Approach, 5-4-56
 MOA. *See* Military Operations Areas
 Mode C, 4-1-16
 Mountain Flying, 7-5-3
 Mountain Wave, 7-5-4
 Mountainous Areas, 5-6-13
 MSA. *See* Minimum Safe Altitudes
 MTA. *See* Minimum Turning Altitude (MTA)
 Multicom, 4-1-6
 MVA. *See* Minimum Vectoring Altitudes

N

National Forests, 7-4-1
 National Geospatial-Intelligence Agency (NGA),
 5-4-7
 National Parks, 7-4-1
 National Refuges, 7-4-1
 National Security, 5-6-1
 ADIZ, 5-6-1
 ADIZ Requirements, 5-6-2

Civil Aircraft Operations, 5-6-3
 Defense Area, 5-6-1
 Requirements, 5-6-1
 Territorial Airspace, 5-6-1
 National Security Areas, 3-4-2
 NAVAID
 Identifier Removal During Maintenance, 1-1-15
 Maintenance, 1-1-15
 Performance, User Report, 1-1-15
 Service Volumes, 1-1-5
 with Voice, 1-1-15
 Navigation, Aids, 1-1-1
 Nondirectional Radio Beacon, 1-1-1
 Radio, VHF Omni-directional Range, 1-1-1
 Navigation Reference System (NRS), 5-1-15
 Navigation Specifications (Nav Specs), 1-2-4
 Navigational
 Aids, Radio
 Distance Measuring Equipment, 1-1-5
 Doppler Radar, 1-1-16
 Identifier Removal During Maintenance, 1-1-15
 Instrument Landing System, 1-1-8
 Localizer-Type Directional Aid, 1-1-9
 Long Range Navigation, 1-1-16
 Navaid Service Volumes, 1-1-5
 NAVAIDs with Voice, 1-1-15
 Performance, User Report, 1-1-15
 Simplified Directional Facility, 1-1-13
 Tactical Air Navigation, 1-1-4
 VHF Omni-directional Range/Tactical Air
 Navigation, 1-1-4
 Inertial Navigation System, 1-1-16
 NDB. *See* Nondirectional Radio Beacon
 Near Midair Collision, 7-6-2
 NGA. *See* National Geospatial-Intelligence Agency
 NMAC. *See* Near Midair Collision
 Nondirectional Radio Beacon, 1-1-1
 Nonmovement Area Boundary Markings, 2-3-18
 NOTAM. *See* Notice to Airmen
 Notice to Airmen, 5-1-2
 FDC NOTAM, 5-1-3
 NOTAM Contractions, 5-1-6
 NOTAM D, 5-1-3
 Notice to Airmen System, 5-1-2
 Notices to Airmen Publication, NTAP, 5-1-3

O

Obstacle Departure Procedures, 5-2-6

[References are to page numbers]

Obstruction Alert, 4-1-11
 Operation Take-off, 4-1-1
 Operational Information System (OIS), 5-1-10
 Option Approach, 4-3-26

P

P-static, 7-5-9
 PAN-PAN, 6-3-1
 PAPI. *See* Precision Approach Path Indicator
 PAR. *See* Precision Approach; Precision Approach Radar
 Parachute Jumps, 3-2-2, 3-5-5
 Performance-Based Navigation (PBN), 1-2-1
 Phonetic Alphabet, 4-2-5
 Pilot
 Authority, 6-1-1
 Responsibility, 4-1-14, 4-4-1, 4-4-4, 5-4-62, 5-5-1, 6-1-1, 7-3-6
 Pilot Control of Airport Lighting, 2-1-11
 Pilot Visits to Air Traffic Facilities, 4-1-1
 Pilot Weather Reports, 7-1-41
 Piracy, Air, Emergency, 6-3-6
 PIREPs. *See* Pilot Weather Reports
 Pointer NOTAMs, 5-1-3
 Position Reporting, 5-3-13
 Pre-Departure Clearance Procedures, 5-2-1
 Precipitation Static, 7-5-9
 Precision Approach, 5-4-35
 Precision Approach Path Indicator, 2-1-4
 Precision Approach Radar, 4-5-7
 Precision Approach Systems, 1-1-35
 Preflight, Preparation, 5-1-1
 Priority, Landing, 5-4-63
 Procedure Turn, 5-4-29
 Limitations, 5-4-32
 Procedures
 Arrival, 5-4-1
 En Route, 5-3-1
 Instrument Approach, 5-4-27
 Interception, 5-6-8

Prohibited Areas, 3-4-1
 Publications, Aeronautical, 9-1-1
 Pulsating Visual Approach Slope Indicator, 2-1-5

R

Radar
 Air Traffic Control Radar Beacon System, 4-5-2
 Airport Route Surveillance Radar, 4-5-7
 Airport Surveillance Radar, 4-5-7
 Approach Control, 5-4-3
 Approaches, 5-4-35
 Capabilities, 4-5-1
 Doppler, 1-1-16
 Limitations, 4-5-1
 Monitoring of Instrument Approaches, 5-4-36
 Precision Approach, 4-5-7
 Precision Approach Radar, 4-5-7
 Surveillance, 4-5-7
 Vector, 5-5-3
 Radar Assistance to VFR Aircraft, 4-1-11
 Radar Beacon, Phraseology, 4-1-17
 Radar Sequencing and Separation, VFR Aircraft, TRSA, 4-1-13
 Radar Traffic Information Service, 4-1-9
 Radio, Communications, 4-2-1
 Altitudes, 4-2-6
 Contact Procedures, 4-2-1
 Directions, 4-2-6
 Inoperative Transmitter, 4-2-7
 Phonetic Alphabet, 4-2-5
 Receiver Inoperative, 4-2-7
 Speeds, 4-2-6
 Student Pilots, 4-2-4
 Technique, 4-2-1
 Time, 4-2-6
 Transmitter and Receiver Inoperative, 4-2-7
 VFR Flights, 4-2-8
 RCLS. *See* Runway Centerline Lighting
 Receiver, VOR, Check, 1-1-3
 REIL. *See* Runway End Identifier Lights
 REL. *See* Runway Entrance Lights
 Release Time, 5-2-4
 Remote Airport Advisory (RAA), 3-5-1
 Remote Airport Information Service (RAIS), 3-5-1, 4-1-4
 Required Navigation Performance (RNP), 5-4-23

[References are to page numbers]

Required Navigation Performance (RNP) Operations,
5-1-30, 5-5-7

Rescue Coordination Center

Air Force, 6-2-5

Alaska, 6-2-5

Coast Guard, 6-2-4

Joint Rescue, Hawaii, 6-2-5

Reservations, Airport, 4-1-18

Responsibility

Controller, 5-3-19, 5-4-62, 5-5-1

Pilot, 4-1-14, 4-4-1, 4-4-4, 5-4-62, 5-5-1, 6-1-1,
7-3-6

Restricted Areas, 3-4-1

Restrictions

Departure, 5-2-4

Flight, Temporary, 3-5-2

RIL. *See* Runway Intersection Lights (RIL)

RNAV. *See* Area Navigation

Route

Coded Departure Route, 4-4-3

Course Changes, 5-3-17

Route System, 5-3-15

Runway

Aiming Point Markings, 2-3-2

Centerline Markings, 2-3-2

Closed

Lighting, 2-3-18

Marking, 2-3-18

Condition Reports, 4-3-14

Demarcation Bar, 2-3-4

Designators, 2-3-2

Holding Position Markings, 2-3-12

Markings, 2-3-1

Separation, 4-4-10

Shoulder Markings, 2-3-3

Side Stripe Markings, 2-3-3

Signs, Distance Remaining, 2-3-29

Threshold Bar, 2-3-4

Threshold Markings, 2-3-3

Touchdown Zone Markers, 2-3-2

Runway

Edge Light Systems, 2-1-6

End Identifier Lights, 2-1-6

Entrance Lights, 2-1-7

Centerline Lighting System, 2-1-6

Status Light (RWSL) System, 2-1-7, 2-1-8

Runway Intersection Lights (RIL), 2-1-9

RWSL System, Runway Status Light (RWSL) System.
See Runway Status Light (RWSL) System

Runway, Visual Range, 7-1-38

Runways, Use, 4-3-8

RVR. *See* Runway Visual Range

S

Safety

Alert, 5-5-3

Alerts, 3-2-1

Aircraft Conflict, 3-2-1

Mode C Intruder, 3-2-1

Terrain/Obstruction, 3-2-1

Aviation, Reporting, 7-6-1

Seaplane, 7-5-6

Safety Alert, 4-1-10

Aircraft Conflict Alert, 4-1-11

Obstruction Alert, 4-1-11

Terrain Alert, 4-1-11

SAR. *See* Search and Rescue

SCAT-I DGPS. *See* Special Category I Differential
GPS

Scuba Diving, Decompression Sickness, 8-1-4

SDF. *See* Simplified Directional Facility

Seaplane, Safety, 7-5-6

Search and Rescue, 6-2-1, 6-2-4

Security Identification Display Area, 2-3-31

See and Avoid, 5-5-4

Separation

IFR, Standards, 4-4-7

Runway, 4-4-10

Visual, 4-4-10, 5-5-6

Wake Turbulence, 7-3-7

Sequenced flashing lights (SFL), 2-1-11

SFL. *See* Sequenced flashing lights

SIDA. *See* Security Identifications Display Area

Side-Step Maneuver, 5-4-52

Signs

Airport, 2-3-1

Half-Way, 7-5-5

Simplified Directional Facility, 1-1-13

Sinus Block, 8-1-4

Special Air Traffic Rules (SATR), 3-5-9

[References are to page numbers]

Special Category I Differential GPS (SCAT-I DGPS),
1-1-36

Special Flight Rules Area (SFRA), 3-5-9

Special Instrument Approach Procedures, 1-1-35,
5-4-29

Special Traffic Management Programs, 4-1-18

Special Use Airspace, 3-4-1
Alert Areas, 3-4-2
Controlled Firing Areas, 3-4-2
Military Operations Areas, 3-4-2
Prohibited Areas, 3-4-1
Restricted Areas, 3-4-1
Warning Areas, 3-4-1

Special Use Airspace (SUA) NOTAMs, 5-1-3

Special VFR Clearances, 4-4-3

Speed, Adjustments, 4-4-7, 5-5-4

Spoofing, 1-2-9

Standard Instrument Departures, 5-2-6

Standard Terminal Arrival, 5-4-1

STAR. *See* Standard Terminal Arrival

Surface Painted Holding Position Signs, 2-3-13

Surveillance Approach, 5-4-35

Surveillance Radar, 4-5-7

Surveillance Systems, 4-5-1

T

TACAN. *See* Tactical Air Navigation

Tactical Air Navigation, 1-1-4

TAF. *See* Aerodrome Forecast

Takeoff Hold Lights (THL), 2-1-8

Takeoffs, Intersection, 4-3-16

Taxi
Clearance, 5-2-2
During Low Visibility, 4-3-24

Taxiway
Centerline Markings, 2-3-7
Closed
Lighting, 2-3-18
Marking, 2-3-18
Edge Markings, 2-3-7
Geographic Position Markings, 2-3-10
Holding Position Markings, 2-3-12

Markings, 2-3-1, 2-3-7
Shoulder Markings, 2-3-7
Surface Painted Direction Signs, 2-3-10
Surface Painted Location Signs, 2-3-10

Taxiway Centerline Lead-Off Lights, 2-1-6

Taxiway Lights, 2-1-15
Centerline, 2-1-15
Clearance Bar, 2-1-15
Edge, 2-1-15
Runway Guard, 2-1-15
Stop Bar, 2-1-15

TCAS. *See* Traffic Alert and Collision Avoidance System

TDWR. *See* Terminal Doppler Weather Radar

TDZL. *See* Touchdown Zone Lights

TEC. *See* Tower En Route Control

Telephone Information Briefing Service, 7-1-17

Temporary Flight Restrictions, 3-5-2

Terminal Arrival Area (TAA), 5-4-9

Terminal Doppler Weather Radar (TDWR), 4-3-13,
7-1-51

Terminal Radar Service Areas, 3-5-9

Terminal Radar Services for VFR Aircraft, 4-1-12

Terminal Weather Information For Pilots System (TWIP), 7-1-56

Terrain Alert, 4-1-11

THL. *See* Takeoff Hold Lights

TIBS. *See* Telephone Information Briefing Service

Time
Clearance Void, 5-2-4
Release, 5-2-4

TIS. *See* Traffic Information Service

TIS-B. *See* Traffic Information Service-Broadcast

TLS. *See* Transponder Landing System

Touchdown Zone Lights (TDZL), 2-1-6

Tower, Antenna, 7-5-1

Tower En Route Control, 4-1-14

Traffic
Advisories, 5-5-5
Local Flow Traffic Management Program, 5-4-3

Traffic Advisory Practices, Airports Without Operating Control Towers, 4-1-2

Traffic Alert and Collision Avoidance System, 4-4-11

[References are to page numbers]

Traffic Control Light Signals, 4-3-19
 Traffic Information Service, 4-5-8
 Traffic Information Service (TIS), 4-4-12
 Traffic Information Service–Broadcast , 4-5-18
 Traffic Patterns, 4-3-2
 Transcribed Weather Broadcast, 7-1-17
 Transponder Landing System (TLS), 1-1-35
 Transponder Operation, 4-1-15
 Automatic Altitude Reporting, 4-1-16
 Code Changes, 4-1-16
 Emergency, 6-2-1
 Ident Feature, 4-1-16
 Mode C, 4-1-16
 Under Visual Flight Rules, 4-1-17
 VFR, 4-1-17
 Tri-Color Visual Approach Slope Indicator, 2-1-4
 TRSA. *See* Terminal Radar Service Areas
 Turbulence, Wake, 7-3-1
 Air Traffic Separation, 7-3-7
 Development and New Capabilities, 7-3-8
 Helicopters, 7-3-6
 Pilot Responsibility, 7-3-6
 Vortex Behavior, 7-3-2
 Vortex Generation, 7-3-1
 Vortex Strength, 7-3-1
 TWEB. *See* Transcribed Weather Broadcast
 TWIP. *See* Terminal Weather Information For Pilots System

U

Ultralight Vehicles, 3-2-2
 Uncontrolled Airports, IFR Clearances, 5-2-2
 Unicom, 4-1-6
 Unidentified Flying Object (UFO) Reports, 7-6-3
 Unmanned Aircraft, 7-5-2
 Urgency, 6-3-1

V

VASI. *See* Visual Approach Slope Indicator
 VDP. *See* Visual Descent Points
 Vector, Radar, 5-5-3

Vehicle Roadway Markings, 2-3-16
 Vertical Navigation, 5-1-12
 VFR Corridors, 3-5-7
 VFR Flights in Terminal Areas, 4-3-21
 VFR Flyways, 3-5-5
 VFR Military Training Routes, 3-5-1
 VFR Transition Routes, 3-5-7
 VFR-on-Top, 5-5-6
 VHF Omni-directional Range, 1-1-1
 Minimum Operational Network (MON), 1-1-2
 VHF Omni-directional Range/Tactical Air Navigation, 1-1-4
 Visual
 Approach, 5-4-61, 5-5-5
 Clearing Procedures, 4-4-11
 Glideslope Indicators, 2-1-1
 Separation, 4-4-10, 5-5-6
 Visual Approach Slope Indicator, 2-1-1
 Visual Climb Over Airport, 5-2-8
 Visual Descent Point, 5-4-19
 Visual Meteorological Conditions (VMC), 5-2-6
 VNAV. *See* Vertical Navigation
 VOCA. *See* Visual Climb Over Airport
 Void Times, Clearance, 5-2-4
 Volcanic, Ash, 7-5-7
 Volcanic Activity Reporting, Forms. *See* Appendix 2
 VOR *See also* VHF Omni-directional Range Receiver Check, 1-1-3
 VOR Receiver Checkpoint Markings, 2-3-16
 VORTAC. *See* VHF Omni-directional Range/Tactical Air Navigation
 VR. *See* VFR Military Training Routes

W

Waivers, 4-1-18
 Wake, Turbulence, 7-3-1
 Warning Areas, 3-4-1
 Weather
 Deviations in Oceanic Controlled Airspace, 7-1-37
 ICAO, Weather Formats, 7-1-62

[References are to page numbers]

Weather Reconnaissance Area (WRA), 3-5-9

WSP. *See* Weather System Processor

Weather System Processor (WSP), 4-1-19, 4-3-13,
7-1-52

U.S. Department
Of Transportation

**Federal Aviation
Administration**

800 Independence Ave., S.W.
Washington, D.C. 20591

FORWARDING SERVICE REQUESTED

Official Business
Penalty for Private Use \$300

